

ANCIENT MAGIC AND DIVINATION

The Daimon in Hellenistic Astrology

Origins and Influence

Dorian Gieseler Greenbaum

BRILL

Styx

The Daimon in Hellenistic Astrology

Ancient Magic and Divination

Editors

Tzvi Abusch
Ann K. Guinan
Nils P. Heeßel
Francesca Rochberg
Frans A. M. Wiggermann

VOLUME 11

The titles published in this series are listed at brill.com/amd



Roman coin, ca. 76 CE, reverse, depicting the Agathos Daimon wearing the double crown of Egypt, with caduceus (left) and wheat ear (right). From the author's collection

The Daimon in Hellenistic Astrology

Origins and Influence

By

Dorian Gieseler Greenbaum



BRILL

LEIDEN | BOSTON

Library of Congress Cataloging-in-Publication Data

Greenbaum, Dorian Gieseler.

The Daimon in Hellenistic astrology : origins and influence / by Dorian Gieseler Greenbaum.

pages cm. — (Ancient magic and divination, ISSN 1566-7952 ; volume 11)

Includes bibliographical references and index.

ISBN 978-90-04-30620-2 (hardback : alk. paper) — ISBN 978-90-04-30621-9 (e-book)

1. Astrology—History. 2. Hellenism. 3. Devil. 4. Demonology. 5. Daimon (The Greek word) I. Title.

BF1674.G74 2015

133.50938—dc23

2015028673

ISSN 1566-7952

ISBN 978-90-04-30620-2 (hardback)

ISBN 978-90-04-30621-9 (e-book)

Copyright 2016 by Koninklijke Brill nv, Leiden, The Netherlands.

Koninklijke Brill nv incorporates the imprints Brill, Brill Hes & De Graaf, Brill Nijhoff, Brill Rodopi and Hotei Publishing.

All rights reserved. No part of this publication may be reproduced, translated, stored in a retrieval system, or transmitted in any form or by any means, electronic, mechanical, photocopying, recording or otherwise, without prior written permission from the publisher.

Authorization to photocopy items for internal or personal use is granted by Koninklijke Brill nv provided that the appropriate fees are paid directly to The Copyright Clearance Center, 222 Rosewood Drive, Suite 910, Danvers, MA 01923, USA. Fees are subject to change.

This book is printed on acid-free paper.

In memoriam

Josèphe-Henriette Abry (18 July 1944–5 November 2008)

Giuseppe Bezza (21 September 1946–18 June 2014)



Contents

Acknowledgements	XI
List of Figures	XIV
List of Tables	XVI
Abbreviations	XVII
Astrological Symbols	XXIV

Introduction 1

1	Why the Daimon and Astrology?	2
2	The Multivalent δαίμων	4
3	Astrology and the Daimon	5
4	The Plan of the Book	11

PART 1

Daimon and Fortune

1	Kindled Spirits: The Daimon, Plutarch and Vettius Valens	17
1	Plutarch and the Daimon	19
2	The Daimon, Fate, Providence and Astrology	28
3	Vettius Valens' Daimon and Providence	33
2	Keeping in Good Spirits: The Places of Good Daimon and Fortune in Astrology	46
1	Why Tyche and Daimon? Some Cultural and Historical Background	47
2	The Astrological Places of Good Daimon and Good Fortune	50
3	Twists of Fate: Daimon, Fortune and Astrology in Egypt and the Near East	77
1	The Agathos Daimon and Agathe Tyche in Egypt (and Beyond)	77
2	Shai, the Agathos Daimon and Fate	95
3	Mesopotamian and Egyptian 'Fate'	108
4	Hie Thee to Hell: The Place of the Bad Daimon	116
1	A Brief History of Bad Daimons	116
2	The Places of Bad Daimon and Bad Fortune in Astrology	140

PART 2

Gods and Daimons

- 5 **Divergent Paths: Daimons and Astrology in Gnosticism and Mithraism** 159
- 1 Religious Dualism in the Air 160
 - 2 Daimons and Astrology in Gnosticism 164
 - 3 Daimons and Astrology in Mithraism 181
- 6 **Ambivalent Daimons and Astrology** 194
- 1 Daimons and Astrology in the Magical Papyri 195
 - 2 Daimons and Astrology in the *Hermetica* 209
 - 3 Decans and Daimons 213
 - 4 Gods and Daimons in Astrological Decans 223
- 7 **Porphyry, the *Oikodespotēs* and the Personal Daimon** 236
- 1 Neo-Platonism and the Personal Daimon 237
 - 2 The Astrological Personal Daimon 255
 - 3 Porphyry's Astrological Treatise 266

PART 3

Lots and the Daimon

- 8 **Allotment, the Daimon and Astrology** 279
- 1 Lots in Hellenistic Culture 280
 - 2 Lot Doctrine in Astrology 286
 - 3 Some Reflections 299
- 9 **Endowment and Chance: The Lots of Fortune and Daimon** 303
- 1 The Lots and their Luminaries 305
 - 2 Calculating the Lots of Fortune and Daimon 307
 - 3 Variation on a Theme: The Lot of Basis 309
 - 4 The Lots in Interpretation: Descriptions 310
 - 5 The Lots in Interpretation: Case Studies 314
 - 6 Lot Calculation and the Doctrine of Sect 329
 - 7 The Lots and Length of Life 330
 - 8 Conclusions 335

10	'Parents of Human Civilisation': The Lots of Love and Necessity	339
	Prologue: Macrobius's Caduceus	340
1	Eros and Ananke in Greek Religion and Philosophy: An Overview	342
2	The Astrological Lots of Eros and Necessity	356
3	Interpreting the Lots in Context	378
	Epilogue: Caduceus Redux	384
	Conclusion	389
1	Weaving the Tapestry	389
2	Following the Threads	390
3	Tying Off the Threads	395

Appendices

	Appendix 1.A: Basic Techniques of Hellenistic Astrology	399
	Appendix 2.A: Manilius, <i>Astronomica</i> : Eleventh and Fifth Places	415
	Appendix 2.B: Paulus Alexandrinus, <i>Introduction</i> : Fifth and Eleventh Places	417
	Appendix 3.A: Portions of the Isis Aretalogy from Kyme	420
	Appendix 4.A: Prayer from the <i>Hygromanteia</i> of Solomon	422
	Appendix 7.A: Original and Literary Charts that Mention an <i>Oikodespotēs</i>	423
	Appendix 7.B: A Comparison of Antiochus, <i>Introduction</i> , Chapter 28 and Porphyry, <i>Introduction</i> , Chapter 30	439
	Appendix 7.C: Porphyry, <i>Introduction to the Tetrabiblos</i> , Chapter 30	442
	Appendix 8.A: Vettius Valens' Lot Formulae	446
	Appendix 8.B: Lots according to Antiochus of Athens	447
	Appendix 8.C: The Fifth Consideration, on Lots: Rhetorius, Chapter 54, 'Investigation of Chart Factors'	450
	Appendix 8.D: Lots according to Paulus Alexandrinus and Olympiodorus	455
	Appendix 9.A: Julius Firmicus Maternus on the 'Places' (Lots) of Fortune and Daemon	460
	Appendix 9.B: Valens' Melothesia from the Lots of Fortune and Daimon	468
	Appendix 9.C: Planetary Years for Time Lords in Vettius Valens (Minor Years of the Planets)	470
	Appendix 10.A. Orphic Hymns to Eros, Tyche and Daimon	472

Appendix 10.B: Formulae for the Lots of Eros and Necessity	475
Appendix 10.C: Extant Charts Using the Lots of Eros and Necessity	477
Bibliography	483
General Index	530
Selected Citations Index	551
Selected Word Index	569

Acknowledgements

The long road from dissertation to book is made easier by the welcome assistance of those one meets along the way. I feel very fortunate to have met so many who have been so generous with their time, knowledge and support. My first thanks must go to my Ph.D. supervisor at the Warburg Institute, Charles Burnett, whose impeccable scholarship, kindness, generosity and intellectual curiosity have been a model for me. Next I thank Francesca Rochberg, who promoted my work for the Magic and Divination Series at Brill, and who is not only a friend but an exemplar of scholarly ingenuity, resourcefulness and creativity. Third, I express great gratitude to Stephan Heilen, a leading scholar in the history of astrology today, for his friendship, stimulating discussions on arcane topics of astrology and assistance with Greek translation, which saved me from many an embarrassing error. He has also been a ready resource for manuscript pages when I needed them. Of those who have gone above and beyond in support, I must also thank Micah Ross, who has been my resource for Demotic material, is always willing to read drafts with a critical eye, and has provided advice on several of the chapters in this book.

In addition to these fine scholars, I owe thanks and gratitude to those who have helped to supplement my knowledge and stimulate my thinking in fields both within and outside my areas of specific expertise. The interdisciplinary nature of this study required a steep learning curve. The expertise of those in related fields was essential, and the conversations with those in my field invaluable. These include Joette Abry, Peter Adamson, Crystal Addey, Giuseppe Bezza, Bernadette Brady, Marcia Butchart, Nicholas Campion, Claire Chandler, Geoffrey Cornelius, Darby Costello, Joseph Crane, Patrick Curry, Susanne Denningmann, Leo Depuydt, Meira Epstein, Guido Giglioni, Joseph Greene, Liz Greene, Darrelyn Gunzburg, Bink Hallum, Robert Hand, Nadine Harris, Maggie Hyde, Joanna Komorowska, Marilyn Lawrence, Daryn Lehoux, Attilio Mastrocinque, Garry Phillipson, Robert Sharples, Harold Tarrant and James Wilberding. Naturally, any errors that remain in spite of their assistance and good advice are my own.

I must also thank the anonymous readers at Brill for helpful advice and constructive criticism. In addition I am grateful to Katelyn Chin, my editor at Brill, for all her help.

Alexander Jones, Joachim F. Quack, James Wilberding and Andreas Winkler generously provided me with their unpublished texts. I thank them all.

Thanks also goes to Nicholas Campion and the University of Wales Trinity Saint David, my employers, for providing access to electronic databases that make my life as a scholar much easier.

The intellectual atmosphere at the Warburg Institute provides an amazing environment for research, and I thank my fellow students, colleagues and staff for their advice and support, especially Cornelia Linde and Ulrike Kern. The Institute and its library is the best place on earth to work as a scholar.

For permission to reprint from copyrighted material, I thank the following.

Katharina Legutke, De Gruyter, for generous permission to quote from the following critical editions: Abū Ma'shar, *De revolutionibus nativitatum*, ed. David Pingree, Leipzig: B. G. Teubner, 1968; Hephaestio, *Hephaestio Thebanus. Apotelesmaticorum libri tres*, ed. David Pingree, 2 vols, Leipzig: B. G. Teubner, 1973; Macrobius, *Saturnalia*, 2nd ed., ed. James Willis, Macrobius Vol. 1, Stuttgart/Leipzig: B. G. Teubner, 1994; Olympiodorus, *Eis ton Paulon <Heliodorou>. Heliodori, ut dicitur, in Paulum Alexandrinum Commentarium*, ed. Emilie Boer, Leipzig: B. G. Teubner, 1962; Paulus Alexandrinus, *Elementa Apotelesmatica*, ed. Emilie Boer, Leipzig: B. G. Teubner, 1958; *Papyri Graecae Magicae. Die griechischen Zauberpapyri*, 2nd ed., ed. and trans. Karl Preisendanz, 2 vols., Stuttgart: B. G. Teubner, 1973–1974; Vettius Valens, *Anthologiarum libri novem*, ed. David Pingree, Leipzig: B. G. Teubner, 1986.

Shannon McCullough, Johns Hopkins University Press, for permission to quote from *The Orphic Hymns*, trans., intro. and annot. Apostolos N. Athanassakis and Benjamin M. Wolkow, Baltimore: Johns Hopkins University Press, 2013.

Ann-Grace Martin, Columbia University Press, for permission to quote from Macrobius, *The Saturnalia*, trans. and annot. Percival Vaughan Davies, New York: Columbia University Press, 1969.

Nicole Tilford, The Society of Biblical Literature, for kind permission to quote from Iamblichus, *On the Mysteries*, ed., trans. and comm. Emma C. Clarke, John M. Dillon and Jackson P. Hershbell. Atlanta: Society of Biblical Literature, 2003.

Mary McDonald, The American Philosophical Society, for kind permission to quote from and reproduce an image from O. Neugebauer and H. B. Van Hoesen, *Greek Horoscopes*. Philadelphia: The American Philosophical Society, 1959, repr. 1987; and to quote from Alexander Jones, ed., trans. and comm., *Astronomical Papyri from Oxyrhynchus*. 2 vols. Philadelphia: American Philosophical Society, 1999.

Terry Miosi, Lyn Green and the Society for the Study of Egyptian Antiquities for kind permission to quote from F. T. Miosi, 'God, Fate and Free Will in Egyptian Wisdom Literature', in *Studies in Philology in Honour of Ronald James Williams: A Festschrift*, eds Gerald E. Kadish and Geoffrey E. Freeman, 69–111, Vol. 3, SSEA Publications, Toronto: Benben Publications, 1982.

Permission to reproduce other images will appear with the image in the text.

In addition, I must mention, again, two scholars whom I can no longer thank in person, but whose advice was invaluable and whose scholarship and friendship will be missed, Josèphe-Henriette Abry and Giuseppe Bezza. This volume is dedicated to their memory.

Finally, this book could not have been written without the support of my family, especially my husband, Don. He has cheerfully put up with more than he should have had to during the years it has taken to write this book, and I feel exceedingly lucky and grateful that he is in my life.

Dorian Gieseler Greenbaum

Duxbury, Massachusetts and London

May 2015

List of Figures

- 1.1 The Daimon and Fortune places in the astrological chart 7
- 1.2 The Lots of Fortune and Daimon in a chart 8
- 1.1 The three levels of fate (*Heimarmenē*) 30
- 1.2 The three levels of providence 31
- 1.3 Fate included in providence 32
- 1.4 Probable birthchart of Vettius Valens 35
- 2.1 The eleventh and fifth places 51
- 2.2 Chart illustrating triplicity lords and fortune in Dorotheus 63
- 2.3 Firmicus's chart of 'Homer' 71
- 3.1 Coin from Alexandria representing an Altar (perhaps to Agathos Daimon), with snakes on either side 81
- 3.2 (left and right) Limestone reliefs depicting Agathos Daimon and Isis/Thermouthis. Graeco-Roman Museum, Alexandria, nos. 3179 and 3180 82
- 3.3 Roman coin, ca. 76 CE, reverse, depicting the Agathos Daimon wearing the *skhent* (double) crown, with caduceus (left) and wheat ear (right) 86
- 3.4 The Tyche Zodiac from Khirbet et-Tannur 93
- 3.5 The weighing of the heart in the Book of the Dead, from the Papyrus of Ani 97
- 4.1 Detail of the Funerary Papyrus of Taminiu, showing demons (with knives). Thebes, 3rd Intermediate Period, ca. 950 BCE 120
- 4.2 Cadent places 141
- 4.3 The Sign Melothesia in P. Mich, inv. 1, 149 152
- 5.1 Beck's proposed genealogy of Antiochus of Athens 184
- 5.2 Traditional *Thema Mundi*, as in Firmicus 186
- 5.3 Antiochus's alternative *Thema Mundi* 189
- 5.4 The Birth of Mithras from a Cosmic Egg (Housesteads Monument, Hadrian's Wall [CIMRM 860]) 191
- 8.1 Manilius's Circle of Athla, or places from the Lot of Fortune 292
- 9.1 The Lots of Fortune and Daimon in a diurnal chart 308
- 9.2 Circular chart depiction of OMM 134 316
- 9.3 Chart using places from the Lot of Fortune 318
- 9.4 Chart using places from the Lot of Daimon 320
- 9.5 Chart illustrating *Aphesis* from Fortune and Daimon 323
- 9.6 Chart illustrating profections from Fortune and Daimon 325
- 9.7 Chart illustrating the Lot of Basis 328

- 9.8 Equal distance of the lots from the Ascendant 334
- 9.9 An isosceles triangle with lots and Ascendant 338
- 10.1 A Caduceus 339
- 10.2 Paulus's Lot of Eros in a diurnal chart 361
- 10.3 Paulus's Lot of Necessity in a diurnal chart 362
- 10.4 Firmicus's Lots of Eros and Necessity in a diurnal chart 364
- 10.5 Valens' Lots of Eros and Necessity in a diurnal chart 366
- 10.6 Chart no. 138/161, *Greek Horoscopes*, nocturnal chart 368
- 10.7 Chart no. 338, *Greek Horoscopes*, nocturnal chart 370
- 10.8 Chart no. 4277, *Astronomical Papyri from Oxyrhynchus*, nocturnal chart 372
- 10.9 Nativity of Constantine VII Porphyrogenitus, text positions 373
- 10.10 Nativity of Constantine VII Porphyrogenitus, calculated positions from textual clues 375
- 10.11 Hypothetical Olympiodorus chart 377
- 10.12 Abū Ma'shar chart, from *De revolutionibus nativitatum* 3,1 378
- 10.13 Mithraic Kronos representing Aion or Boundless Time, Mithraeum at Ostia, 190 CE 385
- I.1 Places of the chart 401
- I.2 Sect 403
- I.3 Familiarities between signs 405
- I.4 Aspects 406
- I.5 Planetary joys and aspects to the hour-marker 406
- I.6 Planetary house rulers 408
- I.7 The Lots of Fortune and Daimon in a diurnal chart 409
- I.8 Traditional *thema mundi*, as in Firmicus 414

Drawings of the following charts from *Greek Horoscopes*: (enumeration as in Appendix 7.A)

- 1 No. 15/22 (duplication of Fig. 9, p. 18 in *Greek Horoscopes*; and modern depiction) 423
- 2 No. 81 424
- 3 No. 95 425
- 4 No. 137 (a, b, c) 426
- 5 No. 138/161 427
- 7 No. L40 429
- 8 No. L76 430
- 9 No. L113,IV 432
- 10 No. L482 433
- 12 No. L487 437

List of Tables

- 4.1 Planetary days and hours 135
- 4.2 Names and descriptions of the sixth and twelfth places 143
- 5.1 Six archon lists 166
- 5.2 Planetary orders 168
- 5.3 Archon names and their faces in the *Apocryphon of John*, with corresponding planet, and zodiac sign from the Dodekaoros 172
- 5.4 Assignments of aeons-angels-*exousiai* to the zodiac and planets 174
- 6.1 Manilius's system of decans 225
- 7.1 Summary of meanings of *Oikodespotēs* 265
- 8.1 Comparison of Martianus Capella and Manilius 295
- 8.2 'Hermetic' lots in Paulus and Olympiodorus 297
- 9.1 Attributions of the Sun/Lot of Daimon and the Moon/Lot of Fortune 306
- 1.1 Signs of the quadruplicities 402
- 1.2 Signs of the elemental triplicities 403
- 1.3 Triplicity lords 408
- 1.4 Dignities with houses, exaltations, Dorothean triplicities, Egyptian bounds and decanic faces 410
- 1.5 Years of the planets 411

Abbreviations

1 Texts of Ancient Astrologers

- CCAG *Catalogus Codicum Astrologorum Graecorum*. Edited by Franz Cumont et al. 12 vols. Brussels: Henri Lamertin, 1898–1953
- Antiochus, *Intr.* Antiochus of Athens, *Introduction: Summaries of Books 1 and 2*, CCAG VIII/3, 111–119
- Antiochus, *Thes.* Antiochus of Athens, *Thesaurus*, CCAG I, 140–164; CCAG VII, 107–128
- Anubio Anubio, *Carmen Astrologicum Elegiacum*. Edited by Dirk Obbink. Munich/Leipzig: K. G. Saur, 2006
- Balbillus CCAG VIII/4, 235–238
- Dorotheus Dorotheus of Sidon, *Carmen Astrologicum*. Edited by David Pingree. Leipzig: B. G. Teubner, 1976
- Firmicus, *Mathesis* Julius Firmicus Maternus, *Matheseos libri VIII*. Edited by Wilhelm Kroll, Franz Skutsch and Konrat Ziegler. 2 vols. Leipzig: B. G. Teubner, 1897–1913
- Hephaestio Hephaestio, *Hephaestio Thebanus. Apotelesmaticorum libri tres*. Edited by David Pingree. 2 vols. Leipzig: B. G. Teubner, 1973
- Liber Hermetis* Hermes Trismegistus, *De Triginta Sex Decanis*. Edited by Simonetta Feraboli. *Hermes Latinus* Tome IV, Part 1 (Corpus Christianorum). Turnhout: Brepols, 1994
- Manetho (astrologer) Robert Lopilato, ‘The “Apotelesmatika” of Manetho’, Ph.D. thesis, Brown University 1998
- Manilius (Goold) Marcus Manilius, *Astronomica*. Edited and translated by George P. Goold. Loeb Classical Library. Cambridge, MA/London: Harvard University Press, 1977, repr. 1997
- Nechepso and Petosiris Nechepso and Petosiris, *Fragmenta magica*. Edited by E. Riess. In *Philologus*, Suppl. Bd. 6, pt. 1. Göttingen, 1892
- Olympiodorus, *Commentary on Paulus* Olympiodorus, *Eis ton Paulon <Heliodorou>. Heliodori, ut dicitur, in Paulum Alexandrinum Commentarium*. Edited by Emilie Boer. Leipzig: B. G. Teubner, 1962

- Paulus, *Introduction* Paulus Alexandrinus, *Elementa Apotelesmatica*. Edited by Emilie Boer. Leipzig: B. G. Teubner, 1958
- Porphyry, *Introduction to the Tetrabiblos* (or *Introduction*) Porphyry, *Introductio in Tetrabiblum*. Edited by Emilie Boer and Stephan Weinstock. In CCAG V/4, 190–228
- Ptolemy, *Tetrabiblos* (or *Tetr.*) Claudius Ptolemy, *Ἀποτελεσματικά. Opera quae exstant omnia*, vol. III 1. Edited by Wolfgang Hübner. Stuttgart/Leipzig: B. G. Teubner, 1998
- Rhetorius Rhetorius, *Compendium*, in CCAG VIII/4, 115–224 (≈ ms. Pingree); ≈ *Compendium astrologicum secundum epitomen in cod. Paris. gr. 2425 servatam*, eds. David Pingree and Stephan Heilen, Berlin/New York forthcoming.
- Serapion Serapion of Alexandria, *The Proper and Derived Uses of the Configurations of the Stars*, in CCAG VIII/4, 225–232
- Thrasyllus *Summary of the Tablet of Thrasyllus to Hierocles*, CCAG VIII/3, 99–101
- Valens Vettius Valens, *Anthologiarum libri novem*. Edited by David Pingree. Leipzig: B. G. Teubner, 1986
- Valens (Kroll) Vettius Valens, *Anthologiarum libri*. Edited by Wilhelm Kroll. Berlin: Weidmann, 1908

2 Other Books, Texts, Series, Databases and Authors

(Ancient text abbreviations mostly following the *Oxford Classical Dictionary*, eds Simon Hornblower and Anthony Spawforth (Oxford/New York: Oxford University Press, 1996)

- AG Auguste Bouché-Leclercq, *L'astrologie grecque*. Paris: E. Leroux, 1899
- AM Giuseppe Bezza, *Arcana Mundi: Antologia del pensiero astrologico antico*. 2 vols. Milan: Rizzoli, 1995
- ANRW *Aufstieg und Niedergang der römischen Welt*. Berlin/New York: W. de Gruyter, 1973–
- APO Alexander Jones, ed., trans. and comm., *Astronomical Papyri from Oxyrhynchus*. 2 vols. Philadelphia: American Philosophical Society, 1999
- ApJohn *The Apocryphon of John*

- Betz, ed., *GMP* Hans Dieter Betz, ed., *The Greek Magical Papyri in Translation, including the Demotic Spells*. Vol. 1, *Texts*. Chicago/London: University of Chicago Press, 1986, 2nd. ed. 1992, repr. 1996
- CAD* *Chicago Assyrian Dictionary*. Edited by Martha T. Roth et al., 21 vols, Chicago: Oriental Institute of the University of Chicago, 1956–2010, <http://oi.uchicago.edu/research/publicationsassyrian-dictionary-oriental-institute-university-chicago-cad>
- CDD* *Chicago Demotic Dictionary*. Edited by Janet Johnson. <http://oi.uchicago.edu/research/pubs/catalog/cdd/> (rev. 28 April 2008)
- CH* *Corpus Hermeticum*
- Chantraine Pierre Chantraine, *Dictionnaire étymologique de la langue grecque: histoire des mots*. 4 vols. Paris: Klincksieck, 1968–1980
- CIMRM* M. J. Vermaseren, *Corpus inscriptionum et monumentorum religionis Mithriacae*. 2 vols. The Hague: M. Nijhoff, 1956–1960
- CIS* *Corpus Inscriptionum Semiticarum*
- Crum, *CD* W. E. Crum, *A Coptic Dictionary*. Oxford: Clarendon Press, 1939
- DDD* Karel van der Toorn, Bob Becking and Pieter Willem van der Horst, eds, *Dictionary of Deities and Demons in the Bible*. 2nd rev. ed. Leiden/Boston/Grand Rapids, MI: Brill; Eerdmans, 1999
- De antro* Porphyry, *De antro nympharum (On the Cave of the Nymphs in the Odyssey)*
- D-K Hermann Diels and Walther Kranz, *Die Fragmente der Vorsokratiker: griechisch und deutsch*. 6th ed. 3 vols. Berlin: Weidmann, 1951, repr. 1966
- DM* Iamblichus, *De mysteriis*
- DNP* Hubert Cancik and Helmut Schneider, eds, *Der Neue Pauly Enzyklopädie der Antike*. 16 vols. Stuttgart: J. B. Metzler, 1996–2003
- EAT* O. Neugebauer and Richard A. Parker, *Egyptian Astronomical Texts*. (1. *The Early Decans*. 2. *The Ramesside Star Clocks*. 3. *Decans, Planets, Constellations and Zodiacs*). 4 vols. Providence: Brown University Press, 1960–1969
- FAT II* *Forschungen zum Alten Testament 2. Reihe*

- Frisk Hjalmar Frisk, *Griechisches etymologisches Wörterbuch*. 3 vols. Heidelberg: Winter, 1960–1972
- GH Otto Neugebauer and Henry Bartlett Van Hoesen, *Greek Horoscopes*, Philadelphia: The American Philosophical Society, 1959, repr. 1987
- HAMA Otto Neugebauer, *A History of Ancient Mathematical Astronomy*. 3 vols. Berlin/Heidelberg/ New York: Springer-Verlag, 1975
- HGP William Keith Chambers Guthrie, *A History of Greek Philosophy*. 6 vols. Cambridge: Cambridge University Press, 1962–1981
- HN Pliny the Elder, *Natural History (Naturalis Historia)*
- Holy Book *Holy Book of the Great Invisible Spirit* (a.k.a. *Gospel of the Egyptians*)
- Adv. haer. Irenaeus, *Against Heresies*
- KBo Figulla, H. H., E. Forrer, and E. F. Weidner, eds, *Keilinschrifttexte aus Boghazköi*. Vol. I–IV. Leipzig: J. C. Hinrichs'sche Buchhandlung, 1923.
- KSZ Kroll, Skutsch and Ziegler, in Julius Firmicus Maternus, *Matheseos libri VIII*. Edited by Wilhelm Kroll, Franz Skutsch and Konrat Ziegler. 2 vols. Leipzig: B. G. Teubner, 1897–1913
- Lewis and Short Charlton T. Lewis and Charles Short, *A Latin Dictionary*, Oxford: Clarendon Press, 1879, repr. 1996
- LIMC *Lexicon Iconographicum Mythologiae Classicae*. 8 vols. Zurich/Munich: Artemis Verlag, 1981–1999
- LSJ Henry George Liddell, Robert Scott and Henry Stuart Jones, *A Greek-English Lexicon*, 9th ed. Oxford: Clarendon Press, 1996
- LXX Septuagint
- MIFAO Mémoires de l'Institut français d'archéologie orientale
- NT New Testament
- OF *Orphicorum fragmenta*, ed. Otto Kern. Berlin: Weidmann, 1922
- OLA Orientalia Lovaniensia Analecta
- OT Old Testament
- PAT *Palmyrene Aramaic Texts*
- PE Eusebius, *Praeparatio Evangelica*
- PGM Papyri Graecae Magicae
- Phil. Orac. Porphyry, *Philosophy from Oracles*

<i>PS</i>	<i>Pistis Sophia</i>
<i>RE</i>	<i>Paulys Realencyclopädie der classischen Altertumswissenschaft</i> . Stuttgart: Metzler, 1893–
<i>SAACT</i>	State Archives of Assyrian Cuneiform Texts
<i>SAPERE</i>	<i>Scripta Antiquitatis Posterioris ad Ethicam Religionemque pertinentia</i>
<i>SH</i>	<i>Stobaei Hermetica</i>
<i>Test. Sal.</i>	<i>Testament of Solomon</i>
<i>Theol. Graec.</i>	Cornutus, <i>Theologiae Graecae compendium</i>
<i>TLG</i>	<i>Thesaurus Linguae Graecae</i> . Online database of texts in Greek, at http://www.tlg.uci.edu/
<i>TLL</i>	<i>Thesaurus Linguae Latinae, editus auctoritate et consilio academiarum quinque Germanicarum Berlinensis, Gotttingensis, Lipsiensis, Monacensis, Vindobonensis</i> . Leipzig: B. G. Teubner, 1900–
<i>Urkunden II</i>	Kurt Sethe, ed., <i>Urkunden des aegyptischen Altertums</i> . Band II, <i>Hieroglyphische Urkunden der griechisch-römischen Zeit</i> , Heft III. Leipzig: J. C. Hinrichs'sche Buchhandlung, 1904–1916
<i>Urkunden IV</i>	Kurt Sethe, ed., <i>Urkunden des ägyptischen Altertums</i> . Band IV, <i>Urkunden der 18. Dynastie</i> . Leipzig: J. C. Hinrichs'sche Buchhandlung, 1906–1957
<i>Wb</i>	Adolf Erman and Hermann Grapow, <i>Wörterbuch der aegyptischen Sprache</i> , 6 vols + Suppl., Leipzig: Akademie Verlag, 1926–1953

3 Periodicals (*mostly following L'Année Philologique*)

<i>AC</i>	<i>L'antiquité classique</i>
<i>AJA</i>	<i>American Journal of Archaeology</i>
<i>AJPh</i>	<i>American Journal of Philology</i>
<i>AncW</i>	<i>The Ancient World</i>
<i>AoF</i>	<i>Altorientalische Forschungen</i>
<i>AOF</i>	<i>Archiv für Orientforschung</i>
<i>ArchRW</i>	<i>Archiv für Religionswissenschaft</i>
<i>ARG</i>	<i>Archiv für Religionsgeschichte</i>
<i>BABesch</i>	<i>Bulletin Antieke Beschaving</i>
<i>BASOR</i>	<i>Bulletin of the American Schools of Oriental Research</i>
<i>BIFAO</i>	<i>Bulletin de l'Institut français d'archéologie orientale</i>

<i>BICS</i>	<i>Bulletin of the Institute of Classical Studies</i>
<i>Cd'E</i>	<i>Chronique d'Égypte</i>
<i>CPh</i>	<i>Classical Philology</i>
<i>CQ</i>	<i>Classical Quarterly</i>
<i>GM</i>	<i>Göttinger Miszellen. Beiträge zur ägyptologischen Diskussion</i>
<i>HThR</i>	<i>Harvard Theological Review</i>
<i>IJCT</i>	<i>International Journal of the Classical Tradition</i>
<i>JANER</i>	<i>Journal of Ancient Near Eastern Religions</i>
<i>JAS</i>	<i>Journal of the Royal Asiatic Society</i>
<i>JAOS</i>	<i>Journal of the American Oriental Society</i>
<i>JEA</i>	<i>Journal of Egyptian Archaeology</i>
<i>JHA</i>	<i>Journal for the History of Astronomy</i>
<i>JHS</i>	<i>Journal of Hellenic Studies</i>
<i>JNES</i>	<i>Journal of Near Eastern Studies</i>
<i>JPh</i>	<i>Journal of Philosophy</i>
<i>JRS</i>	<i>Journal of Roman Studies</i>
<i>JWI</i>	<i>Journal of the Warburg and Courtauld Institutes</i>
<i>MDAIK</i>	<i>Mitteilungen des Deutschen Archäologischen Instituts in Kairo</i>
<i>NT</i>	<i>Novum Testamentum</i>
<i>OSAPh</i>	<i>Oxford Studies in Ancient Philosophy</i>
<i>PAPhS</i>	<i>Proceedings of the American Philosophical Society</i>
<i>PSBA</i>	<i>Proceedings of the Society of Biblical Archaeology</i>
<i>REA</i>	<i>Revue des études anciennes</i>
<i>RhM</i>	<i>Rheinisches Museum für Philologie</i>
<i>RHR</i>	<i>Revue de l'histoire des religions</i>
<i>RPh</i>	<i>Revue de philologie, de littérature et d'histoire anciennes</i>
<i>SA</i>	<i>Sudhoffs Archiv</i>
<i>SAK</i>	<i>Studien zur Altägyptischen Kultur</i>
<i>TAPhA</i>	<i>Transactions of the American Philosophical Association</i>
<i>TAPS</i>	<i>Transactions of the American Philosophical Society</i>
<i>VRel</i>	<i>Visible Religion</i>
<i>ZAS</i>	<i>Zeitschrift für ägyptische Sprache und Altertumskunde</i>
<i>ZPE</i>	<i>Zeitschrift für Papyrologie und Epigraphik</i>

Text Conventions

Transliteration Conventions

For Greek transliteration, h = ῥ; e = ε; ē = η; th = θ; o = ο; ō = ω; x = ξ; ph = φ; ch = χ; ps = ψ.

For Egyptian transliteration, I follow the (slightly modified) convention of Gardiner, *Egyptian Grammar*, 3rd ed. Oxford: Oxford University Press, 1927, repr. 1969, §19.

For Hebrew transliteration, I follow the convention of *Dictionary of Deities and Demons in the Bible*, eds Karel van der Toorn, Bob Becking and P. W. van der Horst, 2nd rev. ed. Leiden/Boston/Grand Rapids, MI: Brill; Eerdmans, 1999.

Conventions for Editions and Translations

For texts in the original language, square brackets denote text to be deleted in the editor's opinion, and angle brackets denote additional text inserted by the editor. For texts in English translation, square brackets and Roman script denote words added by the translator, square brackets and italics denote editorial explanations by the translator, and angle brackets denote words translated from the editor's additions. All translations are mine unless otherwise noted.

In general, I use Latin names for ancient authors (e.g. Paulus Alexandrinus, Hephæstio, Rhetorius), except when an English version is in common use (e.g. Ptolemy).

For abbreviated works, refer to the Abbreviations above. Otherwise, I have given full bibliographical references on the first occasion a work is cited and in the bibliography. For subsequent citations, I have given only the author's last name and a short title. The exception is for critical editions of ancient works, in which the name of the editor will be given, with the full citation in the bibliography.

For astrological chart calculation, I have used Solar Fire 5.1. All figures and tables are my own unless otherwise noted.

Astrological Symbols

Sun	☉	Mars	♂
Moon	☾	Jupiter	♃
Mercury	☿	Saturn	♄
Venus	♀	Midheaven	MC
Hour-marker/ Ascendant	Asc	Lower Midheaven	IC
		Lot of Fortune	⊗

Lot of Daimon ☿ Note: *Siglum* after Laur. Plut. 28,34, fol. 141r (*GH*, pl. 32)

Lot of Basis	β
Aries	♈
Taurus	♉
Gemini	♊
Cancer	♋
Leo	♌
Virgo	♍
Libra	♎
Scorpio	♏
Sagittarius	♐
Capricorn	♑
Aquarius	♒
Pisces	♓

Introduction

Character for a human is his daimon

ἦθος ἀνθρώπῳι δαίμων

HERACLITUS¹

The word δαίμων has bedevilled many a scholar and translator of Greek texts. The deceptively simple phrase above is no exception. A mere three words in Greek, it has been variously translated as ‘Character is destiny’;² ‘A man’s character is his fate’;³ ‘Man’s character is his daimon’;⁴ ‘A man’s individuality is his *daimon*’ and ‘A man’s character is the immortal and potentially divine part of him’;⁵ ‘Seine Eigenart ist dem Menschen sein Dämon (*d.h. sein Geschick*)’;⁶ ‘Character for man is destiny’;⁷ ‘A man’s character is his guardian divinity’;⁸ ‘Habit for man, god’.⁹ I do not claim to have come up with the definitive rendering here,¹⁰ but the variations are striking.

1 Fr. B119, D-K, I, 177.

2 The earliest usage of this phrase that I have been able to find, possibly translating Heraclitus via the German poet and novelist Novalis (1772–1801), is in G. Eliot, *The Mill on the Floss*, Copyright Edition (Leipzig: B. Tauchnitz, 1860), VI, 6: “Character,” says Novalis, in one of his questionable aphorisms, “character is destiny.” J. Hillman, *The Soul’s Code: In Search of Character and Calling* (New York: Warner Books, 1996, repr. 1997), 211, 256–57, began this collection of translations; I borrow from him, and add.

3 J. Barnes, *Early Greek Philosophy* (London/New York: Penguin Books, 1987), 124; J. Burnet, *Early Greek Philosophy*, 4th ed. (Cleveland/New York: The World Publishing Company, 1930, repr. 1961), 141 (omits ‘A’).

4 G. S. Kirk, J. E. Raven, and M. Schofield, *The Presocratic Philosophers: A Critical History with a Selection of Texts*, 2nd ed. (Cambridge/New York: Cambridge University Press, 1983), 211.

5 Guthrie, *HGP* I, 482. The second translation, he explains, encompasses the belief in transmigration of souls and daimons which could advance to be more godlike.

6 D-K, I, 177.

7 K. Freeman, *Ancilla to the Pre-Socratic Philosophers* (Oxford: Basil Blackwell, 1948), 32.

8 P. Wheelwright, in *Heraclitus*, trans. P. Wheelwright (Princeton: Princeton University Press, 1959), 68.

9 A. Cook, ‘Heraclitus and the Conditions of Utterance’, *Arion* n.s. 2.4 (1975): 431–81; also ‘custom for man: god’, 472.

10 Not only is the translation of ‘daimon’ problematic, but ‘ethos’ also has multiple meanings. Guthrie, *HGP* I, 482 calls the phrase ‘scarcely translatable’. See the analysis of S. Darcus, “‘Daimon’ as a Force Shaping ‘Ethos’ in Heraclitus”, *Phoenix* 28, no. 4 (1974): 390–407.

These translations connect the daimon with character, fate, individuality and the divine. This is a rich, though intricate and tricky, amalgamation of ideas. These associations seem unique, but another subject takes up the same topics and incorporates them into its theory and practice. That subject is astrology.

1 Why the Daimon and Astrology?

The secondary literature on daimons and daimonology is vast. Merely considering the scholarship of the ancient western world yields work in Mesopotamian, Egyptian, Persian, Greek, Christian, Jewish, Hermetic, Gnostic, Pre- and Early-Islamic studies.¹¹ Daimonology has a solid presence in studies of Plato (especially Socrates' daimon), Plutarch, magic and religion.¹²

11 A representative sampling (certainly not complete) includes R. C. Thompson, *The Devils and Evil Spirits of Babylonia, being Babylonian and Assyrian Incantations against the Demons, Ghouls, Vampires, Hobgoblins, Ghosts, and Kindred Evil Spirits which Attack Mankind*, 2 vols., vol. 1, 'Evil Spirits' (London: Luzac and Co., 1903); M. J. Geller, *Evil Demons: Canonical Utukkū Lemnūtu Incantations* (Helsinki: Neo-Assyrian Text Corpus Project, 2007); C. E. Visser, *Götter und Kulte im ptolemäischen Alexandria* (Amsterdam: N. v. noord-hollandsche uitgevers-mij, 1938); J. Quaegebeur, *Le dieu égyptien Shai dans la religion et l'onomastique* (Leuven: Leuven University Press, 1975); P. Callieri, 'In the Land of the Magi. Demons and Magic in the Everyday Life of Pre-Islamic Iran', *Res Orientales* 13 (*Démons et merveilles d'Orient*) (2001): 11–35; G. Sfameni Gasparro, 'Daimôn and Tuchê in the Hellenistic Religious Experience', in *Conventional Values of the Hellenistic Greeks*, ed. Per Bilde, et al. (Aarhus: Aarhus University Press, 1997); S. R. L. Clark, 'Reason as Daimôn', in *The Person and the Human Mind: Issues in Ancient and Modern Philosophy*, ed. Christopher Gill (Oxford: Clarendon Press, 1990); S. Eitrem, 'Some Notes on the Demonology in the New Testament', *Symbolae Osloenses* Fasc. Supplet. XII (1950): 1–60; A. Y. Reed, *Fallen Angels and the History of Judaism and Christianity: The Reception of Enochic Literature* (Cambridge: Cambridge University Press, 2005); E. Iversen, *Egyptian and Hermetic Doctrine* (Copenhagen: Museum Tusulanum Press, 1984); A. J. Welburn, 'The Identity of the Archons in the "Apocryphon Johannis"', *VChr* 32, no. 4 (1978): 241–54; J. Henninger, 'Beliefs in Spirits among the Pre-Islamic Arabs', in *Magic and Divination in Early Islam*, ed. Emilie Savage-Smith (Aldershot: Ashgate Variorum, 2004).

12 A recent, comprehensive study of Platonic daimonology and its offshoots is A. Timotin, *La démonologie platonicienne* (Leiden/Boston: Brill, 2012). Other studies include H.-G. Nesselrath, ed., *Plutarch On the daimonion of Socrates: Human Liberation, Divine Guidance and Philosophy*, vol. XVI, *SAPERE* (Tübingen: Mohr Siebeck, 2010); F. E. Brenk, 'In the Light of the Moon: Demonology in the Early Imperial Period', in *ANRW*, vol. II, 16.3, ed. Wolfgang Haase (Berlin: De Gruyter, 1986) (see also Brenk's bibliography in *ANRW*); G. Sfameni Gasparro, 'Magie et démonologie dans les *Papyrus Graecae Magicae*', *Res Orientales* 13

Scholarship in ancient astrology is also robust, from the remarkable achievements of Franz Cumont, Franz Boll, Wilhelm Gundel and Auguste Bouché-Leclercq in the early twentieth-century, to the meticulous and thorough investigations of Otto Neugebauer, David Pingree, Erica Reiner, Wolfgang Hübner, Francesca Rochberg, Charles Burnett, Josèphe-Henriette Abry, Aurelio Pérez Jiménez, Giuseppe Bezza, Stephan Heilen, Alexander Jones, Joachim Quack and Alexandra von Lieven in the last fifty years.¹³ But virtually no secondary literature is devoted to investigating the daimon within astrology (when scholarship in astrology mentions both topics, it is incidental or tangential to the main purpose of the research). I know of no research focused on looking at the actual practice of astrology in relation to the daimon. Furthermore, most scholars of astrology have never practised it and, even if well-intentioned,¹⁴ often do not see, or are unable to appreciate, points of technique which have great bearing on the way astrology uses the daimon and on how this use creates and then affects its influence in other areas.

Analysing ancient astrologers' techniques, therefore, becomes an important investigative tool. Such analysis has uncovered scholarly gaps on the transmission of certain astrological practices, as well as important links from Mediterranean cultures (primarily Egyptian and Mesopotamian, but others as well) which illuminate the intention behind certain astrological practices and theory. I have discovered nuances in astrologers' views of astrology and fate which contradict the monolithic assumption that astrology and its practitioners are entirely fatalistic (such an assumption is usually taken by those opposed to astrology).¹⁵ Egyptian and Mesopotamian ideas of fate may influence astrological theory and practice. In examining the Neo-Platonist search for the personal daimon through the eyes of its Neo-Platonist astrologer, Porphyry, I make a case for astrology as theurgical practice by Porphyry (in addition to clarifying the murky classifications of 'house-masters' in astrology). Many of the astrological texts I use are under-researched, and it has been my joy to discover how

(*Démons et merveilles d'Orient*) (2001): 157–74; F. E. Brenk, *In Mist Apparelled: Religious Themes in Plutarch's Moralia and Lives* (Leiden: E.J. Brill, 1977); and S. I. Johnston and P. Struck, eds., *Mantikê. Studies in Ancient Divination*, vol. 155, Religions in the Graeco-Roman World (Leiden: Brill, 2005).

13 This author list is by no means complete. Rather than give only a partial list of this scholarship, I note the Warburg Institute's online database of the history of astrology at <http://warburg.sas.ac.uk/?id=470>, and the bibliography devoted to the topic of Greco-Roman astrology at http://webdeptos.uma.es/dep_griego/ASTROLOGIA.htm.

14 Many are not, especially those of the early 20th century, though current attitudes have changed, particularly in the last 15 years.

15 Here both ancient and modern critics are included.

much they augment not only our understanding of the techniques of astrology, but also its highly complex and sophisticated theoretical underpinnings.

Examining the intersections of the daimon with astrology enhances our knowledge from two directions: how the daimon is used within astrology, and how astrology is used in practices involving the daimon. It further broadens the ways in which fate was understood and incorporated into the cultural practices of the Graeco-Roman era and Late Antiquity.

2 The Multivalent δαίμων

2.1 Usage and Spelling

It is important at the outset to explain the usage of the word ‘daimon’ in this book. Although the concept of the daimon itself includes a number of meanings, and translation can be varied, I generally prefer the spelling ‘daimon’ (not italicised).¹⁶ Its various connotations will not require a different spelling: meaning will be elucidated by qualifiers and explanation. There are two exceptions to this policy. Because of its widely understood connotation in English, for a bad or evil daimon I may use ‘demon’ without a qualifier. To avoid ambiguity and when otherwise appropriate, I retain the word δαίμων in Greek script, or *daemon* in a Latin context.

2.2 Understanding ‘Daimon’

The concept of the daimon is multivalent and mutable in all Mediterranean cultures. Mesopotamian and Egyptian cultures do not necessarily differentiate between ‘god’ and ‘daimon’ as understood in the West. Both contain the equivalent of what is often described by scholars as a genie or a demon, depending on its positive or negative functions and relative strength in comparison to ‘gods’. But there is often no distinction between a ‘god’ and a ‘daimon’: both can be called by the name ‘god’. Thus, equivalence with the parameters of a Greek δαίμων must not be assumed; even though there may be similarities in functions, each culture has its own idiosyncrasies for these beings.

Even in Greece, the daimon cannot be contained within strict functional constructs. From Homer onward, the daimon’s multivalence has led to a myriad of translations to explain it in context: demon, spirit, genius, personality, destiny, power, even fate. Defining the daimon has always been difficult,

16 Often ‘daimon’ and ‘daimones’ are italicised as transliterated Greek words in the scholarship of Classics, Philosophy and Religion. I prefer ‘daimon’ and ‘daimons’, partly to normalise this spelling in English and partly because of aesthetics in the book.

though today's connotation of a 'demon' only as an evil spirit has replaced earlier, less rigid, ones. In Homer, Elisabeth Brunius-Nilsson has shown that, far from having an automatic negative connotation, δαίμων can be considered to be both a divine force¹⁷ and to have an ambivalent, neutral sense which can only be understood as good or evil in context.¹⁸ Hesiod's daimons, the souls of departed Golden and Silver Age mortals, were purely good.¹⁹ Other daimons were malevolent.²⁰ Popular culture always took account of local spirits, either good or bad, and made sure to propitiate them; and spirits (called daimons or other names) have long been connected with illness, madness and death. From Plato two enduring ideas—first, that daimons are mediators between gods and humans; and second, that everyone has a personal daimon guiding them through life—took root and spread through the culture of the Mediterranean from the Hellenistic period to Late Antiquity.

This brief preliminary description of 'daimon' serves to introduce the various modes of daimon in Mediterranean cultures which will be explored in their relationship to astrology in this work. More elaborate treatment will arise organically within each chapter.

3 Astrology and the Daimon

The area and time in which western astrology arose was the Mediterranean basin in, roughly, the second half of the first millennium BCE. This milieu contained the cultures which contributed to astrological practices: primarily Babylonian, Egyptian and Greek, with some Persian influences. By the close of the millennium Greek had become an important vector language for astrological texts, although the concepts and practices used in astrology often drew from other cultures.²¹ Thus, though I use the term 'Hellenistic astrology' in this

17 E. Brunius-Nilsson, *Daimonie, an inquiry into a mode of apostrophe in old Greek literature* (Uppsala: Almqvist & Wiksells, 1955), 123: 'an actively intervening power or force'.

18 *Ibid.*, 132–33.

19 Hesiod, *Works and Days*, 121–126; at 252–255 he does not use the word daimon. See F. E. Brenk, 'Genuine Greek Demons, "In Mist Apparell'd"? Hesiod and Plutarch', in *Relighting the Souls: Studies in Plutarch, in Greek Literature, Religion and Philosophy, and in the New Testament Background*, ed. Frederick E. Brenk (Stuttgart: F. Steiner, 1998).

20 See E. R. Dodds, *The Greeks and the Irrational* (Berkeley/Los Angeles/London: University of California Press, 1951), 39–42.

21 See e.g., D. Pingree, *From Astral Omens to Astrology: From Babylon to Bikāner* (Rome: Istituto italiano per l'Africa e l'Oriente, 1997), 21–29; F. Rochberg-Halton, 'Elements of the Babylonian Contribution to Hellenistic Astrology', *JAOs* 108, no. 1 (1988): 51–62;

book to mean the astrology of the Mediterranean from the Hellenistic period to Late Antiquity, the subject itself encompasses more than the influence of Greece.

This book's main purpose is to explore the concept of the daimon as it is used within the theory and practice of Hellenistic astrology. Hellenistic astrology was not immune to multiple conceptions of the daimonic, not only from Greek, but also from Babylonian, Egyptian and other cultures, and from religious and magical practices. One might assume that, as a practice, astrology would be primarily concerned with explaining or predicting the effects of bad daimons. This is partially true, but good daimons were equally important, and so was the idea of a personal daimon both discernible in the chart and even, for some, responsible for the particular arrangement of heavenly bodies and relevant points within the chart.²² Furthermore, the daimon is entwined not only with the practice, but with the theory and philosophy behind Hellenistic astrology. Astrology, in fact, is highly dependent on religious and philosophical conceptions of the daimon. This can be seen in a number of different areas which we will now briefly introduce.

3.1 *Daimon in the Astrological Places*

The astrological chart is drawn up, and its data discovered, for a particular moment in time, but its fundamental layout is fixed. The chart is divided into twelve sections (called τόποι, 'places'), each correlated with an area of life. Two of the sections are named 'Good Daimon' and 'Bad Daimon'; thus one-sixth of the chart represents the daimon and what is attributed to it. Furthermore, and importantly, the places opposite to these are called 'Good Fortune' and 'Bad Fortune'. This is not accidental. As we shall repeatedly see in this book, Daimon and Fortune (Tyche) are often culturally, religiously and philosophically paired.²³ Indeed, they often cannot be separated.

D. G. Greenbaum and M. T. Ross, 'The Role of Egypt in the Development of the Horoscope', in *Egypt in Transition: Social and Religious Development of Egypt in the First Millennium BCE*, ed. Ladislav Bareš, Filip Coppens, and Kveta Smolarikova (Prague: Faculty of Arts, Charles University in Prague, 2010).

²² See Chapter 7.

²³ See R. Ganschinietz, 'Agathodaimon [1]', in *RE*, Suppl. Bd. III (Stuttgart: J. B. Metzler, 1918), cols. 37–59, here cols. 42–43.

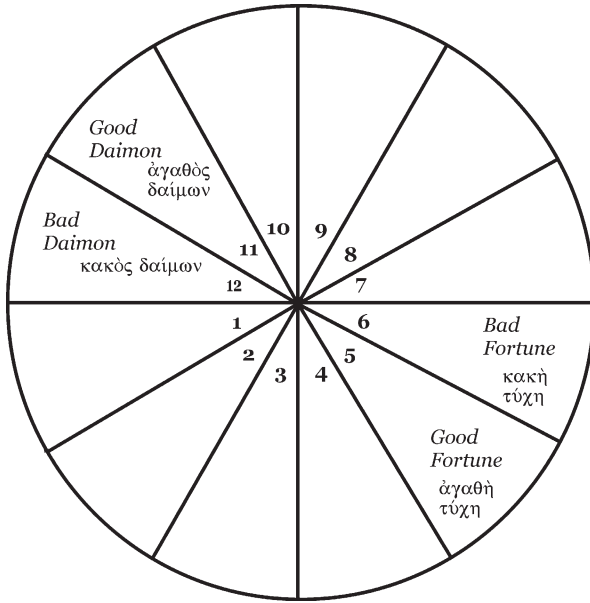

FIGURE 1.1 *The Daimon and Fortune places in the astrological chart.*

3.2 *Daimon and Astrological Lots*

In addition to these places giving astrologers a constant reminder of the daimon whenever they looked at a chart, the daimon appears in the astrological interpretive technique called ‘lots’. Lots are specific points in the chart, found by taking the arc between two planets (or a planet and another point) and projecting it from a third point.²⁴ (For further explanation, and a primer on Hellenistic astrological technique, see Appendix 1.A, Basic Astrological Techniques.) The two most important lots are the Lot of Fortune (τύχη) and the Lot of Daimon (δαίμων).²⁵ These two lots are linked to each other by the way they are formed—projecting the arc between the Sun and Moon from the Ascendant (the degree rising on the eastern horizon at the time of birth), but in reverse order; thus they are mirror images of each other. The Lots of Fortune and Daimon are not seen as producing, or signifying, either solely

24 Lots are known by a misnomer in modern astrology as ‘Arabic’ parts—translating the Latin *pars*—though they have a prominent role in Hellenistic astrology.

25 Fortune is ‘the archetypal lot’: Vettius Valens, *Anthology*, II, 13.1 (Pingree, 65.5):... τὸν ἀρχέτυπον κλήρον... Daimon is the ‘second lot’: Valens, II, 15.9 (Pingree, 66.30–31):... τοῦ δευτέρου κλήρου (ὅς προσαγορεύεται δαίμων)...

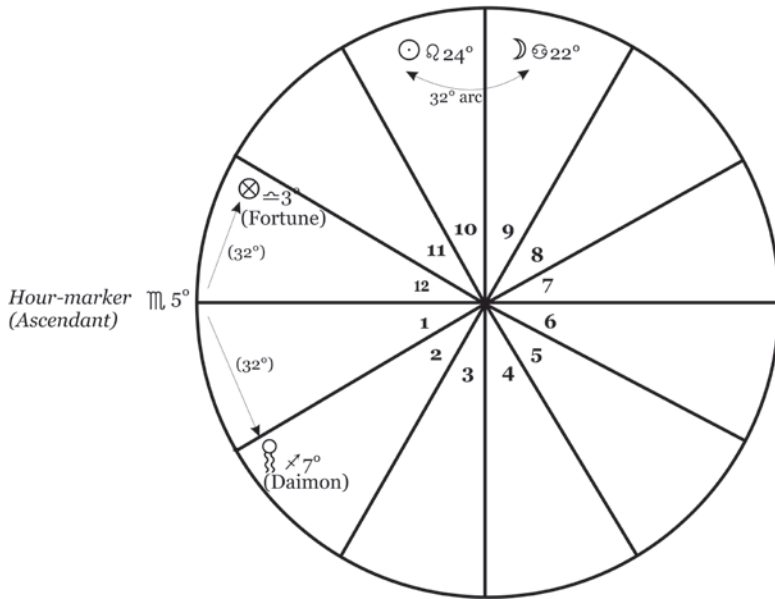

FIGURE 1.2 *The Lots of Fortune and Daimon in a chart.*

good or bad outcomes,²⁶ but they represent things important to a good life. Fortune signifies the body, physical well-being and literal fortune, the acquisition of goods; Daimon the soul, character and reputation;²⁷ but sometimes the two lots could even have the same meanings.²⁸ The Lot of Fortune is the Moon's lot, and the Lot of Daimon the Sun's.²⁹

26 Whether they predict good or bad outcomes is dependent on where they are placed, their rulers and their aspects. (The issue of cause versus sign will not be discussed here.)

27 See Paulus Alexandrinus, *Introduction*, ch. 23; Olympiodorus, *Commentary on Paulus*, ch. 22; Antiochus of Athens/Rhetorius (copying Paulus), *Thesaurus* 47; Valens, II, 21.

28 Antiochus/Rhetorius (Paulus), *Thesaurus* 47, CCAG I, 160.12–16: Σελήνης ὁ κλήρος τῆς τύχης σημαίνει πάντα τὰ ἐπὶ τοῦ σώματος τῶν ἀνθρώπων καὶ τὰς κατὰ τὸν βίον πράξεις καὶ δόξας καὶ τὰ τῆς ψυχῆς πάθη καὶ τὰς συμβιώσεις. Ἡλίου ὁ κλήρος τοῦ δαίμονος σημαίνει τὰ περὶ τῆς ψυχῆς καὶ τρόπου καὶ δυναστείας καὶ ἀξίας καὶ δόξης καὶ θρησκείας. ('The Moon's Lot—the Lot of Fortune—signifies all things in human bodies and the actions in life, reputations, sufferings of the soul and companionship. The Sun's Lot—the Lot of Daimon—signifies things concerning the soul, character, power, worth, reputation and religious rites.') It is fairly typical in astrology that opposing pairs can have similar meanings.

29 Ibid.

Many Hellenistic astrologers who write in detail about lots mention both the Lot of Fortune and the Lot of Daimon.³⁰ The lots are used in calculating length of life, in predicting happiness (*eudaimonia*, literally having a good daimon) and in predicting the good and bad periods of a life.³¹ As the second-century astrologer Vettius Valens explains, ‘One must cast out from [*i.e.*, use as a prediction point] the Lots of Fortune, Daimon, Eros and Necessity,³² for the experiences aligned to the times—both the good activities and the dangers—will be taken over from these.’³³

3.3 *Astrology and the Personal Daimon*

Astrology is also utilised in the search for identifying a personal daimon. In sources as disparate as the Magical Papyri and Neo-Platonic writings, the personal daimon is an important topic of discussion. Spells in the Magical Papyri give instructions for finding a personal daimon, linked to the petitioner’s own astrological configuration (PGM XIII.708–14); invocations are made to a ‘Good Daimon’ who is represented by the Sun (PGM VII.505–528); and entreaties are composed to the Good Daimon where a pre-ordained fate can seemingly be changed by changing the astrological data (PGM XIII.608–614, 633–637, 708–714). For Neo-Platonists such as Plotinus,³⁴ Iamblichus³⁵ and Porphyry,³⁶ the personal daimon plays a part in the struggle to help the soul ascend to the divine. Astrology becomes controversial in this attempt, embroiled as it is in concerns with fate, freedom and the ability to transcend the material world.

3.4 *Astrology, the Daimon and Fate*

The well-known relationship between daimons and fate is at times closely connected with astrology and the courses of the stars. In his essay *What is Up to Us*, Porphyry explains how the daimon synchronises with particular astral configurations at the moment of birth. In the *Hermetica*, daimons also link

30 Including Dorotheus, Valens, Antiochus, Paulus, Hephaestio, Firmicus Maternus, Olympiodorus and Rhetorius.

31 Most astrologers deal with length of life, including Ptolemy, Valens, Dorotheus, Paulus and Hephaestio; Valens deals with happiness in II, 17–18, 20–22; and good and bad periods in IV, 4–10; II, 25.

32 Two other lots related to Fortune and Daimon; see Chapter 10.

33 Valens IV, 11.32 (Pingree, 165.25–7): και ἀπὸ τοῦ κλήρου τῆς τύχης δεῖ ἐκβάλλειν και ἀπὸ τοῦ δαίμονος και ἔρωτος και ἀνάγκης· ἐκ τούτων γάρ και τὰ καιρικά πάθη και αἱ εὐεργεσίαι και οἱ κίνδυνοι παραλαμβάνονται.

34 *Enneads* II, 3; III, 4.

35 *De mysteriis* IX.1–3, 5–10.

36 *Letter to Anebo* 2, 14–17 (Sodano).

with the stars. The regular movements of the planets and stars in heaven are used as indicators of time, a time that is thus bound to and indicative of the material world of generation and corruption. The stars are seen as gods or daimonic beings who oversee the fate thereby engendered. As administrators and overseers of time and fate, they hark back to the Egyptian decans, thirty-six star groups that rise at consecutive ten-day intervals and regulate not only the passage of time but the behaviour of humans. Decans also appear in astrology.

Astrology has long been associated with human fate as well, often in terms which assume the principles of Greek fate, often a hard determinism (I use the phrase of modern scholarship here) or even fatalism, although some recent scholarship discusses its compatibility with soft determinism based particularly on Stoic ideas.³⁷ Though I am leery of applying anachronistic terminology too freely, certainly it is important to differentiate among various kinds of fate. Most scholarship considering fate and astrology has heretofore concentrated primarily on the relationship of Greek concepts of fate to astrology,³⁸ but I shall also explore the important connections of Egyptian and Mesopotamian fate to Hellenistic astrology in this book. In many cases these versions of fate conform better to what is actually happening in the practice of astrology in the Mediterranean *oikoumenē*.

Astrology is linked to the bad daimon in the tenets of early Judaism and Christianity, held to be the creation of evil daimons who desire to deceive and corrupt mankind.³⁹ Such entanglement plays a role in the demonisation of the daimon which rose to become the dominant paradigm by the Middle Ages. Still, the daimon has undergone periods of rehabilitation, e.g. in the Renaissance by Marsilio Ficino⁴⁰ and in the twentieth century by Carl Jung⁴¹ and James Hillman.⁴²

37 A. A. Long uses the terms 'hard' and 'soft' astrology: see A. A. Long, 'Astrology: arguments pro and contra', in *Science and Speculation: Studies in Hellenistic theory and practice*, ed. Jonathan Barnes, et al. (Cambridge: Cambridge University Press, 1982); R. J. Hankinson speaks of 'strong' and 'weak' astrology: R. J. Hankinson, 'Stoicism, Science and Divination', *Apeiron* 21, no. 2 (1988): 123–60, esp. 129–35; also idem, *Cause and Explanation in Ancient Greek Thought* (Oxford: Clarendon Press, 1998), 290–92. For a view more knowledgeable about the practice of astrology, see D. Lehoux, 'Tomorrow's News Today: Astrology, Fate and the Way Out', *Representations* 95 (2006): 105–22.

38 E.g., D. Amand, *Fatalisme et liberté dans l'antiquité grecque* (Louvain: Bibliothèque de l'Université, 1945, repr. Amsterdam: Adolf M. Hakkert, 1973).

39 I shall deal with this topic in a forthcoming article.

40 *De vita*, 3 (*Liber de vita coelitus comparanda*).

41 See especially his *Memories, Dreams, Reflections*, trans. Richard and Clara Winston (New York: Vintage Books, 1961, repr. 1989).

42 Hillman, *Soul's Code*.

4 The Plan of the Book

My method of organisation in this book is to look at the topic of the daimon in astrology as a multi-layered circle. Thus I approach it first from a general, introductory viewpoint which supplies broad definitions and historical context. These outer layers set the stage and provide a foundation of knowledge, while inner layers provide more detailed and specialised work as the book progresses. I shall, therefore, revisit various topics to explore them in more depth. Concepts only outlined in one part of the book will be fleshed out in greater detail and complexity in another.

The work covers several broad areas: daimon and its relationship to fortune, its relationship to gods, and its relationship to lots. Accordingly, the book will be divided into three parts: 1) *Daimon and Fortune*, 2) *Gods and Daimons*, and 3) *Lots and the Daimon*. Each of the ten chapters will fall into one of these areas. Under these broad areas, different topics will be addressed within the main theme of each chapter, which allows me to examine how the daimon is incorporated within astrology's theory and practice correlated with the wider cultural milieu.

4.1 *The Contents of the Chapters*

In Part 1, *Daimon and Fortune*, Chapter One will introduce the topics of daimon, fortune and astrology through two representative authors from the second century CE: Plutarch (for the daimon) and Vettius Valens (for astrology). Not coincidentally, the second century is a crucial time both for concepts of daimon and for the theory and practice of astrology. Each of these writers has much to convey about the ways in which daimon and astrology permeate the culture, and the ways in which they interact with each other. This study of Plutarch and Valens highlights the major theme of fate and free will linked to astrology and daimons which continues throughout the book. We shall also get a first taste of what it means to have a personal daimon.

Chapters Two and Three take up the astrological places of Good Daimon and Good Fortune, along with discussing these concepts culturally. In Chapter Four, the same treatment is given to the places of Bad Fortune and Bad Daimon.

Chapter Two introduces the cultural pair of Tyche and Daimon, and considers the good daimon in astrological and cultural manifestations. The astrological Good Daimon is the eleventh place in the chart, and its partner in the fifth is Good Fortune. I investigate what the major Hellenistic astrologers say about these places in theory and in practice. In Chapter Three, I turn to the influence of Egypt on the Agathos Daimon as it travels from Greece to Egypt and becomes syncretised to an Egyptian divinity, Shai. Considered also is the counterpart of the Agathos Daimon, Agathe Tyche, which has Egyptian

equivalents with an impact on astrology. Mesopotamian conceptions of fate and equivalents of good daimons are discussed in relationship to Egyptian and Greek ideas. These topics lead to a consideration of fate and its perception within and outside of astrology.

In Chapter Four the bad daimon and its places are investigated. An overview of bad daimons in the Mesopotamian, Egyptian, Greek, Jewish and Christian traditions gives a backdrop for the context in which I discuss astrologers' views of the bad daimon, and what impact the cultural conceptions of bad daimons may have had on this part of astrological theory and practice. This chapter includes a study of the sixth and twelfth astrological places, Bad Fortune and Bad Daimon.

Part 2, *Gods and Daimons*, looks at astrology and the daimon through the lens of the similarities, differences and fluidity between gods and daimons. Chapter Five approaches this from the religious perspectives mainly of Gnosticism and Mithraism; and Chapter Six from examining Hermetic and magical texts, and lore on the decans. Ambivalence is a theme in these chapters. The daimons considered here can either help or hinder humans, especially in magical and religious practices, and can be perceived as both good and evil. Ambivalence also covers the role of daimons who are on the margins of the line between god and daimon, who may cross that line or whose status is fluid.

Chapter Seven, the final chapter in Part 2, is devoted to the personal daimon and astrology, again dealing with the god/daimon divide. Here the focus is on Porphyry,⁴³ but around him hover the figures of Plotinus, Iamblichus and all the astrologers who discuss the topic of the *oikodespotēs*, the 'house-master' associated by Porphyry with the personal daimon. Porphyry's interest both in daimons and astrology makes him a perfect candidate for an extensive case study. Within this chapter I also investigate how other astrologers defined and used the *oikodespotēs* compared to the way Porphyry uses it.

Part 3, *Lots and the Daimon*, covers the critical relationship among lots, the daimon and astrology. Chapter Eight introduces the daimon and the lot, beginning from the vantage point of Plato's Myth of Er. It also introduces the general concept of lots in astrology, and investigates the way they are utilised in astrological theory and practice. Here will be found the influence of other divinatory practices on astrology, reflecting its own origins in divination. Chapters Nine and Ten are extended studies of four important astrological lots: Fortune

43 As this book was about to go to press, I came across A. P. Johnson, *Religion and Identity in Porphyry of Tyre: The Limits of Hellenism in Late Antiquity* (Cambridge: Cambridge University Press, 2013). I have not had time to give this book the attention it deserves, though I shall cite it at a few points.

and Daimon, and Eros and Necessity (we shall see how and why these lots are linked, and what the daimon has to do with this). I explore their heritage in religion and philosophy as well as their importance in astrological practice. In these chapters case studies of individual charts, as analysed by Hellenistic astrologers, are indispensable in explaining how lots work and how they are used.

Throughout the book, in fact, case studies from historical astrological practice inform my conclusions and increase our understanding of the relationship between the daimon and astrology. The categories described here cannot always be strictly differentiated, and there will sometimes be overlap between topics and themes from chapter to chapter. Though I often distinguish between 'cultural' practices and 'astrological' ones, this is a purely convenient way to examine a large amount of material. In no way is it my position that 'culture' and 'astrology' are or should be separated. In fact, I consider astrology to be an integral component of culture in the period under investigation. To that end, I hope this book will shine a light on the importance of both astrology and the daimon in the ancient Mediterranean world.

PART 1

Daimon and Fortune



Kindled Spirits: The Daimon, Plutarch and Vettius Valens

... those possessed by some special, daimonic ... luminosity.

PLUTARCH, *De genio Socratis*, 589c3–4¹

The daimon played an important cultural role in the Greco-Roman world. In the second century, particularly, there was a widening interest in daimons and their place in the cosmic hierarchy as well as on earth. As intermediaries between gods and humans, as well as in their capacity as personal guides, daimons interacted with humans on several different levels.

Astrology, too, was in a stage of fruitful development in the second century (this is the century of Ptolemy, Vettius Valens and [probably] Antiochus of Athens). It was accepted and acceptable (not by everyone, of course) not only at the popular level, but also at a more sophisticated intellectual and philosophical level, incorporating ideas of Plato and the Academy, the Pythagoreans, the Stoics, the Aristotelians and the Hermetists.

Because the second century is so rich in material on both the daimon and astrology, it is a fitting place to launch our investigation. The way in will be through the work of two important figures of this period, Plutarch of Chaeronea (ca. 46–ca. 120) and Vettius Valens of Antioch (b. 120, fl. 145–170).² I have chosen

¹ ... οἷς ἔπεστιν ἰδίον τι καὶ δαιμόνιον ... φέγγος. (Sieveking).

² The secondary literature on Plutarch is massive; see the bibliographies in F. E. Brenk, *In Mist Apparelled*; idem, 'In the Light of the Moon: Demonology', 2068–2145 for a partial list (pertaining to his daimonology). For Valens, obviously, there is not as much; but he is mentioned in most histories of astrology. Boll calls him 'streitbare ... ein plebejischer Mann von mäßigem Verstande': F. Boll, C. Bezold, and W. Gundel, *Stern Glaube und Sterndeutung: Die Geschichte und das Wesen der Astrologie*, 3rd ed. (Leipzig/Berlin: B. G. Teubner, 1926), 28. Arthur Nock calls him 'an author of so much importance not only for astrology proper but also for "mysticisme astral" and religious feeling...'. (Nock's editorial comment in O. Neugebauer, 'The Chronology of Vettius Valens' *Anthologiae*, *HThR* 47, no. 1 (1954): 65–67, here 65, n. 1). Four translations of Valens, 3 published and 1 unpublished but online, exist: Vettius Valens, *Anthologies. Livre I*, trans. J.-F. Bara (Leiden: E. J. Brill, 1989); Vettius Valens, *The Anthology, Books I–VII*, trans. Robert Schmidt, 6 vols. (Berkeley Springs, WV/Cumberland, MD: Golden Hind Press, 1993–2001); Vettius Valens, *Blütensträuße*, trans. Otto Schönberger and Eberhard Knobloch (St. Katharinen: Scripta Mercaturae, 2004); M. Riley, 'Draft translation of

Plutarch, first, because he was a prolific and learned essayist whose popularity and influence persisted throughout the second century (and beyond). His writings transmitted and amplified the cultural and philosophical zeitgeist. Most importantly, a number of his essays dealt with various concepts and permutations of the daimon. The astrologer Vettius Valens was born at about the time that Plutarch died. His work as a practising astrologer with some knowledge of his day's philosophical trends makes him a fitting candidate for this introduction. In addition, though Plutarch and Valens cannot be linked directly, circumstantial evidence shows that topics represented in the Chaeronean's work were relevant to Valens' interests, and will be explored below.

Valens' nine books of astrology, the *Anthologiae*, give both a comprehensive view of second century astrology and the philosophical and religious inclinations of their author. We are similarly enlightened on Plutarch's religious and philosophical views (he was a priest at Delphi as well as a Platonist philosopher) by his *Moralia* which, fortunately for our purposes, provide a fascinating portrait of his daimonology. Plutarch's work on this topic presents multiple concepts of the daimon as understood in the Greco-Roman period.³ Though our introduction can necessarily be no more than a brief encounter with Plutarch's daimons, it will help in seeing how his views may reflect the use of the daimon in astrology; and how the philosophy of astrology may parallel, or coincide with, or anticipate these views. From this perspective we shall discover what astrology and astrologers can contribute about the daimon and its

Vettius Valens, *Anthologiae*, Books 1–1X, Unpublished Work at <http://www.csus.edu/indiv/r/rileymt/Vettius%20Valens%20entire.pdf> (accessed 15 April 2015). Joanna Komorowska has written extensively on Valens' intellectual life: see her *Vettius Valens of Antioch: An Intellectual Monography* (Kraków: Księgarnia Akademicka, 2004); also eadem, 'Philosophical Foundation of Vettius Valens' Astrological Creed', *Eos* 83 (1995): 331–35. See also M. Riley, 'Theoretical and Practical Astrology: Ptolemy and his Colleagues', *TAPhA* 117 (1987): 235–56; and idem, 'A Survey of Vettius Valens', Electronic Article (1996), http://www.csus.edu/indiv/r/rileymt/PDF_folder/VettiusValens.PDF, originally written for *ANRW* 11, 36.7, never published but now online (accessed 15 April 2015). See also: E. Boer, 'Vettius Valens', in *RE*, *Zweite Reihe*, vol. VIII.2 (Stuttgart: Metzler, 1958), cols 1871–73, (no. 67); W. Hübner, 'Vettius Valens', in *DNP*, Band XII/2 (Stuttgart: Metzler, 2002), cols 150–51; also W. Gundel and H. G. Gundel, *Astrologumena. Die astrologische Literatur in der Antike und ihre Geschichte* (Wiesbaden: Steiner, 1966), 216–21. Not all are as kind as Boll and Nock.

3 For a discussion of these concepts in various Middle Platonic authors, see Timotin, *Démonologie*, 164–214, 244–86. For the concepts of daimon in Plutarch and Apuleius (regarding the *daimonion* of Socrates), see J. F. Finamore, 'Plutarch and Apuleius on Socrates' Daimonion', in *The Neoplatonic Socrates*, ed. Danielle A. Layne and Harold Tarrant (Philadelphia: University of Pennsylvania Press, 2014), here 38–41, 44–49.

conception in the second century. In addition, connections with the concept of fate and the daimon's intersection with it, on the parts of both Plutarch and Valens, will surface during this examination. Fate and the daimon in connection to Hellenistic astrology will become a recurring theme in this book.

1 Plutarch and the Daimon

1.1 *Fear of the Daimon*

Plutarch's daimonology is transmitted in several of his *Moralia*, and daimons also appear in some of his *Parallel Lives*.⁴ In an early work, *On Superstition* (Περὶ δεισιδαιμονίας),⁵ Plutarch explains the superstitious man as one who over-reacts to bad events in his life, blaming his impiety and being hated by both gods and daimons (168c10–11).⁶ That Plutarch himself believed in a personal guiding daimon such as Plato describes,⁷ there is no doubt; like many others, though, he also acknowledged the presence of evil daimons who could sway people into less than virtuous behaviour. Δεισιδαιμονία is, literally, fear of the daimon.⁸ The superstitious man, with too much fear, or misplaced fear, of the divine (or divine retribution?) may translate his fear into what are seen as evil promptings by daimons or gods. Perhaps his fear interferes with his ability to make correct choices, to the point of acting badly or superstitiously from fear. In contrast to the negativity of δεισιδαιμονία the Greek word

4 Some essays in the *Moralia* which mention daimons are *On Superstition*, *On Isis and Osiris*, *On the Delays of Divine Vengeance*, *On the Sign of Socrates*, *On the Face in the Orb of the Moon* and *On the Obsolescence of Oracles*. *Lives* which mention daimons include *Pelopidas*, *Dion*, *Brutus*, *Cato the younger*, *Alexander*, *Sulla*, *Pompey*, *Crassus*, *Timoleon*, *Antony* and *Philopoimen*. For *daimōn* (as well as *tuchē*) in the *Lives* and the *Moralia*, see Brenk, *In Mist Apparelled*, ch. 8.

5 See Plutarch, *De superstitione*, trans. Frank Cole Babbitt, in *Moralia*, II (Cambridge, MA: Harvard University Press, 1928, repr. 2002). It is generally agreed that *On Superstition* is an early work. See K. Ziegler, 'Plutarchos, II 3, Chronologie', in *RE*, Zweite Reihe, Band XXI.1 (Stuttgart: Metzler, 1951), cols 708–719; C. P. Jones, 'Toward a Chronology of Plutarch's Works', *JRS* 56, Parts 1 and 2 (1966): 61–74; Brenk, *In Mist Apparelled*, 14, 49 (at 52–64, Brenk has suggested some of my trains of thought in this section).

6 Plutarch, *De superstitione* (trans. Babbitt) in *Moralia*, II, 474:.. τὸν ἀσεβῆ, τὸν ἐπάρατον, τὸν θεοῖς καὶ δαίμοσι μεμισημένον.

7 *Apology* 31d, 40a–c; *Timaeus* 90c; *Theages* 128d–e, 129; and particularly in Book x of the *Republic*, the Myth of Er, 619e, 620d–e. There are important parallels between Er and Plutarch's myth of Timarchus in *De genio Socratis* (see below).

8 Brenk, *In Mist Apparelled*, 53, has also pointed out this literal meaning.

for ‘happiness’ is εὐδαιμονία, literally ‘having a good daimon’.⁹ Either way—for good or bad—the power of the daimon is vast in the human mind of this time.

1.2 *The Abandonment of Oracles*

The tenets of Plutarch’s daimonology are laid out in *De defectu oraculorum* (Περὶ τῶν ἐκλελοιπότεων χρηστηρίων).¹⁰ A character in the essay, Cleombrotus, gives a history of the daimon from Homer and Hesiod to Plutarch’s time. Daimons are mediators between gods and humans¹¹ and as such they, not gods, inhabit the oracles. The daimon of the oracle is like the Platonic conception of the daimon, i.e. between divine and mortal. Oracles are part of nature, manifested in matter (ἕλη) and therefore not immortal, and so can decline and pass away. The gods themselves do not go into the bodies of the prophets and use them as instruments (414d–e)—for this was created the ‘race of daimons’ (τὸ τῶν δαιμόνων γένος) (415a), who are ‘ministers of the gods’ and ‘overseers of the sacred rites of the gods and prompters in the Mysteries’ (417a).¹² As intermediaries, daimons can mediate between the divine and immortal and the human and mortal, can interpret between gods and humans (and it is a two-way street, both from gods to humans and from humans to gods). With their ‘interpretive and ministering nature’,¹³ and as divinatory messengers, daimons provide ways

-
- 9 Dodds, *Greeks and the Irrational*, 42, claims that *eudaimōn* first appears in Hesiod; *kakodaimōn* and *dusdaimōn* do not appear until the 5th century BCE. *Deisidaimon-*, according to the *TLG*, first appears in Aeschylus. See also W. C. Greene, *Moirā: Fate, Good and Evil in Greek Thought* (New York/Evanston: Harper and Row, 1944, repr. 1963), 324–25: the importance of *eudaimonia*, Greene reminds us, is taken up by Aristotle, in both his *Nicomachean Ethics* (1097a–b) and, with a possible source in daimonic favour, in his *Eudemian Ethics* (1214a).
- 10 This is not the place for further analysis, but note that the word Plutarch uses for the ‘abandonment’ or ‘decline’ of the oracles derives from the same verb, ἐκλείπω, whose astronomical meaning is ‘eclipse’.
- 11 On this topic see Timotin, *Démonologie*, Ch. 3, esp. 37–46, 74–84, who weaves a coherent structure of intermediation, applied especially to the daimon, among Plato’s dialogues.
- 12 Plutarch, *De defectu oraculorum*, trans. Frank Cole Babbitt, in *Moralia*, v (Cambridge, MA: Harvard University Press, 1936, repr. 2003), 417a8–11: . . . λειτουργοῖς θεῶν . . . δαίμονας νομίζωμεν ἐπισκόπους θεῶν ἱερῶν καὶ μυστηρίων ὀργιαστάς. . . . Daimons are called *leitourgoi* in Hermetic and Gnostic texts, and associated with decans. See Chapter 6.
- 13 416f: τὴν ἐρμηνευτικὴν . . . καὶ διακονικὴν . . . φύσιν. Plato’s words (*Symposium* 202e [Burnet, vol. 2]) are slightly different: the daimon possesses the power of ἐρμηνεῖον καὶ διαπορθεῖον, ‘interpreting and transporting’ human things to gods and divine things to humans. English translations from *De defectu oraculorum* adapted from Frank Cole Babbitt’s in *Moralia*, v, 379, 389.

for men to know the will of the gods. Furthermore, without daimons the order of the cosmos would be disrupted (416f).¹⁴

Daimons are particularly linked with the moon in Plutarch's schemes (see *De defectu* 416e, *De facie* 944c and *De genio Socratis* 591b–c). The gods are like the sun and stars, but the daimon is like the moon, halfway between the earth and the heavens. If the sun corresponds to a god, then the moon, as an intermediary, transmits this solar divine light to the earth/mortals. We cannot look at the sun directly for more than an instant for fear of going blind, but we can easily look at the light of the moon. Parallels in astrological literature reflect these views. The astrological Moon also ministers, 'being nearer to the earth, receiving the effluences of the stars above her and ministering (διακονούσα)¹⁵ to the places surrounding the earth, she rules over the entire human body.'¹⁶ In Vettius Valens, the astrological Sun signifies 'kingship, leadership . . . judgement . . . popular authority . . . master . . .',¹⁷ The ninth place is that of the Sun God, the third that of the Moon Goddess.

1.3 Socrates' Daimon

Another important essay for Plutarch's daimonology is *De genio Socratis* (Περὶ τοῦ Σωκράτους δαιμονίου), often translated as *On the Sign of Socrates*.¹⁸ (The

14 Ibid., 388–89: . . . οἱ δαιμόνων γένος μὴ ἀπολείποντες . . . πάντα φύρειν ἅμα καὶ ταράττειν ἀναγκάζουσιν ἡμᾶς . . . ' . . . those who refuse to leave us the race of daimons . . . force us to a disorderly confusion of all things . . . ' (Trans. Babbitt, slightly modified.) This may show a connection between daimons, time and the creation of order (see below, 3.5, 44), or just that daimons are essential to cosmic order. *Timaeus* 37d describes the *chronos* that came into being when cosmos arose from chaos, but Cleombrotus's statement seems to imply that without the mediating presence of daimons disorder would arise again. In *Platonic Questions* 1007c–e and *The Generation of the Soul in the Timaeus* 1014b, Plutarch refers to disorderly time or movement before the cosmos was created; F. E. Brenk, 'Time as Structure in Plutarch's *The Daimonion of Sokrates*', in *Relighting the Souls: Studies in Plutarch, in Greek Literature, Religion and Philosophy, and in the New Testament Background*, ed. Frederick E. Brenk (Stuttgart: F. Steiner, 1998), 59–81, here 74, cites these passages (but with a different goal in mind).

15 Note that this is the same word (in verbal form) as the 'ministering' mentioned by Cleombrotus at 416f: . . . τὴν ἐρμηνευτικὴν . . . καὶ διακονικὴν . . . φύσιν . . .

16 Antiochus, *Thesaurus*, CCAG VII, 127.24–26: Ἡ δὲ Σελήνη προσγειοτέρα οὖσα τὰς ἀπορροίας τῶν ἄνωθεν αὐτῆς δεχομένη ἀστέρων καὶ διακονοῦσα πρὸς τὰ περίγεια, ἄρχει τοῦ ἀνθρωπίνου σώματος παντός.

17 Valens, I, 1.1 (Pingree, 1.5–7): [sc. ὁ Ἥλιος] σημαίνει . . . βασιλείαν, ἡγεμονίαν . . . κρίσιν . . . προστασίαν ὀχλικὴν . . . δεσπότην . . .

18 Translating *daimonion* as 'divine sign' may stem from Plato's *Apology* 40b, where the manifestation of the *daimonion* is called 'the sign of the god' (τὸ τοῦ θεοῦ σημεῖον).

Latin equivalent of δαίμων is given as *genius*, with which the Greek δαίμων had commonalities, although was not identical.)¹⁹ Plutarch compares Socrates' *daimonion* to Athena in the *Iliad*, as something that 'alone "showed him the way, illumining his path", in matters obscure and non-logical to human understanding (φρόνησις)' (580d).²⁰ Thus the daimonic illumines—like the astrological Sun and Moon, the luminaries, who rule sight (physical and mental [in] sight), eyes and foreknowing (*pronoia*).²¹ The Sun and the Lot of Daimon are instruments of this particular illumination, both signifying φρόνησις (which may be described not only as 'understanding' but as 'intentional mind').²² Plato's *Epistle VII* says that when one acquires *phronēsis*, along with *nous*, it 'bursts out in a light' (344b7).²³

The daimon brings us what we already know, which only needs to be brought to consciousness and light, which the daimon can provide. And the more we

In addition to *Apology* 40b, the *daimonion* is also called a 'sign' (σημείον) in *Theages* 129b, d, and *Phaedrus* 242b. P. Hardie, 'Sign Language in *On the Sign of Socrates*', in *Plutarchea Lovaniensia: A Miscellany of Essays on Plutarch*, ed. Luc Van der Stockt, *Studia Hellenistica* (Louvain: Universitas Catholica Lovaniensis, 1996), 136, points out the 'irony . . . in the current English translation as "Sign", [because] τὸ δαίμόνιον in fact is the one case of a *non-sign* in the *De genio*, a signified . . . without a signifier, meaning working directly on the intelligence of Socrates.' Daimonic communication is immediate and unmediated.

- 19 For an excellent discussion of *genius* in antiquity, see J. C. Nitzsche, *The Genius Figure in Antiquity and the Middle Ages* (New York/London: Columbia University Press, 1975), esp. chapters 1 and 2. See also Apuleius on *genius*, *De deo Socratis*, xv.151: Apuleius, *De philosophia libri*, ed. Claudio Moreschini, (Stuttgart/Leipzig: B. G. Teubner, 1991), 25; Apuleius, *Rhetorical works*, trans. Stephen Harrison, John Hilton, and Vincent Hunink (Oxford/New York: Oxford University Press, 2001), 207.
- 20 Plutarch, *De genio Socratis*, trans. Phillip H. De Lacy and Benedict Einarson, in *Moralia*, VII (Cambridge, MA: Harvard University Press, 1959, repr. 2000), 404–05: . . . ἡ 'μόνη 'οί πρόσθεν ἰούσα τίθει φάος' ἐν πράγμασιν ἀδήλοισι καὶ πρὸς ἀνθρωπίνην ἀσυλλογίστοις φρόνησιν. . . . (*Iliad* xx.95; *Moralia*, VII, 405, note d, also cites *Odyssey* XIX.34.) These and subsequent translations from the essays in *Moralia*, VII are modified from De Lacy-Einarson's. D. A. Russell in H.-G. Nesselrath, ed., *Plutarch On the daimonion*, 33, translates the *Iliad* phrase more literally: ' . . . "went before him and gave light" '.
- 21 Valens, I, 1.1–2, 5, 47.
- 22 Paulus, ch. 23, calls the Lot of Daimon φρόνησις; for Valens (I, 1.1) the Sun is φρόνησις. The first sense definition in LSJ for φρόνησις is 'purpose, intention'.
- 23 *Epistula VII*, 344b7 (Burnet, vol. 5.2): . . . ἐξέλαμψε φρόνησις περὶ ἕκαστον καὶ νοῦς. . . . This sudden moment of clarity will not be unfamiliar to anyone involved in creative endeavours, including astrologers who report that, in the best readings, they see the meaning of the symbols in the chart with just such brilliance. See G. Cornelius, *The Moment of Astrology: Origins in Divination*, 2nd ed. (Bournemouth: The Wessex Astrologer, 2004).

follow and are encouraged by our daimon, the more our *phronēsis* increases. In *Timaeus* 90b–c, *phronēsis* grows in power as one cultivates one's daimon:

But he who has seriously devoted himself to learning and to true thoughts (*phronēseis*), and has exercised these qualities above all his others, must necessarily and inevitably think thoughts (*phronein*) that are immortal and divine, if he lays hold of truth . . . and inasmuch as he is always tending his divine part and keeping the daimon who dwells together with him well-ranked, he must be especially good-spirited (*eudaimōn*).²⁴

Within *De genio Socratis*, the Myth of Timarchus reveals a striking vision of astrological, cosmological and religious imagery. Though its important eschatology cannot be examined here,²⁵ its depiction of souls and daimons provides a glimpse of second-century belief in how daimons interact with humans. It is

24 *Timaeus* 90b6–c2, 4–6 (Burnet, vol. 4): . . . τῷ δὲ περὶ φιλομαθίαν καὶ περὶ τὰς ἀληθείς φρονήσεις ἐσπουδακότι καὶ ταῦτα μάλιστα τῶν αὐτοῦ γεγυμνασμένῳ, φρονεῖν μὲν ἀθάνατα καὶ θεία, ἄνπερ ἀληθείας ἐφάπτηται, πάσα ἀνάγκη που . . . ἅτε δὲ αἰεὶ θεραπεύοντα τὸ θεῖον ἔχοντα τε αὐτὸν εὐ κεκοσμημένον τὸν δαίμονα ξύνοικον ἑαυτῷ διαφερόντως εὐδαίμονα εἶναι. Consulting the translations of Bury, in Plato, *Timaeus*, trans. R. G. Bury, in *Plato*, IX (Cambridge, MA: Harvard University Press, 1929, repr. 1989), 246–247 (Bury reads ἐν αὐτῷ for Burnet's ἑαυτῷ in c5); Finamore, 'Plutarch and Apuleius', 39; and the enlightening commentary of A. E. Taylor, *A Commentary on Plato's Timaeus* (Oxford: Clarendon Press, 1928), 633–34 (I thank Stephan Heilen for this reference and advice on the translation). For another example of θεραπεύειν in context with caring for the daimon, cf. Pindar, *Pythian Odes* III, 108–09 (Maehler and Snell): 'and I will revere the daimon always working in my mind, tending it according to my resources', τὸν δ' ἀμφέποντ' αἰεὶ φρασίν / δαίμον' ἀσκήσω κατ' ἐμὴν θεραπεύων μαχανάν. I take εὐ κεκοσμημένον with δαίμονα. My 'especially good-spirited' rather than 'happy' is meant to show the wordplay between δαίμων and εὐδαίμων. This seems to be a different kind of *phronēsis* than the 'practical wisdom' of Aristotle. Yet see the argument of Christopher Long that there are connections between the Platonic idea of *phronēsis* and the Aristotelian one: C. P. Long, *The Ethics of Ontology: Rethinking an Aristotelian Legacy* (Albany, NY: State University of New York Press, 2004), 122–24. For this passage in service to the concept of the personal daimon, see below, 3.1.

25 See, in particular, within scholarship covering this part of the essay, W. Deuse, 'Plutarch's eschatological myths', in *Plutarch On the daimonion of Socrates: Human Liberation, Divine Guidance, and Philosophy*, ed. Heinz-Günther Nesselrath, *SAPERE* (Tübingen: Mohr Siebeck, 2010), 169–198; Y. Vernière, *Symboles et mythes dans la pensée de Plutarque* (Paris: Belles Lettres, 1977), esp. 153–215; Brenk, *In Mist Apparelled*, 136–44; G. Mameli Lattanzi, *Il 'De Genio Socratis' di Plutarco* (Rome: Istituto Poligrafico dello Stato, 1933), 49–63; for the astral components, A. Pérez Jiménez, 'Elementi astrali nei miti di Plutarco', in *Plutarco e la religione. Atti del VI Convegno plutarqueo (Ravello, 29–31 maggio 1995)*, ed. Italo Gallo (Naples: M. D'Auria Editore, 1996), 297–309.

the story of an incubation²⁶ by a (fictional) disciple of Socrates.²⁷ Timarchus's soul leaves its body and sees a vision of the universe, not unlike what happens to Er in the other famous myth. Here, the guide for his cosmological tour is a daimonic voice²⁸ who explains that the moon rescues the souls deemed worthy to escape the reincarnation cycle (and these become daimons), but the others fall away from her and are borne to another life. Timarchus cannot see this, but only 'many stars shaking²⁹ around the chasm, others sinking down into it, and others darting up³⁰ again from below' (591d).³¹ He is told these are daimons themselves, seen as lights which connect to their souls and bodies in life, but released at death. Souls that are too subject to passion and desire sink wholly into the body; in others the purest part remains outside (591d–e). This part is attached like a buoy to the top of the head, and holds the soul upright. *Nous* is the part that is free from passion, which holds the soul upright; we

-
- 26 For more on the practice of incubation, see P. Kingsley, *In the Dark Places of Wisdom* (Inverness, CA: The Golden Sufi Center, 1999), esp. Part Two, 77–89, 101–14.
- 27 On 'Timarchus' as fictional, see Russell in Nesselrath, ed., *Plutarch On the daimonion*, 9 and 94, n. 193; De Lacy and Einarson, in *Moralia VII*, 365, note *a*. Russell suggests Plutarch's choice of the name 'Timarchus' comes from a character in *Theages* 129a; De Lacy-Einarson suggest the name mimics Plutarch's own. De Lacy-Einarson and Vernière, *Symboles et Mythes*, 94, 105, note that both Timarchus and Plutarch are Chaeronean/Boeotian. One could also speculate that 'Timarchus of Chaeronea' amalgamates 'Timaeus' and 'Plutarchus of Chaeronea'.
- 28 There are disagreements about whether the voice is that of a daimon. For example, Finamore, 'Plutarch and Apuleius', 47 and n. 53, thinks its origin is uncertain; in Nesselrath, ed., *Plutarch On the daimonion*, Russell, 95, n. 215, and Deuse, 191, declare it a lunar daimon. I wonder if the 'voice' is meant to recall the voice of Socrates' *daimonion*.
- 29 Greek *παλλομένους*, which in this middle form means precisely 'draw' or 'cast' lots, referring to the shaking of the lots before they are cast (LSJ, s.v. *πάλλω*). In the Myth of Er (*Republic* 617d–e), the souls choose their daimon in an order determined by lot. Using *πάλλω* here in connection to the stars/daimons may thus be intentional. Modern etymology (Chantraine, Tome 1, 246–47; Frisk, Band 1, 340–41) gives possible derivation of *δαίμων* from *δαίωμα*, allot, divide. We could compare the shaking of the dice to humans shaking, both outwardly and inwardly (the flutter in the stomach) when they are about to make a decision.
- 30 A. Setaioli, 'The *Daimon* in Timarchus' Cosmic Vision (Plu. *De Gen. Socr.* 22, 590B–592E), in *Nomos, Dike and Cosmos in Plutarch*, ed. José Ribeiro Ferreira, Delfim F. Leão, and Carlos A. Martins de Jesus (Coimbra: Centro de Estudos Clássicos e Humanísticos da Universidade de Coimbra, 2012), 109–19, here 112 and n. 10, points out that Plato links the same verb *ἄττειν*, 'dart', to stars in *Republic* 621b (the Myth of Er).
- 31 *De genio Socratis* 591d1–3, trans. De Lacy-Einarson, in *Moralia*, VII, 470–471: . . . πολλούς ἀστέρας περὶ τὸ χάσμα παλλομένους, ἑτέρους δὲ καταδυομένους εἰς αὐτό, τοὺς δὲ ἄττοντας αἰὶ κάτῳθεν.

think the *nous* is in us, just as some think a reflected object is in the mirror that reflects it, but in fact it is a daimon external to the body that is *nous* (591e).

The daimonic voice tells Timarchus that what he thinks are extinguished stars are souls that have sunk completely into the body, the stars that appear from below are the souls with their daimons floating back from the body after death, and the stars moving about above are the daimons of men ‘said to have *nous*’ (νοῦν ἔχειν λεγομένων) (591f). This *nous*/daimon resides in the highest part of the soul (591e).³²

Timarchus sees that some stars bob about evenly, but some twist and turn and cannot hold a steady course. The souls ruled by their passions are the ones that are twisting, while those which consent to be ruled by their *nous*/daimon keep an even course. These are the souls that follow their personal daimon (οἰκεῖος δαίμων) from birth (592c) and are rewarded by its aid (594a). The straightness of the obedient soul’s path, and the twisting of the passionate one’s, is analogous, in astronomy, to the steady course of the sun in diurnal motion, and the moon’s more wandering course, which changes in speed, latitude and proximity to earth as it makes its revolution.

The Moirai make an appearance here (591b), as Plutarch puts them in charge of certain regions of the cosmos: Atropos at the border of the fixed stars (where the Monad links life and motion), Clotho on the Sun (where *nous* links motion and birth), Lachesis on the Moon (where Nature [*phusis*] links birth and decay).

1.4 *Where Daimons Dwell: The Face in the Moon*

Vettius Valens calls the Sun the light of the mind and the instrument of the soul’s sense-perception.³³ He says that the Moon, ‘born from the reflection of

32 An idea commonly agreed to derive from *Timaeus* 90a: see W. Hamilton, ‘The Myth in Plutarch’s *De Genio* (589F–592E); CQ 28, no. 3/4 (1934): 175–82, here 180–81; G. Soury, *La démonologie de Plutarque: essai sur les idées religieuses et les mythes d’un platonicien éclectique* (Paris: Les Belles Lettres, 1942), 160; De Lacy and Einarson, in *Moralia VII*, 471 n. d; Vernière, *Symboles et mythes*, 128; Setaioli, ‘The *Daimon* in Timarchus’, 112–13; M. Broze and C. Van Liefferinge, ‘Le démon personnel et son rôle dans l’ascension théurgique chez Jamblique’, in *De Socrate à Tintin. Anges gardiens et démons familiers de l’Antiquité à nos jours*, ed. Jean-Patrice Boudet, Philippe Faure, and Christian Renoux (Rennes: Presses universitaires de Rennes, 2011), 74–75. See also the discussion of *nous*/daimon in Timotin, *Démonologie*, 75–81, who suggests (79) that it links the human soul and intellect to the world-soul and intellect. See below, 3.1, for more on this passage in connection with the personal daimon, an idea also explored by Setaioli, 113–15.

33 Valens, I, 1.1.

the solar light . . . in a nativity signifies humans' life, body. . . .³⁴ Valens' assertion that the moon reflects the sun's light is not his discovery. Plutarch ascribes that observation to Empedocles³⁵ in *De facie quae in orbe lunae apparet*. This essay, an elaborate eschatology of the cosmos and the moon's place within it, again places daimons as inhabitants of the moon (944c–e). The moon is said to be a part of the aither, that highest part of air (943d, e).³⁶ (In the *Epinomis*, some, but not all, daimons also inhabit the aither.³⁷ As Valens notes, quoting Orpheus: 'A human soul is rooted in aither.'³⁸) Purified souls, especially those who have moved the straightest in life, stay here and become daimons. The moon is a repository for souls and is ruled by Persephone. (There are similarities with *De genio Socratis* here.)³⁹ Humans are composed of three parts: body, furnished by the earth; soul, furnished by the moon; and mind (*nous*) furnished by the sun, just as it furnishes light to the moon (943a).⁴⁰

34 Valens, I, 1.4 (Pingree, 1.14–16): <H> δὲ Σελήνη γενομένη μὲν ἐκ τῆς ἀντανακλάσεως τοῦ ἡλιακοῦ φωτός . . . σημαίνει μὲν κατὰ γένεσιν ἀνθρώποις ζῶν, σώμα. . . .

35 At 929e Plutarch says (Cherniss's translation): 'There remains the theory of Empedocles that the moonlight which we see comes from the moon's reflection of the sun'; then quoting Empedocles: "Thus, having struck the moon's broad disk, the ray" comes to us in a refluece weak and faint . . .' (see Empedocles, Frag. B43, in D-K I, 330.20: ὡς αὐγὴ τύψασα σελιναίης κύκλον εὐρύν). See also 936f, 938e on the moon as reflector of the sun's light. Philo, *De providentia* II 70, attributes the same to Empedocles (in Aucher's Latin version of an Armenian text: 'lumen accipiens lunaris globus magnum largumque. . .') See Philo of Alexandria, *De providentia I et II*, trans., intro. and annot. Mireille Hadas-Lebel (Paris: Éditions du Cerf, 1973), 300. Note also that in Plato, *Republic* 616e–617a, the moon's circle gains its colour by reflecting the sun's light.

36 *De facie*, 943d9–10: . . . τῷ περὶ τὴν σελήνην αἰθέρι. . . ; 943e10: . . . οὕτως τῷ αἰθέρι λέγουσι τὴν σελήνην ἀνακεκραμένην. . . . In *Moralia*, XII, 202, 204.

37 See *Epinomis*, 984d–e. See also L. Tarán, *Academica: Plato, Philip of Opus, and the Pseudo-Platonic Epinomis* (Philadelphia: American Philosophical Society, 1975), 42–46. Tarán argues, 44, that daimons in *Epinomis* are *only* of aither (an argument which does not quite convince me). In Bacchylides, 3.35–38, the 5th-century BCE poet has Croesus address a daimon by raising his hands to the aither: see Bacchylides et al., *Bacchylides, Corinna and Others*, ed. and trans. David A. Campbell, in *Greek Lyric*, IV (Cambridge, MA: Harvard University Press, 1992), 128–29.

38 Valens, IX, 1.12 (Pingree, 317.20): ψυχὴ δ' ἀνθρώποισιν ἀπ' αἰθέρος ἐρριζώται. (The same in O. Kern, *Orphicorum fragmenta* (Berlin: Weidmann, 1922), 244, Fr. 228a.) Cf. also Chapter 10, 1.8.

39 See the more extensive comparison between the 2 myths in Hamilton, 'The Myth in *De genio*', esp. 176–77.

40 *De facie*, 943a9–11, in *Moralia*, XII, 198: . . . τὸ μὲν σῶμα ἢ γῆ τὴν δὲ ψυχὴν ἢ σελήνη τὸν δὲ νοῦν ὁ ἥλιος παρέσχεν εἰς τὴν γένεσιν <τῶν ἀνθρώπων> ὡς περ αὐ<τῆ> τῆ σελήνη τὸ φέγγος. F. Cumont, 'La théologie solaire du paganisme romain', in *Mémoires présentés par divers savants à*

The Moirai, too, are involved: 'Of the three Fates too Atropos enthroned in the sun initiates generation, Clotho in motion on the moon mingles and binds together, and finally upon the earth Lachesis too puts her hand to the task, she who has the largest share in fortune/chance (*tuchē*).'⁴¹

This triad of earth, moon and sun becomes the macrocosmic matrix for the generation of the human body, soul and mind. A variation on this theme also appears in astrology, where the Sun represents *nous* and daimon, and the Moon body and fortune.⁴² As (respectively) the lots of the Moon and Sun, the Lots of Fortune and Daimon expand these designations.⁴³ The Fortune lot combines *De facie*'s functions of the earth and the Moon, since its concerns are with the body and what happens to it in the physical world; the Daimon lot combines the functions of *De facie*'s Sun and Moon, ruling over matters concerning both mind and soul.⁴⁴

In the astrological praxis of these lots, which may be performed for purely mundane reasons, is a tangible demonstration of philosophical and even religious principles behind their formation. Both in astrology and in Plutarch, the pairs of sun and moon, and the triads of mind, soul and body amalgamate into systems reflecting similar sensibilities. Mind and soul, Sun and Moon, matter

l'Académie des Inscriptions et Belles-Lettres (Paris: C. Klincksieck, 1909), 18 and n. 3, 27–29, suggests that Plutarch derived the eschatological ideas in *De facie* from Posidonius.

41 945c12–945d4: και τριῶν Μοιρῶν ἡ μὲν Ἄτροπος περὶ τὸν ἥλιον ἰδρυμένη τὴν ἀρχὴν ἐνδίδωσι τῆς γενέσεως, ἡ δὲ Κλωθῶ περὶ τὴν σελήνην φερομένη συνδεῖ καὶ μίγνυσιν, ἐσχάτη δὲ συνεφάπτεται περὶ γῆν ἢ Λάχσεις ἣ πλείστον τύχης μέτεστι. (Trans. Cherniss.) Note the different assignments of the Fates to those in *De genio* 591b, where Clotho is associated with the sun and Lachesis with the moon. Both of *De genio*'s assignments involve birth, but one (Clotho) highlights the connections between (heavenly) movement and birth, while the other (Lachesis) emphasises the result of earthly incarnation (decay following birth). Since the moon is a hybrid of the heavenly and earthly, there is some justification for assigning it to two different Moirai in two contexts. See De Lacy-Einarson, 221 note *b*; also Hamilton's reconciliation of these two schemes (Hamilton, 'The Myth in *De genio*', 177).

42 Sun: Valens, IV, 4.2; Paulus, ch. 23. Moon: Valens, I, 1.4, IV, 4.2, IX, 2.2; Paulus, ch. 23. Cumont's essay (as in n. 40) provides the astrological and near eastern context for the 'solar theology' popular in the Greco-Roman period.

43 See the definition and description of these in the Introduction, 3.2 and Fig. 1.2, 7–8.

44 Paulus, ch. 23 (Boer, 49.17–22), says: 'And Fortune signifies all things about the body and actions throughout life. It becomes indicative of acquisition, reputation and privilege. Daimon happens to be lord of soul, temper, intentional mind and every capability... και ἡ μὲν Τύχη σημαίνει τὰ περὶ τοῦ σώματος πάντα καὶ τὰς κατὰ βίον πράξεις· κτήσεως τε καὶ δόξης καὶ προεδρίας δηλωτικὴ καθέστηκεν. ὁ δὲ Δαίμων ψυχῆς καὶ τρόπου καὶ φρονήσεως καὶ δυναστείας πάσης κύριος τυγχάνει... See also Antiochus in *CCAG* I, 160.12–16 (find quotation in the Introduction, 8, n. 28); Valens II, 20.1; Chapter 9, Table 9.1, 306 in this book.

and spirit, all are integrated in an astrology that seems very close to the philosophical and religious system described by Plutarch.

2 The Daimon, Fate, Providence and Astrology

Plutarch's inclusion of the Moirai in schemes of life, movement and generation, as well as giving them heavenly or earthly assignments, prompts discussion of another essay from this period, *On Fate* (Περὶ εἰμαρμένης). Portions of this Middle Platonic essay will be relevant to our discussion of the daimon and fate. The importance of these concepts to Vettius Valens in regard to astrology and his personal life will then emerge in our discussion of the second-century astrologer's experience with the daimon, providence and fate.

2.1 *Pseudo-Plutarch*⁴⁵ on Fate

Though not considered now as genuine Plutarch, the ideas conveyed in *On Fate* circulated in the common philosophical culture of the day,⁴⁶ and its second-century date puts it in Valens' era. While no direct evidence establishes that Valens was acquainted with this essay, or even with any of Plutarch's writing, there are distinct similarities with the way *On Fate* deals with fate, and the way Valens deals with it.⁴⁷ The essay sets out a model of fate which

45 For authorship, see J. Dillon, *The Middle Platonists: A Study of Platonism 80 BC to AD 220* (London: Gerald Duckworth and Company, 1977), 295, 320; Greene, *Moirai*, 370; *Moralia*, VII, 303; Plutarch, *Oeuvres morales, Tome VIII. Du destin—Le démon de Socrate—De l'exil—Consolation à sa femme*, ed. and trans. Jean Hani (Paris: Les Belles Lettres, 1980), 3–7; M. Dragona-Monachou, 'Divine Providence in the Philosophy of the Empire', in *ANRW*, vol. II, 36.7, ed. Wolfgang Haase (Berlin: De Gruyter, 1994), 4461–62.

46 Dillon, *Middle Platonists*, 320–26, here 320: 'Apuleius' account . . . exhibits the distinctive features of the more elaborate account of Fate, Providence and Free Will given by the author of *De Fato* falsely ascribed to Plutarch, and by Calcidius, and reported more briefly by Nemesius of Emesa in his work *On the Nature of Man*. None of these documents is directly dependent on the others, yet they are so closely akin in terminology as to make it necessary that they derive from a common source.' See also Dragona-Monachou, 'Divine Providence', 4454–55, 4461–64, for a cogent explanation of fate and providence in this period, here 4464: 'This doctrine [a threefold providence], for all its shortcomings, had a significant influence on later discussions.'

47 Komorowska, *Valens*, 295–98, 301–03, 308–10, has also explored these topics; her work has been useful in formulating my own positions. Another study of this essay in relation to astrology in general is M. Lawrence Moore, 'The Young Gods: The Stars and Planets in Platonic Treatment of Fate', in *Perspectives sur le néoplatonisme. International Society of*

is ‘compatible with providence’ and some kind of free will.⁴⁸ It first explains what fate *is* (its οὐσία) and what it *does* (its ἐνέργεια).⁴⁹

Fate (εἰμαρμένη) in its essential being (or substance) (κατ’ οὐσίαν) seems to be the entire soul of the cosmos divided into three—into a non-wandering portion of fate [*i.e. the fixed stars*], a portion called wandering [*i.e. the planets*], and a third portion below the heavens which concerns the earth. . . . (568e).⁵⁰

As *energeia*, fate is a law (568d) and sets boundaries (569a). (In Hermetic texts, daimons are connected with *energeia*, and provide a medium of action and interaction with humans: ‘They [*sc. daimons*] are both good and bad in their natures, that is, their activities [*energeia*]; for the essence [*ousia*] of a daimon is activity. . . .’⁵¹ Thus the Hermetic text equates the daimon’s essence with its activity, rather than differentiating the two characteristics.) (See Chapter Six for more on Hermetism and daimons.) Fate manifests, or becomes ‘actual’ in the world by ‘enclos[ing] all events *in a cycle*, and it is ‘not infinite but finite, for neither a law (νόμος) nor a formula (λόγος) nor anything divine can be infinite’ (569a, my italics).⁵² Time, shown in the movement of the ‘eight revolutions’ (the planets and fixed stars), is also ‘definite and knowable’ (ὠρισμένος . . . καὶ

Neoplatonic Studies. Actes du colloque de 2006, ed. Martin Achard, W. J. Hankey, and Jean-Marc Narbonne (Quebec: Presses de l’Université Laval, 2009), esp. 96–97, 102–09.

48 Pseudo-Plutarch, *De fato*, trans. Phillip H. De Lacy and Benedict Einarson, in *Moralia*, VII (Cambridge, MA: Harvard University Press, 1959, repr. 2000), Introduction, 304.

49 I thank †Robert Sharples (personal communication) for supplying this apt description.

50 *De fato*, 568e2–5 (Sieveking): Ἡ [sc. εἰμαρμένη] <δὲ> κατ’ οὐσίαν ἔοικεν εἶναι σύμπασ’ ἢ τοῦ κόσμου ψυχὴ τριχῆ διανεμηθεῖσα, εἷς τε τὴν ἀπλανῆ μοῖραν καὶ εἰς τὴν πλανᾶσθαι νομιζομένην καὶ τρίτην [εἰς] τὴν ὑπουράνιον τὴν περὶ γῆν ὑπάρχουσαν. . . . The ‘distinctive’ (to use Dillon’s word in *Middle Platonists*, 320) ideas expressed in this essay about the three forms of fate and providence may come out of Athenian scholasticism of the early 2nd century, or the (as yet uncertain) teacher(s) of Apuleius: see Dillon, *Middle Platonists*, 320, 338. Calcidius (*Commentary on Timaeus* 143a–144a), Nemesius (*On the Nature of Man* 43) and Apuleius (*De Platone* I, 12) also write of this schema in the 4th and 2nd centuries; again see Dillon, *Middle Platonists*, 294–96, 320–26. See also the discussion in J. den Boeft, *Calcidius on Fate: His Doctrine and Sources* (Leiden: E. J. Brill, 1970), 8–34.

51 *CH* XVI, 13.5–6 (Nock and Festugière, *CH* II, 236.8–9): . . . ἀγαθοὶ καὶ κακοὶ ὄντες τὰς φύσεις, τουτέστι τὰς ἐνεργείας. δαίμονος γὰρ οὐσία ἐνέργεια. . . .

52 *De fato*, 569a2–5 (Sieveking): τὰ πάντα περιβαλοῦσ’ ἐν κύκλῳ ἢ εἰμαρμένη οὐκ ἄπειρος ἀλλὰ πεπερασμένη ἐστίν· οὔτε γὰρ νόμος οὔτε λόγος οὔτε τι θεῖον ἄπειρον ἂν εἴη. (Trans. De Lacy-Einarson, 317 [slightly modified].)

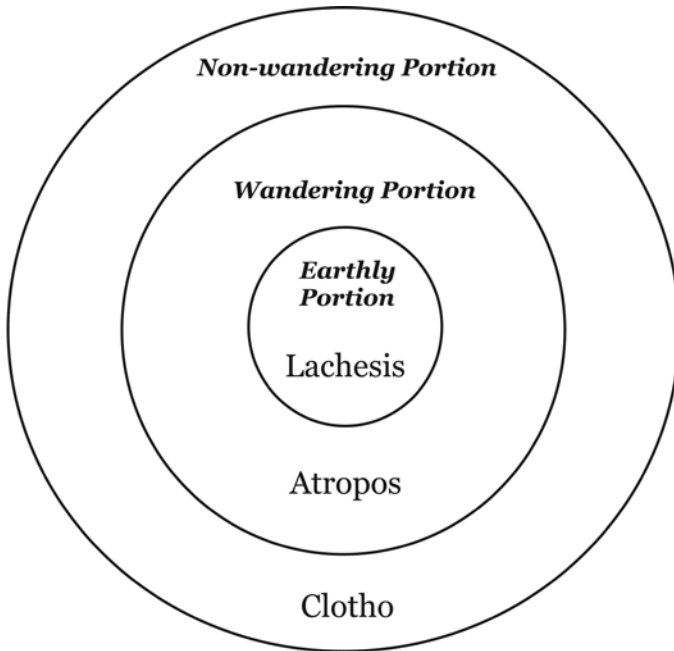

FIGURE 1.1 *The three levels of fate* (Heimarmenē).

θεωρουμένος) and moves in repeating cycles (569a).⁵³ Thus planets, stars and their cycles are integral to both explanations of fate, its essence and its activity. Each level of fate is assigned one of the Moirai: Clotho the highest, Atropos the middle and Lachesis the lowest (568e).⁵⁴

But the heavenly bodies alone are not the causes of everything (569b–c). There is something above fate—*πρόνοια*, providence (‘foresight’, or ‘fore-knowing’). Though all is contained in fate (in that fate itself is a container), not everything ‘conforms to fate’ (καθ’ εἰμαρμένην) (570b–d).⁵⁵ *Pronoia*, in fact, can supersede *heimarmenē*—and like *heimarmenē*, there are three kinds of providence.⁵⁶ The essayist says:

53 This is a reference to Plato’s Great Year (*Timaeus* 39d). Cf. G. de Callataj, *Annus Platonicus: a study of world cycles in Greek, Latin and Arabic Sources* (Louvain-La-Neuve: Université Catholique de Louvain, Institut Orientaliste, 1996).

54 Note that the only consistency with *De facie*’s assignment of the Fates to heavenly bodies is Lachesis, who governs earth in both schemes.

55 See Pseudo-Plutarch, *De fato*, ed., trans. and comm. Ernesto Valgiglio (Rome: A. Signorelli, 1964), 57–58 (comm.) I follow Valgiglio’s explanation that being ‘contained’ in fate does not mean being subject to it (i.e. ‘conforming to fate’).

56 The concept of three kinds of providence was not limited solely to this essay of Pseudo-Plutarch’s. R. W. Sharples, ‘Threefold Providence: The History and Background of a

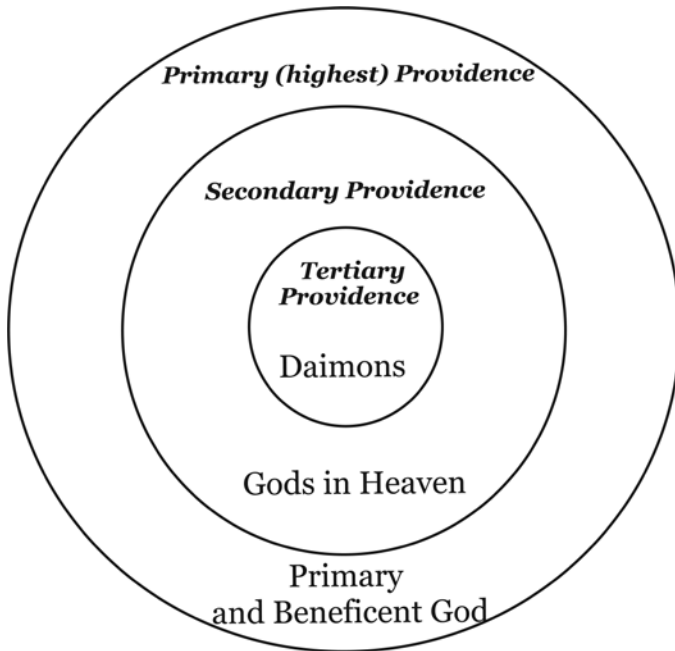

FIGURE 1.2 *The three levels of providence.*

It remains to speak of *providence*, as it in turn includes *heimarmenē*. The highest and primary providence is the intellection (or mindfulness: νόησις) or even will of the primary god, which is beneficent to all. . . . Secondary providence belongs to secondary gods, who move in heaven, and in conformity with it all mortal things come into being in orderly fashion. . . . The providence and forethought which belongs to the daimons stationed in the terrestrial regions as guardians and overseers of human actions would reasonably be called tertiary (572f–573a).⁵⁷ [*Italics mine.*]

Doctrine', in *Ancient Approaches to Plato's 'Timaeus'*, *BICS Supplement* 78 (2003), 107–27 has written about other texts which address a threefold providence (in particular Apuleius, *De Platone* and Nemesius, *De natura hominis*), showing their common structure and origin from Plato.

57 *De fato*, 572f2–7, 8–9, 573a1–6, in *Moralia*, VII, 342–43: λοιπὸν δ' ἂν εἶη καὶ περὶ προνοίας εἰπεῖν, ὡς αὐτὴ γε περιεῖληφε τὴν εἰμαρμένην. Ἔστιν οὖν πρόνοια ἢ μὲν ἀνωτάτω καὶ πρώτη τοῦ πρώτου θεοῦ νόησις εἴτε καὶ βούλησις οὐσα εὐεργέτις ἀπάντων. . . ἢ δὲ δευτέρα δευτέρων θεῶν τῶν κατ' οὐρανὸν ἰόντων, καθ' ἣν τὰ τε θνητὰ γίνεται τεταγμένως. . . τρίτη δ' ἂν εἰκότως ῥηθεῖη πρόνοια τε καὶ προμήθεια τῶν ὅσοι περὶ γῆν δαίμονες τεταγμένοι τῶν ἀνθρωπίνων πράξεων φύλακες τε καὶ ἐπίσκοποι εἰσι. (De Lacy-Einarson trans., modified.)

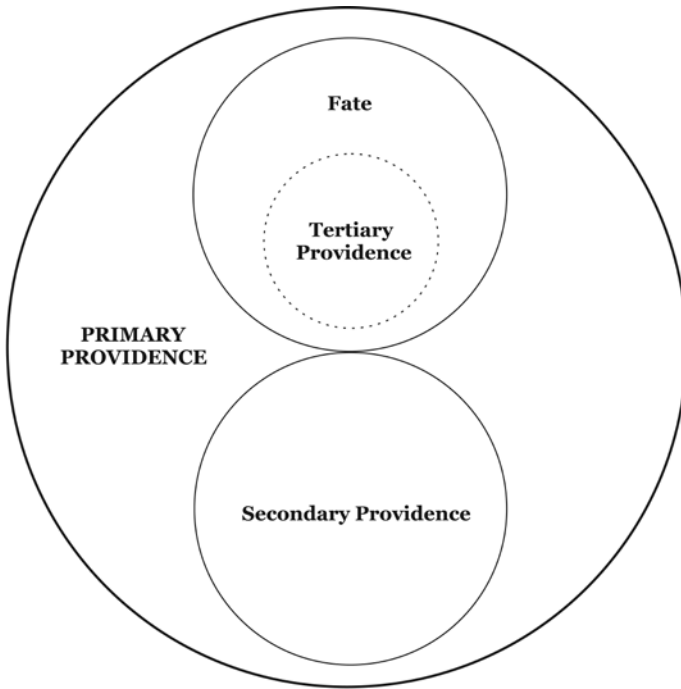

FIGURE 1.3 *Fate included in providence.*

Tertiary providence is daimonic and available in the human realm. It operates within *heimarmenē* (which includes planets and stars), but allows some choice⁵⁸ (and primary *pronoia* includes *heimarmenē*):

As providence is threefold, the first, since it has begotten fate, includes it in a sense; the second, having been begotten together with fate, is most certainly included together with it; and the third, since it is begotten later than fate, is contained in it in the same way as what is in our power and chance were said to be contained in fate.⁵⁹

58 Valgiglio, *De fato*, 57, says that tertiary providence can work on antecedents, but the consequents are subject to fate (i.e., the events following from the antecedent are then fated). *Pronoia* does not conform to fate and allows for some choice (antecedent), even though once the choice is made, the events that follow (consequent) do conform to fate.

59 *De fato*, 574b1–6, in *Moralia*, VII, 350–51: τριττῆς γὰρ οὐσης τῆς προνοίας ἡ μὲν, ἅτε γεννήσασα τὴν εἰμαρμένην, τρόπον τινὰ αὐτὴν περιλαμβάνει, ἡ δὲ, συγγεννηθεῖσα τῇ εἰμαρμένῃ, πάντως αὐτῇ συμπεριλαμβάνεται, ἡ δὲ, ὡς ὕστερον τῆς εἰμαρμένης γεννωμένη, κατὰ τὰ αὐτὰ δὴ ἐμπεριέχεται ὑπ' αὐτῆς καθ' ἃ καὶ τὸ ἐφ' ἡμῖν καὶ ἡ τύχη εἴρηται. (De Lacy-Einarson trans., 351.)

When the *daimonion* is at work, it is partaking of tertiary *pronoia*, the kind of *pronoia* that humans can know about and use:

For, ‘those whom the power of the *daimonion* may assist in conversation,’ as Socrates says . . . ‘are the ones you have remarked; for their progress is immediate and rapid.’ [*Theages* 129e] . . . the encouragement given to association with certain persons by the *daimonion* conforms to tertiary providence, while their immediate and rapid progress conforms to fate; and the whole complex is plainly enough none other than a form of fate.⁶⁰

Could tertiary *pronoia*, the provenance of the guarding and interpreting daimons, operating in (though not entirely conforming to) a *heimarmenē* of planets and stars, provide a philosophical means for astrology to work, and to be interpreted? Valens may provide an application of this model in second-century astrology.

3 Vettius Valens’ Daimon and Providence

3.1 *The Personal Daimon*

Tertiary providence is the realm of the daimon, and its encouragement causes progress which then conforms to fate (and always overseen by primary providence). The *On Fate* essayist cites Socrates’ *daimonion* as providing this *pronoia*, but are there other examples of daimons acting in this way? Apart from the daimons of famous men mentioned by Plutarch in his *Parallel Lives*,⁶¹ there are two second-century examples, one from medicine and one from astrology.

Galen is one who claims to have a personal daimon.⁶² In *On the Usefulness of the Parts* (*De usu partium*), he tells us his daimon ordered him to write about the optic chiasma (the junction where the two parts of the optic nerve converge, allowing our two eyes to see one image). In both places where he speaks about

60 *De fato*, 574b6–8, 9–11, c1–3, in *Moralia*, VII, 350–53: ‘οἷς’ γὰρ ‘ἂν συλλάβηται τῆς συνουσίας ἢ τοῦ δαιμονίου δύναμις,’ ὡς φησι Σωκράτης . . . ‘οὔτοι εἰσιν ὦν καὶ σὺ ἤσθησαι: ταχὺ γὰρ παραχρῆμα ἐπιτιδόασιν.’ . . . τὸ μὲν συλλαμβάνειν τισὶ τὸ δαιμόνιον κατὰ τὴν τρίτην πρόνοιαν . . . τὸ δὲ ταχὺ παραχρῆμα ἐπιτιδόναι καθ’ εἰμαρμένην: τὸ δὲ ἕλον οὐκ ἄδηλον ὡς αὐτὸ τοῦτο εἰμαρμένη τις ἐστὶ. (De Lacy-Einarson trans., slightly modified.)

61 See above, n. 4.

62 For Galen, I follow H. von Staden, ‘Galen’s daimon: reflections on «irrational» and «rational»,’ in *Rationnel et irrationnel dans la médecine ancienne et médiévale: aspects historiques, scientifiques et culturels*, ed. Nicoletta Palmieri (Saint-Étienne: Publications de l’Université de Saint-Étienne, 2003), 15–43.

the daimon, it is to tell us that the daimon ‘ordered’ or ‘commanded’ him to fulfil his wishes.⁶³ The daimon communicated to Galen in dreams.⁶⁴ Galen apparently conceived of his daimon along Platonic lines: in *On Habits (De consuetudinibus)*, he quotes Plato’s *Timaeus* 90a–c, explaining the daimon as something given by god which inhabits the most authoritative part of the soul, in the highest part of the body.⁶⁵ This corresponds to what we saw in Plutarch: in *De genio*, the *nous*/daimon even floats *above* the body and the personal daimon also plays a rôle (*De genio* 592c, 594a) (cf. 1.3 above).⁶⁶ Galen’s quotation includes Plato’s word-play on daimon and *eudaimonia*⁶⁷ (see 1.3, 23 and n. 24); the same association may have been in Valens’ mind when writing about finding happiness through the birth chart using the Lot of Daimon (II, 20).

3.2 Daimonion in the Anthology: First Appearance

Not surprisingly, given the importance of the daimon in his astrology, Vettius Valens also claims to have been contacted by the *daimonion*.⁶⁸ Throughout the *Anthology* he refers to astrology as a kind of mystery, whose knowledge is not only acquired through hard work but through revelation,⁶⁹ to those who are worthy to know it, and he specifically mentions daimon and *pronoia* as an aid in his discoveries.⁷⁰

The *daimonion* is mentioned four times in the *Anthology*. The first is at II, 13.1, where Valens says that if a benefic (Jupiter or Venus) in the fourth place is the lord of the Lot of Fortune or the Hour-marker, the native will be given ‘revelations by *daimonia*’ (ὕπὸ δαιμονίων . . . χρηματισθήσονται). Obviously the reference is not to Valens’ personal daimon, though it does imply such visitations are beneficial. (Nor does this particular criterion apply to what is probably

63 *De usu* x, 12 (Kühn, III, 828): κελεύσαντος δαίμονος; and *De usu*, x, 14 (Kühn, III, 832): ἐμοὶ μὲν δὴ πεπλήρωται τὸ τοῦ δαίμονος πρόσταγμα . . ., cited in von Staden, ‘Galen’s daimon’, 30.

64 *De usu* x, 12 (Kühn, III, 812–13), cited in von Staden, ‘Galen’s daimon’, 32.

65 I.e. the rational soul. *De consuetudinibus*, IV (126–27 Dietz = ed. Marquardt, Müller and Helmreich [*Scripta Minora*], 26–27), cited in von Staden, ‘Galen’s daimon’, 33.

66 But Timotin, *Démonologie*, 80, does not consider this passage in *Timaeus* to include the concept of a personal daimon.

67 *Ibid.*

68 See the discussion of this topic in Komorowska, *Valens*, 346–51, which has been helpful for my own treatment of it.

69 For more on divine revelation, see A.-J. Festugière, *La révélation d’Hermès Trismégiste*, 3 vols., vol. 3, *Les doctrines de l’âme* (Paris: Les Belles Lettres, 1950, repr. 1989, 2006), 309–54; Valens is mentioned on 318.

70 Valens speaks of being ‘exalted because of the heavenly theory poured over me by the daimon . . .’ (VI, 1.7, Pingree, 230.25–26: . . . σεμνυόμενος ἐπὶ τῇ περιχυθείσῃ μοι ὑπὸ τοῦ δαίμονος οὐρανία θεωρία . . .).

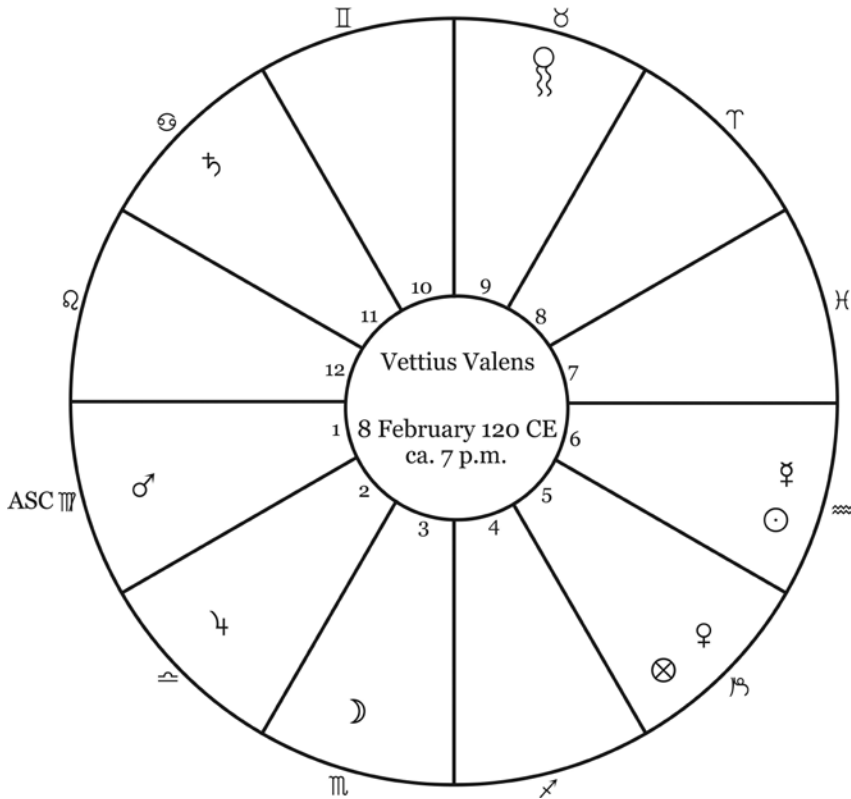

FIGURE 1.4 Probable birthchart of Vettius Valens.

Valens' own chart—which is cited twenty-one times in the *Anthology*,⁷¹ but Venus is the lady of his Lot of Daimon [the Lot falls in Taurus, Venus's house]—and Daimon falls in the ninth place, the place of astrologers, mysteries and god. Venus is also conjunct the Lot of Fortune in the fifth place, where she rejoices.)

71 In Books I, II, III, IV, V and VII. For the example in Figure 1.4, see O. Neugebauer and H. B. Van Hoesen, *Greek Horoscopes* (Philadelphia: The American Philosophical Society, 1959, repr. 1987), 116–17, 180–81, No. L120, II. The Lots of Fortune and Daimon in Figure 1.4 have been calculated with the values given by Neugebauer and Van Hoesen.) Pingree believed that this chart was Valens' (see his edition, v; also xix where the 21 citations of the chart are listed); M. Riley, 'Survey of Vettius Valens', 1, 23; and W. Hübner, 'Vettius Valens', col. 150, concur, though Komorowska, *Valens*, 17–18, is less certain. However, it would not be unusual for him to give his own chart as an example: the astrologer Manetho provides his chart in *Apotelesmatika*, Book VI.738–750: see R. Lopilato, 'The "Apotelesmatika" of Manetho' (Ph.D. thesis, Brown University, 1998), 140, 304, 442 (the chart appears in Neugebauer and Van Hoesen, *GH*, 92, No. L 80); also Hephaestio, *Apotelesmatica*, at II, 1.32–34; II, 2.22–26; and II, 11.6–7 (in *GH*, 131–32).

3.3 *The Daimonion and Pronoia: Second Appearance*

Daimonion appears for the second time at IV, 11.7, as Valens recounts his search for an astrology teacher:

And at that point, we spent much time wretchedly, and while we were sadly moving from place to place, associating with those who have seriously studied such things, we kept on experimenting, until the wished-for *daimonion*, through a certain providence (*pronoia*), made the transmission in a certain place through a certain man who loved learning.⁷²

The phrase ‘wished-for *daimonion*’ offers the possibility that Valens has had this kind of experience previously and, remarkably, it then arrives through a certain *pronoia*! Within the next few lines, Valens asks his readers to swear an oath not to reveal this knowledge to the unworthy, and they are asked to swear not only by the stars but by *pronoia* itself:

I entreat you, my most honoured brother, and those being initiated into the mysteries with this composition, by the starry vault of heaven and twelvefold-zodiacal circle, by both the Sun and Moon, and the 5 wandering stars through which all life is driven, by both Providence itself and holy Necessity, to keep these things in secret. . . .⁷³

Can there be any doubt of Valens’ belief in *pronoia* here? He includes *pronoia* along with his beloved zodiac, stars and planets, the tools of his livelihood and his passion. In Book IX, he also makes clear his debt to providence (and God) for his astrological knowledge: ‘And so while sailing on the open sea and traveling through many a land, becoming an explorer of regions and races, plunged

72 Valens, IV, 11.7 (Pingree, 163.13–17): και δὴ πολὺν μὲν χρόνον ἀνιαρῶς διήγομεν, καὶ ἐπιλύτως τὰς μεταβολὰς τῶν τόπων ποιούμενοι, τοῖς περὶ τὰ τοιαῦτα ἐσπουδακῶσι συμμίσγοντες, διάπειραν ἐλαμβάνομεν, μέχρις οὗ τὸ δαιμόνιον βουλευθὲν διὰ τινος προνοίας τὴν παράδοσιν ἔν τινι τόπῳ πεποιήται διὰ τινος φιλομαθοῦς ἀνδρός.

73 Valens IV, 11.11 (Pingree, 163.25–29): Ὁρκίζω σε, ἀδελφέ μου τιμιώτατε, καὶ τοὺς μυσταγωγούμενους ταύτῃ τῇ συντάξει οὐρανοῦ μὲν ἀστέριον κύτος καὶ κύκλον δυοκαίδεκάζωδον, Ἥλιόν τε καὶ Σελήνην καὶ τοὺς ἑπταπλάνητας ἀστέρας δι’ ὧν ὁ πᾶς βίος ἡνιοχεῖται, αὐτὴν τε τὴν πρόνοιαν καὶ τὴν ἱεράν ἀνάγκην, ἐν ἀποκρύφοις ταῦτα συντηρήσαι. . . . The inclusion of ‘holy Necessity’ here, and its implications in fate and astrology, cannot be addressed here (but see Chapter 10). But recall that the Moirai are daughters of Necessity; in astrology there is a Lot of Necessity, and Saturn is said to rule ‘ignorance and necessity’ (Valens I, 1.47). Macrobius, *Saturnalia* I, 19.17 alludes to Fortune, Daimon, Necessity and Eros; and *Commentary on the Dream of Scipio* I, 6.37–40 mentions Necessity and elements.

into labours in a long-standing experiment, I was thought fit by God and providence (*pronoia*) to light upon a secure and safe harbour.⁷⁴

When the *daimonion* is at work, according to *De fato*, it operates through tertiary *pronoia*, the kind of *pronoia* available to humans. When Valens says that he was given the gift of astrology through god and providence (via the *daimonion*), is this a combination of primary (godly) and tertiary (daimonic) *pronoia*? Could this be the kind of *pronoia* he means? Could he have known the ideas of primary, secondary and tertiary *pronoia*?⁷⁵ He assigns *pronoia* to the Moon, which fits with Plutarchian ideas about daimons, *pronoia* and the moon—possibly evidence for Valens being acquainted with such treatises.⁷⁶ Other passages of Valens⁷⁷ suggest he believes the power of *heimarmenē* is absolute, but these statements about *pronoia*, applied to his own life, tell a different story.

How does Valens conceive of providence? In the ‘oath’ passages (IV, 11.11; VII, 6.231), Valens exhorts his readers to swear by Providence; the context meaning here leans more toward providence as an overarching order in the cosmos. But in the other passages previously quoted (IV, 11.7: ‘... the wished-for *daimonion*, through a certain providence, made the transmission...’; and IX, 1.10: ‘I was thought fit by God and providence to light upon a secure and safe

74 Valens, IX, 1.10 (Pingree, 317.10–13): πελαγοδρομήσας οὖν και πολλήν γήν διοδεύσας, κλιμάτων τε και ἔθνων κατόπτησ γενόμενος, πολυχρονία πείρα και πόνοις συνεμφυρείς, ἤξιώθην ὑπό θεοῦ και τῆς προνοίας βεβαίου και ἀσφαλοῦς λιμένος τυχεῖν. The sentence is based on Critodemus (Valens has added the words ‘and providence’).

75 Komorowska, *Valens*, 309–10, 351 also suggests this, though of course there can be no certain proof. However, we should not pass over the striking similarity of thought between what Valens says in v, 6.4 (‘For fate has ordained by law for each an unchangeable actuality of outcomes...’ [Pingree, 209.10–11: Νενομοθέτηκε γάρ ἡ εἰμαρμένη ἐκάστω ἀμετάθετον ἀποτελεσμάτων ἐνέργειαν...]) and what is expressed in *On Fate* 568b–d (fate as a law). See below, 39–40, 42, nn. 85, 86 and 91, where Valens again mentions fate as a law and talks about what is ‘possible’ (τὸ δυνατὸν), using the technical term mentioned in *On Fate* 571b, as well as ‘chosen plan’ (προαίρεσις), the term used in *On Fate* 571d, to describe things that are, in the view of the essayist, ‘up to us’ (ἐφ’ ἡμῖν) and ‘by choice’ (κατὰ προαίρεσιν).

76 We might otherwise expect that in astrology *pronoia*, which clearly must have an association with *nous*, would be assigned to the Sun. On the other hand, the Moon represents the material world, and the body, which will be finally affected by any kind of *pronoia*. We may, in fact, acquire a measure of *pronoia* by being in tune with the material world, represented by the Moon.

77 E.g., v, 6.4 (n. 75); IX, 12.19 (see below, 39–40).

harbour'),⁷⁸ Valens is treating *pronoia* not so much as an ordering principle with *heimarmenē* as its enforcer, but as a divine intervention.⁷⁹

In this context, the very fact that Valens believes in this kind of Providence militates against a hard determinism: as Philippe Merlan says, 'strict determinism seems to leave no place for providence in any genuine sense of the word.'⁸⁰ If this is so, then Valens' belief in providence means that he cannot be a strict determinist. Merlan was speaking in reference to Stoicism; but Middle Platonists, as well, 'defended divine providence against fatalism'.⁸¹

Furthermore, Valens' comments about seeking virtue through studying astrology (e.g. v, 6.9, 8.112; VI, 1.15–16)⁸² and following his own daimon (see below) also demonstrate an anti-hard determinism stance from the Stoic point of view, in that he is making a choice which appears to have elements of freedom. His decision also would be analogous to the antecedent provided by tertiary providence in *De fato*, but the consequents of his decision are subject to fate (see n. 58). While one ought not to categorise Valens' philosophical positions as either Stoic or Platonic (they are, to put it gently, eclectic, if not

78 See also Valens, Appendix 1, 101 (Pingree, 377.23–27), which refers to the recovery of sight 'by divine providence', though we cannot be certain that this is not an interpolation by a later commentator.

79 Sharples, 'Threefold Providence', 109, n. 4, notes that the definition of providence can move in two ways: 'in terms of the preservation of order or in terms of divine intervention changing the course of events that would otherwise follow.' In the contexts of the texts Sharples discusses, he implies the former is more likely and that the latter is subordinate; but he does not mention Valens. J. M. Rist, *Stoic Philosophy* (Cambridge: Cambridge University Press, 1969, repr. 1980), 126, says that for the Stoics, providence means 'foreseeing and foreseeing correctly'. We cannot know if Valens would have this meaning in his mind.

80 P. Merlan, 'The Stoa', in *The Cambridge History of Later Greek and Early Medieval Philosophy*, ed. A. H. Armstrong (Cambridge: Cambridge University Press, 1967), 124 (quoted in Dragona-Monachou, 'Divine Providence', 4453–54).

81 Dragona-Monachou, 'Divine Providence', 4455. See also Komorowska, *Valens*, 298: 'Among the traditional arguments against the assumption of radical determinism, three are directly related to the concept of divine Providence . . .'

82 VI, 1.15–16 (Pingree, 232.6–10) is especially illustrative of this: . . . ἀλλὰ θεῖα καὶ σεβασμῖα θεωρεῖα τῶν οὐρανίων ἐντυχῶν ἠβουλήθη καὶ τὸν τρόπον μου ἐκκαθάραι πάσης κακίας καὶ παντὸς μολυσμοῦ καὶ τὴν ψυχὴν ἀθάνατον προλήψαι. ἔνθεν καὶ τὰ θεῖά μοι προσομιλεῖν ἐδόκει καὶ τὸ διανοητικὸν μου πρὸς τὴν ἀναζήτησιν νηπτικὸν ἐκεκτῆμην. ' . . . but when I lit upon the divine and revered theory of the heavens, I wished to purify my way of life of every vice and pollution, and anticipate the immortal soul. From that point divine things seemed to converse with me, and I acquired the intellectual capacity for sober investigation.'

inconsistent),⁸³ his intention here counts for something, at least where freedom to choose virtue and follow the daimon is concerned: that he is aware of a choice to be made also militates against strict determinism. By choosing to follow the daimon and to be virtuous (with astrology as his means for this) he obtains *gnosis* and *prognosis*, and allows for the reception of *pronoia* from the daimon.

3.4 Heimarmenē and Pronoia: Third Appearance

Valens clearly believes in the power of providence; he just as clearly believes in *heimarmenē*. As far as his own life is concerned, providence as divine intervention provides a loophole that could allow him to wriggle out of some of the bonds of fate (the daimon being one instrument in this wriggling).

We can see the impact of *pronoia* and *heimarmenē* on Valens' practise of astrology. For *pronoia*, the following passage provides some insight:

The 3rd or 9th place from the Hour-marker handing or taking over when benefics are in them brings about living abroad for good. . . . Thus some in these places are given revelations by god and will have foreknowledge of the future, and they set up expiatory sacrifices, or prayers, or votive offerings to god; but others, escaping weakness, imprisonment, blame, suffering or danger give thanks to god because of his providence.⁸⁴

Astrological configurations, then, bestow divine aid in the form of *prognosis* and *pronoia*.

But the natal chart, for Valens, is also *heimarmenē*, providing in astrological language the outline of a human's lot in life which cannot be changed and is dependent on provision by his daimon. In the third appearance of *daimonion*, he says, in Book IX, 12.19:

. . . I myself, having learned about myself from foreknowledge (*prognōsis*), claimed such a foundational chart as my lot, and that within this parameter

83 See Komorowska, *Valens*, 281–334, Part 4, 8, which discusses not only Valens' philosophical eclecticism but also how deterministic he really is.

84 IV, 15.1–2 (Pingree, 174.7–8, 10–14): 'Ο γ' ἢ ὁ θ' τόπος ἀπὸ ὠροσκόπου παραδιδοῦς ἢ παραλαμβάνων, ἀγαθοποιῶν ἐπόντων, ξενιτείας ἐπ' ἀγαθῷ ἀποτελεῖ. . . . τινὲς μὲν οὖν ἐν τούτοις τοῖς τόποις χρηματίζονται ἀπὸ θεοῦ καὶ τὰ μέλλοντα προγινώσκουσι καὶ θεῷ ἐκθυσίας ἢ εὐχὰς ἢ ἀναθήματα κατασκευάζουσιν, τινὲς δὲ καὶ διὰ θεοῦ πρόνοιαν ἀσθένηαν ἢ συνοχὴν ἢ αἰτίαν ἢ πάθος ἢ κίνδυνον [οἱ] ἐκφυγόντες θεῷ εὐχαριστοῦσιν. This sort of apotropaic ritual/prayer as a result of astral omina/astrology echoes Egyptian or Babylonian practice: see Chapter 3.

it is not possible to become something different, and I became a lover neither of authority, rule, nor another kind of showy reputation or abundance of wealth and a mass of possessions or slaves, or a slave of desire and an impious flatterer of both gods and men, able to obtain what the *daimonion* did not wish to provide. . . .⁸⁵

He continues by comparing himself to a slave who, knowing by his intelligence the habits of a bad master, can make his service ‘without pain and tireless’ by not going against what has been ordered for him, and can ‘carefully keep the law of *heimarmenē*.’⁸⁶ The foreknowledge he possesses from astrology leads him to obtain all knowledge of his life that is possible for humans to obtain, which we could call a foreknowledge capable of leading to a *pronoia* given by the daimon. In this way astrology works with *heimarmenē* (and acknowledges the power of the daimon).

3.5 *Choosing the Right Moment: Fourth Appearance*

Other passages in Valens show relationships between the daimon, fate, astrology, knowledge and ‘right moments’. These ‘right moments’ concern katarchic astrology; Valens clearly believes that if it is not the right moment (for which we might use the word *kairos*) for things to happen, they will not—and nothing can be done about it, including prayer to the gods. In v, 2 he recounts the perils of beginning something when the arrangement of the heavens is not propitious—the result of such a *katarchē*⁸⁷ is punishment and delay—and because of this he realises that it is only at the opportune moments (*kairoi*) that events can come about easily.

85 Valens, IX, 12.19 (Pingree, 340.22–27): . . . και αὐτὸς καταμαθὼν ἑμαυτὸν ἐκ τῆς προγνώσεως και ὁποῖαν καταβολὴν ἔλαχον τοῦ κλήρου και ὅτι παρὰ τοῦτο ἀδύνατον γενέσθαι ἕτερον οὔτε ἡγεμονίας οὔτε ἀρχῆς οὔτε ἐτέρας φαντασιώδους δόξης ἢ πλοῦτου διαφιλείας και κτημάτων ἢ σωμαίων πλήθους ἐραστής ἐγενόμην ἢ δούλος ἐπιθυμίας και κόλαξ ἀσεβῆς θεῶν τε και ἀνθρώπων, δυνάμενος τυχεῖν ὧν μὴ ἐβούλετο τὸ δαιμόνιον παρέχειν. . . . The word Valens uses for the birthchart, καταβολή, is also used in v, 6.2, (209.1); v, 6.10 (210.6–7); and v, 6.20 (211.22) as a synonym for the nativity as one’s foundation. The same connotation is meant here. The idea of allotment is again stressed in ἔλαχον τοῦ κλήρου.

86 Valens, IX, 12.19 (Pingree, 340.27–33): . . . ἀλλὰ καθάπερ δεσπότου φαύλου <ὁ> ἐν συνέσει δούλος ἐπίσταται ἦθῃ και τὰς περὶ τὸν βίον ἀναστροφὰς κοσμίας τὰς ἐξυπηρετήσεις ποιοῦμενος και τῆ τοῦ κελεύοντος διαταγῇ μὴ ἀντιτασσόμενος ἀλύπητον και ἀκοπίατον ἡγείται τὴν ὑπόστασιν, τὸν αὐτὸν τρόπον και αὐτὸς οὔτε μοχθηρὰν οὔτε ἐπάδυνον τὴν ὑπηρεσίαν ἐποίησάμην, πάσης δὲ ματαίας ἐλπίδος και φροντίδος ἀπαλλαγείς τὸν τῆς εἰμαρμένης νόμον διεφύλαξα. (This is the entire sentence from which the quotations are excerpted.)

87 That is, the astrological time of beginning something.

And I myself, since I keep a watch out for such days according to what is possible, and make my *katarchai* for actions or friends according to the time-description of the opportune moments (*kairoi*), used to think of the *katarchē* as unchangeable and easily brought to completion; but when I was wandering and, through the untimely (*akairos*) presence or alliance of a friend, or by necessity, I made a beginning of something, I received a result that was liable to punishment and painful or causing delay. Whence for every *katarchē* one must observe carefully, in putting out a fleet and military command. . . . Truly, it is useless to sacrifice to god or to consecrate offerings; for prayers will not be answered and god will not let himself be worshipped, but he will be called upon idly and ineffectively.⁸⁸

Thus *kairos* and *katarchē* must be synchronised, and gods called on at the proper time. We can pick the *katarchē*, but *kairos* is out of our control. This is our *heimarmenē*, including even the little mundane things in our lives, and it is useless to think otherwise, Valens seems to say. The last appearance of the *daimonion* comes at IX, 12.31, and it is entwined with fate and choosing the favourable moment (here called καλή ὥρα):

But conversely I myself say against these claims [of what is in our power] that these vain things do not rest with them. For it turns out in the opposite way from the chosen plan through certain implacable causes. For many times when I, wishing to do something or to meet a friend, having selected a favourable time (καλή ὥρα), did not obtain what was proposed, and indeed I did not go where I intended to; but when I was not wishing for it, such a thing came to pass. For assuredly it was necessary for the time to happen to be (τυχεῖν) in harmony with that which is about to be. For that very reason those who possess intelligence (νοῦν ἔχοντας)⁸⁹ must follow the *daimonion* as it wishes (for it provides the idea for what

88 Valens, v, 2.22, 23 (Pingree, 202.17–23, 25–27): καὶ αὐτὸς μὲν οὖν τὰς τοιαύτας ἡμέρας φυλαττόμενος κατὰ τὸ δυνατόν καὶ ποιοῦμενος τὰς καταρχὰς τῶν πράξεων ἢ τῶν φιλιῶν κατὰ τὴν τῶν καιρῶν χρονογραφίαν ἀμετανόητον ἡγούμην τὴν καταρχὴν καὶ εὐσυντέλεστον, ἔσθ' ὅτε δ' ἐπλανήθην καὶ διὰ φίλου ἄκαιρον παρουσίαν ἢ σύστασιν ἢ μετὰ ἀνάγκης καταρξάμενός τινος ἐπιζήμιον καὶ ἐπίλυπον ἢ ὑπερθετικὴν ἔκβασιν καταλαβόμεν. ὅθεν ἐπὶ πάσης καταρχῆς παρατηρητέον, ἐπὶ τε τῆς τῶν στόλων ἀναγωγῆς καὶ στρατοπεδαρχίας. . . . οὐδὲ μὴν τῷ θεῷ θύειν καὶ ἱερά καθιδρύειν χρήσιμον· οὔτε γὰρ εὐχαὶ συντελεσθήσονται οὔτε θεὸς θρησκευθήσεται, ἀλλ' ὡς ἀργὸν καὶ ἄπρακτον διαφημισθήσεται.

89 One wonders if this common idiom was chosen by Valens deliberately to be understood in a sense akin to Plutarch's idea of the *nous/daimon* in *De genio* 591f (see above, 1.3, 25).

it will)⁹⁰ or select favourable times, and since the *katarchē* comes to determine an action in conformity with the cosmic movement, it is necessary to see the outcome [of the action] concurrently from the position of the stars and Hour-marker at that [beginning] time.⁹¹

I think Valens is saying here that, even though we think we are in control of the most mundane and petty things (like leaving the house and going to meet a friend), this is not really the case, for everything we actually do must align with the cosmic movement of the stars. If we do have the idea to meet a friend, and that comes to pass, it is because our idea was 1) suggested by the *daimonion* and 2) the time we pick is in alignment with the cosmos.⁹² Thinking that we have control is an illusion. There are ‘implacable causes’ at work: this is the law of *heimarmenē*. Even Valens cannot control whether his favourable time will synchronise with the desired event, nor can he summon the daimon or *pronoia* at will. Yet by choosing to follow the daimon in concert with choosing a moment aligned with the right cosmic movement, Valens privileges the

90 Note the similarity here with Galen’s daimon, as a spirit which commands what it wants the human to do.

91 Valens, IX, 12.28–31 (Pingree, 341.25–342.3): τὸν ἀντίον δ’ ἐγὼ φημι πρὸς τούτους ὅτι οὐδὲ ταῦτα τὰ μάταια ἐν αὐτοῖς ἔστιν· εἰς τὸ ἐναντίον γὰρ χωρεῖ τὸ τῆς προαιρέσεως διὰ τινὰς ἀπροφασίστους αἰτίας. καὶ γὰρ αὐτὸς πολλάκις πράξει τι βουλόμενος ἢ συντυχεῖν φίλῳ ὥραν καλὴν ἐκλεξάμενος οὐκ ἔτυχον τοῦ προκειμένου, οὐδὲ μὴν ὅπου ἐβάδιζον ἐγένετο· ὅποτε δ’ οὐκ ἐβουλήθη, τὸ τοιοῦτον συνετελέσθη. πάντως γὰρ ἔδει τὴν ὥραν ἐναρμόνιον τῷ μέλλοντι ἔσεσθαι τυχεῖν. τοιγαροῦν χρὴ τοὺς γε νοῦν ἔχοντας ἔπεσθαι τῷ δαιμονίῳ καθὼς βούλεται (κατασκευάζει γὰρ τὴν <ἐννοίαν> πρὸς ὃ θέλει) ἢ καλὰς ὥρας ἐκλέγεσθαι, ἀρχικῆς δὲ πράξεως τῆς καταρχῆς γενομένης κατὰ τὴν κοσμικὴν κίνησιν [καὶ] ἀνάγκη συνορᾶν τὸ ἀποτέλεσμα ἐκ τῆς τότε ἀστροθεσίας καὶ τῆς τοῦ ὥροσκόπου. Many thanks to Stephan Heilen for helpful suggestions in translating the last part of this passage (‘ἀρχικῆς... ὥροσκόπου’). In addition to other advice, he pointed out that the first καὶ in this part is probably spurious, a (typical) solution for the Byzantine scribe of ms. S (cod. Oxon. Selden 22) to fix a corruption of the original ἀνάγκη to ἀνάγκην (for more on this condition and additional examples, see S. Heilen, *Hadriani genitura. Die astrologischen Fragmente des Antigonos von Nikaia. Edition, Übersetzung und Kommentar* (Berlin: De Gruyter, in press)).

92 It seems that Valens is in general agreement with the *On Fate* essayist, but differs with him in the possibility of humans as their own agents operating as part of *heimarmenē*. For Valens, it seems, only the heavens in their ‘cosmic movement’ and the *daimonion* can be agents. A similar sentiment is expressed in Manilius, 4.107–117: see W. Theiler, ‘Tacitus und die antike Schicksalslehre’, in *Forschungen zum Neuplatonismus, Quellen und Studien zur Geschichte der Philosophie* (Berlin: Walter de Gruyter, 1966), 46–103, here 68; and P. L. Donini, *Tre studi sull’aristotelismo nel II secolo d. C.* (Turin: Paravia, 1974), 146–47 and n. 35 (thanks to Robert Sharples for these references).

importance of both the daimon and astrology in living life in harmony with the universe.

But providence, in the system of *De fato*, is not subject to *heimarmenē*. Humans can come to know a *part* of providence, especially through the study of the stars, and also through the daimon. It is the combination of knowing this part of providence and finding the peace that comes from knowing that makes life bearable, ‘without pain and tireless’. It is through the workings of providence (via the daimon) that Valens has some of the most transcendent and ecstatic moments in his life.

For I have not made the words for the uninitiated,⁹³ but for the ones clever at such things as they follow with acuity the manifold and intricate [part] of the theory through many ways, both ins and outs, in learning to know [these things], they will seem to associate with gods.⁹⁴

And like the gods, may acquire a measure of *pronoia*.

Valens tells us his astrological wisdom was the result of *pronoia*, that he was ‘thought fit by God and providence’ to be given such understanding (IX, 1.10). He then says:

For all that men have obtained as their lot is not [only] perishable and wretched, but also some divine piece of work in us that is God-inspired; indeed such imperishable air being poured round us, actually being and extending into us, imparts a timely effluence (*aporroia kairikē*) of immortality in ordered and measured time (*chronos*), an effluence which each of us, every day, is accustomed when exercising to take in and then give out as the vital breath.⁹⁵

This ‘divine piece of work’ is the soul, and with such a divine soul ‘we move, converse, achieve, construct and make godlike works.’⁹⁶ The practice and

93 Again, Valens conceives of astrology as a mystery into which one is initiated.

94 Valens, IX, 12.2 (Pingree, 338.25–28): οὐ γὰρ πρὸς ἀμυήτους ἐποησάμην τοὺς λόγους, ἀλλὰ πρὸς τοὺς τὰ τοιαῦτα δεινοὺς ὅπως καὶ αὐτοὶ τὸ πολυμερές καὶ ποικίλον καὶ ἀκμῆ ἔλλήγον τῆς θεωρίας διὰ πολλῶν ὁδῶν, εἰσὸδων τε καὶ ἐξόδων, ἐπιγρόντες θεοῖς προσομιλεῖν δόξωσιν.

95 Valens, IX, 1.11 (Pingree, 317.14–19): Οὐ γὰρ φθαρτὰ πάντα καὶ μοχθηρὰ ἔλαχον οἱ ἄνθρωποι, ἔστι δέ τι καὶ θεῖον ἐν ἡμῖν θεόπνευστον δημιουργημα· ὃ γε περιεχυμένος ἀήρ ἄφθαρτος ὑπάρχων καὶ διήκων εἰς ἡμᾶς ἀπόρροιαν καιρικὴν ἀθανασίας ἀπονέμει τακτῶ καὶ μεμετρημένῳ χρόνῳ, ἣν ἕκαστος ἡμῶν καθ’ ἡμέραν μελετᾷ γυμναζόμενος λαμβάνειν ἢ καὶ ἀποδιδόναι τὸ ζωτικὸν πνεῦμα.

96 IX, 1.16 (Pingree, 317.27–28): ἔνθεν ἐφ’ ὅσον ἔχομεν τὴν ψυχὴν κινούμεθα καὶ ὀμιλοῦμεν καὶ πράσσομεν καὶ μηχανώμεθα καὶ ποιοῦμεν ἔργα ἰσόθεα.

teaching of astrology would be a 'godlike work' for Valens: we know that he considers astrology to be 'holy' and 'handed over to humans by god, so that they may possess a portion of immortality through prognosis . . .'⁹⁷

This soul, in Valens' view, is linked to an immortal air which has both 'kairical' and chronical components. Let us give some thought to *kairos* and *chronos* in this context. First, *kairos* is connected with the divine and the immortal. Second, *kairos* seems to be above *chronos*, or at any rate to regulate it. In the same way, primary providence is above secondary and tertiary providence in *De fato*. Can time (*chronos* or *kairos*) and providence be related? In Plutarch's *Platonic Questions*, he posits, reading *Timaeus*, a *pronoia* which creates *chronos*.⁹⁸ If, based on this, we can posit that primary *pronoia* is kairical (a not completely far-fetched leap, in my view), then secondary *pronoia*, representing astrology via the gods in heaven and their movements; and tertiary *pronoia*, the province of the daimon, would represent a chronical *pronoia*. Tertiary, chronical *pronoia* is provided to humans by the daimon. This would be the *pronoia* Valens is talking about. The tertiary *pronoia* that humans are able to know is a chronical *pronoia*, but theoretically it can be superseded by this kairical *pronoia*.⁹⁹ And this is why interpretation in astrology sometimes fails: the astrologer can access only tertiary, chronical *pronoia*, and not kairical *pronoia* which lies above it; as Valens makes clear, we cannot control *kairos* (or a kairical *pronoia*). Yet this access to tertiary, chronical *pronoia* is also what allows an insightful and meaningful interpretation by the astrologer (insight, not foresight, may be a better translation of *pronoia* in this context).¹⁰⁰

97 v, 6.16 (Pingree, 210.30–32): ὅθεν ἢ μὲν ὑπόστασις τοῦ μαθήματος ἱερὰ καὶ σεβάσιμος ὡς ὑπὸ θεοῦ παραδεδομένη τοῖς ἀνθρώποις, ὅπως καὶ αὐτοὶ μέρος ἀθανασίας διὰ τῆς προγνώσεως ἔχωσιν. . . .

98 Plutarch, *Platonic Questions* 1007c: . . . ἐφελκύσασα δὲ πρόνοια καὶ καταλαβούσα τὴν μὲν ὕλην σχήμασι τὴν δὲ κίνησιν περιόδοις τὴν μὲν κόσμον ἅμα τὴν δὲ χρόνον ἐποίησεν. ' . . . but providence, when she took in tow and curbed matter with shapes and motion with revolutions, simultaneously made of the former a universe and of the latter time.' (trans. Harold Cherniss, in *Moralia*, XIII, Part 1, 86–89).

99 For god linked to *kairos*, see Plutarch, *De sera numinis vindicta*, trans. Phillip H. De Lacy and Benedict Einarson, in *Moralia*, VII (Cambridge, MA: Harvard University Press, 1959, repr. 2000), 190–91, 550a: . . . ὅτι τὸν καιρὸν εἰδὼς ἄριστα τῆς περὶ τὴν κακίαν ἰατρείας. . . . ' . . . that he [God] knows full well the right moment for healing vice . . .'. Also see Aristotle, *Prior Analytics* 1.36, 48b36 (Ross): . . . θεῷ γὰρ καιρὸς μὲν ἐστὶ . . . ' . . . *kairos* belongs to god . . .'; and Plato, *Laws* 709b (Burnet): ὡς θεὸς μὲν πάντα, καὶ μετὰ θεοῦ τύχη καὶ καιρὸς, τὰνθρώπινα διακυβερνῶσι σύμπαντα. 'As God controls all things, and with god, fortune and opportunity control all human affairs.'

100 Thanks to Joseph Crane for suggesting this meaning for *pronoia*.

The daimon and tertiary providence enable and aid interpretation of the astrological patterns—and it is the interpretation (which, after all, is a function of the daimon) which uncovers the meaning of the heavenly pattern (symbolised by secondary providence)—which makes a heavenly pattern accessible.

The way (for Valens and any astrologer) to come to prognosis is by studying the movements of the stars, for they are the embodiment and ensoulment of both *heimarmenē* and *pronoia*. This is not astrology as frivolous and idle prediction, but as a discipline for obtaining gnosis, and therefore aligning with the divine. If we try to see the alignments and patterns between the stars and the events in our lives, we can see more of the divine plan that has been written for us, a plan that can be divulged by the daimon at the level at which we are able to comprehend it. Our daimon is our link to the divine and to divination—Plutarch says the daimons are in charge of the oracles, and they are also in charge of human souls. In the story of Zeus and Semele, the sight of the god is too much for mortal eyes—but the daimon's is a gentler light that can be borne by humans. Through the daimon, we can process the light of both the sun and the moon—the sun representing *nous* and its place in the soul, and the moon representing the body which holds the soul in our human incarnation. The daimon partakes of both, and in astrology we can see this combination in the Lots of Fortune and Daimon and the points which form them: Sun, Moon and Hour-marker (Ascendant),¹⁰¹ our point of personal incarnation, the point of our appearance on earth.

101 Do these mirror Valens' fate, daimon and propitious time? Thanks to Micah Ross for this observation.

Keeping in Good Spirits: The Places of Good Daimon and Fortune in Astrology

The departure of the good Daemon

What can I do in Poetry,
Now the good Spirit's gone from me?
Why, nothing now but lonely sit
And over-read what I have writ.

ROBERT HERRICK¹

Tyche and Daimon are commonly paired in the Hellenistic and Greco-Roman eras. Astrology follows this propensity, literally connecting fortune and daimon in its mechanics, and often in its practices, as we saw in the Introduction. Chapter One initiated the discussion of how astrology connects fortune and daimon in the use of lots, and implicated daimon and fortune (as chance) in the workings of Greek fate. This chapter introduces essential cultural links and significations between Good Fortune (Agathe Tyche) and Good Daimon (Agathos Daimon). It will then examine the use of good fortune and daimon in the astrological places.

We begin with a short introduction to the importance of Tyche and Daimon in Hellenistic Egyptian and Greco-Roman cultures. This précis will serve to establish the significance and relationship of these two concepts both religiously and philosophically. They will then be explored, primarily in an astrological context, through the rest of the chapter, and in greater detail in Chapter Three.

Ultimately, this chapter has two purposes in examining Daimon and Tyche as a pair. The first is to establish the parameters and signification of the link between Daimon and Fortune. The second is to explore the uses of the *Agathos Daimōn* and *Agathē Tuchē* in the astrological places. Both the eleventh place (called Good Daimon) and the fifth (Good Fortune), which are connected in many respects, will be considered. In addition, by exploring the cultural Agathos Daimon in a (mostly) Greek milieu, we set the stage for its transfer into Egypt after Alexander, and the crucial connections between the Greek and Egyptian guises of the Agathos Daimon. Throughout the chapter, the enduring

¹ In R. Herrick, *The Poetical Works of Robert Herrick* (Oxford: Clarendon Press, 1956).

and inextricable link between the Agathos Daimon and Agathe Tyche underscores its significance in both the theory and the practice of Hellenistic astrology.

1 Why Tyche and Daimon? Some Cultural and Historical Background

One of the answers to this question lies in the culture of Alexandria, where the cults of Fortune and Daimon were well developed by the second century CE. There were not only cults to the general deities Agathe Tyche and Agathos Daimon, but the concept of one's personal *tuchē* and *daimōn* also had some currency.² In the Hellenistic period in Alexandria, the Agathos Daimon and Agathe Tyche become linked to Sarapis and Isis, as well as to the strictly Egyptian deities Shai (god of 'fate') and Renenet (goddess of nourishment). However, other cultural roots for the Agathos Daimon and Agathe Tyche lie in Greece.³

In books like Plutarch's *Parallel Lives* the underlying theme shows the good or bad fortune given to each of the biographical subjects, as well as the connection with either a good or bad, a strong or weak, daimon.⁴ There is evidence of a personal Agathos Daimon for 'ordinary' people beginning around the fourth or third century BCE. For example, one Posidonius of Halicarnassus, who consulted an oracle of Apollo at Telmessus, was told that he should pay homage to 'the Agathos Daimon of Posidonius and Gorgis' (his own and his wife's daimon).⁵

Both Fortune (Tyche) and Daimon are, from the Hellenistic period into Late Antiquity, given great power in the determination of human fate. Cults of Agathe Tyche and Agathos Daimon arose to propitiate these deities as early as the fourth century BCE, and they were still flourishing when the Hellenistic form of astrology came to prominence. (In Roman Egypt, children were even

² See P. M. Fraser, *Ptolemaic Alexandria*, 3 vols (Oxford: Clarendon Press, 1972), here I, 241–43.

³ For an account of the Agathos Daimon in Greece and Alexandria, see D. Ogden, *Drakōn: Dragon Myth and Serpent Cult in the Greek and Roman Worlds* (Oxford: Oxford University Press, 2013), 271–309. This resource is helpful for all things god, snake and serpent related in the ancient Mediterranean world.

⁴ For discussion of *daimōn* and *tuchē* in the *Lives*, see Brenk, *In Mist Apparelled*, 148–54, 159–83.

⁵ G. Sfameni Gasparro, 'Daimōn and Tuchē in the Hellenistic Religious Experience', in *Conventional Values of the Hellenistic Greeks*, ed. Per Bilde, et al. (Aarhus: Aarhus University Press, 1997), 89 and nn. 172–173.

named ‘Agathos Daimon’.)⁶ Pliny laments the ubiquity of Fortune in world opinion, and even explicitly calls her the ‘lot’ (*sors*) which ‘takes the place of god’.⁷ Polybius mentions Tyche as a potent force in the rise and fall of nations.⁸

In such a climate it is not hard to detect astrology’s assimilation of the cultural importance of Fortune and the Daimon into its theory and practice—after all, the interpretation of the astrological chart is supposed to reveal just such fortunes for its ‘natives’. While the astrological Lots of Fortune and Daimon are one way to look at the personal effects of Fortune and Daimon on an individual, the pair are also manifestly incorporated in the names of the astrological places: the fifth and sixth are Good Fortune and Bad Fortune, and the eleventh and twelfth Good Daimon and Bad Daimon.

1.1 *Pairing Tyche and Daimon*

The way we see Good Fortune and Good Daimon paired in astrology is a manifest example of their pairing in the general culture of the time. Thus, when we cover the place of the Good Daimon in astrology in this chapter, we cannot divorce it from its counterpart place of Good Fortune. Other cultural and literary examples of Agathe Tyche and Agathos Daimon as a binary unit will serve as a demonstration of the significance of this pairing.⁹

The same Posidonius and Gorgis described above who had their own Agathos Daimon also were bidden to perform rituals honouring his parents’ Agathe Tyche.¹⁰ Both epigraphical inscriptions and reliefs of the paired Agathos Daimon and Agathe Tyche exist throughout the Mediterranean area, including one on the Acropolis dated ca. 360 BCE.¹¹

6 Fraser, *Ptolemaic Alexandria*, 1, 209 (but see also 209–11 for Daimon and Tyche in this period). See PGM xv.1–21, which is a spell for binding ‘Nilos, who is also [called] Agathos Daimon’ to Capitolina: H. D. Betz, ed., *The Greek Magical Papyri in Translation, including the Demotic Spells*, vol. 1, *Texts* (Chicago/London: University of Chicago Press, 1986, 2nd ed. 1992, repr. 1996), 251.

7 Pliny, *HN*, 11, 5.22–26. ‘... toto quippe mundo et omnibus locis omnibusque horis omnium vocibus Fortuna sola invocatur ac nominatur...’ (5.22); ‘... ut sors ipsa pro deo sit, qua deus probatur incertus’ (5.23).

8 For Fortune in Polybius, see P. Shorey, ‘Τύχη in Polybius’, *CPh* 16, no. 3 (1921): 280–83.

9 For paired deities relating to Agathos Daimon and Agathe Tyche, with abundant examples and bibliography, see C. E. Barrett, *Egyptianizing Figurines from Delos: A Study in Hellenistic Religion* (Leiden/Boston: Brill, 2011), 221–27. For male-female anguiform pairs, see Ogden, *Drakōn*, 277–78.

10 Sfameni Gasparro, ‘*Daimōn* and *Tuchē*’, 89–90.

11 A. Kosmopoulou, *The Iconography of Sculptured Statue Bases in the Archaic and Classical Periods* (Madison, WI: University of Wisconsin Press, 2002), fig. 45; 71–72, 189–90;

In Plato's *Laws*, Tyche and Daimon together are represented as responsible for a man's life—Tyche is the bad fortune under which he tries to kill someone, and Daimon the guardian who keeps the wound from being fatal (for which, Plato says, he should be banished, not executed).¹² (In astrology, the Lots of Fortune and Daimon when afflicted are associated with violent death and banishment.)¹³ By the second century CE, essays on fate consider the power of both Tyche and Daimon.¹⁴ In the *Tabula Cebetis*, which may be earlier but was popular in the second century, Daimon guides the entry into life, which contains a Tyche who gives and takes away fortune for those entering.¹⁵ The Lots of Fortune and Daimon, which are the most important lots in astrological

F. Dunand, 'Agathodaimon', in *LIMC*, vol. 1/1 (Zurich/Munich: Artemis Verlag, 1981), 278 no. 4; E. Mitropoulou, *Deities and Heroes in the Form of Snakes* (Athens: Pyli Editions, 1977), 159–60 and fig. 79; Ogden, *Drakōn*, 302, mentions two other reliefs of similar date and content. See also Sfameni Gasparro, 'Daimōn and Tuchē', 80–82, 89 for other inscriptions and reliefs. For Agathos Daimon and Agathe Tyche cults on Delos, see Barrett, *Egyptianizing Figurines*, 244–46.

- 12 Plato, *Laws*, 876e4–877b2: 'So let the written statute on wounding be set as follows: if anyone wishes intentionally to kill a friendly person—except whom the law sends him against—[and] wounds, but is unable, to kill him, he who thus intended and inflicted the wound is not worthy of pity, nor respected in any other way than as a murderer who must suffer the penalty for murder. Yet out of respect for the not wholly bad fortune which came to him, and the Daimon who, in pity for him and the wounded man, kept the wound of the one from being fatal and the fortune and offence of the other from being accursed, in gratitude to the Daimon for this and not opposing it, to cancel the death penalty of the wounder, and remove him to a neighbouring city for the rest of his life, enjoying the fruits of all his own possessions.' (Burnet, vol. 5): ἡ δὴ γραφή περὶ τραύματος ὧδε ἡμῖν κείσθω. Ἐάν τις διανοηθεὶς τῇ βουλῆσει κτείνει τινα φίλιον, πλὴν ὧν ὁ νόμος ἐφήρισιν, τρώσῃ μὲν, ἀποκτείνει δὲ ἀδυνατήσῃ, τὸν διανοηθέντα τε καὶ τρώσαντα οὕτως οὐκ ἄξιον (877a) ἐλεεῖν, οὐδὲ αἰδούμενον ἄλλως ἢ καθάπερ ἀποκτείναντα ὑπέχειν τὴν δίκην φόνου ἀναγκάζειν· τὴν δὲ οὐ παντάπασιν κακὴν τύχην αὐτοῦ σεβόμενον καὶ τὸν δαίμονα, ὃς αὐτὸν καὶ τὸν τρωθέντα ἐλεήσας ἀπότροπος αὐτοῖς ἐγένετο μὴ τῷ μὲν ἀνάτατον ἔλκος γενέσθαι, τῷ δὲ ἐπάρατον τύχην καὶ συμφορὰν, τούτῳ δὲ χάριν τῷ δαίμονι διδόντα καὶ μὴ ἐναντιούμενον, τὸν μὲν θάνατον ἀφελεῖν τοῦ τρώσαντος, μετὰστασιν (877b) δὲ εἰς τὴν γείτονα πόλιν αὐτῷ γίγνεσθαι διὰ βίου, καρπούμενον ἅπασαν τὴν αὐτοῦ κτήσιν.
- 13 See, e.g., *CCAG* VIII/4, 121.3–11, in Rhetorius's fifth consideration on the lots (see Appendix 8.C).
- 14 As we have seen with Pseudo-Plutarch, *De fato*; also Maximus of Tyre, *Orations*, esp. 5, 8, 9, 13; Apuleius, *De deo Socratis*, *De Platone*; Alexander of Aphrodisias, *On Fate*.
- 15 See *The Tabula of Cebes*, trans. John T. Fitzgerald and L. Michael White (Chico, CA: Scholars Press, 1983). A number of motifs in this work may have other astrological implications, in addition to its obvious Platonic correspondence. See also commentary and bibliography on the *Tabula*, M. B. Trapp, 'On the Tablet of Cebes', in *Aristotle and After*, *BICS Supplement* 68 (1997), 159–80.

interpretation and prediction, thus may be particularly capable of delineating the fate (and the providence) which is endowed to their recipients, but the places of Good Fortune and Good Daimon provide areas where the capacities and results of these endowments may be seen. It is to these that we now turn.

2 The Astrological Places of Good Daimon and Good Fortune

What do astrologers say about the Agathos Daimon, via its incorporation into the system of astrological places? It names the eleventh place, opposite the fifth place of Good Fortune. Bouché-Leclercq remarked that, given the importance of Fortune, both universal and individual, in the Greco-Roman world, it was not surprising that astrologers allotted places in the chart to delineate personal fortune.¹⁶ Given the association of daimon with fortune, and the increasing significance of both a personal and *polis* Daimon, it is, then, not surprising that the place in the chart opposite that of Good Fortune should be allotted to the Good Daimon. Clearly the power of a benevolent daimon to improve the life of its corresponding human being was not taken lightly. Indeed, one could argue that the location of the Good Daimon in the upper hemisphere of the chart, climbing towards the Midheaven, shows its superiority to Good Fortune (which is in the lower hemisphere and moving down to the IC). The associations between Moon/Fortune and Sun/Daimon are also accounted for in this scheme. The Fortune/*Tuchē* places (both good and bad) are located below the horizon, the province of the night and the Moon. The Daimon places (again, good and bad) are located above the horizon, the province of the day and the Sun.

The two benefic planets, Venus and Jupiter, were respectively assigned to the places where Good Fortune and Good Daimon resided. This too indicates Daimon's superiority over Fortune, as Jupiter is the greater benefic and Venus the lesser benefic. Venus (Aphrodite) has associations with Tyche and Fortuna,¹⁷ and Jupiter (Zeus) with Agathos Daimon (the Agathos

16 Bouché-Leclercq, *AG*, 288–89: 'Chaque individu avait donc sa Fortune, et une place d'honneur devait être réservée dans le cercle de la géniture à ce Génie féminin.'

17 E.g. in Plutarch, *De fortuna Romanorum*, 317f–318d, where Sulla's embrace of Fortuna is linked to Aphrodite; Pausanias, *Description of Greece*, I, 43.6, where statues of Aphrodite and Tyche are placed near each other at Megara. See also D. A. Arya, 'The Goddess Fortuna in Imperial Rome: Cult, Art, Text' (Ph.D. Thesis, University of Texas at Austin, 2002), 187–89; Brenk, *In Mist Apparelled*, 171, n. 25.

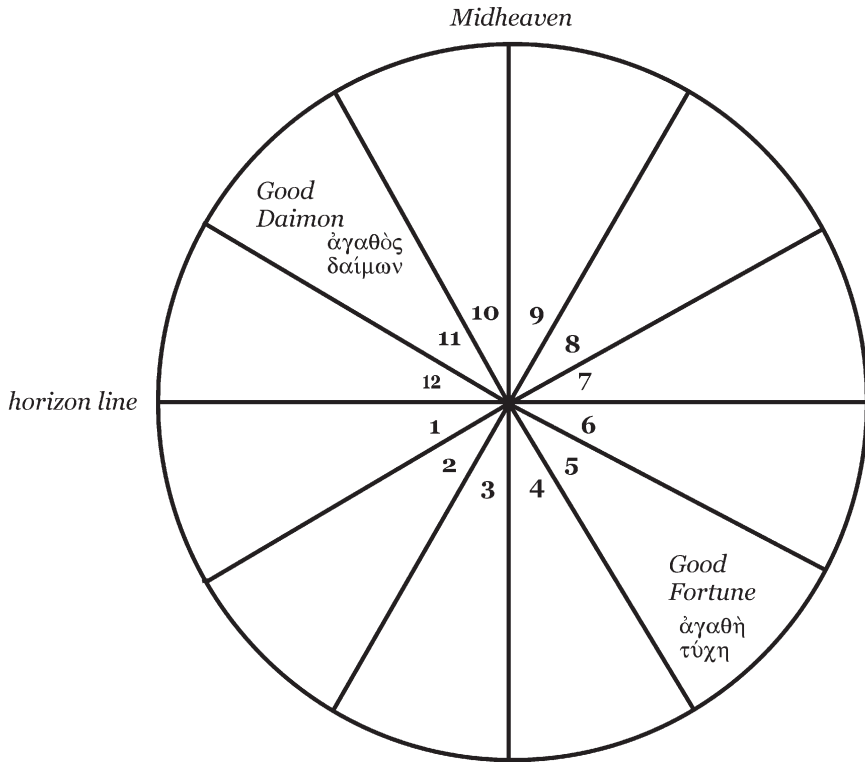

FIGURE 2.1 *The eleventh and fifth places.*

Daimon is even pictured in Hellenic iconography as a man with a beard, similar to the way Zeus is often portrayed).¹⁸

The characteristics of the fifth and eleventh places derive from cultural factors and in this vein, some background material from both a Greek and an Egyptian perspective is germane here.

2.1 *Zeus Ktesios and the Eleventh Place*

The attributes and powers of Zeus in various aspects are relevant to the significations of the eleventh place. One of these, Zeus Ktesios—Zeus as a protector

18 For connections between the Greek Agathos Daimon and Zeus, see J. E. Harrison, *Themis: A Study of the Social Origins of Greek Religion* (Cleveland/New York: World Publishing Company, 1927, repr. 1962), 283–86; Ogden, *Drakōn*, 284–85. The iconography of Zeus in various aspects and Agathos Daimon can be so similar that scholars have found it difficult to differentiate between the two: see, e.g. C. M. Edwards, ‘Tyche at Corinth’, *Hesperia* 59, no. 3 (1990): 529–42, here 539–41.

of one's house and property, and of acquisition¹⁹—is well attested in Classical Greece and persisted into Roman times.²⁰ A relief of the third century BCE depicts him as a snake²¹ and, from the Hellenistic period, at least, the Agathos Daimon also has persistent ophitic connections²² (see his Egyptian links in Chapter 3, 1.1–1.2). In addition, Zeus Ktesios has strong ties to Zeus Meilichios and Zeus Philios,²³ aspects of Zeus with specific links to Agathe Tyche.²⁴ Daimon is Zeus Meilichios in Orphic Hymn 73.2 (see Appendix 10.A). But most valuable for our purposes are Zeus Ktesios's associations with property and acquisition, important attributes of the eleventh place. As a god of the house and its protection, Zeus Ktesios was propitiated to increase the contents of the storeroom²⁵ as well as the health and good prosperity of the family.²⁶ (In the first century CE, the Agathos Daimon is seen as preserving household goods and the fruits of the harvest.²⁷) Valens calls the eleventh place from the Lot of Fortune a 'place of acquisition' (11, 21.1). Thus elements of Zeus Ktesios and his cohorts match the attributes of the eleventh place, the place where Jupiter has its joy, and even subsequently derived 'eleventh' places (see below, 2.5).

-
- 19 'κτήσιος' as adjective from κτήσις, 'acquisition' (see LSJ, s.v. κτήσιος and κτήσις). The relationship between Zeus Ktesios and the Agathos Daimon which prompted this section is discussed in Ogden, *Drakōn*, 283–85. His bibliography has been helpful here.
- 20 Harrison, *Themis*, 298–303; M. P. Nilsson, *Greek Popular Religion* (New York: Columbia University Press, 1940), 67–68.
- 21 See M. Nilsson, 'Schlangenstele des Zeus Ktesios', *Athenische Mitteilungen* 33 (1908): 279–88; Harrison, *Themis*, 297 and fig. 79; Ogden, *Drakōn*, 283, 285, 302.
- 22 See Barrett, *Egyptianizing Figurines*, 227–32.
- 23 Nilsson, 'Schlangenstele', 286: '... weil diese drei Gottheiten [sc. Zeus Meilichios, Ktesios, Philios] gleich und im Grunde identisch waren...'. For wealth associated with Zeus Meilichios, see M. H. Jameson, D. R. Jordan, and R. D. Kotansky, *A Lex Sacra from Selinous* (Durham, NC: Duke University, 1993), 94–95 (citing Xenophon, *Anabasis*, 7.8.1–6), 97; for wealth, hope and grace linked to the Agathos Daimon, see Harrison, *Themis*, 296.
- 24 See Ogden, *Drakōn*, 284–85; Harrison, *Themis*, 298; Jameson, Jordan, and Kotansky, *Lex Sacra*, 97, n. 17; for votives to Zeus Meilichios and others including Agathos Daimon and Agathe Tyche, see G. V. Lalonde, *Horos Dios (HOPOΣ ΔΙΟΣ): An Athenian Shrine and Cult of Zeus* (Leiden/Boston: Brill, 2006), 114 and n. 40.
- 25 Harrison, *Themis*, 297–98. Orphic Hymn 73.4, 'To Daimon', calls on the Daimon as Zeus, a wealth-giver for the house (see Appendix 10.A).
- 26 Isaeus, an Attic orator of the early 4th cent. BCE, recounts the prayers of a certain Ciron for these benefits from Zeus Ktesios ('... και ηύχετο ἡμῖν ὑγίαιαν διδόναι και κτήσιν ἀγαθὴν...'): Isaeus 8.16; reference in Ogden, *Drakōn*, 283 and n. 66.
- 27 In Cornutus, *Theol. Graec.*, 27.4 (Lang, 51.11–52.3) he is equated with the cosmos, called (51.15) 'preserver of household things' (σωτήρ τῶν οἰκείων); the cornucopia is one of his attributes. (I owe this reference to Ogden, *Drakōn*, 299 n. 147.)

2.2 Demotic Astrological Places

Demotic astrology can provide some insight into the features of the eleventh and fifth places. The divinities Shai²⁸ (god of ‘fate’) and Shepset (goddess of nobility and wealth) give their names to the Egyptian eleventh and fifth places. This is significant because of their cultural links to Good Daimon and Good Fortune, as will be made clear in Chapter Three. For now, it is enough to know that Shai has to do with destiny and is often portrayed in snake form, and Shepset is associated with both procreation and material riches. Both divinities have protective qualities.

Certain allusions in O. HÖR 3 (second cent. BCE) seem particularly pertinent for the use of ššy and špšy.t in the astrological places. In this text, Isis is the major player in what seems to be a birthday celebration for Ptolemy VI Philometor. Isis is the one who ‘caused you to be born (on) <Thoth, day 12>’ (ll. 12–13 *recto*),²⁹ and gives Ptolemy ‘every good event’ (*shny-nfr nb*, l. 12 *recto*).³⁰ She opens the year (l. 5 *recto*) which is ‘favourable’ (*rnpt nfrt*, l. 3 *recto*), ‘favourable for your Shai and favourable for your Shepset’ (*nfr:s pšy.k ššy nš-nfr:s tšy.k špšy.t*, line 4 *recto*).³¹ The combination of a birth day and its anniversary (the king’s own ‘new year’), the prediction of good yearly events as well as good fate and fortune, and that Isis herself chose his birth day for its favourable conditions (*mdt-nfrw*, ‘benefits’, l. 14 *recto*)³² suggest, if not a strictly astrological,³³ at least a hemerological, component in predicting good outcomes for the king.

Demotic astrological texts call the fifth place (*tš*) špšy(.t) and the eleventh *pš šy*, the first corresponding to ἀγαθή τύχη in Greek, and the second to ἀγαθός δαίμων (see above, Fig. 2.1). There is some Demotic evidence of *tš* špšy.t as a benevolent divine protector, opposed to *tš* wry.t, characterised as an ‘evil

28 I use what seems to be a standard spelling for Shai, even though in Egyptian the name is most often spelt with the double reed-leaf, which represents a ‘y’ not an ‘i’.

29 See J. D. Ray, *The Archive of HÖR* (London: Egypt Exploration Society, 1976), 23 note *w*, 26 note *i*.

30 *Ibid.*, 21, 25 (translation slightly modified). For more on *shny-nfr* and its relationship to Shepset, see Chapter 3, 2.3, 102 and n. 118.

31 *Ibid.* I thank M. Ross for the transliteration. Note *nfr* as equivalent to Greek καλός here, reminiscent of Valens’ καλή ὥρα (IX, 12.29; Pingree, 341.28): see Chapter 1, 3.5, 41–42 and n. 91.

32 Ray, *Archive of HÖR*, 21, 25.

33 Some words used here appear in astrological contexts. In addition to ššy and špšy.t in tandem, *shny*, event or outcome, appears in P. Berlin 8345. *Mdt-nfrw*, benefits, is used in (the unpublished) PSI inv. D. 34 and P. Carlsberg 81 (*non vidi*): see A. Winkler, ‘Looking at the Future: Divination and Astrology in Ancient Egypt’ (Ph.D. Thesis, Uppsala University, 2011), 246–47.

demon'.³⁴ Several publications of Demotic astrological material refer to *tʃ špšy.t* and *pʃ šy* (or variants thereof).³⁵ Those of Spiegelberg, Thompson and Neugebauer describe a two-part ostrakon, called 'Ostrakon 3' by Neugebauer.³⁶ The last two lines of this ostrakon contain the words:

Line 22 ³⁷	<i>pʃ šy pʃ mʃy</i>	The Shai: Leo
Line 23 ³⁸	<i>pʃ sšr tʃ ꞥꞥ</i>	The Evil Spirit: Virgo

The determinatives following *šy* include either the king with flagellum (A42 in Gardiner's Sign List) or the shepherd (A47), used in 'protection' words. The word for 'Evil Spirit' (*pʃ sšr*) is the slaughtering demon, as found in the story of Setne Khaemwas II.³⁹ This ostrakon places the zodiacal sign of Leo in the eleventh place, and Virgo in the twelfth.

Another ostrakon also contains references to *šy* and *špšy* (called 'Ostrakon 5' by Neugebauer and 'H. T. 2' by Thompson).⁴⁰ The relevant lines read:

-
- 34 G. R. Hughes, 'A Demotic Plea to Thoth in the Library of G. Michaelides', *JEA* 54 (1968): 176–82, here 178–79. This is not an astrological text, however. The sixth astrological place is *ꞥwy wꞥy* in P. Berlin 8345, II, 1; IV, 15; see G. R. Hughes, 'An Astrologer's Handbook in Demotic Egyptian', in *Egyptological Studies in Honor of Richard A. Parker*, ed. Leonard H. Lesko (Hanover, NH: University Press of New England, 1986), 54–55.
- 35 E.g., W. Spiegelberg, 'Die ägyptischen Namen und Zeichen der Tierkreisbilder in demotischer Schrift', *ZAS* 48 (1910): 146–51; H. Thompson, 'Demotic Horoscopes', *PSBA* 34 (1912): 227–33; O. Neugebauer, 'Demotic Horoscopes', *JAOS* 63, no. 2 (1943): 115–27; Hughes, 'Astrologer's Handbook', 53–69; J. F. Quack, 'Ein astrologisches Ostrakon der frühen Kaiserzeit (oGlasgow D 1925.96)', *Enchoria* 31 (2008–2009): 104–12. See J. Quaegebeur, *Le dieu égyptien Shai dans la religion et l'onomastique* (Leuven: Leuven University Press, 1975), 171 and n. 2 with references. The unpublished PSI inv. D. 34 (*non vidi*: see Winkler, 'Looking at the Future', 289) refers to Jupiter in the 'house of špš'.
- 36 The top collected by Thompson, the bottom a Strassburg ostrakon (now known as O. Stras. 1566) discussed by Spiegelberg; see Thompson, 'Demotic Horoscopes', 231–32; Spiegelberg, 'Namen und Zeichen', 149–50. Neugebauer, 'Demotic Horoscopes', 116–18, discusses both parts, which fit together.
- 37 Line 8 in Thompson, line 12 in Spiegelberg. Neugebauer's transcription, my translation. Neugebauer, 'Demotic Horoscopes', 117, says 'Psais: Leo'.
- 38 Line 9 in Thompson, line 13 in Spiegelberg. Neugebauer's transcription and translation.
- 39 At 2, 26; M. Lichtheim, *Ancient Egyptian Literature: A Book of Readings*, vol. III: *The Late Period* (Berkeley/Los Angeles/London: University of California Press, 1980), 142, translates 'exorcising spirits'. Thanks to Micah Ross for this reference.
- 40 Neugebauer, 'Demotic Horoscopes', 120–21; Thompson, 'Demotic Horoscopes', 232–33.

- | | |
|------------------------------------------------|---------------------------------|
| 6) <i>pʒ šy tʒ dʒ.t</i> | 6) The lake of the Duat: |
| 7) <i>pʒ iswe</i> ♈ | 7) Aries. ♈ |
| 8) ////////////// ʕ.wy(?) šy /// ⁴¹ | 8) the house? Shai |
| 9) ////////////// ʕ.wy(?) špšy /// | 9) the house? Shepshy |

In this ostrakon, the text of which is fragmentary, the positions of the Sun and Moon, followed by the four angles (Ascendant, Descendant, Midheaven and IC) and their zodiacal positions are given (lines 1–7), followed by the places of Shai and Shepset, which correlate to the eleventh (Good Daimon) and fifth (Good Fortune). The article *pʒ* is missing, but *šy* correlates to the eleventh place if we reasonably assume, as Neugebauer does, that Aries in line 7 refers to the position of the previous line; Scorpio, then, would follow logically as belonging to the next line and would be the position of Shai.⁴² That fits with the positions of the other given places: if the Ascendant is in Capricorn, then Scorpio would be the eleventh sign from it. The zodiacal sign and the article is missing for *špšy*. It seems likely, however, that this notation refers to the fifth place, as the one opposite to the eleventh; both places are considered to be areas of beneficent influence. Thus we have a list of important places of the chart: the positions of the Sun and Moon, the four angles, and the places of Good Daimon and Good Fortune.⁴³ As a further indication that Shai is representing the ‘fate’ deity, his name is written with the snake followed by the seated god determinative.⁴⁴

Furthermore, the Demotic astrological handbook (P. Berlin 8345) contains the names for the fifth (ʕ.wy špšy(.t)) and the eleventh (ʕ.wy šy).⁴⁵ This text gives

41 Micah Ross kindly inspected the photograph of the ostrakon in Thompson, ‘Demotic Horoscopes’, pl. 28, and thinks that instead of Neugebauer’s *pr*, this and line 9 may read ʕ.wy.

42 Neugebauer, ‘Demotic Horoscopes’, 121, does not understand how this correlates with the previous lines of the ostrakon: ‘. . . the two following “houses,” mentioned in the last two lines (8 and 9), do not fit into the regular scheme as given by Os. 3.’ Thompson, ‘Demotic Horoscopes’, 233, n. i, also is puzzled by what he sees as an inconsistency: ‘These last three lines evidently belong to some other scheme than the previous ones.’

43 Note that the places on this list feature in Dorotheus’s list of important places in I, 5, 2–3 (see below, 62 and n. 77). A recently published birthchart, O. Glasgow D. 1925.96, refers to *šy* in Cancer and *špšy.t* in Capricorn (Quack, ‘Ein astrologisches Ostrakon’, 105–06 [text and German trans.]). Based on the given Ascendant in Virgo, these must mean the 11th and 5th astrological places, just as in Neugebauer’s Os. 5 (Quack concludes the same, 110).

44 By the New Kingdom Shai is commonly a divinity (see Chapter 3, 2.1 and 2.4). Thanks to M. Ross for showing me the demotic glyphs on this ostrakon.

45 IV, 10; III, 1 respectively: see Hughes, ‘Astrologer’s Handbook’, 55.

aphorisms for Venus and Mercury through the places (houses), and every aphorism for the fifth or eleventh says the one born with Mercury or Venus there will be 'happy as to fate' (*ir nfr (n) šy*).⁴⁶ Again, Shai has god determinatives in both places in the text.

The next sections will show that both Zeus Ktesios's connections with acquisition, and Shai and Shepset's connections with fate and fortune, will figure in the Hellenistic astrological interpretations of the eleventh and fifth places. (Other Egyptian connections will also be apparent.)

2.3 *Manilius*

The earliest extant astrological writings on the places of Good Fortune and Good Daimon are those of the Roman poet Manilius (fl. c. 10 CE), who spends almost 200 lines of the *Astronomica's* Book 2 on the way the circle of the chart is divided. He begins (2.788) with the divisions of the circle based on rising, setting, culmination and anti-culmination (the cardinal points), and the astrological associations of these. He moves on (at 2.856) to the twelve-fold division of the circle and what each portion represents. The words Manilius uses for these divisions of the circle are worth some attention. There are six: *pars*, *regio*, *sedes*, *sors*, *locus* and *templum*. He uses *pars*, 'portion', to describe them first, followed in the next sentence by *locus*.⁴⁷ The apportionment becomes the place, which in turn delivers the stars' powers. *Pars* and *sors* have connotations of allotment (which remind us of fate);⁴⁸ *regio*, *sedes* and *locus* are spatial transformations of that allotment.

Then there is *templum*, an unusual word in an astrological context (the usual Greek word for these sections of the chart is *τόπος*; Latin, *locus*). A *templum* is not just a temple; it is 'the area of the sky or land defined (in words) by the augur, within which he took the auspices'.⁴⁹ Manilius first uses *templum* for the first place, the Horoscope, as if to tell us that here, at the intersection

46 P. Berlin 8345, III, 2; IV, 11: see *ibid.*, 55, 57. Not all the aphorisms for all houses and the two planets have survived. Again, thanks to Micah Ross, who went over the photograph of the papyrus with me.

47 2.856–857 (Goold): 'Omne quidem signum sub qualicumque figura / partibus inficitur mundi; locus imperat astris...'. 'In fact every sign, in any figure [*i.e. chart*], is affected by these apportionments of the world; the place commands the stars...'.
48 And Manilius would agree that fate and the stars are joined: see his very first sentence, 'Carmine divinas artes et conscia fati / sidera diversos hominum variantia casus' (1.1–2) among many other similar references. For more on the use of *pars* and *sors*, see Chapter 8, 2.1, 291–93.

49 P. G. W. Glare, ed., *Oxford Latin Dictionary*, Fascicle VIII (Oxford: Clarendon Press, 1982), s.v. 'templum'.

of eastern horizon and ecliptic, is where it all begins, the place to observe the omens of a life.⁵⁰ Without the sacred space determined and marked out for divination by the first place, the rest would not follow. Naturally *templum* also reminds us of the usual associations of a place to worship and propitiate a deity. One assumes that Manilius has chosen his words carefully here, and not just for poetic purposes. His choice seems to deliberately connect augury with astrology.⁵¹ The *templum* created at the first portion of the chart gives the astrologer the means to divine and interpret a life and to propitiate the gods regarding that life.

There are other ways in which Manilius is at odds with astrological tradition in these place-descriptions.⁵² He is the only astrologer, for example, to call the fourth place *Daemonium*⁵³ and the fifth place *Daemonie*. He names the tenth 'Fortune' and assigns Venus to it (her usual place is the fifth). In this he may be in accordance with Egyptian doctrine: in a Demotic chart and an astrological text of this period, the tenth place is called 'the house of the goddess' (*pr ntr.t* or *in-ntrt*).⁵⁴ Wolfgang Hübner suggests an Egyptian influence in Manilius

50 One would think, reading Goold's translation of this section, that Manilius uses 'templum' in every other sentence. This is not the case. It only appears twice: at the mention of the first place (2.943) and at the end, where he speaks of the 'powers of the temples' (2.958–959: 'tali sub sorte notandae / templorum tibi sunt vires').

51 There are also similarities between Manilius's astrology and Etruscan liver divination; see Chapter 8, 294–96. A possible connection may exist between Manilius's use of 'templum' and the Egyptian ꜥꜣꜣ, which has many of the same semantic fields.

52 For more on Manilius's scheme versus conventional astrological doctrine, see W. Hübner, 'Les divinités planétaires de la *Dodécatropos*', in *Les astres: actes du colloque international de Montpellier, 23–25 mars 1995*, 2 vols., vol. 1: *Les astres et les mythes, la description du ciel*, ed. Béatrice Bakhouché, Alain Maurice Moreau, and Jean-Claude Turpin (Montpellier: Université Paul Valéry, 1996), 307–317; also idem, *Die Dodekatropos des Manilius: (Manil. 2, 856–970)* (Stuttgart: F. Steiner 1995).

53 See the discussion of Hübner, *Dodekatropos*, 70–71. This transliteration of the neuter form, δαιμόνιον, only attested for the 4th place here, reflects the pejorative connotation common at this time (e.g. δαιμόνιον in the Septuagint is purely bad: for more on this, see Chapter 4). The fourth here is linked to Saturn and his gloomy associations.

54 See Neugebauer, 'Demotic Horoscopes', 116–17 (Os. 3, l. 21): '*pr ntr.t(?) pꜣ gnhꜥ*' 'The house of the goddess: Cancer'; also A. von Lieven, 'Divination in Ägypten', *AoF* 26, no. 1 (1999): 77–126, here 124: '*pr ntr.t* "Haus der Göttin"'. In P. Vindob. D. 6614, now established as an astrological text by M. J. Smith, in Hughes, 'Astrologer's Handbook', Addendum, 69, the effects of planets in the 10th place (*in-ntrt*, 'goddess'; the word 'house' does not appear) are given; the original in E. A. E. Reymond, *From Ancient Egyptian Hermetic Writings* (Vienna: In Kommission bei Verlag Brüder Hollinek, 1977), 144–45, a4, 8, 12, Plate v1) (see

assigning Typhon to the second and eighth places,⁵⁵ but he makes no mention of Venus and the tenth possibly having Egyptian roots.

Of the 101 lines devoted to describing the twelve places, Manilius spends twenty-two on the eleventh and fifth places (nine for the eleventh and thirteen for the fifth). (See Appendix 2.A.) The eleventh seems almost better than the tenth in its power for good. Its hope makes it ‘better’, it ‘soars up higher’, it ‘may not yield’ to the tenth.⁵⁶ This is because the eleventh is still climbing toward the top of the chart, while the Midheaven is already there and has no place to go but down. Hope makes the eleventh better; the fifth, its opposite, only ‘hopes for honour’⁵⁷ (the honour of having the power of a cardine). The eleventh’s hope seems more pure and more assured—any disappointment is still unrealised.

The eleventh, because it does not know the downward trend the Midheaven has seen, is metaphorically higher and better, even though lower in position. ‘It is, therefore, small wonder, if the [region] nearest the summit, though lower than it, is described by the portion (*sorte*) of Fortune which is entitled “Happy”.’⁵⁸ I think Manilius intends to distinguish between ‘Fortuna’ and ‘Felix Fortuna’ here: his ‘Felix Fortuna’ is not unrelated to the Greek ‘Agathos Daimon’ as well as to the whole idea of *eudaimonia*. Hübner remarks that

also J. F. Quack, ‘Die Spur des Magiers Petese’, *Cd’É* 77 (2002): 76–92, here 90–91). We do not know whether ‘goddess’ means the Moon or Venus here (these would be divinities, not planets but, naturally in an astrological context, the divinity as associated with the planet which bears her name). As Micah Ross points out in ‘A Survey of Demotic Astrological Texts’, *Culture and Cosmos* 11 (2007): 1–25, here 24, for the Egyptians the ‘house of god’ and ‘house of goddess’ are sequential, whereas for the Greeks the God and Goddess places are opposed. Hübner, ‘Divinités planétaires’, 315, also brings up the concept of similar planets being neighbours in Manilius’s arrangement, which places Venus (10th) and Jupiter (11th) next to each other in the upper hemisphere, and Saturn (4th) and Hübner’s posited Mars (5th) in the lower (I say posited because Manilius does not actually mention Mars in the 5th).

55 Hübner, ‘Divinités planétaires’, 315.

56 2.881–884 (Goold): ‘at, quae fulgentis sequitur fastigia caeli / proxima, neve ipsi cedat, cui iungitur, astro / spe melior, palmamque petens victrique priorum / altius insurgit’.

57 2.896 (Goold): ‘sperat honorem’.

58 2.886–888: ‘quocirca minime mirum, si proxima summo / atque eadem inferior [Goold: integrior] Fortunae sorte dicatur / cui titulus Felix.’ See Hübner’s discussion of the textual criticism on this passage in *Dodekatropos*, 51–53. I follow his argument (53) that *dicatur* is a subjunctive of *dicere* rather than a present passive of *dicare*; see also his discussion of the emendations concerning *integrior* by various editors (52–53), where he prefers the ‘inferior’ of Bonincontri, which I also follow.

Manilius avoids using the word ‘daemon’ for the 11th place.⁵⁹ This is true, but I suggest that ‘felix’ is his locution for the Greek εὐδαίμων, thus implicitly calling the place ‘good daimon’.⁶⁰ Here there is a convergence of *tuchē* and *daimōn* in the Hellenistic mind, a convergence which we know also from Plutarch. Frederick Brenk has said that ‘There are innumerable examples in Plutarch’s work where the two words *daimon* and *tyche* seem to be interchangeable . . .’.⁶¹ But when Plutarch, for example, mentions *tuchē* and *daimōn* in the same breath (*Life of Marius* 46.1),⁶² in my view he shows not their interchangeability but their interdependence (we also see this in the passage from the *Laws*, 876c–877b, cited above, 1.1, 49 and n. 12). It is not that *daimōn* and *tuchē* are interchangeable synonyms, but rather that each is dependent on the other; they exist in a symbiotic relationship. *Daimōn* encourages a certain *tuchē* and *tuchē* brings about what has been destined by the *daimōn* (or perhaps *vice versa*). Furthermore, both *tuchē* and *daimōn* are required for achieving happiness, *eudaimonia*. The Fortuna of Manilius’s eleventh place is not *tuchē* as random and arbitrary chance, but as serendipitous good luck. Because the eleventh place is still rising, it is able to provide blessings and aids to happiness. Manilius

59 Hübner, *Dodekatropos*, 53.

60 Manilius is conversant with Greek terms, and uses them in the *Astronomica* when there is no alternative. Daimon is difficult (see Hübner, *ibid.*, 51 and n. 125, where he cites Housman’s collection of citations showing the difficulties Romans had with translating the word δαίμων), but here, though, he can use the Latin *felix*. Hübner, 35, compares the *felix* of the 11th with the *infelix* used of the 12th, the Latin symmetry matching the Greek symmetry of *agathos* and *kakos daimōn*. Manilius’s familiarity with ‘happiness’ and its philosophical ramifications might well arise, in this instance, from his following of Posidonius, who wrote about *eudaimonia* and its daimonic connections (see Chapter 4, 1.3, 124 and n. 43). (For a discussion of Manilius’s philosophical influences, see, e.g., K. Volk, *Manilius and his Intellectual Background* (Oxford: Oxford University Press, 2009), 226–51, esp. for Posidonius, 231–32.)

61 Brenk, *In Mist Apparellled*, 147, though he adds, ‘one cannot help suspecting that the use of one word or the other is for stylistic reasons.’ However, he develops this argument of interchangeability in the rest of Chapter 8 (esp. 147–54). ‘Interchangeable’, though, implies that the two words are more or less synonymous. To the modern reader, Plutarch may seem sloppy in his use of these words, but we cannot assume that an ancient reader would not have understood the nuances behind the words in their contemporary contexts. Brenk, I think, goes too far in his argument of interchangeability. See also S. Swain, ‘Plutarch: Chance, Providence and History’, *AJPh* 110, no. 2 (1989): 272–302, here 273–274, who has accepted Brenk’s ‘interchangeability’ argument.

62 (Lindeskog/Ziegler, vol. 3.1): Πλάτων μὲν οὖν, ἤδη πρὸς τῷ τελευτᾷ γενόμενος, ὕμνει τὸν αὐτοῦ δαίμονα καὶ τὴν τύχην. . . . ‘Plato, however, now coming near to death, sang the praises of his Daimon and Fortune . . .’

associates Jupiter, the king of the gods, with this place: 'Jupiter hac habitat' (2.890). Jupiter in the eleventh place almost always portends something good.

The fifth place, for Manilius, is more problematic. Unlike the eleventh, it is below the horizon—the poet juxtaposes words like 'deep' (*imus*), 'sunken' (*summersus*) and 'cast down' (*deiectus*); even the future reward of being an angle will only be a 'yoke' and a 'burden' (*iugum, onus*).⁶³ It further has power over the courses of health and disease. Perhaps this is because of a parallel construction with the ninth place: the fifth is the western side of the IC, the ninth the western side of the MC (to which Manilius assigns the 'defects and fortune' of our bodies).⁶⁴ This association with sickness and health is unlike traditional descriptions of the fifth, which stress fertility and children. A few references to illness and the fifth can be found, however: Firmicus associates illness with Mercury in the fifth with a waxing or waning Moon;⁶⁵ Rhetorius makes the same association of Mercury and Moon to illness when in the fifth or eleventh.⁶⁶ By contrast, Paulus⁶⁷ and Olympiodorus⁶⁸ say Jupiter in the *eleventh* (the fifth is not mentioned) has the power to prevent injury and illness.

Though health is often important for happiness, its inclusion here hardly makes the fifth a place of automatic good fortune. In Manilius's scheme, health is a battleground for god in a war with the power of chance or accident (*casus*, not *fortuna*): 'with the twin forces of chance and god'.⁶⁹ The adversarial relationship of god and accident is interesting: is god not all-prevailing over the power of chance? Or is chance associated with the daimon as opposed to god?

For the name of this place, says Manilius, is 'Daemonie'.⁷⁰ Manilius reverses what other astrologers do: he calls the eleventh 'Fortune' and the fifth 'Daemonie'. When 'Daemonie' is used for the name of an astrological place (its

63 2.891–892, 895–896.

64 2.907–908: '... corpora nostra / concipiunt vitia et fortunam...'. Further supporting a parallel construction, the description of the ninth immediately follows that of the fifth. Housman (Manilius, *Astronomicum, Liber Secundus*, ed. A. E. Housman (London: Grant Richards, 1912), xxx, gives the places located in terms of east and west of the MC/IC axis.

65 *Mathesis*, III, 7.10.

66 *Compendium*, in *CCAG VIII/4*, 154.10–12; 174.8–11.

67 Paulus, ch. 24 (Boer, 69.14–15).

68 Olympiodorus, ch. 23 (Boer, 73.26–27).

69 2.903: 'viribus ambiguam geminis casusque deque'.

70 2.897: 'Daemonien memorant Grai...'. Hübner, *Dodekatropos*, 54–58, suggests Mars should be assigned to this house, where it has migrated from the 6th to replace a Venus gone to the 10th. It is an intriguing suggestion, but his evidence seems tortuous and somewhat unconvincing. If Manilius meant for Mars to be the god of the 5th, why didn't he say so? He is perfectly clear about Venus in the 10th.

use in general is very rare),⁷¹ it is for the sixth,⁷² where the association is with a 'bad daimon,' not a good one. But Manilius says, 'Keep in your wise heart the place and its divine authority (*numen*), and its powerful name . . .'⁷³ This does not seem to be apotropaic against a bad daimon.

I see two possible explanations for this use of *daimonie*. First, this melding of divine authority with the name of Daimon may be a throwback to an earlier concept of daimon. *Daimonie* is used as a form of address in Homer and Hesiod, a tacit acknowledgement of the divinity which prompts, warns or gives insight to the human.⁷⁴ Is the power of the fifth, then, the daimonic power of the ministering and administrating daimon to carry out the *numen* of god? Calling the place 'Daimonie' (and not associating a god with it) may be akin to something like the Middle Platonic hierarchical levels of divinity, with an all-powerful 'primary' God at the top and daimons, with limited power, at the lowest divine level.⁷⁵

My second explanation considers the Egyptian/Demotic characterisation of this place as *t3 špšy(t)*, the Egyptian divinity Shepset, a goddess of wealth and nobility who was personally assigned to each human at birth.⁷⁶ Manilius says 'Daimonien memorant Grai' (2.897); he uses the verb *memoro*, 'recall, speak of', not *nomino* or *appello*, but in fact this attribution does not appear in Greek writings. We have already seen that Manilius may follow Egyptian doctrine in associating the tenth with Venus. Could it be that here Manilius is drawing not from Greek doctrine, but Egyptian doctrine—from the Egyptian Shepset who, as a lesser divinity and female, would thus be considered 'daimonie'? In this case, Shepset may represent a (good) fortune that is by chance (*casus*). We shall explore this idea further in Chapter Three, 2.3.

71 The *TLL* (v.1, s.v. 'daemonius') gives only three references: this one (2.897), the one referring to the fourth place (2.938) and one from Verecundus, which appears to mean 'demonic' and seems unrelated to this connotation of 'daimonie'. The Library of Latin Texts gives only this (2.897) for 'daimonie'.

72 Goold reports (Loeb trans., 153, note *d*) that 'Housman can only find two occurrences of the term [Daimonie], each obscure and signifying temple 6 . . .'. The references are to P. Mich.inv. 1, 149, col. ix.16 and Thrasyllus, *CCAG* VIII/3, 101.23 (see Chapter 4 for a discussion).

73 2.898–899: ' . . . sub corde sagaci / conde locum numenque loci nomenque potentis'.

74 Dodds, *Greeks and the Irrational*, 11–12.

75 *Epinomis*, 984e, describes daimons as below the gods. The rôle of daimons possessing powers to control a portion of fate is elucidated in the Ps.-Plutarch essay 'On Fate' (see Chapter 1, 2.1).

76 For more about this goddess and the Demotic fifth place, see above, 2.2 and Chapter 3, 2.3, 101–03.

2.4 *Dorotheus of Sidon*

For Dorotheus, the superiority of the eleventh and fifth places is surpassed only by the Ascendant and Midheaven:

So the best of the places is the ascendent, then the midheaven, then what follows the midheaven, which is the eleventh from the ascendent, then the opposite to this eleventh place from the ascendent, which is the fifth from the ascendent which is called the house of the child, then the opposite to the ascendent, which is the sign of marriage, then the cardine of the earth, then the ninth place from the ascendent. Thus these are the seven places which are preferred. . . .⁷⁷

Hephaestio follows Dorotheus also.⁷⁸ Here is the usual association of the fifth with children (Demotic charts also called the fifth the house of the child).⁷⁹ Dorotheus tells us that a malefic in the eleventh ‘indicates destruction and weakness’ [of property],⁸⁰ but most authors (especially Valens) say otherwise, that a malefic’s power to do bad is blunted because of the inherent goodness of the eleventh.

Children are discerned mainly from the fifth, but their sex from the Midheaven and the eleventh, according to Dorotheus;⁸¹ he also looks at Jupiter for children (11, 8), perhaps a reason why the eleventh is involved in the question of children. (Perhaps the Midheaven is used because of the connection of Venus—by the Egyptians and Manilius—to the tenth.) The number and vitality of children are determined from these places. In event charts and interrogations, a significating planet in the tenth or eleventh is given great power.⁸²

Elsewhere Dorotheus (at least in the Arabic version of his text), like Manilius, also uses the word ‘fortune’ for the eleventh: ‘. . . the eleventh sign, which is the sign of fortune . . .’⁸³ Dorotheus illustrates the power of the

77 Dorotheus, I, 5.2–3 (Pingree, 164). My underlining of the relevant information.

78 Hephaestio, I, 12.1 (Pingree, I, 39.8–12) = Dorotheus (Pingree, 325.18–24). In Hephaestio’s text the usual names of the places are given for the 11th and 5th: ὁ ἀγαθὸς δαίμων, ἡ ἀγαθὴ τύχη.

79 E.g., Ostrakon 3 in Neugebauer, ‘Demotic Horoscopes’, 116–17, dated to 18 CE (= ostrakon in Spiegelberg, ‘Namen und Zeichen’, 149–50).

80 Dorotheus I, 26.31 (Pingree, 192).

81 11, 12.16 (Pingree, 211): ‘Look from the midheaven in the matter of the nativity [and] which [planet] aspects midheaven, and where its lord is, and of what sort the sign is, and where its witness is, and which [sign] follows midheaven; this indicates males and females.’

82 V, 17.2–3 (Pingree, 275; also 394.1–2 [= Hephaestio, III, 11.2]).

83 I, 25.8 (Pingree, 190). Here place and sign are equated.

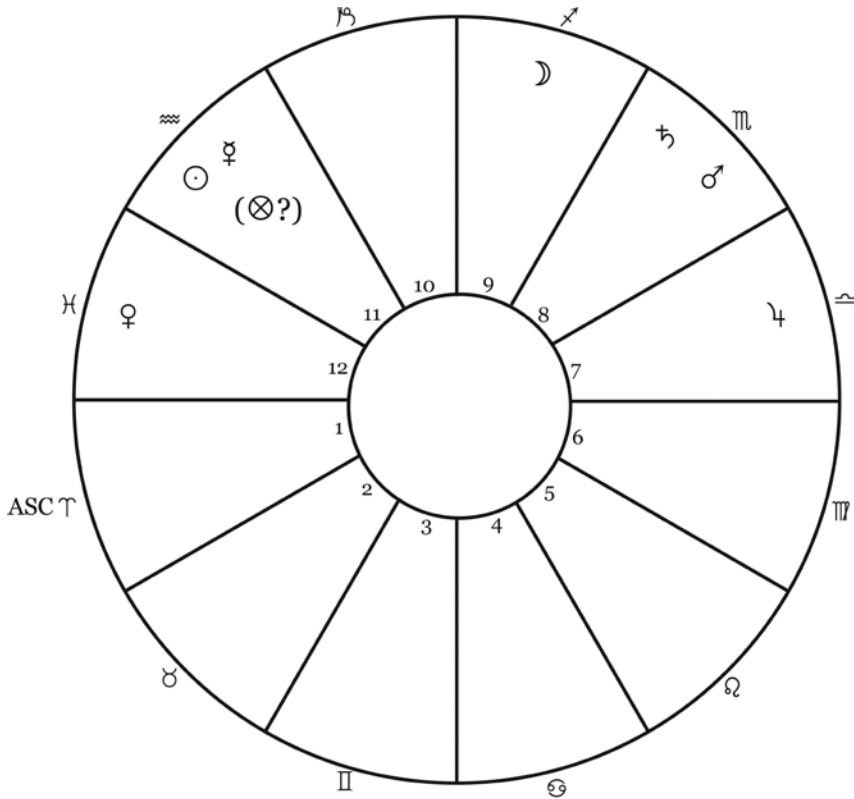

FIGURE 2.2 Chart illustrating triplicity lords and fortune in Dorotheus.⁸⁴

eleventh place for acquiring fortune and property, using triplicity lords of the sect ruler (Sun by day and Moon by night). This power aligns with the attributes of Zeus Ktesios.

Text: [5] This nativity was diurnal, and Aries was becoming visible at that hour in the East from out of the depths of the sea, and the lord of the Sun's triplicity was Saturn, then Mercury. [6] Saturn was in what follows the cardine of the West and Mercury in what follows the cardine of the midheaven, which is the place of fortune, so that the native should be wealthy, rich, powerful in business affairs, great in property, seizing eminence and fortune and increasing in them.

84 I, 24 (Pingree, 185); Text: I, 24.5–6. Chart dates to 26 January 13 CE.

The triplicity rulers of air are Saturn by day and Mercury by night. Dorotheus's interpretation of a 'wealthy' native is interesting, because one would expect more of an emphasis on Saturn, as a diurnal planet in a diurnal chart; and Saturn, in the eighth, ought not to be very good for fortune. But Dorotheus, instead, emphasises Mercury in the eleventh. Two reasons are possible for this: the eleventh as a 'place of fortune'⁸⁵ trumps the primary triplicity ruler; and the Lot of Fortune also falls in the eleventh (though Dorotheus does not mention it), thus amplifying the possibility of wealth, power, eminence and fortune. The power of the eleventh and Fortune preempt the proper sect ruler and the badness of the eighth. In other examples in this chapter, Dorotheus predicts a good outcome if both triplicity lords are in good places, a bad outcome if both are in bad places. (This is the only example he gives with one triplicity lord in a good place and one in a bad place.)

2.5 *Thrasyllus, Antiochus of Athens, P. Mich.inv. 1, 149*

These three authors are representative of the mainstream tradition of the eleventh and fifth places. Thrasyllus (d. ca. 36 CE, astrologer to Tiberius) purportedly gives the doctrine of 'Hermes Trismegistus' in the following descriptions. He says that the Hour-marker is 'a rudder and indicative of fortune, soul and manner of life' (this must be a general sort of fortune), the fifth is 'Good Fortune' and the '11th zodiac sign in the chart he [*i.e. Hermes*] called Good Daimon'.⁸⁶ Thrasyllus may be the earliest author to refer to the eleventh as the place of the Good Daimon.

The author of *P. Mich.inv. 1, 149*, which was transcribed and translated by Frank E. Robbins,⁸⁷ tells us that his descriptions of the places come from

85 The Arabic uses the word *makaan*, 'place' in a non-technical sense; the normal astrological word for place is *bayt* (house). (I thank Charles Burnett for examining the Arabic for me.) We cannot tell whether Dorotheus merely means the 11th as a place of fortune, or the specific place of the Lot of Fortune. See also discussion in Chapter 9, section 4, 311 in this volume.

86 *CCAG VIII/3, 101.18–19, 22–23, 28–29*:... τὸν μὲν ὠροσκόπον οἶακα καὶ τύχης καὶ ψυχῆς καὶ τρόπου ζωῆς δηλωτικὸν ἀποφαίνων... τὸ δὲ ε' ἀγαθὴν ἐκάλει τύχην... τὸ δὲ ια' ἐν τῷ διαθέματι ζώδιον ἀγαθὸν ἐκάλει δαίμονα... In this text Thrasyllus also calls the Midheaven 'τύχη' (*CCAG VIII/3, 101.26*), among other attributions, suggesting he and Manilius, who calls the tenth 'Fortuna', were drawing on the same (Egyptian?) source (which Thrasyllus calls 'Hermes Trismegistus').

87 In J. G. Winter, ed., *Papyri in the University of Michigan Collection: Miscellaneous Papyri*, vol. III (Ann Arbor: University of Michigan Press, 1936). The papyrus is online at <http://quod.lib.umich.edu/a/apis/x-1290/1xix.tif-2>.

‘Asclepius’; it is written, according to Robbins, ‘in a hand of the second century’.⁸⁸ The fifth is called Good Fortune and is the place of children, and the eleventh is Good Daimon.⁸⁹ He has an unusual system of dividing the quadrants into either *krataios* or *daimoniōdes* degrees (discussed in Chapter Four).

Antiochus of Athens (*floruit* probably the second century CE) wrote both a *Thesaurus* and an *Introduction* (portions of the *Thesaurus* are preserved by Rhetorius; portions of the *Introduction* correlate to Porphyry’s *Introduction*). In the *Thesaurus*, he tells us that the ‘post-ascension of the Midheaven’ is an ‘operative’ place, along with the four angles, the fifth and the ninth.⁹⁰ His *Introduction* has more detail: ‘The fifth place is called Good Fortune, signifying both the acquisition of living beings⁹¹ and the increase of things pertaining to living.’⁹² This is slightly unusual, not only because of the reference to what might be called ‘chattel’ (that seems more a concern of the sixth place), but because acquisitions are usually assigned to the eleventh place (the eleventh place from the Lot of Fortune is, in Vettius Valens, a ‘place of acquisition’).⁹³ For Antiochus, the eleventh is ‘the post-ascension of the Midheaven and Good Daimon, and signifies increase of future revenue.’⁹⁴

2.6 Ptolemy and Hephaestio

Ptolemy uses the eleventh place only in connection with determining life expectancy.⁹⁵ It is clear that he values the eleventh not for its significance as a place of the ‘Good Daimon’, but for its geometrical relationship to the degrees of the Hour-marker (Ascendant). Places worthy of containing an *aphetēs*,

88 Ibid., 62.

89 Ibid., col. ix.16, 19–20; pp. 74 (text), 112 (translation).

90 Antiochus, *Thes.*, CCAG I, 157.14–15: Χρηματιστικοί μὲν τόποι εἰσὶ τὰ τέσσαρα κέντρα καὶ τὰ β' τρίγωνα ἐκάτερα τὰ ὠροσκόπου καὶ ἡ ἐπαναφορὰ τοῦ μεσουρανήματος. This is similar to Porphyry’s *Introduction to the Tetrabiblos*, CCAG V/4, 209.19–21: Χρηματίζει πάση γενέσει ζῴδια ζ' κατὰ <Τίμαιον> κέντρα μὲν δ', τρίγωνα δὲ τοῦ ὠροσκόπου β', πρὸς δὲ τούτοις ἡ ἐπαναφορὰ τοῦ μεσουρανήματος. . . .

91 ‘ἐμψύχων’; animals, and also slaves?

92 Antiochus, *Intr.*, CCAG VIII/3, 117.7–9: ἀγαθὴν τε τύχην τὸ ἀπὸ ὠροσκόπου πέμπτον καλεῖσθαι, ἐμψύχων τε κτήσιν καὶ βιωτικῶν αὔξησιν πραγμάτων σημαίνειν.

93 *Anthology*, II, 21.1 (Pingree, 78.18–19). See below, n. 98.

94 Antiochus, *Intr.*, CCAG VIII/3, 117.16–17: τὸ δὲ ια' ἐπαναφορὰ μὲν τοῦ μεσουρανήματος καλεῖσθαι καὶ ἀγαθὸν δαίμονα καὶ αὔξησιν σημαίνειν τῶν ἐσομένων. Again, this correlates to the power of Zeus Ktesios.

95 Ptolemy’s focus is generally planetary significations, not the traditional places and their assignments.

from which life is ‘released’⁹⁶ are only those above the horizon in an accepted geometrical figure to the Hour-marker: the hexagon for the ‘Good Daimon’, the square for the Midheaven, the triangle for the place of ‘God’ and the diameter for the Setting place.⁹⁷ Of these, the most preferred for predomination are, in order, the Midheaven, the Ascendant, the eleventh, the seventh and the ninth. Note that all these aspects/figures are right-hand ones (the left-hand ones fall under the horizon).⁹⁸ This association of the right with being above the horizon may influence the power given, in general, to the places above the horizon like the eleventh, the midheaven, the ninth and the seventh. In Arabic astrology, when the hemispheres created by the horizon become more important in the determination of the sectal dignity of a planet, a nocturnal planet in ‘hayyiz’ is always in the upper hemisphere of the chart.

Hephaestio follows the scheme of Ptolemy precisely, and reminds us that the ‘5 degrees in pre-ascension behind the Hour-marking degree up to the remaining 25 degrees post-ascending’⁹⁹ encompass the degrees which can be taken as aphetic for the other places in a right-hand geometrical relationship to these Hour-marking degrees.

For children, Ptolemy prefers the Midheaven and eleventh, because they are ‘consequent to the place concerning marriage’ (i.e., the seventh), although he says that one can also look at the ‘diameter’ of these, i.e., the fourth and fifth places.¹⁰⁰

One place where Ptolemy and Hephaestio differ is in their coverage of katarchic charts. In Book III, Hephaestio incorporates the fifth and the eleventh places into his schemes for interpreting these charts. In a *katarchē* for a banquet, the fifth shows those who are invited, and the eleventh the preparation for the feast.¹⁰¹ He also delineates the ninth, tenth and eleventh in a

96 For definition, see Appendix I.A, 3.1., 412.

97 *Tetrabiblos*, III, 11.563–575 (Hübner).

98 For more on the strength of right vs. left, see Chapter 4, 2.5, 154–55.

99 Hephaestio, *Apotelesmatika*, II, 11.3 (Pingree, I, 116.18–20):...ε μοιρών εις τουπισω προαηνηγεμενον της ωροσκοπουσης μοιρας μεχρι των λοιπων και επαναφερομενων μοιρων κε....

100 *Tetrabiblos* IV, 6.383–387 (Hübner).

101 Hephaestio, III, 36.3 (Pingree, I, 294.16, 19); also Ep. I, 45.3 (Pingree, II, 28.25, 29.1). See 309 (Diagram Nos. 19a and 19b), 151–56 in W. Hübner, *Raum, Zeit und soziales Rollenspiel der vier Kardinalpunkte in der antiken Katarchenhoroskopie* (Munich/Leipzig: K. G. Saur Verlag, 2003). Hübner’s work was especially helpful in this section on katarchic charts. See also the analysis of A. Pérez Jiménez, ‘Περὶ δειπνου. A propósito de Heph., III 36’, *MHNH* 2 (2002): 237–53.

katarchē as showing the past, present and future respectively.¹⁰² Julian of Laodicea (fl. ca. 500 CE) enlarges this schema: ‘For all [sc. places] (i.e., the centrepins, post-ascensions and declines) past time is the decline, present time the centrepin itself, future time the post-ascension.’¹⁰³ This time-scheme has interesting implications. The order is secondary (zodiacal) motion, so the passage of time is correlated to the movement the planets make through the zodiac. The angles, which mark changes in direction and time, represent the present, the actuality of events and where change becomes real. Declines are the past, which cannot be changed. The succedent places, then, represent the uncertain (to humans) future, where change is unrealised. Two succedents are the Good Fortune and Daimon places, where benefics rejoice; are these places, then, where change can be negotiated?

2.7 *Vettius Valens*

Valens comprehensively covers both the power and the meaning of the places. Like Ptolemy, he suggests the eleventh to determine children; the fifth is inspected for marriage (II, 16). The eleventh always bestows good things, especially with benefics, but even malefics there ‘do not have the capacity to do any evil’.¹⁰⁴ Hephaestio also mentions this as a dictum of some of the ‘ancients’ (including Porphyry): ‘when malefics happen to be present in this place, the *n*th, . . . they do not do evil; all the same, one must admit that they harm to a certain degree as the age [of life] progresses.’¹⁰⁵

The fifth place, as well, is a place of good things. Planets in the fifth, especially if they rule the Ascendant or the Lot of Fortune, bring about great good fortune, based on each planet’s particular powers. Aphrodite will make them wealthy and honoured, Ares generals or tyrants, Kronos property-holders and founders of villages, the Sun those who are close to kings, Hermes advancing through words, and the Moon those who are long-lived.¹⁰⁶

102 Hephaestio, III, 4.3 (Pingree, I, 231.24–27). (See 288, Diagram No. 10a in Hübner, *Raum*.)

103 Julian of Laodicea, *CCAG* IV, 104.29–105.1 (as in Hübner, *Raum*, 90): ἐπί δὲ πάντων (τουτέστι τῶν κέντρων καὶ τῶν ἐπαναφορῶν καὶ τῶν ἀποκλιμάτων) ὁ παρεληλυθὼς μὲν χρόνος τὸ ἀπόκλιμα [sc. ἐστίν], ὁ δὲ ἐνεστὼς αὐτὸ τὸ κέντρον, ἡ δὲ ἐπαναφορὰ ὁ μέλλων.

104 Valens, II, 6.3 (Pingree, 61.16): . . . οὐκ ἰσχύουσι κακὸν τι δρᾶσαι. (Similar at II, 12.9, 65.2.)

105 Hephaestio, II, 18.15 (Pingree, I, 157.1–4) (= Dorotheus [Pingree, 338.16–19]): Ἄλλοι μέντοι τῶν ἀρχαίων εἰρήκασιν ἐν τῷ τόπῳ τούτῳ τῷ ἰα΄ μὴ κακοποιεῖν τοὺς κακοποιούς παρατυχόντας (ὧν εἷς καὶ Πορφύριος)· ὅμως χρηὴ παραδέχεσθαι αὐτοὺς ποσῶς βλάπτοντας προϊούσης τῆς ἡλικίας.

106 Valens II, 12.1–8 (Pingree, 64.16–65.1): Ἐὰν οἱ ἀγαθοποιοὶ τύχῳσι τὸν ὠροσκόπον ἢ τὸν κλήρον τῆς τύχης λαχόντες, ὁ γεννώμενος μέγας ἔσται καὶ ὄχλων ἡγήσεται καὶ νόμους θήσεται. Ἀφροδίτη τὰ μέγιστα χαρίζεται κυριεύουσα τοῦ ὠροσκόπου ἢ τοῦ κλήρου, μάλιστα ἰδιοπροσωπούσα ἢ

In IX, 3, Valens lays out the technique of derived places, in which the astrologer takes the topic to be discussed (whether children, parents etc.) and delineates the other places in relation to that topic. For example, if one were asking about siblings, one would make the third place, which represents siblings, the first place. The natal first place would become the 'Good Daimon and place of [children and]¹⁰⁷ friends.¹⁰⁸ In other words, the first place is in an eleventh-place position to the third, and thus becomes the sibling's children and friends. The same is done for the other places in relation to the third.

Valens also does some rather unusual things in regard to the Good Daimon and Good Fortune places. First, he highlights the power of the eleventh place in his techniques utilising the Lot of Fortune: the eleventh place from Fortune is seen as 'acquisitive, a giver of goods and possessions, especially when benefics are in it or witnessing.'¹⁰⁹ This idea seemingly arises from the ability of the eleventh to provide benefits, particularly acquisition of goods. When describing the signs in Book I, Valens calls Taurus the 'acquisitive zodiac sign of the cosmos', a reference to the *thema mundi* which has Cancer as its Ascendant; the eleventh place/sign would thus be Taurus).¹¹⁰

Second, Valens explains that the power of the Good Daimon or Fortune places can give a sextile the power of a trine:

Sextiles with one another [*sc.* planets] become more moderate in power. Yet when they are in the Good Daimon and Good Fortune [places], noth-

ἰδίῳ τόπῳ οὐσα· εὐκτήμονας, ἐντίμους ἀποτελεῖ. τὸ αὐτὸ καὶ ἐπὶ πάντων τῶν ἀστέρων· ἐὰν γὰρ κρατῶσι τῆς ὥρας ἢ τῆς τύχης, ποιήσουσι τὰ ἀγαθὰ κατὰ τὸ ἐπιβάλλον τῇ ἰδίᾳ φύσει καὶ τὸ τῆς ἀγαθῆς τύχης ἴδιον. ἐὰν δὲ ὁ τοῦ Ἄρεως τύχη καθ' ὃ πρόκειται, ἄρξουσι παντοδαπῶν τόπων· γίνονται γὰρ ἢ στρατηγῶν ἢ τύραννοι καὶ ζωῆς καὶ θανάτου κυριεύουσιν οὐ μόνον ἐλαχίστων ἀλλὰ καὶ ἀξιολόγων ἀνθρώπων. ἐὰν δὲ ὁ τοῦ Κρόνου ἐπιπαρῆ τῷ τόπῳ, πολυκτήμονας ἐγγαίων καὶ τετραπόδων δεσπότης, κτίζοντας κώμας καὶ τόπους. εἰ δὲ ὁ Ἥλιος ἐπιπαρῆ, μεγιστάνων φίλους, ἐγγὺς βασιλέων, ἱερῶν ἄρχοντας. εἰ δὲ ὁ τοῦ Ἑρμοῦ, τὰς διὰ λόγων προκοπὰς καὶ χρημάτων πλείστων καταξιουμένους. εἰ δὲ ἡ Σελήνη καλῶς σχηματιζομένη κληρώσεται τὸν κλῆρον ἢ τὸν ὠροσκόπον, ἐπὶ τοῦ ζῳδίου τυχοῦσα σὺν τῷ οἰκοδεσπότη αὐτῆς, πολυχρόνιο γίνονται καὶ συγγηράσκουσιν ἐν εὐδαιμονίᾳ.

107 Square brackets are Pingree's, meaning he thought it should be omitted; but the 11th is sometimes the place of children, as we have seen.

108 IX, 3,7 (Pingree, 321.12–13):... τοῦ δὲ περὶ ἀδελφῶν ὁ ἀγαθὸς δαίμων καὶ [τέκνων καὶ] φίλων τόπος....

109 II, 21.1 (Pingree, 78.18–19):... περιποιητικόν, ὑπαρχόντων καὶ ἀγαθῶν δοτῆρα, καὶ μάλιστα ἀγαθοποιῶν ἐπόντων ἢ μαρτυρούντων. One of Valens' examples is delineated in Chapter 9. Rhetorius mentions the eleventh from Fortune also: see CCAG VIII/4, 124.20.

110 I, 2.14 (Pingree, 7.3): Ἔστι δὲ τὸ ζῳδίου κόσμου περιποιητικόν.... See Appendix I.A., 3.4, 'Thema mundi'; also the discussion in Chapter 5.

ing keeps them from [the power] of the trine, especially if a tropical or equinoctial zodiac sign happens to be in the middle, and even more if the figure [*i.e. aspect*] should be observed in Pisces and Taurus.¹¹¹

This characterisation may have been prompted by the natural relationship of the eleventh to the first (Ascendant) place, a sextile; and that of the fifth, a trine. It is a distinct tribute, in any case, to the power of the fifth and eleventh places to do such a thing. This capacity is augmented when the sextile crosses the solstitial axis, or especially the equinoctial axis, particularly the Aries point. This juxtaposition of the fifth/eleventh axis with the equinoctial signs is also intriguing. Is there an implicit suggestion that the power of *daimōn* and *tuchē* aligns with, even enhances, the power of the equinox? There is a similar passage in Firmicus, II, 22.8: ‘But those sextiles are more powerful which have tropical or bicorneporeal signs in the middle, but those which are separated by solid signs are unproductive.’¹¹² Here the reference to the fifth and eleventh places has been lost, and only the tropical remains, to which the mutable signs have been added.¹¹³

2.8 *Julius Firmicus Maternus*

The *Mathesis* also deals with the places in great detail. Firmicus not only describes the places and their general assignments, but has exhaustive lists of how each planet behaves in the places, both singly and in tandem with other planets. I have selected examples to illustrate how Firmicus thinks about each of the places and their influences. Many of Firmicus’s descriptions correlate with those in the *Liber Hermetis*.¹¹⁴

Book II contains Firmicus’s exposition of the places, beginning with the eight-place system (*de octo locis*). Children belong to the fifth. Then Firmicus discusses the important places in order; here, the fifth and eleventh (along with the third and ninth) are singled out for virtue: ‘After these four cardines . . . there are four other places in nativities which have ensuing and favourable power,

111 II, 17.32–33 (Pingree, 69.23–26): ἐξάγωνοι δὲ πρὸς ἀλλήλους μετριώτεροι τῇ δυνάμει γίνονται. ἐπὶ μέντοι τοῦ ἀγαθοῦ δαίμονος καὶ τῆς ἀγαθῆς τύχης οὐδὲν ἀπέχουσι τοῦ τριγώνου, μάλιστα αἰ μέσον τροπικὸν ζῳδιὸν ἢ ἰσημερινὸν τύχη, πολὺ δὲ μᾶλλον ἐὰν Ἰχθύσι καὶ Ταύρω τὸ σχῆμα θεωρηθῆ.

112 *Mathesis*, II, 22.8 (KSZ, I, 70.19–22 = Monat, I, 124): ‘Sed exagona illa sunt potiora, quae habent in medio tropica vel duplicia signa, inefficacia vero, quae signis solidis dividuntur.’

113 We cannot say that Firmicus knew this doctrine from Valens. Although he cites a number of other astrologers, Firmicus does not mention Valens in his text.

114 See the concordances in Simonetta Feraboli’s edition of the *Liber Hermetis*.

i.e. Goddess, God, Good Fortune and Good Daemon, which are so named by the Greeks: *thea*, *theos*, *agathe tyche*, *agathos daemon*.¹¹⁵ Next, he gives the major attributes of each place. For the fifth, he says: 'From this place the number of children and the quality of their descent is found. It is called, moreover, Good Fortune, because it is the place of Venus.'¹¹⁶ Firmicus makes much of the fact that the fifth trines the Ascendant, even though the Midheaven (if set in the eleventh) sometimes opposes it.¹¹⁷ The eleventh, he says, 'is called Good Daemon or Good Genius by us, *agathos daemon* by the Greeks. In this place the Midheaven is frequently found by degree. Moreover, it is the place of Jupiter and is joined in no paltry association with the Horoscope; for it sees the Horoscope from a sextile ...'¹¹⁸

Many sections of the *Mathesis* deal with the effects of planets in the places, in various configurations and permutations. Chapters 2–13 of Book III describe all the planets in the places. Sect is always an important factor in how well or badly the planet behaves. Thus Saturn by day and Mars by night are always better than the reverse. The fifth and the eleventh, in general, are concerned with acquiring power, status and/or fortunes, and keeping them. In addition, the fifth gives indications for children based on planets in it and aspects to it. In VI, 30, Firmicus gives mythical charts of famous Greeks; all these charts have the same configurations (but in different signs) which emphasise the trine relationship of the Ascendant to the fifth and the ninth. Each chart is cleverly arranged to fit with the attributes of its holder. For example, 'Homer's' chart has the fifth place Moon in Aries in the degrees that cause blindness, trining Mars and Mercury in the first, a fitting placement for a blind poet who wrote about war.

115 II, 16.1 (KSZ, I, 59.14–19 = Monat, I, 111–112): 'Post hos quattuor cardines . . . alia sunt in genituris quattuor loca, quae sequentem et secundam habent potestatem, id est Dea Deus Bona fortuna ac Bonus daemon, quae a Graecis hactenus nominantur: *thea*, *theos*, *agathe tyche*, *agathos daemon*.'

116 II, 19.6 (KSZ, I, 62.18–20 = Monat, I, 115): 'Ex hoc loco filiorum numerus et generis qualitas invenitur. Appellatur autem Bona fortuna, quia locus est Veneris.'

117 II, 19.6 (KSZ, I, 62.20–24 = Monat, I, 115): 'Sed et hic locus cum horoscopo maxima societate coniungitur et interdum in diametro huius signi MC. pars constituitur. Ideo autem cum horoscopo maxima coniunctione sociatur, quia horoscopum <de trigono respicit et> de trigono ab horoscopo videtur.'

118 II, 19.12 (KSZ, I, 64.23–28 = Monat, 117–18): 'Appellatur autem hic locus a nobis Bonus daemon vel Bonus genius, a Graecis *agathos daemon*. In hoc loco medium caelum frequenter partiliter invenitur. Est autem locus Iovis et cum horoscopo non parva societate coniungitur; de exagono enim horoscopum videt . . .'

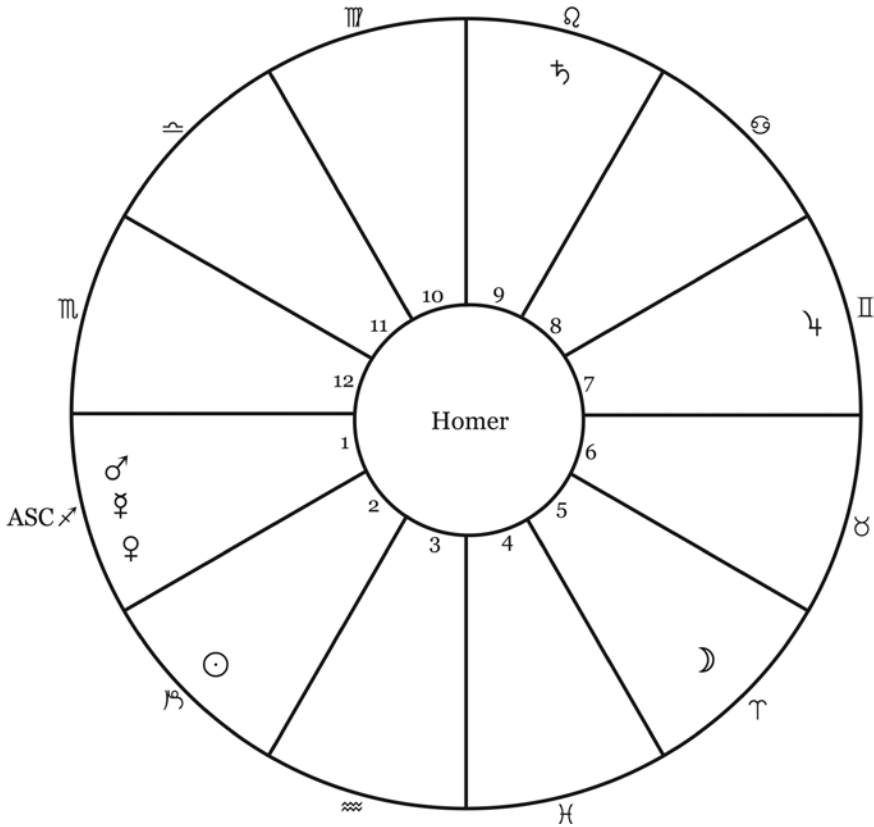

FIGURE 2.3 Firmicus's chart of 'Homer'.¹¹⁹

Chapter 31 continues delineating various configurations of planets in places. The Latin of sentence 24 reads:

Si in v ab horoscopo loco vel in xI Venus et Jupiter pariter sint <constituti>, et eos nulla [<benivola>] stella ex aliqua parte respiciat, difficiles nuptias aut graves decernunt ex nuptiis simultates, ut semper acerbis dissensionibus implicati iurgia inter se [simul] malignae simultatis exercent.¹²⁰

119 VI, 30.23 (KSZ, II, 146.24–147.12 = Monat, III, 81).

120 VI, 31.24 (KSZ, II, 154.18–23 = Monat, III, 89). Monat omits 'benivola'; I use Monat's 'exercent' for KSZ's 'exerceant'.

Unfortunately, there are both textual and translation problems here. Kroll, Skutsch and Ziegler inserted 'benivola' in lines 19–20; Monat removed it,¹²¹ but both Bram and Monat have translated similarly the configuration under discussion as 'Venus and Jupiter in conjunction' (Bram), 'se trouvent ensemble Vénus et Jupiter' (Monat).¹²² This must be misinterpreting the word 'pariter', which both have assumed means 'together'. But Venus and Jupiter together in the fifth or eleventh producing 'difficult marriages' (*difficiles nuptias*) is nonsensical. *Pariter* here must mean, not 'together' as in 'in the same place', but 'at the same time', meaning that Venus and Jupiter must be *opposed* to each other in either the fifth or the eleventh: this opposition of the benefics could indeed produce marital difficulties and fights. The translation should read:

If Venus and Jupiter are <set> at the same time in the 5th place from the Horoscope or in the 11th, and no star aspects them from another portion, they decree difficult marriages or severe hostilities arising from the marriages, so that always entangled in furious disagreements, they keep on having quarrels of malicious hostility.

This description shows that even benefics in the fifth or the eleventh, if they are opposed, can bring about unpleasant situations.

Another passage in Book VI copies the astrological poet Anubio. Firmicus says:

If Mercury, the Moon and Venus together are located in the 11th from the Horoscopic place, and the sign [in the eleventh] is feminine, and Mars regards them with a trinal ray, they produce musicians, who always with sweet melody pluck the strings of the lyre or cithara.¹²³

121 It made no sense for it to be inserted in the first place. The two benefics are Venus and Jupiter; there is no 'third' benefic. It may be that what Firmicus meant by an aspect from another star was a 'good' aspect.

122 J. Firmicus Maternus, *Ancient Astrology: Theory and Practice, Matheseos Libri VIII by Firmicus Maternus*, trans. Jean Rhys Bram (Park Ridge, New Jersey: Noyes Press, 1975; reprint, Mansfield, Notts: Ascella, 1995), 212 (Ascella edition, 202); Monat, III, 89.

123 VI, 31.84 (KSZ, II, 172.3–7 = Monat, III, 109): 'Si in XI ab horoscopo loco Mercurius et Luna et Venus pariter fuerint collocati, et sit feminini generis signum, <et> Mars eos trigonica radiatione respiciat, musicos faciunt, qui lyrae vel citharae nervos dulci semper modulatione percutiant.' Note that the same word, *pariter*, is used here as it was in VI, 31.24—but without an opposite place (implying an opposition) being mentioned; here 'together in the same place' must be meant.

The Anubio fragment reads: ‘When the Glittering One [*Hermes*], the Moon and shapely Cytherea [*Aphrodite*] are [in] the zodiac sign of the Daimon, placed in a feminine sign . . . is in a trine, musicians . . .’¹²⁴ (Portions of Firmicus VI, 29, 30 and 31 also derive from this poem of Anubio.)¹²⁵

Book VII includes a section on violent deaths (correlated to much of Chapter 36 of the *Liber Hermetis*). Only when malefics are in the fifth or eleventh, in difficult aspect to other planets, do they bring about violent deaths.¹²⁶ The opposition of malefics in the eleventh and fifth is always unfortunate.¹²⁷

Finally, there is an interesting remark from Book VI:

But both the fifth and the eleventh places from the Horoscope, that is, Good Fortune <and Good Daemon>, differ from the inactive baseness of the idle places, nor are they joined in any association of ray [*aspect*] to idle and dejected places, but are united with the Horoscope in a happy association of ray.¹²⁸

This passage suggests some rationale for the goodness of the fifth and eleventh places beyond being in trine and sextile to the Ascendant. Neither is in a geometric relationship with the sixth and twelfth, the worst places in the chart. They are, of course, in square to the eighth, which is the ‘idle’ place *par excellence*. But perhaps it is enough for them to have no relationship with the sixth or twelfth (they are the only non-angular places to have no relationship with the sixth or twelfth).¹²⁹ Might this suggest that one of the things that makes a place ‘good’ is that it is not ‘contaminated’ by aspect to an unfortunate place? Could this even be one reason to make the fifth and eleventh places those of *Good Fortune* and *Good Daimon*? We normally think of the sixth

124 Anubio, 6 ii.41–44 (Obbink, 37): Στῖλβων καὶ Μήνη καὶ εὐεῖ|δῆς Κυ[θέρ]εῖα / Δαίμονος εἰνα[...].[. ζφ]δῖω ἰστᾶμ[εν]οῖ / θήλαε[ῖ] ἐν ζώω α[.....τ]ρῖγῶνος ὑπ[άρ]χη / μουσ[ο]υργοὶ χυ[.]

125 Ibid., 26–37.

126 See, e.g., Firmicus, VII, 23.7 (= *Liber Hermetis* 36.6, XXXVI.29–33 [Feraboli, 235]); Firmicus, VII, 23.14 (= *Liber Hermetis* 36.17, XXXVI.68–69 [Feraboli, 237]); Firmicus, VII, 23.16 (= *Liber Hermetis* 36.20, XXXVI.78–79 [Feraboli, 238]).

127 See Firmicus, VII, 23.17 (= *Liber Hermetis* 36.23, XXXVI.86–89 [Feraboli, p. 239]).

128 VI, 1.3 (KSZ, II, 67.14–19 = Monat, III, 2–3); ‘Sed et quintus et undecimus ab horoscopo locus, id est bonae fortunae <et boni daemones>, [signa] a pigrorum locorum inerti humilitate dissentiunt, nec cum pigris ac deiectis locis aliqua ra<dia>tionis societate <iunguntur, sed horoscopo felici societate radiationis> adsociantur.’

129 The first and seventh also have no relationship with the sixth and twelfth. The third and the ninth are the only places besides the first and seventh to have no relationship with the eighth; by the same reasoning, this may improve their standing.

being ‘improved’ by its trine to the tenth, as well as the second, but maybe the reverse was also true—a bad place can degrade a good place it aspects.

2.9 *Paulus Alexandrinus and Olympiodorus*

Both Paulus and his commentator, Olympiodorus, give traditional treatment to the fifth and eleventh places (see Appendix 2.B). The fifth, Good Fortune, delineates children and is a place where Aphrodite ‘rejoices more than all the [other] stars’.¹³⁰ Both authors agree that benefics give many children, but malefics are ‘destructive’ for them.¹³¹

In the Good Daimon place Zeus rejoices, and it is a place of ‘alliance and patronage’ and ‘good hopes’.¹³² The listings for the fifth place are quite short compared to the eleventh (and some other places). The fortune it gives seems to be just in children. (This may show the importance of having children in those times.) However, the fifth also mitigates the effect of malefics. The eleventh is one of the longest descriptions.¹³³ In terms of outcomes, it is almost as good as the tenth. In these place descriptions, the sect of some planets (Moon, Mars, Saturn) in relation to the sect of the chart is critical; if the sects align, all is well, but if not, the outcomes are bad. The exception seems to be Jupiter, which is good both by day and night. Mercury and Venus do not seem to be affected by sect, but only by aspects from malefics.

2.10 *Rhetorius*

At the end of the era of Hellenistic astrology is the early seventh century compiler Rhetorius. Again, like Valens and Firmicus, his work aims to be a complete manual for the practice of astrology. He is a main source for other, lost authors as well. His long section on the places takes up almost fifty pages

130 Paulus, ch. 24 (Boer, 57.7–9):...ὁ τῆς Ἀφροδίτης ἀστήρ παρὰ πάντας τοὺς ἀστέρας ἐν τούτῳ τῷ τόπῳ χαίρει. (See also Paulus, in *Late Classical Astrology: Paulus Alexandrinus and Olympiodorus with the Scholia from Later Commentators*, trans. and annot. Dorian Gieseler Greenbaum (Reston, VA: ARHAT, 2001), 46.)

131 Paulus, ch. 24 (Boer, 57. 10–13): ἐν δὲ τούτῳ τῷ ζῳδίῳ οἱ μὲν ἀγαθοποιοὶ χαίρουσι καὶ εὐτεκνίας διδῶσιν, οἱ δὲ κακοποιοὶ ἐν τούτῳ τῷ τόπῳ ἀναιρετικοὶ τέκνων γίνονται. (*Late Classical Astrology*, 46.) Olympiodorus, ch. 23 (Boer, 66.15–19): ἐπὶ πάντων οὖν ὁ τῆς Ἀφροδίτης ἀστήρ ἢ ἄλλος τις τῶν ἀγαθοποιῶν εὐρεθῆ ἢ ἐν αὐτῷ, εὐτεκνίας εἰσὶ δηλωτικοί. εἰ δὲ κακοποιὸς τις εὐρεθῆ ἢ ἐν αὐτῷ, οὐ τοσοῦτον μὲν ἐστὶ κακοποιὸς διὰ τὴν τοῦ τόπου ἀγαθότητα, ἀναιρετικὸς δὲ τέκνων γίνεται. (*Late Classical Astrology*, 113.)

132 Paulus ch. 24 (Boer, 68.6–10): ἐν γὰρ τούτῳ τῷ τόπῳ παρατυχῶν ὁ τοῦ Διὸς χαίρει παρὰ πάντας τοὺς ἀστέρας. σημαίνει δὲ τὸν περὶ συστάσεως καὶ προστασίας λόγον, πρὸς τούτοις δὲ καὶ ἀγαθῶν ἐλπίδων ἐστὶ σημαντικὸς. (*Late Classical Astrology*, 50.)

133 Other long ones are the 7th, 10th and, interestingly, the 12th.

in the *CCAG*.¹³⁴ Three pages are devoted to the fifth place, and about four to the eleventh. Unlike other authors, Rhetorius includes in his descriptions how to delineate the rulers of other places falling in a particular place. This is done in both directions: when the ruler of the place in question is in another place, and when the ruler of another place is in the place in question. For example (using the fifth place), Rhetorius says:

If the house-master of the 12th is in the 5th or 8th, or the lord of the 5th in the 12th, he will be a stepfather nurturing another's children. If the lord of the 5th or the lord of the Lot of Children is in the 8th, it makes those who are childless or those who bury their children.¹³⁵

Here reciprocal placements can delineate the same outcome (ruler of the twelfth in the fifth or ruler of the fifth in the twelfth both produce stepfathers). In addition, the lord of the fifth in a bad place like the eighth (death) causes childlessness or child mortality.

Rhetorius, like authors such as Valens, Firmicus, Paulus and Olympiodorus, also describes the effects of a particular planet in the place (he also includes the Nodes of the Moon). His delineations are similar to those of the others, in that benefics in good places bring good things, malefics in good places can be good or bad, and sect is always a factor. For example,

When the Moon happens to be in the zodiac signs of the Good Daimon by night, he [sc. the native] will come to be most gracious; for it makes leaders, the glorious, those placed in the front seats and inheriting good things from women, if she does not happen to be witnessed by Kronos and Ares. By day it brings about living abroad, shows plainly estrangements from women, separations or orphanhood, but as time goes by it will produce those who are happy.¹³⁶

134 A critical edition of Rhetorius, begun by David Pingree, is in preparation by Stephan Heilen: Rhetorius, *Compendium astrologicum secundum epitomen in cod. Paris. gr. 2425 servatam*, ed. David Pingree and Stephan Heilen, (Berlin/New York: De Gruyter, forthcoming). I refer to the *CCAG* pages here.

135 *CCAG* VIII/4, 152.24–27: 'Εάν δὲ ὁ οἰκοδεσπότης τοῦ ιβ' ἐν τῷ ε' ἢ ἡ' ἦ, ἢ ὁ κύριος τοῦ ε' ἐν τῷ ιβ', ἔσται πατρύϊος παιδῶν ἀλλοτριῶν τροφεύς· ἐάν δὲ ὁ κύριος τοῦ ε' ἢ ὁ κύριος τοῦ κλήρου τῶν τέκνων ἐν τῷ η' ἦ, ἀτέκνους ποιεῖ ἢ τέκνα θάπτοντας.

136 *CCAG* VIII/4, 174.12–17: 'Ἐν δὲ τοῖς ἀγαθοδαίμονοισι ζῶδιοις νυκτὸς τυχοῦσα ἡ Σελήνη πολυχαραριστάτη γενήσεται· ποιεῖ γὰρ ἡγεμόνας, ἐπιδόξους καὶ ἐπὶ προεδρίας τεταγμένους καὶ ἀπὸ γονέων τὰ ἀγαθὰ παραλαμβάνοντας, ἐάνπερ ἀκαταμαρτύρητος τύχη ὑπὸ Κρόνου καὶ Ἄρεως· ἡμερας δὲ ξενιτείας ἀποτελεῖ καὶ γονέων ἀλλοτριώσεις ἢ χωρισμούς ἢ ὀρφανίας προδηλοῖ· κατὰ δὲ πρόβασιν τοῦ χρόνου εὐδαίμονα γενήσκει.

Very good things come about when the planet is in sect and unaspected by malefics. By contrast, placements out of sect bring ‘growth opportunities’ that only provide eventual happiness after delays.

Rhetorius includes the eleventh’s connection with the ages of life, specifically the ‘third age of life, and it signifies reckoning about action, patronage and authority at the culmination of youth.’¹³⁷ In the standard doctrine the quadrant between the Ascendant and Midheaven represents the first quarter of life, youth (see, e.g., Manilius, Dorotheus, Paulus). Here the eleventh is the last (third) stage of youth before adulthood, assuming the first is birth and the twelfth is childhood. For Serapion, the eleventh is the last part of middle age, the ninth the first part and the Midheaven the middle of the life.¹³⁸

2.11 Conclusion

This overview has shown the general goodness of both the Good Daimon and Good Fortune places, along with evidence that the two were often considered as a pair (this is standard Hellenistic astrological procedure for each place and its diametrical opposite, and is also the case in Demotic astrology). Because of the cultural link already established between *daimōn* and *tuchē*, the astrological connection between them is both natural and reinforced. By knowing the cultural history of Daimon and Fortune, we gain insight into how past astrologers viewed these issues and, within astrological theory and practice, incorporated the way that Agathos Daimon and Agathe Tyche were employed in the religious and philosophical life of the Greco-Roman world.

This examination now provides a backdrop for the next chapter, which explores the Agathos Daimon, Agathe Tyche and their Egyptian equivalents in more depth. There are some interesting correlations between what astrologers do with Good Daimon and Fortune and with the way they are incorporated into the cultural and religious milieu of the Hellenistic and Roman periods. The concept of fate, in both Greek and Egyptian guise, will figure in this discussion. This will lead to some conclusions about why the Agathos Daimon and Agathe Tyche are used in astrological theory, technique and practice, and why studying the astrological practices of this time can aid in understanding some rather crucial philosophical and religious concepts which came to prominence in the period when astrology flourished.

137 CCAG VIII/4, 170.19–21: δηλοῖ δ’ ὁ ἰα’ τόπος καὶ τὴν τρίτην ἡλικίαν· σημαίνει δὲ καὶ περὶ πράξεως καὶ πατρωνίας καὶ προστασίας λόγον κατὰ τὴν ἀκμὴν τῆς νεότητος.

138 CCAG VIII/4, 231.26–28; see also Hübner, *Raum*, 125 and Diagram No. 13e; 305. Here the time correlations go in diurnal motion, not zodiacal as in Julian’s scheme.

Twists of Fate: Daimon, Fortune and Astrology in Egypt and the Near East

Look, your god has given one of your fates into your hand

THE TALE OF THE DOOMED PRINCE, 8.5¹

In the previous chapter, I began with Greece in my investigation of the cultural links between Daimon and Fortune, along with exploring the astrological places of Good Daimon and Good Fortune. But connections of Daimon and Fortune to other cultures in the Mediterranean world, particularly Egypt, Mesopotamia and other areas in the Near East are equally essential to the study of the daimon in astrology. This chapter will thus establish the religious and philosophical significance, and the relationship, between fortune and daimon in non-Greek cultures. In this context, concepts of fate other than the Greek will be investigated in terms of their effect on astrological theory and practice.

Our first task is to examine the cultural divinity Agathos Daimon as it exists in the late Hellenistic and Greco-Roman periods, especially in transition from Greece to Egypt. This will bring us to Alexandria and the presence of Agathos Daimon and Agathe Tyche in Egypt. This Egyptian entrée leads to the Agathos Daimon's connection to the Egyptian god Shai (who is associated with destiny), and thereby the role of fate as it relates to astrological theory and practice.

1 The Agathos Daimon and Agathe Tyche in Egypt (and Beyond)

In this section, we examine first the transition of Agathos Daimon and Agathe Tyche from Greece to Egypt, the connection of Agathos Daimon to the composite god Sarapis and the Egyptian deity Shai, and Agathe Tyche to Isis. Then, some Isis aretalogies important both for astrological components and

1 *ptr dī.w p3y=k ntr wꜥ m n3y=k š3y.w m dr.t=k* My transliteration of Gardiner's hieroglyphic transcription in A.H. Gardiner, *Late-Egyptian Stories* (Brussels: Édition de la Fondation égyptologique Reine Élisabeth, 1932), 'Doomed Prince', 8,5. Trans. M. Lichtheim, *Ancient Egyptian Literature: A Book of Readings*, vol. 11: The New Kingdom (Berkeley/Los Angeles/London: University of California Press, 1976), 202.

references to fate will be considered. The section ends with an excursus on Tyche at the Nabataean site of Khirbet et-Tannur.

1.1 *Sarapis and Isis: Agathos Daimon and Agathe Tyche*

When Alexander conquered Egypt in 331 BCE, and founded the city of Alexandria, he paved the way for the Ptolemaic dynasties in Egypt. With the entry of the Greeks into Egypt, cultural assimilations and accommodations began. One practice gave equivalent Greek names to Egyptian gods: e.g., Ptah became Hephaestus, Hathor Aphrodite, Amun Zeus, Isis Demeter, Horus Apollo, Osiris Dionysus, Set Typhon.² Another popularised Greco-Egyptian gods such as Sarapis.³ Sarapis is a composite of Osiris and the Apis bull and became popular as a cult figure among Greeks living in Alexandria. Because of his associations with Osiris, Sarapis's consort became Isis, and the two have much cult iconography in Greco-Roman Egypt. He is a god of the dead (like Osiris), but also a god of fertility, especially of the land; he often holds a cornucopia.⁴ His human-form iconography pictures him as a bearded, curly-haired man, wearing a *kalathos* (grain measure) on his head, accompanied by vegetal symbols of fertility.⁵ Macrobius associates him with the sun (*Saturnalia*, I, 20.13–15), and Sarapis and Isis are called Helios and Selene in an Isis aretalogy.⁶ Like Asclepius, Sarapis becomes connected with healing, and has sanctuaries for incubation cures.⁷

2 F. Dunand and C. Zivie-Coche, *Gods and Men in Egypt: 3000 BCE to 395 CE*, trans. David Lorton (Ithaca, NY: Cornell University Press, 2004), 241–42, citing Herodotus, *Histories*, II, 42 and 156 (but see also II 3, 50, 59, 144). Plutarch, *De Iside et Osiride*, 362, also mentions the Egyptian-Greek correlation of names.

3 For the cult of Sarapis (and Isis) at Alexandria, see Fraser, *Ptolemaic Alexandria*, I, 246–76. See also Dunand's discussion in Dunand and Zivie-Coche, *Gods and Men*, 214–21; R. Merkelbach, *Isis regina—Zeus Sarapis. Die griechisch-ägyptische Religion nach den Quellen dargestellt* (Stuttgart/Leipzig: B. G. Teubner, 1995), 59–86, 121–30 (Erster Teil.4, 5, 10). Historical sources for Sarapis may be found in Plutarch, *De Iside et Osiride*, 361f–362d (origins and characteristics); Tacitus, *Histories*, 4, 83–84 (Wellesley, 166–67) (origins); Artemidorus, *Oneirocritica* 2, 39 (Pack, 175) and 5, 92–94 (Pack, 324) (Sarapis in dreams); Strabo, *Geography*, 17, I, 17 (Meineke, III, 116–17) (temple and incubation cures); Diogenes Laertius, *Lives of the Philosophers*, 5, 76 (Marcovich, I, 361) (cure by Sarapis).

4 Dunand and Zivie-Coche, *Gods and Men*, 218.

5 See *LIMC*, VII/2 (plates), 504–18, s.v. 'Sarapis'.

6 G. Sfameni Gasparro, 'The Hellenistic Face of Isis: Cosmic and Saviour Goddess', in *Nile into Tiber: Egypt in the Roman World*, ed. Laurent Bricault, Miguel John Versluys, and Paul G. P. Meyboom, *Religions in the Graeco-Roman World* (Leiden/Boston: Brill, 2007), 41 and n. 4.

7 Dunand and Zivie-Coche, *Gods and Men*, 218.

For the Greeks, it was important to have a *polis* god. In the Roman period, Sarapis became the special patron god of Alexandria; in *The Potter's Oracle*, Agathos Daimon is associated with this city even earlier (see 1.2 below). Sarapis may even link to the Agathos Daimon because of that deity's association with Alexandria.⁸

The Ptolemies made much of the new deity; Ptolemy III built a Sarapeum at Alexandria, and Sarapis and Isis were featured on coins.⁹ With Isis and Sarapis the Greek Ptolemies could acquire a little Egyptian patina. But except for Memphis, where the cult of Sarapis was more attuned to the original Egyptian 'Osor-Hapi' (*Wsir-Hp*),¹⁰ the native Egyptians do not appear to have embraced the new cult of Sarapis.¹¹

In addition, Sarapis and Isis are linked to the names Agathos Daimon and Agathe Tyche. They often appear in snake form, and sometimes their iconography merges; there are instances of snakes with Sarapis (or Agathos Daimon?) heads as well as snakes with Isis heads.¹² The snake motif in these Greco-Egyptian representations arises from ties to the Egyptian deities Shai (god of 'fate'; see below, 1.2, 2.1 and 2.5) and Renenet (goddess of nourishment; see 2.2), who can be represented in this guise. In iconography, as Françoise Dunand's studies show, Agathos Daimon is often pictured with Thermonthis (Agathe Tyche).¹³ Often the two deities are pictured together, as a couple, and worshipped at the same shrine. This is true both in Greece and in Egypt. It is sometimes difficult to distinguish which syncretic deity—Shai/Agathos

8 M. Pietrzykowski, 'Sarapis—Agathos Daimon', in *Hommages à Maarten J. Vermaseren*, 3 vols., vol. III, ed. Margreet B. de Boer and T. A. Eldridge, *Études préliminaires aux religions orientales dans l'Empire romain* (Leiden: E. J. Brill, 1978), 963–66; for p. 963, explaining why Sarapis is identified with Agathos Daimon, cf. Fraser, *Ptolemaic Alexandria*, I, 209–10.

9 Dunand and Zivie-Coche, *Gods and Men*, 218; see also F. Dunand, 'Les représentations de l'Agathodémon à propos de quelques bas-reliefs du Musée d'Alexandrie', *BIFAO* 67 (1969): 9–48, here 26–30.

10 Dunand and Zivie-Coche, *Gods and Men*, 215; I. S. Moyer, *Egypt and the Limits of Hellenism* (Cambridge/New York: Cambridge University Press, 2011), 147–51; see also Fraser, *Ptolemaic Alexandria*, I, 255.

11 Dunand and Zivie-Coche, *Gods and Men*, 220; see also G. Fowden, *The Egyptian Hermes: A Historical Approach to the Late Pagan Mind* (Princeton: Princeton University Press, 1986, repr. 1993), 19 and n. 34, which details the extent of 'Hellenisation' of the native Egyptians.

12 Pietrzykowski, 'Sarapis—Agathos Daimon', 960–61.

13 Dunand, 'Agathodémon'; see also F. Dunand, 'Agathodaimon', in *LIMC*, vol. 1/1 (Zurich/Munich: Artemis Verlag, 1981), 277–82; 1/2, 203–06.

Daimon/Sarapis, or Renenet/Thermouthis/Isis/Agathe Tyche—is meant to be represented in the iconography.¹⁴ Suggestions of all of them may be implied.

In Alexandria, shrines to both Agathos Daimon and Agathe Tyche have been found (either actual remains or historical evidence of them). In the case of the Agathos Daimon, some Alexandrian coins from the times of Hadrian to Antoninus Pius depict an altar,¹⁵ which Susan Handler, accepting the proposal of J. Vogt, believes is the altar of Agathos Daimon supposedly erected by Alexander when he founded the city¹⁶ (Figure 3.1).

The coin, Handler says, ‘depicts an *agathos daimon* serpent wearing a skhent on one side of the altar, with a uraeus serpent wearing a two-horned sun disk on the other.’¹⁷ It is hard to see the headdresses in the photograph, but surely this is a representation not just of Agathos Daimon/(Shai), but also his companion Isis/Thermouthis/(Agathe Tyche).¹⁸

-
- 14 E.g., image 123 (Sarapis), *LIMC* VII/2, 511 = image 3 (Agathodaimon), *LIMC* I/2, 203; often the images and descriptions in Dunand, ‘Agathodémon’ are labelled ‘Isis-Thermouthis’, ‘Sarapis-Agathodémon’; see also the various syncretisms given in *LIMC*, I/2, 277. For an in-depth survey of the connections among these deities iconographically and religiously, see Barrett, *Egyptianizing Figurines*, 221–44.
- 15 Coins with similar images: G. Dattari, *Numi Augg. Alexandrini. Catalogo della collezione G. Dattari*, 2 vols. (Cairo: Tipographia dell’istituto francese d’archeologia orientale, 1901), nos. 3000–3009 (no. 3004 is said to have ‘due serpenti’ on either side of the pyre on the architrave); J. Vogt, *Die alexandrinischen Münzen. Grundlegung einer alexandrinischen Kaisergeschichte*, 2 vols in 1 (Stuttgart: W. Kohlhammer Verlag, 1924), Pl. III, nos. 1–9; J. G. Milne, *A Catalogue of Alexandrian Coins in the Ashmolean Museum* (Oxford: Oxford University Press, 1933), 51, nos. 2158–2165 and Plate I (2158, 2160), called ‘Altar of the Caesareum’. The recently updated Dattari includes rubbings of many coins previously not pictured: see A. Savio, ed., *Numi Augg. Alexandrini. Catalogo della collezione Dattari* (Trieste: Giulio Bernardi Editore, 2007), 157–58, nos. 3000–3013, all with images of this altar/temple. Unfortunately the images are of poor quality. See also S.-A. Ashton, *Roman Egyptomania* (London: Golden House Publications, 2004), 46–47, no. 24 (labelled ‘Altar of the Caesareum’); J. McKenzie, *The Architecture of Alexandria and Egypt 300 BC–AD 700* (New Haven: Yale University Press, 2007), 187–88, n. 105 and fig. 328, is doubtful of a secure attribution for the altar/temple.
- 16 Vogt, *Münzen*, 106–08; S. Handler, ‘Architecture on the Roman Coins of Alexandria’, *AJA* 75, no. 1 (1971): 57–74, here 68–69. See the discussion of Ps.-Callisthenes below, 85.
- 17 Handler, ‘Architecture on Roman Coins’, 68. She follows Dattari’s description (Dattari, I, 196, no. 3006): ‘... agll’angoli della base, due figure (?); a s. dell’altare, agathodaemon eretto a d., porta skhent; alla d., Uraeus eretta a s., porta un disco tra due corna’.
- 18 Handler does not mention Agathe Tyche. Vogt, *Münzen*, 108 also made this proposal, which I arrived at independently before I saw Vogt.



FIGURE 3.1
 Coin from Alexandria representing an
 Altar (perhaps to Agathos Daimon),
 with snakes on either side.¹⁹

Other representations have similar motifs.²⁰ For example, two limestone reliefs now in Alexandria portray the same pair, as snakes, in like fashion. No. 3179 (Figure 3.2, left) shows Isis/Thermouthis on the left, wearing the Isis crown and Agathos Daimon/Shai on the right, wearing the crown of Lower Egypt, facing each other across an altar.²¹ No. 3180 (Figure 3.2, right) depicts Agathos Daimon on the left wearing the double crown and Isis/Thermouthis facing him on the right, wearing the Isis crown, both surrounding Demeter. Behind Agathos Daimon is a caduceus, behind Isis a sistrum.²²

19 Bronze, Antoninus Pius, Year 23, reverse. Image by permission of bpk, Berlin/Staatliche Museen (Munzkabinett)/Reinhard Saczewski/Art Resource, NY. Earlier reproduced in Vogt, *Münzen*, Plate III, no. 8 (= Dattari 3006, rubbing in Savio, *Catalogo Dattari*, 157); Handler, 'Architecture', 68–69 and Plate 12:21.

20 E.g., see *LIMC*, 1/2, s.v. 'Agathodaimon', 204, nos. 10, 13; 205, nos. 14, 17 and 20. See also Barrett, *Egyptianizing Figurines*, 225–27.

21 Photograph courtesy of the Greco-Roman Museum, Alexandria and Curator Hagar Abdelgawad. Image also in *LIMC*, 1/2, s.v. 'Agathodaimon', 205, no. 17. See also Dunand, 'Agathodémon', 12 (no. 5) and Pl. II.B.

22 Photograph courtesy of the Greco-Roman Museum, Alexandria and Curator Hagar Abdelgawad. Image also in *LIMC*, 1/2, s.v. 'Agathodaimon', 205, no. 20. See also Dunand, 'Agathodémon', 13 (no. 8) and Pl. III.A.



No. 3179



No. 3180

FIGURE 3.2 Limestone reliefs depicting *Agathos Daimon* and *Isis/Thermouthis*. Graeco-Roman Museum, Alexandria. Used with permission of the Minister of Antiquities, Egypt.

The tentacles of this pairing, and resultant cults, insinuate themselves into the Egypto-Greco-Roman world. From the late Hellenistic (ca. 166 BCE), a cult to Agathe Tyche, as well as Sarapeia and dedications to the Agathos Daimon, existed on Delos.²³ Similar cults arose in Alexandria.²⁴ Just as Sarapis becomes the *polis* god of Alexandria, Agathe Tyche too is an important *polis* goddess (famously, e.g., in Antioch).²⁵ On the political and religious front, Ptolemaic queens have associations with both Agathe Tyche and Isis.²⁶ Oaths are sworn by the Daimon (= Demotic Pshai) of the Ptolemies.²⁷ The relationship between the Agathos Daimon and Shai forms a significant part of this complex.

1.2 *The Agathos Daimon and Shai*

In the Ptolemaic period, the name of the Agathos Daimon arrived in Egypt. But is this deity based on the Greek concept of the Agathos Daimon, which had been known since the fourth century BCE in Greece, or does it assimilate

23 Moyer, *Egypt and the Limits of Hellenism*, 142–43; Fraser, *Ptolemaic Alexandria*, 1, 241, 243; Barrett, *Egyptianizing Figurines*, 4, n. 9; 223, 244–46.

24 Fraser, *Ptolemaic Alexandria*, 1, 209, 241–42. The Tychaion in Alexandria is described by (Pseudo)-Libanius, *Descriptiones*, 12.25; see Visser, *Götter und Kulte*, 99, for this text. See also Sfameni Gasparro, '*Daimôn* and *Tuchê*', 85, for temples to Tyche in those places and other evidence in Troezen, Thera and Syracuse.

25 The Tyche of Antioch was world-renowned. See Arya, 'Goddess Fortuna', 35–36, 38.

26 Fraser, *Ptolemaic Alexandria*, 1, 240–41; Barrett, *Egyptianizing Figurines*, 190–98.

27 R. Beare, 'Ptolemy's Daimon and Ruler-Cult', *Klio* 62, no. 2 (1980): 327–30.

the Egyptian concepts of the deity known as Shai?²⁸ Certainly similarities exist between the two, as Jan Quaegebeur showed.²⁹ Both are seen as protective deities. Both have a connection with snakes. They both become local and personal protectors of a house or place (as the Roman *genius*). Most important, perhaps, are their links with ideas of destiny; but Greek conceptions of fate are not the same as Egyptian ones, as we will see below.

The Agathos Daimon makes a famous appearance in *The Potter's Oracle*.³⁰ This late tale falls in the genre of apocalyptic literature, to which parts of the Hermetic *Asclepius* bear a strong resemblance.³¹ Only a Greek version, in second and third century CE papyri, exists, but internal allusions date it to ca. 130 BCE.³² It tells of the prophecy of a potter concerning the destruction of Alexandria, and the return of its Agathos Daimon to Memphis (its outlook is strongly anti-Greek). The relevant passages read:

And the belt-wearers [*the Greeks*] will destroy themselves, for they are followers of Typhon. Then Agathos Daimon will abandon the city that is being built [*i.e. Alexandria*] and will emigrate to god-bearing Memphis. . . . the city by the sea will be transformed into a drying-place

28 We explore his attributes more fully below, in 4.1.

29 Quaegebeur, *Shai*, 171. In the following discussions, I depend on the work of Quaegebeur, whose monograph on Shai remains the standard in the field.

30 The critical edition, combining three papyri (P. Graf G. 29787, P. Rainer G. 19 813; P. Oxy. 2332), is L. Koenen, 'Die Prophezeiungen des "Töpfers"', *ZPE* 2 (1968): 178–209. English translations by S. M. Burstein, ed. and trans., *The Hellenistic age from the battle of Ipsos to the death of Kleopatra VII* (Cambridge: Cambridge University Press, 1985), 136–39; A. Kerkeslager, 'The Apology of the Potter: A Translation of the Potter's Oracle', in *Jerusalem studies in Egyptology*, ed. Irene Shirun-Grumach, *Ägypten und Altes Testament*, Bd. 40 (Wiesbaden: Harrassowitz, 1998), 67–79; B. O'Connell, 'The Potter's Oracle', *Ancient Society: Resources for Teachers* 13.3 (1983): 151–60 (*non vidit*). On the genre of Egyptian apocalyptic literature, see A. Blasius and B. U. Schipper, eds., *Apokalyptik und Ägypten: eine kritische Analyse der relevanten Texte aus dem griechisch-römischen Ägypten*, vol. 107, OLA (Leuven/Paris/Sterling, VA: Peeters, 2002); thanks to the anonymous reader for this citation.

31 I.e., 24–26; see *Hermetica*, trans. and comm. Brian P. Copenhaver (Cambridge: Cambridge University Press, 1992, repr. 2000), 239, notes to p. 81 (and bibliography).

32 See L. Koenen, 'A Supplementary Note on the Date of the Oracle of the Potter', *Zeitschrift für Papyrologie und Epigraphik* 54 (1984): 9–13; and idem, 'Die Apologie des Töpfers an König Amenophis oder das Töpferorakel', in *Apokalyptik und Ägypten: eine kritische Analyse der relevanten Texte aus dem griechisch-römischen Ägypten*, ed. A. Blasius and B. U. Schipper, OLA (Leuven/Paris/Sterling, VA: Peeters, 2002), 139.

for fishermen, for Agathos Daimon and Mephis/Knephis³³ will have departed to Memphis, so that passers-by will say: ‘This was [once] the all-nurturing city, that was inhabited by all races of men.’³⁴

In this anti-Greek polemic the Greek names of the gods actually represent their Egyptian equivalents (i.e., Agathos Daimon for Shai, Typhon for Set). The passage harks back to a better time, when the gods of Egypt had not gone to protect a foreign-founded city. It contrasts the ‘upstart’ Alexandria with Memphis, one of the oldest Egyptian cities. It shows the importance of the god to the city’s prosperity: it was not unusual for a city to have a guardian daimon in this period. Even putting aside which possible meanings and associations to apply to the Egyptian Agathos Daimon here,³⁵ we still see acknowledged the magnitude of its power, as the guardian god of the city. The departure of the city’s god seals the fate of the city to wither into obscurity. The abandonment of the city’s personal daimon is the kiss of death.

The Potter’s Oracle seemingly implies that the (Greek) Agathos Daimon came to Egypt with the founding of Alexandria, and some scholars assert that

33 P₂ (P. Rainer col. II, 36) has Κνηφιν, followed by some translators (Fowden, *The Egyptian Hermes*, 21; Burstein, *Hellenistic age*, 137 and n. 15 [p. 138]); but the text of P₃ (P. Oxy., col. II, 60) reads Μῆφιν. Knephis (Kematef) is an Egyptian snake-god. J. Bergman, *Ich bin Isis: Studien zum memphitischen Hintergrund der griechischen Isisaretalogien* (Uppsala: 1968), says, 62 n. 3 (citing H. Bonnet, *Reallexikon der ägyptischen Religionsgeschichte* (Berlin: De Gruyter, 1952), s.v. Kneph, 378–79), that Knephis is a well-known Late Period name of Amun. For more on Knephis/Kematef, see H. J. Thissen, ‘ΚΜΗΦ—Ein verkannter Gott’, *ZPE* 112 (1996): 153–60.

34 *The Potter’s Oracle*, this version P₃ (from P. Oxy. 2332, dated ca. 116 BCE by Koenen), 49–52, 58–62, as quoted in Fowden, *The Egyptian Hermes*, 21–22 (the Greek from Koenen, ‘Die Prophezeiungen des “Töpfers”’, 205, 207: καὶ ἑαυτοὺς οἱ ζωνοφόροι ἀνελοῦσι<ν> ὄντες καὶ αὐτοὶ Τυφώνιοι. καὶ τότε ὁ Ἄγαθος Δαίμων καταλείψει τὴν κτιζομένην πόλιν καὶ ἀπελεύσεται εἰς τὴν θεοτόκον Μέμφιν ἢ τε παρθαλάσσιος πόλις φυγμ<ός> ἀλιέων ἔσται διὰ <τὸ> τὸν Ἄγαθὸν Δαίμονα καὶ Μῆφιν <εἰς Μέμφιν> πορεύεσθαι, ὥστε τινὰς διερχομένους λέγειν ‘αὕτη ἦν ἡ παντοτρόφος, {εἰς} ἣν κατοικεῖ πᾶν γένος ἀνδρῶν.’). Burstein, *Hellenistic age*, 138, n. 10, says ‘The “Good Daimon”, the patron god of Alexandria . . . was identified with Shay, the Egyptian god of fate.’

35 E.g., to Shai as the personification of destiny, as well as other associations to gods such as Horus, Osiris, Ra and Thoth: see Quaegebeur, *Shai*, 102, 175. At Medinet Mâdi and in Hymns II, 9 and IV, 5 of the Isis hymns of Isidorus found there, Agathos Daimon is matched to Sokonopis (see V. F. Vanderlip, *The Four Greek Hymns of Isidorus and the Cult of Isis* (Toronto: A. M. Hakkert Ltd., 1972), 35, 38–39).

Alexander brought the god from Macedonia with him.³⁶ In the *Alexander Romance* of Pseudo-Callisthenes, Alexander's heritage is linked with snakes; when a snake is killed during the building of Alexandria, he sets up a shrine to it in the form of the Agathos Daimon. The indigenous, harmless snakes there were revered as incarnations of the great snake represented by the Agathos Daimon.³⁷ Yet there is evidence of genuine Egyptian (Demotic) roots in the *Alexander Romance*, at least in the Nectanebo material.³⁸ And outside of the *Alexander Romance*, Quaegebeur has demonstrated that, in fact, the way that Agathos Daimon was employed in the Greco-Roman texts and iconography reveals its faithfulness to Egyptian roots, particularly to Shai.³⁹ Quaegebeur has made a good case for proposing that the equation of Shai to the Agathos Daimon was founded not on applying Greek characteristics to the Egyptian God, but the other way around: Shai gave his features to the Agathos Daimon.

If, then, 'Agathos Daimon' just translated 'Shai' for the inhabitants of Ptolemaic and Roman Egypt, and was not meant to signify a wholesale transference of the Greek concept of the Agathos Daimon into Alexandrian Egypt,⁴⁰ this provides some help in teasing out the development of the fate concepts associated with the later Agathos Daimon in Roman Egypt. In other words, Egyptian concepts of fate may have influenced the way the (*agathos*) *daimōn* was perceived in the later period, in areas outside Greece proper. This in turn aids in understanding the astrological *daimon* and its relationship to fate and providence. The ideas associated with Shai in Egyptian culture and

36 E.g., A. Bernand, *Le Delta égyptien d'après les textes grecs*, vol. 1, *Les confins libyques* (Cairo: Institut français d'archéologie orientale, 1970), quoted in Quaegebeur, *Shai*, 173; Visser, *Götter und Kulte* (quoted by Quaegebeur as Elisabeth Visser), 174, claims that the Agathos Daimon is one of the 'zum griechischen Kultus gehörenden Göttern'. But contrast, e.g., among others, Koenen, 'Die Apologie des Töpfers', 144 and n. 45, 165–66; Barrett, *Egyptianizing Figurines*, 243, n. 902.

37 Pseudo-Callisthenes, *Historia Alexandri Magni*, ed. Wilhelm Kroll, (Berlin: Weidmann, 1926), I, 32.6–13. An English translation from Armenian, containing a similar version, is Pseudo-Callisthenes, *The Romance of Alexander the Great*, trans. A. M. Wolohojian (New York/London: Columbia University Press, 1969), 51, sections 86–87. Stoneman, in *The Greek Alexander Romance*, trans. R. Stoneman (London: Penguin Books, 1991), substitutes a different text for I, 32.6–7, omitting the serpent and mention of the Agathos Daimon.

38 R. Jasnow, 'The Greek Alexander Romance and Demotic Egyptian Literature', *JNES* 56, no. 2 (1997): 95–103, esp. 98–101.

39 Quaegebeur, *Shai*, 170–76. F. Dunand, 'Agathodaimon', 280–82, also suggested that the snake formation of the Agathodaimon is due to its Egyptian influence, pointing out that many Greek images of the Agathos Daimon show him in the form of a bearded man (perhaps linking him to Zeus Ktesios; see Chapter 2, 2.1).

40 Quaegebeur, *Shai*, 174–75.



FIGURE 3.3 *Roman coin, ca. 76 CE, reverse, depicting the Agathos Daimon wearing the skhent (double) crown, with caduceus (left) and wheat ear (right).*⁴¹

religion transfer into the translated and metamorphosed version of the Agathos Daimon in the Roman period, just at the time when Hellenistic astrology was making its mark in the Mediterranean world of the first and second centuries CE. There is a significant relationship between Shai and Egyptian concepts of fate which we shall explore below (2.1 and 2.5). Isis is linked to Tyche and to fate as well.⁴² In a set of hymns to Isis, composed in the first century BCE, she is portrayed both as Tyche and as a ‘mistress of fate’.

1.3 *Isis, Agathe Tyche and Fate*

The Isis hymns, found in a number of variants, are commonly known as ‘aretagologies’.⁴³ They are extant only in Greek versions, but scholars have persuasively

41 Billon tetradrachm, Alexandria, Egypt, ca. 76 CE (Year 1 of Nerva). From the author’s collection. I thank Alex Morley-Smith, Roma Numismatics, London, for the image. See Dunand, ‘Agathodémon’, here 28 and n. 1 (on coins, Agathos Daimon with ‘couronne, caducée et épis’). See also an example in Ashton, *Roman Egyptomania*, 92–93, no. 55; Harrison, *Themis*, 278, fig. 67.

42 Fraser, *Ptolemaic Alexandria*, I, 243–44; Dunand and Zivie-Coche, *Gods and Men*, 275.

43 See the list in Y. Grandjean, *Une nouvelle arétalogie d’Isis à Maronée* (Leiden: E.J. Brill, 1975), 8–11 (including one in Diodorus Siculus, *Bibliotheca historica* I, 27.4; one by Isidorus;

argued for their Egyptian inspiration at the very least, if not more tangible parallels.⁴⁴ Two of them, Isidorus and Kyme, will be exemplars in this discussion. The aretalogy composed by Isidorus, in four parts, was found at Medînet Mâdi (ancient Narmouthis, where there was a temple to Thermouthis/Renenet) in 1935.⁴⁵ This in itself is significant because it shows the assimilation of Isis to Renenet under her Greek name of Thermouthis.⁴⁶ In fact, one part of Isidorus's paeon in Greek emphasises Isis as a universal goddess, identified with goddesses of neighbouring Mediterranean cultures:

Thracians, Greeks and foreigners
 Speak your beautiful name, most honored by all,
 Each in his own tongue, in his own land.
 The Syrians call you Astarte, Artemis, Nanaia;
 The Lycian tribes Queen Leto;
 Thracians call you Mother of the gods,

and those at Maroneia, Andros, Kyme, Salonika and Ios). M. Totti, *Ausgewählte Texte der Isis- und Sarapis-Religion* (Hildesheim/Zurich/New York: Georg Olms Verlag, 1985) has gathered variants in a critical edition (nos. 1–6).

- 44 The main proponents are R. Harder, *Karpokrates von Chalkis und die memphitische Isispropaganda*, vol. 14 (Berlin: De Gruyter, 1943 [1944]); Bergman, *Ich bin Isis*; Vanderlip, *Hymns of Isidorus*; Grandjean, *Nouvelle arétalogie*; T. M. Dousa, 'Imagining Isis: On Some Continuities and Discontinuities in the Image of Isis in Greek Isis Hymns and Demotic Texts', in *Acts of the Seventh International Conference of Demotic Studies, Copenhagen, 23–27 August 1999*, ed. Kim Ryholt (Copenhagen: Museum Tusulanum Press, 2002); and, most recently, J. F. Quack, '“Ich bin Isis, die Herrin der beiden Länder” Versuch zum demotischen Hintergrund der memphitischen Isisaretalogie', in *Egypt—Temple of the Whole World. Ägypten—Tempel der gesamten Welt. Studies in Honour of Jan Assmann*, ed. Sibylle Meyer (Leiden/Boston: Brill, 2003), who has not only pointed out many Egyptian examples but has created a hypothetical Demotic version based on them (I thank the anonymous reader for this reference). D. Müller, *Ägypten und die griechischen Isis-Aretalogien* (Berlin: Akademie-Verlag, 1961) supplies many Egyptian parallels coordinated with the Greek, though he ultimately supports more Greek influence (see his p. 87). For a history of the Egyptian vs. Greek origins of the text, see the excellent summaries of H. S. Versnel, *Inconsistencies in Greek and Roman Religion 1. Ter Unus: Isis, Dionysos, Hermes: Three Studies in Henotheism* (Leiden/New York/Copenhagen: E.J. Brill, 1990), 41–44; and Dousa, 'Imagining Isis', 151 and n. 9.
- 45 Vanderlip, *Hymns of Isidorus*, 9. J. Broekhuis, *De godin Renenwetet* (Assen: Van Gorcum, 1971) (see esp. ch. 6), has studied these poems, pointing out the connections between Thermouthis and Isis; see also Sfameni Gasparro, 'Hellenistic Face of Isis', 49–57.
- 46 Or Hermouthis, the 't' representing the Egyptian feminine definite article.

The Greeks Great-throned Hera and Aphrodite,
And good Hestia, Rhea, Demeter. . . .⁴⁷

More importantly for our purposes, three of Isidorus's four hymns begin by stressing Isis's identifications with wealth, with Hermouthis and with Agathe Tyche, bestower of Fortune.

Wealth-giver, Queen of the gods, Queen Hermouthis,
Almighty, Agathe Tyche, renowned Isis,
Most exalted Deo, inventor of all life. . . .⁴⁸

The goddess is personified Good Fortune, bestowing wealth and life. This correlates well with the astrological qualities of the fifth place, *Agathē Tychē*, the place of children and general good fortune, and with the Lot of Fortune, which can symbolise the literal gaining of fortune (among other things). Isis is identified in other texts with Shepset,⁴⁹ the goddess of riches and wealth whom we met in Chapter Two (and see below, 2.3).

47 Isidorus, *Hymn* 1.15–22 (Vanderlip, 17; Bernand, 632 [É. Bernand, *Inscriptions métriques de l'Égypte gréco-romaine. Recherches sur la poésie épigrammatique des grecs en Égypte* (Paris: Les Belles Lettres, 1969)]): Θρῆκες και Ἐλληνες, και ὅσσοι βάρβαροί εἰσι, / οὐνομά σου τὸ καλόν, πολυτίμητον παρὰ πᾶσι, / φωναίσι φράζουσι ἰδίαις, ἰδίαι ἐνὶ πάτρῃι. / Ἀστάρτην Ἄρτεμιν σε Σύροι κλήζουσι Ναναίαν / και Λυκίων ἔθνη Λητοῦν καλέουσιν ἄνασ<σαν> / Μητέρα δὴ κλήζουσι θεῶν και Θρηίκες ἄνδρες, / Ἐλληνες δ' Ἥρην μεγαλόθρονον ἢδ' Ἀφροδίτη<ν> / και Ἔστῖαν ἀγαθὴν, και Ῥεῖαν, και Δήμητρα. . . . On Isis's universality see H. Kockelmann, *Praising the Goddess: A Comparative and Annotated Re-Edition of Six Demotic Hymns and Praises Addressed to Isis* (Berlin/New York: Walter De Gruyter, 2008), 54–59; J. D. Ray, *The Archive of Ḥor* (London: Egypt Exploration Society, 1976), 156; Sfameni Gasparro, 'Hellenistic Face of Isis', 54–56; Barrett, *Egyptianizing Figurines*, 129, n. 410.

48 Hymn 1.1–3 (Vanderlip, 17; Bernand, 632): πλουτοδότι βασιλεια θεῶν, Ἐρμούθῃ ἄνασσα, / παντοκράτειρα, τύχη Ἀγαθὴ, μεγαλώνυμε Ἴσι, / Διοὶ ὑψίστη, ζωῆς εὐρέτρια πάσης. . . . Hymn II begins: χαῖρε, Τύχη Ἀγαθὴ, μεγαλώνυμε Ἴσι μεγίστη, / Ἐρμούθῃ. . . (II.1–2 [Vanderlip, 34; Bernand, 633]). Hymn III mentions Hermouthis in l. 1 and Agathe Tyche in l. 19, at a change of tone when Isidorus says 'Hear me, Agathe Tyche. . .' (Vanderlip, 49–50; Bernand, 634).

49 See Dousa, 'Imagining Isis', 179 and nn. 124, 126; e.g., in O. Hor 10.8–9 she is '... great goddess, lady of love(?), Shepset, great Shai, . . . t3 ntr.t '3.t nb.t mr.t(?) t3 šp3.yt p3 šy '3 (Dousa cites Ray, *Archive of Ḥor*, 46–47, but gives the wrong line numbers in his quotation). My translation, following the transliteration of Kockelmann, *Praising the Goddess*, 11 (taking Shepset and Shai as divinities because of the definite article, acc. Hughes, 'A Demotic Plea to Thoth', 179; and F. T. Miosi, 'God, Fate and Free Will in Egyptian Wisdom Literature', in *Studies in Philology in Honour of Ronald James Williams: A Festschrift*, vol. 3, SSEA Publications, ed. Gerald E. Kadish and Geoffrey E. Freeman (Toronto: Benben

The Kyme variant of the Isis hymns, from Aeolis (Asia Minor) (see Appendix 3.A), written in the first person, treats Isis as a chief of the pantheon of Egyptian gods, responsible for much of what makes up the physical world in addition to its cultural and ethical values. She has intriguing astrological/astronomical and cosmological links:

I am she who arises in the Dog-Star... I who separated earth from heaven... I pointed out the paths of the stars, / I arranged the courses of the sun and moon... I am in the rays of the sun / I accompany the course of the sun...⁵⁰

The heliacal rising of Sirius (the Dog-Star) marks the beginning of the Egyptian year, and Isis is famously associated with *Spdt* (the Egyptian name for Sirius; the Greek form is Sothis).⁵¹ On O. Hor 3.3–5 *recto*, Isis opens the Pharaoh's own new year (birthday) with favourable *šzy* and *špšyt* (see n. 118; also Chapter Two, 2.2).⁵² Jan Bergman points out that the word 'arises', ἐπιτέλλω in Greek, can mean both 'command' and have the technical meaning of 'heliacally rise'.⁵³ (Isis, as the heliacally-rising Sirius, has commanded the year to begin.) These astronomical links connect Isis intimately with time, and particularly with the solar cycle. Further analysis of Isis and time is not necessarily relevant here,⁵⁴

Publications, 1982), 110, n. 68). See also J. F. Quack, 'Zu einer angeblich apokalyptischen Passage in den Ostraka des Hor', in *Apokalyptik und Ägypten. Eine kritische Analyse der relevanten Texte aus dem griechisch-römischen Ägypten*, ed. A. Blasius and B. U. Schipper, *Orientalia Lovaniensia Analecta* (Leuven/Paris/Sterling, VA: Peeters, 2002), 245.

50 Vanderlip, *Hymns of Isidorus*, Plate xv: 9 Ἐγὼ εἰμι ἡ ἐν τῷ τοῦ Κυνοῦ ἀστρῶ ἐπιτέλλουσα. . . 12 ἐγὼ ἐχώρισα γῆν ἀπ' οὐρανοῦ. 13 ἐγὼ ἀστρῶν ὁδοὺς ἔδειξα, 14 ἐγὼ ἡλίου καὶ σελήνης πορείαν συνεταξάμην. . . 44 ἐγὼ ἐν ταῖς τοῦ ἡλίου ἀυγαῖς εἰμι, 45 ἐγὼ παρεδρεύω τῇ τοῦ ἡλίου πορείᾳ.

51 See e.g., Müller, *Isis-Aretalogien*, 34 and n. 1; S. Morenz, *Egyptian Religion*, trans. Ann E. Keep (London: Methuen & Co. Ltd., 1973), 270; A. S. Mercatante, *Who's Who in Egyptian Mythology* (New York: Clarkson N. Potter, Inc., 1978), 75. G. Thausing, 'Der ägyptische Schicksalsbegriff', *MDAIK* 8 (1939): 46–70, here 48, also mentions the connection of the Nile flooding with the star Sothis. Broekhuis, *De godin Renenwetet*, 125 and n. 1, mentions a phrase on an Oxyrhynchus papyrus which calls her 'Isis-Sothis'. J. Bergman, 'I Overcome Fate, Fate Harkens to Me', in *Fatalistic Beliefs in Religion, Folklore, and Literature*, ed. Helmer Ringgren (Stockholm: Almqvist & Wiksell, 1967), 35–51, here 38.

52 Ray, *Archive of Hor*, 21, 25, 157 (Appendix 1, 14).

53 Bergman, 'I Overcome Fate', 39, 43.

54 Bergman, *ibid.*, 38–41, has covered this topic well. Time and length of life will be explored below, 2.4 and 2.5.

but portions of the hymn concerning Isis's rulership of fate (here called τὸ εἰμαρμένον) are.⁵⁵ The relevant lines are:

- 4 I set down laws for men, and what I have enacted no one is able to change
 16 I made the just strong
 28 I made the just stronger than gold and silver
 29 I ordained the true to be esteemed beautiful
 35 I imposed retribution on those acting unjustly
 38 With me the just prevails
 46 Whatever I determine, this too is accomplished
 47 For me everything gives way⁵⁶
 48 I free those in bonds
 52 I am she who is called lawgiver.
 55 I conquer fate
 56 Fate obeys me
 57 Hail Egypt, who nourished me⁵⁷

Bergman has thoroughly dealt with Isis's connection to Egyptian fate, and we explore Egyptian ideas of fate in relation to the Agathos Daimon and to astrology below (2.4–2.5). I shall just make two points. First, Isis sets laws, ordains and decrees fate (in line with the Egyptian concept of fate), rather than allotting it (this is more Greek). Second, Isis is not only in charge of 'fate' in Greek texts (including this and other similar ones), she also appears in Egyptian inscriptions as a 'mistress of Shai ('fate'), who brings Renenet into being', *nb(.t) ššy<.t> šhpr rnn(.t)*, and 'mistress of life, ruler of Shai (fate) [and] Renenet (fortune)', *nb(.t) ḥnh ḥmw.t ššy rnn(.t)*.⁵⁸ The evidence suggests that the Egyptian

55 Bergman, *ibid.*, 41, suggests this neuter form of εἰμαρμένῃ may represent the Egyptian masculine *ššw*.

56 I am using Bergman's translation of ἐπέχει here, 42 and n. 1 (following Müller, *Isis-Aretalogien*, 71–72); this augmented form of εἶκω would correspond to the Egyptian *hmy*, retire, retreat. Other translators (e.g. Burstein, *Hellenistic age*, 147) have completely missed this. In his hypothetical version Quack, 'Ich bin Isis', 339, 358 has not followed Bergman or Müller, preferring ἕλς, 'rise' (sich erheben) (*CDD* 5, 115, 'to stand, arise').

57 See Appendix 3.A for the Greek.

58 BM 70 and BM 1162 (26th dynasty, 6th c. BCE) respectively, in Quaegebeur, *Shai*, 86 and Bergman, 'I Overcome Fate', 37 (both cite Müller, *Isis-Aretalogien*, 84 and n. 8); also, for BM 1162, see O. Perdu, 'Un appel à Isis (statue Londres, BM [1162])', *Cd'É* 74, no. 148 (1999): 231–39 (text 233, 3; translation 234), cited in Quack, 'Ich bin Isis', 361, n. 196. For other similar examples, see Bergman, 37–38; Quaegebeur, 85–87.

conception of Isis has transferred into Greek writings about her,⁵⁹ producing descriptions which are actually rather un-Greek.⁶⁰ Isis holds power over fate, possesses the power of providence,⁶¹ is able to loose the bonds of those fettered by *heimarmenē*. Isis lays down laws and enforces justice, an all-powerful goddess similar, in fact, to the 'primary god' who directs primary providence in Ps.-Plutarch's essay 'On Fate'.⁶² Only such a powerful deity could be victorious over *heimarmenē*, could compel its obeisance. Furthermore, Isis and Agathe Tyche are one in the Isis aretalogies. We see in these hymns, written in Greek but expressing an Egyptian viewpoint, an exemplar of Egyptian ideas of fate prevailing over Greek ideas.⁶³ This is not unforeseeable (blind) fortune, the random chance of the Greek and Roman conception; this is the aware and all-seeing Fortune (*fortuna videns* or even *providens*) of a powerful goddess who controls destiny, but who can be propitiated.⁶⁴ The following excursus

-
- 59 See n. 44. More content analysis of specific passages and their Egyptian origins in Bergman, 'I Overcome Fate' and *Ich bin Isis*; Plutarch, *Plutarch's de Iside et Osiride*, ed., trans. and comm. J. Gwyn Griffiths, (Cardiff: University of Wales Press, 1970); Müller, *Isis-Aretalogien*; and Dousa, 'Imagining Isis', 149–84.
- 60 The Egyptian goddess Isis is a 'mistress of fate', but the gods are subject to fate in classical Greek religion; see e.g., Aeschylus, *Prometheus Bound*, trans. Herbert Weir Smyth (Cambridge, MA: Harvard University Press, 1926), lines 515–518 (see Chapter 10, 1.3, 345). See also Dodds, *Greeks and the Irrational*, 34; Greene, *Moirā*, 124–25. Bergman, 'I Overcome Fate', 37–42; Müller, *Isis-Aretalogien*, 74–85; Quaegebeur, *Shai*, 28; and Quack, 'Ich bin Isis', 336–39, 361–62 discuss Egyptian antecedents matching statements in the aretalogy. However, I disagree with Quack's (339, commentary 362) changing of *ἴσχυς* to *σῆνυς* (following P. Insinger) in line 56 ('translating' *εἰμαρμένον*), since the same word is used in line 55; see my n. 118 below.
- 61 Bergman, 'I Overcome Fate', 44 and n. 1 mentions P. Oxy. 1380 (another Isis aretalogy) which actually calls Isis '*pronoia*' (see Totti, *Ausgewählte Texte*, 65, lines 43–44, 85); in this hymn, though, it is only (strongly) implied. See also Apuleius, *Metamorphoses*, xi, 12 (Helm, 275.20–21), referring to Isis: '... by the providence of the greatest goddess...' '... deae maximae providentia...'
- 62 There is also a correlation between *heimarmenē* and law outlined in *De fato* 568d. See below, 2.4, 103 and Chapter 1, 2.1, 29; 3.3, 37, n. 75; 3.4, 40, n. 86.
- 63 The Egyptian outlook is discussed by Fowden, *The Egyptian Hermes*, 46–47, whether or not the poem is a translation from Egyptian. See also the discussion of Isis's Egyptian centrality within her widening Mediterranean influence in Sfameni Gasparro, 'Hellenistic Face of Isis', 54–62.
- 64 See Bergman, 'I Overcome Fate', 44–45; he mentions the important ending to Apuleius's *Metamorphoses*, with an Isis very much like the one portrayed here. The functions and powers of these two kinds of fortune are so different that it is almost as if the two, blind and seeing, are connected in name only. The first is connected to chance, the second to providence. (See also below, n. 143.)

demonstrates Tyche's powerful role in sites beyond Egypt, with some interesting astrological and (possibly) Egyptian connections.

1.4 *Excursus: Tyche and the Zodiac at Khirbet et-Tannur*

The Nabataean religious site of Khirbet et-Tannur (near Petra, Jordan) was excavated by Nelson Glueck in 1937.⁶⁵ It has recently received thorough treatment by Judith McKenzie and a team of scholars using Glueck's archives.⁶⁶ Probably the most famous artefact from this site is a sculpted zodiac now in the Cincinnati Art Museum (CAM 233). In the center of this zodiac is a bust of Tyche; the entire zodiac ring and Tyche is supported by a winged Nike. Other astrological iconography includes seven planetary busts on the Inner Temenos Enclosure Frieze⁶⁷ and twelve zodiac busts on two pilasters of Altar Platform 3.⁶⁸ Though this is not the place to make a thorough analysis of the astrological material,⁶⁹ the intersection of Tyche and astrology at this site is worth examining.

The zodiac is unusual. Although it appears in a typical ring, the signs are divided: at the top of the circle, Aries on the top left runs counter-clockwise down the left side to Virgo, while Libra on the top right runs clockwise down the right side to Pisces (Virgo and Pisces missing in the photograph). Iconographically, zodiacs may run either clockwise or counter-clockwise, but very few zodiacs run in two directions.⁷⁰ No other extant zodiac puts Aries and Libra at the top of the circle with their consecutive signs running in opposite directions.

A compelling feature is the Tyche in the centre of the zodiac. She is identified as such by her mural crown and veil; behind her on the left is a crescent moon and on the right two sticks joined together, one ending in a crescent-like shape and the other topped with an ear of wheat or possibly a pine cone.⁷¹

65 N. Glueck, 'The Nabataean Temple of Khirbet et-Tannûr', *BASOR* 67 (1937): 6–16.

66 J. S. McKenzie et al., *The Nabataean Temple at Khirbet et-Tannur, Jordan: Final Report on Nelson Glueck's 1937 Excavation*, 2 vols. (Boston: American Schools of Oriental Research, 2013). See the list of Glueck's published works on the site, I, 308. I thank Joseph Greene for alerting me to this publication and his kindness in giving me access to it.

67 *Ibid.*, I, 176 (fig. 331), 219, 221.

68 *Ibid.*, I, 220 (fig. 380), 221.

69 See the bibliography of previous work on the zodiac in *ibid.*, I, 213.

70 The coffin of Heter (125 CE) is one (*EAT* III, 93–95, Pl. 50 [no. 71]). For the directions of zodiacs, see the images in H. G. Gundel, *Tierkreisbilder im Altertum. Kosmische Bezüge und Jenseitsvorstellungen im antiken Alltagsleben* (Mainz am Rhein: Verlag Philipp von Zabern, 1992). See also Chapter 5, 2.2, 178 and n. 87 for more on zodiac arrangements,

71 McKenzie et al., *The Nabataean Temple at Khirbet et-Tannur*, I, 206.



FIGURE 3.4 *The Tyche Zodiac from Khirbet et-Tannur.*⁷²

Scholars agree that she represents Tyche. Although this sculpture is probably the most striking rendition of Tyche, she appears in other sculptures at the site,⁷³ where she is paired with a male god with a scepter, a thunderbolt or both.⁷⁴ There are, in addition, large cult statues of the main god and goddess worshipped at the site. According to McKenzie et al.'s reconstruction, these were placed in a niche on the Altar Platform, possibly with the Tyche Zodiac suspended between them on the back wall.⁷⁵ Since the temple faced almost due east (it is within 1°30'), at the equinoxes the rays of the sun would have struck 'the niche exactly between the cult statues.'⁷⁶

72 Ibid., I, 83 (fig. 91). Photograph with permission of the Cincinnati Art Museum, Ohio, USA Museum Purchase/Bridgeman Images.

73 Ibid., I, 206, 209 (figs 361, 363).

74 Ibid., I, 206, 209 (figs 360, 362).

75 Ibid., I, 72 (fig. 75), 75, 176 (fig. 331), 193–201.

76 Ibid., I, 217. It seems plausible that the unusual arrangement of the zodiac was to emphasise the equinox. Though probably unintentional, in its vertical orientation this arrangement also depicts the astrological concept of antiscia (signs of equal light; see Appendix 1.A, 1.5 and Fig. 1.3, 'Familiarities', 405). In this scheme, the sign vertically opposite Aries is Virgo, and Libra is vertically opposite Pisces; the other signs are also vertically linked to their antiscia (Taurus-Leo, Gemini-Cancer on the left and Scorpio-Aquarius, Sagittarius-Capricorn on the right).

The female cult goddess likely incorporates aspects of the two smaller Tyches.⁷⁷ Her local association is, probably, to the goddess Allāt.⁷⁸ Interestingly, however, there also appears to be an Egyptian connection, to Alexandria and depictions of Isis; the male cult god also shows associations with Sarapis (for instance, he wears a *kalathos*).⁷⁹ There is other evidence of the iconographical influence of Isis and Sarapis at sites around Khirbet et-Tannur.⁸⁰ Tyche, as well, is present at other sites outside of Egypt, including Palmyra and Dura-Europos. This evidence suggests that the cult god and goddess at Khirbet et-Tannur took on aspects of foreign gods, especially Sarapis, Isis and Tyche, coupled with local gods. Given Sarapis's associations with the Agathos Daimon in Egypt, it is possible that the cult god at Khirbet et-Tannur implicitly incorporated the Agathos Daimon aspect as well, given the cult goddess's associations to Tyche.

Other Near Eastern sites provide further evidence of Tyche and Genius cults. Three adjacent altars on the Palmyrene Gate at Dura-Europos (in northern Syria) contain inscriptions in Palmyrene Aramaic to Gad (*gd*), equivalent to Tyche,⁸¹ in Greek to the Tyche of Dura (Τύχη Δούρας) and in Latin to the Genius of Dura ('genio Dura').⁸² Lucinda Dirven has concluded: 'From this it may be inferred that Tyche, Gad and Genius were identical notions to the Roman troops stationed at Dura.'⁸³ However, as far as Tyche and Genius are concerned, on religious grounds there is no reason why a Tyche *and* a Genius of a place cannot both be propitiated. On military-historical grounds the Latin inscription, made by Roman soldiers, is similar to military inscriptions to local

77 Ibid., I, 206, 209.

78 Ibid., I, 197–98.

79 Ibid., I, 196, 204, 225; and see above, I.1, 78.

80 Ibid., I, 203–04.

81 See Chapter 4, 1.4, discussion of Gad, 129–30.

82 See S. Downey, 'Temples à escaliers: The Dura Evidence', *California Studies in Classical Antiquity* 9 (1976): 21–39, here 29 and nn. 32 and 33. L. Dirven, *The Palmyrenes of Dura-Europos: A Study of Religious Interaction in Roman Syria* (Leiden/Boston/Cologne: Brill, 1999), 124, gives the Greek (with a reference to n. 95, which gives sources of the texts), also see 326 n. 493; and K. Dijkstra, *Life and Loyalty: A Study in the Socio-Religious Culture of Syria and Mesopotamia in the Graeco-Roman Period Based on Epigraphical Evidence* (Leiden: E. J. Brill, 1995), 280, gives a transcription and translation of the Latin text. Coincidentally, three astrological charts (one repeated seven times on a wall in the 'House of the Archives') have also been found in private houses at Dura-Europos: nos. 176, 219 I (repeated 7 times) and 250,1, in Neugebauer and Van Hoesen, *GH*, 49, 54, 58, 162. All examples were crudely drawn circles bisected by vertical and horizontal lines.

83 Dirven, *Palmyrenes of Dura-Europos*, 124.

genii at other sites, so why could not the same deity, distinct from Tyche, also be propitiated here?⁸⁴

Such evidence helps strengthen the proposal of an unacknowledged pairing of Tyche and Daimon at Khirbet et-Tannur. We do not know under what names the god and goddess were worshipped here,⁸⁵ but their links to Sarapis and Isis (who in Egypt have explicit links to Agathos Daimon and Agathe Tyche) seem clear, and the link to Tyche is undeniable. The astrological components of the site combine with the powers of god and goddess to address the particular concerns of human fortune, fate and worship on both an earthly and heavenly level.

We now return to Egypt to consider the importance of the Egyptian deity Shai to the Agathos Daimon and conceptions of fate.

2 Shai, the Agathos Daimon and Fate

We have already seen correlations between the Egyptian god Shai and the Greek Agathos Daimon. Now we explore Shai's attributes in more detail, as well as those of goddesses linked to him, namely Renenet, Meskhenet and Shepset. Since Shai is associated with fate or destiny, by investigating his attributes, including the origins and meaning of his name, we may then compare Egyptian ideas with notions of fate in two other cultures, Greek and Mesopotamian. These may have implications for notions of astrological fate.

2.1 *Shai as an Egyptian Deity*

Shai is a shape-shifting deity with no consistent guise. He personifies what we, conveniently, call 'fate' (but meaning, in a most elementary sense in Egyptian, 'what is decreed'). Sometimes he carries out the will of other gods concerning that fate, but other times dispenses it on his own. He is a protective local deity

84 On cultic practices by the Roman Military at their places of deployment, see O. Stoll, 'The Religions of the Armies', in *A Companion to the Roman Army*, ed. Paul Erdkamp (Oxford/Malden, MA: Blackwell Publishing Ltd., 2007), 467: 'Even the sacred areas... are part of this cultic activity at the place of deployment... dedicating an altar... most importantly and frequently to the *Genius huius loci*, the tutelary spirit of the previous place, was customary and possibly obligatory when leaving one place...'. This is exactly the situation for the Dura-Europos inscription to the *genius Dura*, which was dedicated by veterans ('emeriti').

85 McKenzie et al., *The Nabataean Temple at Khirbet et-Tannur*, I, 226.

but also a personal protector. In other words, he is difficult to pin down.⁸⁶ The main elements of his attributes follow.

Shai as a god personifying fate is first attested in Egyptian writings in the New Kingdom. In some inscriptions (e.g., the funerary chapel of Ramses I at Abydos), he appears as a god (along with the goddess Renenet) who carries out a divine commandment, but does not necessarily decree himself: 'Shai is before them as well as Renenet: they act in accordance with what has been commanded'.⁸⁷

In other instances, however, Shai is clearly responsible for a fate given at the moment of birth, which is revisited at the moment of death. A well-known portrayal of Shai is in the Papyrus of Ani, a famous rendition of the *Book of the Dead* (better translated as the *Book of Going Forth by Day*). In this text, one of the most important scenes is the weighing of the heart, and here Shai, along with Meskhenet (goddess of childbirth) and Renenet (goddess of nurturing), stands by as the heart of Ani is judged against the maat-feather of truth and rightness (Figure 3.4).

Shai is represented in human form with a bull's tail.⁸⁸ As proof of his divine status, his name is written with the god-determinative. Meskhenet's name sports the bed determinative, symbolising her function as a divine midwife; and Renenet has both the determinative of a woman nursing, and the snake determinative that becomes synonymous in later periods with both Shai and Renenet. Ani's *Ba*, his soul (pictured in the form of a bird with Ani's head), also watches the proceedings.

Here the moment of birth and the destinies decreed thereby are connected with the moment of death and the ultimate fate of the deceased. The presence of these 'fate' divinities, along with Ani's *Ba*, suggests further that 'what has been decreed' at the beginning of life can change to some extent through the actual living of that life, and how the person deals with what they have been given.⁸⁹ If all has been ordained and settled in advance, why would the deities

86 In this he is not unlike the Greek conception of the daimon, with its various conceptions.

87 *ššy m-b3h-sn mitt rnn.t ir-sn hft wdd.t*. Quoted in Quaegebeur, *Shai*, 146 (n. 7 for references to the quotation).

88 Quaegebeur, *Shai*, 148, says the bull's tail is a sign of his divinity, but J. G. Griffiths, 'Review: *Le Dieu Égyptien Shai dans la religion et l'onomastique* by Jan Quaegebeur', *JEA* 64 (1978): 178–79, here 179, disagrees that this is a divine symbol.

89 Miosi, 'God, Fate and Free Will', esp. 94–97, 101–02, advances the theory that there is an Egyptian divine law of retribution and reward, based on how one acts. C. Eyre, 'Fate, Crocodiles and the Judgement of the Dead: Some Mythological Allusions in Egyptian Literature', *SAK* 4 (1976): 103–14, here 108–10, also discusses the fate components in this vignette.

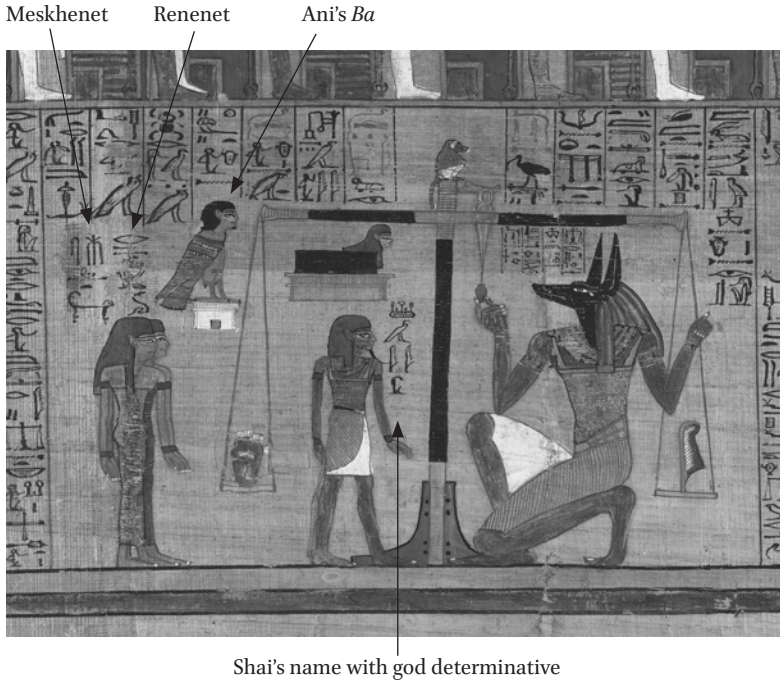

FIGURE 3.5 *The weighing of the heart in the Book of the Dead, from the Papyrus of Ani.*⁹⁰
(PHOTOGRAPH BY PERMISSION OF THE BRITISH MUSEUM, © TRUSTEES OF THE BRITISH MUSEUM).

and *ba* need to be present, unless the ultimate fate could be different? Indeed, why have a weighing of the heart at all?

There is some question as to whether divinities like Shai and Renenet were of the same stature as gods, or whether they should be considered as something less. In Egyptian culture, all divinities are called 'gods' (*ntrw*),⁹¹ but

90 See also R. O. Faulkner and O. Golet, Jr., *The Egyptian Book of the Dead: The Book of Going Forth by Day* (San Francisco: Chronicle Books, 1994), 155 (commentary on Plate 3).

91 D. Meeks, 'Demons', in *The Ancient Gods Speak*, ed. Donald B. Redford (Oxford/New York: Oxford University Press, 2002), 102. The concept of *ntr* has been historically difficult to categorise. It contains the sense of divine, and is often translated as 'god', but its semantic field is different from that of other cultures (such as the Greek *theos*). See Dunand and Zivie-Coche, *Gods and Men*, 7–13. O. E. Kaper, *The Egyptian God Tutu: A Study of the Sphinx-God and Master of Demons with a Corpus of Monuments* (Leuven: Peeters, 2003), 122, remarks: 'Egyptian gods are notoriously hard to classify, as there is a fluidity to their nature which allows them to manifest themselves on different levels at the same time.' See also E. Hornung, *Conceptions of God in Ancient Egypt: The One and the Many*, trans. John Baines (Ithaca: Cornell University Press, 1982), 33–65. D. Meeks, 'Notion de « dieu » et structure du panthéon dans l'Égypte ancienne', *RHR* 205, no. 4 (1988): 425–46, here

Dimitri Meeks refers to Shai, Renenet and Meskhenet as ‘demons’.⁹² Since Shai sometimes carries out the will of other gods, he and his companions could be characterised as ‘lesser’ gods.⁹³ In some instances Quaegebeur calls Shai a ‘génie’,⁹⁴ and even describes a Thirtieth Dynasty inscription on a sarcophagus as representing Shai as a ‘démon serpent terrifiant’.⁹⁵ This inscription is a rare example where Shai is not portrayed as good;⁹⁶ for the most part Shai and his companions (usually Renenet, Meskhenet or Shepset) have a distinct ‘guardian angel’ function, protecting the life they have helped bring into being. In this role they are not unlike Hesiod’s guardian daimons, or even Plato’s daimon chosen by the souls in the Myth of Er⁹⁷ (I do not imply that they had all the Hesiodic or Platonic functions). But the distinction between god and daimon is not an Egyptian one.

The connection of Shai and his companions with birth is critical, because the appearance of deities who give one’s fate at the moment of birth show the importance that having a destiny played in Egyptian thought,⁹⁸ especially in the New Kingdom and after.⁹⁹ Meskhenet oversees the labour, and supplies ‘the personal stock of capabilities given to each person at his birth’, which was not to be tampered with by the person during his lifetime.¹⁰⁰

430–46, theorises that an entity becomes a *ntr* through ritual as a means of divinisation. See also the summary of M.-A. Bohême, ‘Divinity’, in *The Ancient Gods Speak*, ed. Donald B. Redford (Oxford/New York: Oxford University Press, 2002), 106–12.

- 92 Meeks, ‘Demons’, 103–04. Meeks admits this is a contrivance of modern scholarship, not indigenously Egyptian (102). In his ‘Notion de dieu’, 429, he says that *ntrw* are not only what we would call ‘gods’, but also spirits, abstract concepts, kings, animals and even the ordinary dead.
- 93 Kaper, *The Egyptian God Tutu*, 122, n. 58, citing K. A. Kitchen, *Ramesseid Inscriptions*, v1, 22.6, points out that Egyptians did acknowledge a hierarchy of divine beings—both great (*wrw*) and small (*ndsw*) gods (this inscription is from Ramesses IV’s Stela to the Gods from Abydos).
- 94 Quaegebeur, *Shai*, e.g., 149, 151–53.
- 95 *Ibid.*, 150.
- 96 A parallel to this text refers to the ‘serpent Neshai’ (*ibid.*, 150–51) and not to Shai.
- 97 Hesiod, *Works and Days*, 121–23, 252–55; Plato, *Republic*, 617d–e, 620d–e.
- 98 I do not mean to imply that Shai and the others discussed here are the only divinities associated with fate: Hathor (e.g., the ‘Seven Hathors’) and other gods also play a role. But especially in later texts, and in the Greco-Roman period, Shai and his companions do seem to be particularly important ‘fate’ deities. (And Shai specifically links with the Agathos Daimon, which connects to Hellenistic astrology.)
- 99 The Amarna period seems to be a critical turning point.
- 100 Meeks, ‘Demons’, 104. See the discussion of Meskhenet and her attributes, including connections to Shai (although the main focus of the work is the goddess Tjenenet), in

Other birth deities connected with destiny are the Seven Hathors who, like the evil fairy in *Sleeping Beauty*, decree the (bad) events to occur in the person's life,¹⁰¹ especially the way one will die.¹⁰² The Seven Hathors provide the plot outline in the 'Tale of the Doomed Prince', when they decree that he will die by the crocodile, the snake or the dog (the Prince sets out to overcome these decrees, and [probably] succeeds—an example of the Egyptian ability to negotiate one's fate).¹⁰³ Gertrud Thausing points out that, in spite of the Prince thinking his fate is set, his wife, who kills the snake meant for him, reminds him that 'Your god has put one of your fates [šꜣy.w] in your hand. He will also give you the other ones!'¹⁰⁴ Like the weighing of the heart, the implication is that these are not set immutably at birth, but may change during the course of a life depending on a person's actions. Thausing links the Seven Hathors with the Pleiades.¹⁰⁵ She also posits a starry connection between fate and the seven stars of the Great Bear which carry the scale which balances the world.¹⁰⁶

M. T. Derchain-Urtel, *Synkretismus in ägyptischer Ikonographie: Die Göttin Tjenenet* (Wiesbaden: Otto Harrassowitz, 1979), 23–36, esp. for Shai, 26, 28 and 31; also, for Meskenet, A. von Lieven, *Grundriss des Laufes der Sterne. Das sogenannte Nutbuch*, vol. 1. *Text* (Copenhagen: Museum Tusulanum Press, 2007), 133–34.

101 Meeks, 'Demons', 104.

102 J. K. Hoffmeier, 'Fate', in *The Ancient Gods Speak*, ed. Donald B. Redford (Oxford/New York: Oxford University Press, 2002), 121.

103 Discussed more below, in comparison with both Greek and Mesopotamian ideas.

104 Thausing, 'Der ägyptische Schicksalsbegriff', 67 (her translation: '... dein Gott (= Schicksal) hat eines von deinen Geschicken in deine Hand gelegt. Er wird auch die andern dir geben!'). W. K. Simpson, ed. and trans., R. O. Faulkner, trans., and E. F. Wente, Jr., trans., *The Literature of Ancient Egypt: An Anthology of Stories, Instructions and Poetry* (New Haven/London: Yale University Press, 1972), 90, say (Wente trans.): 'See, your god has delivered one of your fates into your hand. He will guard [you henceforth.]; Lichtheim, *Ancient Egyptian Literature*, Vol. 11, 202 says 'Look, your god has given one of your fates into your hand. He will protect [you from the others also]'. This passage also discussed in Eyre, 'Fate, Crocodiles', 105. The text is P. Harris 500 verso, 8.5 (hieratic original, now in the British Museum; hieroglyphic text in Gardiner, *Late-Egyptian Stories*, 8 (the second sentence is lacunose).

105 Thausing, 'Der ägyptische Schicksalsbegriff', 67.

106 Thausing, *ibid.*, 46–49, 55, argues for the overarching presence of astral components and influence in the Egyptian concept of fate, which she connects with the New Year's night ceremony in which the gods balance the world for the coming year; the heliacal rising of Sirius was the beginning of the year. It occurred not at actual sunrise, but in the twilight before dawn 'when Sirius rose in the 11th hour of the night' (61, quoting H. Brugsch, *Astronomische und astrologische Inschriften der altaegyptischer Denkmäler*, in *Thesaurus inscriptionum aegyptiacarum*, Pt. 1 (Leipzig: J. C. Hinrichs'sche Buchhandlung, 1883), 91 [Brugsch quotes an inscription in the Tomb of Ramses VI]). This 'astronomischen

2.2 *Renenet/Renenwetet*

Renenet, as we have seen, is an important companion of Shai from the New Kingdom through the Greco-Roman period. They appear together many times both pictorially and literarily, and are perceived as complements of each other. *Rnn* means 'to nurse', and Renenet's function in the beginning was as a goddess who nurtured children. Her name can be used interchangeably with that of the goddess Renenwetet, as Quaegebeur has shown.¹⁰⁷ As Renenwetet she is in the Pyramid Texts, as a snake protecting the king. Renenwetet is a harvest goddess, associated with abundance and with the nourishment that is also Renenet's function.

Shai's assimilation with snakes comes about through Renenet.¹⁰⁸ Especially in the Ptolemaic and Roman Periods (before in some instances as well), Renenet is pictured in iconography either entirely or partially as a snake.¹⁰⁹ The writing of her name can contain the snake, as well as the determinative of the nursing woman.¹¹⁰ In the Greco-Roman period, her name is Thermouthis, the companion of Agathos Daimon, with many of the same functions: as a

Bestimmung' which begins every year gives a template and a correlation to the 'menschliche Bestimmung' which begins at birth (and is first applied to the king) (62; see also 55). This may, in fact, supply some understanding for the importance of the first place in astrology, which in modern depiction is shown as below the horizon, but in fact falls in that twilight period so important for 'determination'. In the Demotic story 'Setne Khaemwas II', the eastern horizon, where the sun first rises, is even called 'the beautiful horizon of Shai' (3, 27–28, *t3 3hwt nfr:t n p3-šy* [cited in Quaegebeur, *Shai*, 168]), another indication of its importance in determining human fate. Thus at the moment of birth, the sign on the horizon determines the rest of the chart which symbolises human destiny astrologically.

107 Quaegebeur, *Shai*, 153: 'Renenet et Renenoutet sont donc identiques quant à leur nom.'

108 Ibid.

109 E.g., see J. Leibovitch, 'Gods of Agriculture and Welfare in Ancient Egypt', *JNES* 12, no. 2 (1953): 73–113, esp. figs 2 (of unknown date and provenance) and 3 (images, 82, descriptions, 75) showing a nursing goddess with a snake body and a nursing snake with a human body; see also fig. 4 (p. 83), coins with facing snakes wearing crowns (these are syncretic Agathos Daimon/Shai and Isis/Hermouthis/Renenet). Fig. 2 also in Broekhuis, *De godin Renenwetet*, 52, pl. 11, no. 88; see also 25–26, pl. 7, no. 34, a relief of Renenwetet as snake with Hathor crown from Medīnet Mādi.

110 E.g., see R. O. Faulkner, *A Concise Dictionary of Middle Egyptian* (Oxford: Griffith Institute, Oxford University Press, 1962), 151, s.v. *Rnnt* and *Rnmwt*. In *Wb*, II, 436, the goddess Renenet is shown with the nursing-woman determinative (B5 in Gardiner's Sign-list), but starting in the Nineteenth Dynasty, with a snake determinative (*Wb*, II, 437). Dunand and Zivie-Coche, *Gods and Men*, 9, say the egg and the cobra were used as determinatives for goddesses, and they suggest that the cobra determinative became a word for goddess: 'The other was the cobra, which ended by actually serving to write the word goddess; we

protector, both personal and of a local space; she also brings good fortune (Bona Fortuna).¹¹¹ As seen above, Thermouthis assimilates to Isis¹¹² (and Agathos Daimon assimilates to Sarapis).

2.3 *Shepset*

Good fortune, or the capacity for it, was also the province of Shepset (which means ‘noblewoman’). The root of this word also means ‘rich’ or ‘wealthy’, which accounts for Shepset controlling good fortune. It can also mean ‘well-esteemed’, suggesting a good reputation. Shepset, like Shai and Renenet, is also a personal divine protector.¹¹³ Multiple Shepset-deities, and even related goddesses like Reret, are connected with a particular month,¹¹⁴ and therefore a ‘particular Shepset’ is assigned to a person at birth as her guardian.¹¹⁵ In the later version of her name, Tsepsis, she is often mentioned with the later version of Shai, Psais.¹¹⁶

We have seen Isis linked to both Renenet and Shepset. Renenet becomes Agathe Tyche in her Greek guise, and is accordingly pictured with Shai as Agathos Daimon. In this function she is not the goddess of a good ‘chance’ or

are left to think that the uraeus form in which many goddesses were incarnate was an essential vehicle for apprehending the divine in its feminine aspect.’

111 Quaegebeur, *Shai*, 153. For further discussion of Agathe Tyche and Renenet, see Barrett, *Egyptianizing Figurines*, 235–39.

112 Broekhuis, *De godin Renenwetet*, ch. 5.6, 105–09, describes this assimilation and shows its antecedents in earlier texts (though the two goddesses do not actually merge before the Greco-Roman era).

113 Quaegebeur, *Shai*, 155: ‘génie personnel’; 157, ‘le génie personnel protecteur Shepset, comparable à la fée-marraine ou à l’ange gardien...’.

114 For more on multiple Shepsets and their attributes, see Quaegebeur, *Shai*, 155–60 and K. Jansen-Winkel, ‘Eine Grabübernahme in der 30. Dynastie’, *JEA* 83 (1997): 169–78, esp. 176–78. For Reret, see D. Mendel, *Die Monatsgöttinnen in Tempeln und im privaten Kult* (Turnhout: Brepols, 2005). I thank the anonymous reader for the Jansen-Winkel and Mendel references.

115 Meeks, ‘Demons’, 104. This may be a source for Herodotus, *Histories*, II, 82.1: (Rosén, I, 187.13–15): Καὶ τὰδε ἄλλα Αἰγυπτίοισι ἐστὶ ἐξευρημένα· μείζ τε καὶ ἡμέρη ἐκάστη θεῶν ὅτευ ἐστί, καὶ τῇ ἕκαστος ἡμέρη γενόμενος ὅτέοισι ἐγκυρήσει καὶ ὅπως τελευτήσει καὶ ὀκοῖός τις ἔσται... ‘The Egyptians, too, found out to which god every month and day belongs, and to tell by the day of a man’s birth what fortune he will have, when he will die and what manner of man he is.’ (Herodotus, *The Histories of Herodotus of Halicarnassus*, trans. Harry Carter (London: Oxford University Press, 1962), 123).

116 Quaegebeur, *Shai*, 160.

'luck' which *may* happen, but of Fortune that *is* Good.¹¹⁷ In the transition to Hellenistic astrology, Shepset becomes Agathe Tyche as well, but Tyche in the sense of a good event (*shn nfr*) that may come to pass, and finds her place in the circle of the astrological places.¹¹⁸ While in most Hellenistic astrological texts the fifth place indicates material fortune through fertility and the production of children, Shepset's association as a goddess protecting the person from birth, and protecting the deceased in his journey to the after-life, may

117 This is the Good Fortune that Isis can dispense as the mistress of a Good Fortune that is all-seeing, not up to chance.

118 See Chapter 2, 2.2. This Egyptian phrase, *shn nfr*, is precisely equivalent to ἀγαθὴ τύχη on the Rosetta Stone (see *Urkunden II*, 188, 1 [Dem. 21, Gr. 36]; idem in Text 37.9, 205, 11 [Dem. 8]); cited in Miosi, 'God, Fate and Free Will', 110, n. 68; see also Quaegebeur, *Shai*, 141–42. This is literally a 'good event' or happening; it thus seizes the sense of *tuchē* as what 'happens to be', i.e. a chance occurrence. An interesting juxtaposition of *shn nfr* with *špšy* (and *ššy*) occurs in O. Hor 3, where the text (lines 3–4 *recto*) predicts a good fate and fortune ('favourable for your fate, favourable for your fortune': *nfr=s pšy=k ššy nš-nfr=s šy=k špšy.t*) for Ptolemy VI Philometor (ca. 180–145 BCE) in the coming year; eight lines later (12 *recto*), the text proclaims 'every good event' (*shny-nfr nb*) which Isis has caused for him: Ray, *Archive of Hor*, 21 (transcription), 25 (translation), Pls IV, 1va. (I thank M. Ross for transliteration; Dousa, 'Imagining Isis', 178 n. 118 has a typo, '*pšy=f*'). *Shn* is paired with *šy* in P. Insinger (as a recurring refrain): 'The fate (*pš-šy*) and fortune [event?'] (*pš-shny*) that come, it is the god who sends them.' (2, 20; 5, 11 et al.: see M. Lichtheim, *Ancient Egyptian Literature*, vol. III, 187, 189, etc.) Thus a good fortune as represented by Shepset connects to chance (good) events. The good fortune that the fifth represents can supply the possibility or capacity, but not certainty, of children, wealth and other concerns of the fifth. In P. Berlin 8345, I, 1; III, 11, *nš shny.w* has the sense of 'the things that happen to be' (Hughes translates as 'the chances, the fortunes', which he compares to τὰ ἀποτελέσματα, 'the outcomes'—Hughes translates this wrongly as 'influences'): G. R. Hughes, 'An Astrologer's Handbook', 58, commentary to I, 1; also idem, 'A Demotic Astrological Text', *JNES* 10, no. 4 (1951): 256–64, here 259 (note 1). (See the discussion in Winkler, 'Looking at the Future', 58–59. Note that others [e.g., A. von Lieven, 'Divination in Ägypten', 103] have followed Hughes in choosing 'influence' to translate *shn*, but 'outcome' is a better choice. J. F. Quack, 'Beiträgen zu den ägyptischen Dekanen und ihrer Rezeption in der griechisch-römischen Welt' (Habilitationsschrift, Freie Universität Berlin, 2003) [note: for this and additional citations from this text, I cite section numbers from a copy kindly sent to me by Quack in 2008 and, as needed, new section numbers from a 2014 version], e.g. §§1.2.3.17, 2.2.3 [2.3.3 2014], 2.2.5 [2.3.5 2014], translates as 'Vorzeichen', but there is no hint of 'fore-' or 'sign' in *shn*, but rather a (subsequent) event or outcome. *Shny*'s semantic field in common with τυγχάνω (see *Wb* III, 469–70) also supports the interpretation here of 'outcome'. Here may be yet another Egyptian connection for Manilius (see Chapter 2, 2.3) when he uses a word like *casus* in connection with the fifth place.

have some bearing on the meanings of the fifth. Note that this place is always associated to a feminine deity, whether in Greek, Roman or Egyptian iteration.

2.4 *Shai and Egyptian 'Fate'*

As we saw in Chapter Two, 2.2, the name of Shai in Demotic astrological texts is written with the snake and/or the god determinative, whether representing the eleventh place as a divine protector or ensuring a 'happy fate' for the holder of the chart.¹¹⁹ The meanings and development of the word that forms his name illuminate how fate was understood in Egypt. Shai derives from  š3[*l*] 'order' 'decree' 'determine'.¹²⁰ The first meaning in the *Wörterbuch* is 'bestimmen', but 'anordnen' also appears, and the word has the sense of a decree that brings something into being, often through a god or king.¹²¹ Raymond Faulkner says 'ordain, order; predestine; assign; settle, decide'.¹²² Fundamentally, then, š3 is ordaining or decreeing, with a sense of order, a *de facto* (or *de fato*?) regulation. These connotations are not that distant from the Latin *fatum* (derived from *for*, 'speak' or 'say', especially as a prophecy)¹²³ with the sense of fate as decrees or utterances which have the force of law. Š3i has this force of law as well: Quaegebeur tells us that 'š3i est également un terme technique désignant l'établissement des lois ...'.¹²⁴

Greek *heimarmenē*, literally 'that which has been apportioned', is not as obviously relatable (in that the idea of a spoken decree is not present in its etymology). But the idea of š3i having the force of law recalls the beginning of the Pseudo-Plutarch essay 'On Fate', where fate as actuality or activity (ἡ κατ' ἐνέργειαν εἰμαρμένη) is described as a 'law' (*nomos*) and a '*logos*', even, interpreting Plato's *Republic*, as a "divine law determining the linking of future events to events past and present" (568d).¹²⁵

Š3i appears first in the Old Kingdom (it is attested in the Sixth Dynasty *Maxims of Ptahhotep*), and becomes established in the Middle Kingdom.¹²⁶ Š3i

119 Respectively O. Neugebauer, 'Demotic Horoscopes', 120–21, Os. 5; Hughes, 'Astrologer's Handbook', 55, 57.

120 A. Gardiner, *Egyptian Grammar*, 3rd ed. (Oxford: Oxford University Press, 1927, repr. 1969), 594, 'appoint, command'.

121 *Wb*, IV, 402–03.

122 Faulkner, *Dictionary*, 260–61.

123 Lewis and Short, s.v. *fatum* and *for*. But we should not assume the connotation of an unchangeable *fatum*.

124 Quaegebeur, *Shai*, 45. See below for connections between š3i and speaking.

125 See Chapter 1, 2.1.

126 See e.g., the 'Story of Sinuhe' and the 'Teachings of Kagemni'; this last is written in Middle Egyptian, though its timeframe is the Old Kingdom.

is also 'ordain' in the 'Admonitions of an Egyptian Sage' (I, 7), dating from the First Intermediate Period (which precedes the beginning of the Middle Kingdom). The idea of a deity commanding by divine will (and the transfer of this power to a king) is also encompassed in *šš*; these commands can be actualised through speaking.¹²⁷ The idea of creation through speech is not foreign to Egyptian culture. In the Memphite Theology, a well-known creation myth of the Late Period, the world is created through names being spoken.¹²⁸ So a divine law with the sense of a decree made by the gods can be seen both in the (earlier) Egyptian and (later) Greek culture. Elke Blumenthal's correlation of *šš* with *dd* (speak or say) implies the decree as spoken, words which have the force of law, comparable to *heimarmenē* as a *logos*. Note that the tongue (representing *logos*) of Isis's son, Harpokrates, often pictured with his finger to his mouth, is described by Plutarch as *tuchē* and *daimōn*.¹²⁹

In the New Kingdom, nominal forms, the substantives *ššw* and *ššy*, come into use. These are no longer just 'commands' or 'decrees', but contain more explicit ideas of fate or destiny, a life divinely decreed. This concept develops especially in the Eighteenth Dynasty during the Amarna period. Shai becomes allied to the solar disk, in the expression 'the living Aten, lord of Shai' (*p³ itn ḥnh nb ššy*),¹³⁰ and 'determining life' (*šš i ḥnh*) which is almost equivalent in meaning to the common *di ḥnh* (giving life).¹³¹ With divine power transferred from god (i.e. the Aten) to him, Akhenaten is deemed a 'Shai, giving life' (*ššy didi ḥnh*), i.e., capable of decreeing life.¹³² Other gods are also lords of fate.¹³³ Life is decreed and ordered through *shai*; thus destiny is an antidote to uncertainty

127 Quaegebeur, *Shai*, 44: 'Elke Blumenthal fait remarque à juste titre que d'après les textes du ME le verbe *šš(i)* est synonyme de *wḏ* et *dd* et indique la destinée commandée par la divinité, et l'expression de la volonté du roi, d'autre part.' (citing E. Blumenthal, *Untersuchungen zum ägyptischen Königtum des Mittleren Reiches*, I. *Die Phraseologie* (Berlin: Akademie-Verlag, 1970), 91–94: B 5). As with Greek ἀκούω, the word for 'hear' in Egyptian also carries the meaning of 'obey' (*sdm* [n]) (e.g., 'I hear and obey'). Speech is implicit in command.

128 Morenz, *Egyptian Religion*, 164: 'It is "the mouth which pronounced the name of everything (*r mššt rn n iḥt nbt*)" from which Shu and Tefnut came forth, followed by the world of nature and ordered human history, embodied in the Ennead.'

129 Plutarch, *De Iside et Osiride*, 378c6 (Sieveking, 2.3): 'γλώσσα τύχη, γλώσσα δαίμων.' It is interesting that both τύχη and δαίμων are implicated with *logos* here. Griffiths, *Plutarch's de Iside et Osiride*, 536, relates this to the 'Opening of the Mouth' funerary ritual.

130 Quaegebeur, *Shai*, 40.

131 *Ibid.*, 45–46.

132 *Ibid.*, 40.

133 Miosi, 'God, Fate and Free Will', 71.

and chaos. The decrees of the gods bring human life under control and make it secure, ordered and contained.¹³⁴

With the ability to decree life, *šši* also becomes associated with the *length* of life. Both Morenz and Miosi, writing on the Egyptian concept of fate, emphasise repeatedly Shai's connection (or one of its forms) with length of life.¹³⁵ *Ššy* can determine life-span, but this could be negotiated with the gods. In other words, one's fate is not immutably fixed. In the 'Report of Wenamun' (2, 55–60) the prince of Byblos asks the god Amun for fifty more years of life than was fated for him.¹³⁶ The Hymn to Amun in P. Leiden I 350 (III 17–18) says that the god 'makes a lifetime long or shortens it'; 'he gives more than what is fated (*ššyt*) to him whom he loves.'¹³⁷ In the Akhenaten texts, we find *ššy* written with the sun determinative (☉, N5) further emphasising its signification as lifespan,¹³⁸ the sun is always associated with life because of its daily cycle of death and rebirth. The Demotic word, *šw*, has the same sun determinative and has been translated by Spiegelberg as 'Vorschrift, Bestimmung'.¹³⁹

If the power of life belongs to *šši*, so too the power of death. The Egyptian concept of *šši* also encompasses the idea of death as something ordained by the gods, and which is inescapable. Just as we say 'he met his fate', i.e. death, a *ššw nfr*, 'good fate', is a euphemism for death.¹⁴⁰ Analogous to the English

134 Thausing, 'Der ägyptische Schicksalsbegriff', 51–53, emphasises the importance of Ma'at, the Egyptian ordering principle (and goddess) of justice and rightness, to Old Kingdom Egyptian fate doctrine.

135 Morenz, *Egyptian Religion*, 71–72, 185; S. Morenz and D. Müller, *Untersuchungen zur Rolle des Schicksals in der ägyptischen Religion* (Berlin: Akademie-Verlag, 1960), 19, 23, 29; Miosi, 'God, Fate and Free Will', 71–72, 93, 95. Miosi, as well, 83, 87–88, makes the distinction between a fate which determines merely the length of life, and a fate which determines the 'manner' of life. Certain circumstances may be given by the gods, but how one behaves in one's life is not determined by them.

136 See Simpson, Faulkner and Wente, *Literature of Ancient Egypt*, 153; also Lichtheim, *Literature*, Vol. II, 228 (passage quoted by Hoffmeier in Redford, ed., *Ancient Gods, Ancient Gods*, 122).

137 Morenz, *Egyptian Religion*, 71 (following his translation); see also Quaegebeur, *Shai*, 78. For more on the gods' bestowing, lengthening or shortening human life, see Apuleius, *Apuleius of Madauros, The Isis-Book (Metamorphoses, Book XI)*, ed., trans. and comm. J. Gwyn Griffiths, (Leiden: E.J. Brill, 1975), 166–67.

138 Quaegebeur, *Shai*, 54. In the cosmology 'On the Primaeval Ocean', Shai is equated with the sun: M. Smith, *On the Primaeval Ocean* (Copenhagen: CNI Publications, 2002), 62–63.

139 Quaegebeur, *Shai*, 54 (see his n. 3 for Spiegelberg citation).

140 *Wb*, IV, 404: 'euphemistisch für Tod'; this phrase appears in the Harper's Song of Intef (M. Lichtheim, *Ancient Egyptian Literature: A Book of Readings*, vol. 1: *The Old and Middle Kingdom* (Berkeley/Los Angeles/London: University of California Press, 1973), 196 and

'Nothing is sure but death and taxes', the Egyptian would tell us 'His time does not fail to come; one does not escape what is fated' (i.e., there is no escape from death).¹⁴¹

In the Greco-Roman period other deities, such as Sarapis¹⁴² and Isis, also claim to control fate (see Section 1 above) and to be able to lengthen life. Apuleius shows us Isis's powers in *Metamorphoses*, XI, where she tells Lucius, 'But if by assiduous obedience, worshipful service, and steadfast celibacy you win the favour of my divine acquiescence [*numen*], you will know that I—and I alone—can even prolong [*prorogare*] your life beyond the limits established by your fate.'¹⁴³ Jewish astrology and tradition also connects length of life with fate.¹⁴⁴

Let us recap the connotations of *š3i* thus far. Its original meaning is that of commanding and decreeing, of ordaining, especially by gods and kings. These decrees have the force of law. By the New Kingdom, the idea of fate or destiny decreed at birth is established, and *š3i* is found in nominal forms with this meaning. 'Fate' decrees life, and is associated also with length of life, but this can be negotiated and changed, if the god is willing. In addition, 'fate'

n. 4; Simpson, Faulkner and Wente, *Literature of Ancient Egypt*, 306, translate 'destiny is good').

- 141 'The Instructions of Ptahhotep', 33, in Lichtheim, *Ancient Egyptian Literature*, Vol. 1, 72, quoted by Hoffmeier in Redford, ed., *Ancient Gods*, 121. The Egyptian word for 'taxes', coincidentally, also derives from *š3*: *š3yt*, dues, or fees which are imposed. See *Wb*, IV, 403, 'Abgabe, Steuer'; Gardiner, *Egyptian Grammar*, 594; Faulkner, *Dictionary*, 261.
- 142 'I change the garb of the *moirai*!' See Morenz, *Egyptian Religion*, 74 and n. 93. See Chapter 6, 1.3, 202, n. 36 (continues on 203).
- 143 Apuleius, *Metamorphoses*, XI, 6 (Helm, 271.5–8): 'Quodsi sedulis obsequiis et religiosis ministeriis et tenacibus castimoniis numen nostrum promerueris, scies ultra statuta fato tuo spatia vitam quoque tibi prorogare mihi tantum licere.' Trans. (modified) of J. A. Hanson, in Apuleius, *Metamorphoses*, ed. and trans. J. Arthur Hanson, 2 vols. (Cambridge, MA/London: Harvard University Press, 1989), II, 303, 305. Morenz, *Egyptian Religion*, 74 and n. 96, mentions this passage. Interestingly, the Latin used here for 'prolong life', *vitam prorogare*, becomes the Renaissance astrological term (*prorogator*) for the Greek *aphetēs*. See the interesting analysis of Griffiths, *The Isis-Book*, 241–42, where he argues that when Isis syncretises with Tyche, a Fortune is created which is no longer blind and nefarious, but benevolent and prescient (he bases his argument partly on the Egyptian syncretism of Isis-Thermuthis). The same British Museum statue, ca. 590 BCE, (see above, 1.3, n. 58) where Sheshonq proclaims Isis the ruler of Shai and Renenet, also asks the goddess to prolong his existence: Perdu, 'Un appel à Isis', 233, line 6; 234, translation.
- 144 See F. Schmidt, 'Horoscope, Predestination and Merit in Ancient Judaism', *Culture and Cosmos* 11, no. 1 and 2 (2007): 27–41; Morenz, *Egyptian Religion*, 74.

is a euphemism for death. These aspects of *šš'i* are also linked to astrology, both in theory and practice.¹⁴⁵

2.5 *Astrological Length of Life*

This relationship between lifespan and fate is significant for astrology, because determining length of life is an important astrological concern, and its practice nearly always employs, among other criteria, both the Lot of Fortune and the eleventh place, and in some cases the Lot of Daimon. (See Chapter Nine, Section 7.) One wonders if the reason these particular elements are involved in the doctrine comes from the Agathos Daimon and his connection to Shai, to this ancient Egyptian association of *šš'i* with lifespan. In addition, the sun-determinative as a life-signifier correlates to the astrological Sun's importance in determining length of life. (Note that astrological *sect*, determined from whether the Sun is above or below the horizon, is an important criterion in all systems which determine lifespan.)

For Paulus Alexandrinus (ch. 36), the planet chosen to be a 'house-master' (*oikodespotēs*), and thus gain power over the length of life, is discovered from planets ruling the Sun by day and the Moon by night. (In addition, the eleventh and fifth places are among those considered 'operative' (χρηματιζοντες) in finding this planet.)¹⁴⁶

Vettius Valens' system (III, 1) determines an *epikratētōr*, from both the Sun and the Moon in operative places; this becomes a 'releaser' (*aphetēs*, in Firmicus *dator vitae*, later *prorogator*)¹⁴⁷ from which the length of life can be determined. The usual candidates are the Sun, the Moon, the Lot of Fortune, the prenatal syzygy or the Ascendant (all these positions involve the luminaries and/or the horizon in some way, and all are important as a means of measuring time). The *aphetēs* is chosen based on its strength, which is measured by its sect alignment and its position in an operative place. If the first candidate is not in a suitable place, one considers the next best candidate, etc. Once the *aphetēs* is determined, its bound [a.k.a. term]-ruler becomes the 'giver of years'. A strong bound-ruler, well-placed, gives a larger amount of years, while a weak one gives a lesser amount. Valens (III, 11) ascribes another technique for determining length of life from the Lot of Fortune and its rulers (or, in some cases, the Lot of Daimon) to Nechepso (see discussion of this doctrine in Chapter Nine,

145 C. J. Bleeker, 'Die Idee des Schicksals in der alt-ägyptischen Religion', in *The Sacred Bridge* (Leiden: E.J. Brill, 1963), 115, comes to a similar conclusion regarding Egyptian fate and astrology.

146 See Chapter 7 for more on the *oikodespotēs*.

147 See definition in Appendix I.A, 3.1.

Section 7, ‘The Lots and Length of Life’). The attribution to Nechepso may underscore an Egyptian origin, at least for this practice.

In an example in Dorotheus III, 2 the ruler of the Ascendant is the *aphetēs*, and falls in the eleventh place, the place of the Good Daimon. Dorotheus says this is a ‘good place’¹⁴⁸ even though, because Mars is there, the outcome is bad (it would be even worse if the eleventh place were not involved).

Ptolemy’s system for determining length of life (see Chapter Two, 2.6), is also based on places suitable for finding an authority for deciding lifespan. He differs from other authors in utilising specific amounts of degrees in the places, not just their signs, because of his quest to find physical causation. The most ‘lordly’ or authoritative positions for releasing are those of the Sun, the Moon, the Hour-marker and the Lot of Fortune.

These examples illustrate the importance of the Sun and the use of both the eleventh and fifth places in these schemes, as well as the Lots of Fortune and Daimon. (Ptolemy employs only the daytime formula for the Lot of Fortune¹⁴⁹ in length of life calculation, but this will be the *de facto* Lot of Daimon in any nocturnal nativity.) Thus the Good Daimon appears in two guises in this technique: both by place and by lot.

3 Mesopotamian and Egyptian ‘Fate’

At this point it will be helpful to compare the Egyptian *š3i* with the Mesopotamian (Akkadian) *šāmu*, from which their ‘fate’ word, *šimtu*, derives.¹⁵⁰ This verb’s semantic field has some similarities with *š3i*, in that both have the sense of ‘decree’ or ‘determine’ (i.e., ‘fix’) as a primary meaning.¹⁵¹ *Šimtu* (the nominal form) also contains the idea of pre-ordaining or ordering, and is associated with the gods’ ability to ordain things both in the divine and human realms. This ordering, once established, becomes a cultural norm.¹⁵² (Note that

148 Dorotheus, III, 2.27 (Pingree, 243).

149 Ptolemy, *Tetr.*, III, 11.5. See Chapter 9, Section 6, 329–30 and n. 77. Other authors use both nocturnal and diurnal formulae for Fortune. For more on this issue, see Chapter 9, Section 7.

150 F. Rochberg-Halton, ‘Fate and Divination in Mesopotamia’, *AOF Beiheft* 19, no. 28 (1982): 363–71, here 363.

151 *Ibid.*, 363 and n. 5.

152 *Ibid.*, 364.

the Greek *nomos*, in addition to meaning ‘law’, has as its first meaning a ‘habitual practice’ or ‘custom’.)¹⁵³ Also like *š3l*, the decrees of *šimtu* have a legal force.¹⁵⁴

A kind of rank is associated with *šimtu*, i.e. those who give it always dispense something within their power to those who do not have it. These may be gods giving to humans, kings to their subjects, or private individuals to their heirs.¹⁵⁵ Rank is also implicit in *š3y*, but it is rare for an ordinary human to bestow what is normally a divine prerogative.¹⁵⁶ It is the gods and the king who are able to ‘determine’ events, the king being able to appropriate the divine attribution.¹⁵⁷ The god or king orders, in order that something (an event) comes to be.

Šimtu can also mean death, just as *š3w* in Egyptian. The Mesopotamian ‘he went to his fate’ and ‘fate took him away’¹⁵⁸ are very similar to the Egyptian ‘His fate brought on his death’.¹⁵⁹ Interestingly, *šimtu* is also the word for a last will and testament, which decrees the disposition of one’s estate at the end of life.¹⁶⁰

In addition *šimtu*, like *š3y*, can shift semantically, from an order or a command, to the meaning of a ‘destiny’ which the gods decree to humans. *Šimtu* thereby becomes one’s personal ‘destiny’, a portion given by the gods (presumably at birth), a share which, as Leo Oppenheim says, ‘determines the entire direction and temper of [one’s] life. . . . *Šimtu* thus unites in one term the two dimensions of human existence: personality as an endowment and death as a

153 LSJ, s.v. *nomos*.

154 For exposition of *šimtu*’s legal contexts, see D. Lehoux, ‘Tomorrow’s News Today’, 111 and n. 18 (bibliography).

155 A.L. Oppenheim, *Ancient Mesopotamia: Portrait of a Dead Civilization* (Chicago/London: University of Chicago Press, 1964), 202.

156 Quaegebeur, *Shai*, 44.

157 Ibid.

158 Rochberg-Halton, ‘Fate and Divination in Mesopotamia’, 365. Similar phrases in *CAD*, I.A.1, 321, *alāku* 4.c.6’: ‘*ana/ina/arki šimti alāku* to die’ (lit. ‘go to fate’).

159 *stkn š3wf mwt.f*; see Quaegebeur, *Shai*, 46–47, quoting *Urkunden IV*, 5.17; Hoffmeier in Redford, ed., *Ancient Gods*, 121, citing Lichtheim, *Ancient Egyptian Literature*, Vol. II, 13. For a parallel between the Egyptian and Mesopotamian versions of ‘he went to his fate’ (i.e. death), see S. Langdon and A. H. Gardiner, ‘The Treaty of Alliance between Ḫattušili, King of the Hittites, and the Pharaoh Ramesses II of Egypt’, *JEA* 6, no. 3 (1920): 179–205, here 188. The Egyptian text is *hn m-s3 p3y-f š3y.t*, ‘went after his fate’, in K. A. Kitchen, *Ramesseid Inscriptions, Historical and Biographical*, vol. II (Oxford: Basil Blackwell Ltd., 1979), 227.9. The treaty’s cuneiform version lacks the corresponding phrase, but a very similar Akkadian parallel exists: see Langdon and Gardiner, 188, n. 2; J. D. Schmidt, *Ramesses II: A Chronological Structure for His Reign* (Baltimore/London: The Johns Hopkins University Press, 1973), 129 and n. 100 (citing *KBo* I 8, line 16, with translation). Discussion in Quaegebeur, *Shai*, 126–27; Eyre, ‘Fate, Crocodiles’, 104–05.

160 Rochberg-Halton, ‘Fate and Divination in Mesopotamia’, 365.

fulfilment . . .¹⁶¹ Here we can hardly avoid thinking of Heraclitus' ἦθος ἀνθρώπων δαίμων¹⁶² on the one hand and *moira*, one's portion, and the daimon who administers it, on the other. In fact, Oppenheim compares *šmtu* with both *moira* and *phusis* (*šmtu* as a natural endowment).¹⁶³ As for Plato's version, choice comes before life, at least, if not during it.

In the Mesopotamian version, however, as in the Egyptian, one's personal 'fate' or 'destiny' is not fixed, but can be negotiated; the verdict may be appealed.¹⁶⁴ Mesopotamian fate is not utterly determined.¹⁶⁵ This appears to be the case also in later connotations of *šzy* (i.e., New Kingdom and after). We mentioned the appeal for more years of life in the 'Report of Wenamun'. A famous example of altering one's fate is in the Tale of the Doomed Prince, where the prince avoids his fate by the snake and, it appears, is well on his way to avoiding that of the crocodile when the story breaks off (scholarly consensus suggests a happy outcome).¹⁶⁶

3.1 *Mesopotamian Good Daimons, Fortune and Fate*

Mesopotamia also has the equivalent of good daimons. *šmtu*, unlike *Shai*, is never a god; it is only given by gods. But there are four Mesopotamian deities very like good daimons: they are protective spirits, described by Oppenheim as 'external souls'.¹⁶⁷ They have psychological components related to identity or

161 Oppenheim, *Ancient Mesopotamia*, 202.

162 D-K I, 177, Fr. B119.

163 Oppenheim, *Ancient Mesopotamia*, 202–03. See also Rochberg-Halton, 'Fate and Divination in Mesopotamia', 365 and n. 20.

164 See Lehoux, 'Tomorrow's News Today', 118, who discusses the legalistic language of *namburbi* rituals, but also their magical components. (See also Chapter 6, 1.3, 'Changing your fate', for an astrological apotropaism.)

165 Rochberg-Halton, 'Fate and Divination in Mesopotamia', 366. See also F. Rochberg, *The Heavenly Writing: Divination, Horoscopy, and Astronomy in Mesopotamian Culture* (Cambridge: Cambridge University Press, 2004), 200.

166 Lichtheim, *Ancient Egyptian Literature*, Vol. 11, 200 (the story at 200–03); also see the summary by Hoffmeier in Redford, ed., *Ancient Gods*, 122; Bleeker, 'Idée des Schicksals', 122–23. *Contra* Miosi, 'God, Fate and Free Will', 72 and esp. n. 18, whose opinion is that the dog will ultimately cause the death of the prince. But G. Posener, 'On the Tale of the Doomed Prince', *JEA* 39 (1953): 107, quotes Diodorus Siculus, *Bibliotheca historica* (1, 89.3), who relates a similar historical incident with a happy ending.

167 Oppenheim, *Ancient Mesopotamia*, 199.

to personality.¹⁶⁸ There are two masculine-feminine pairs: *ilu* and *išturu*, *šēdu* and *lamassu*.¹⁶⁹ Oppenheim tells us:

Two characteristics unite all four designations: they all have luck as an important shade of their range of meanings, and they all have some relationship to the world of the demons and the dead. To experience a lucky stroke, to escape a danger, to have an easy and complete success, is expressed in Akkadian by saying that such a person has a 'spirit', i.e., an *ilu*, *išturu*, *šēdu* or *lamassu*.¹⁷⁰ we may see in the *ilu* some kind of spiritual endowment which is difficult to define but may well allude to the divine element in man; in *išturu*, his fate; in *lamassu*, his individual characteristics; and in *šēdu*, his *élan vital*.¹⁷¹

'Luck' here is not the indeterminate 'chance' of the Greeks, but a kind of serendipitous good fortune given by the guardian spirit who has one's welfare at heart. Lamassu has a protective function similar to that of a guardian daimon: 'On the 16th of Simanu let him take the rope of a boat travelling upstream; his Lama, the one who keeps him safe, will keep guiding him.'¹⁷² Oppenheim theorises that *išturu* carries the *šimtu* of the individual.¹⁷³

The goddess Ishtar has a role in holding the power of the king and acting as his divine protector¹⁷⁴ which is called, respectively, *tuchē* and *fortuna* by the Greeks and Romans.¹⁷⁵ Ishtar correlates both to Aphrodite and Venus (and the planet Venus); and Venus rejoices in the fifth place in astrology, called *agathē tuchē*. In Hellenistic astrology, the equivalent of the *tuchē* available to

168 Ibid., 200.

169 On *šēdu* and *lamassu*, see also M. Leibovici, 'Génies et démons en Babylonie', in *Génies, anges et démons. Égypte, Babylone, Israël, Islam etc.* (Paris: Éditions du Seuil, 1971), 103–06.

170 Oppenheim, *Ancient Mesopotamia*, 200.

171 Ibid., 205–06. Oppenheim notes, 201, that the characteristics of *šēdu*, which corresponds to Sumerian *alad*, may be compared in their procreative function to the Latin *genius*.

172 H. Hunger, *Astrological Reports to Assyrian Kings* (Helsinki: Helsinki University Press, 1992), 15, No. 23, rev. 1–6; I thank Francesca Rochberg for this translation. For protective attributes of Lamassu, see *CAD IX.L*, 60–62.

173 Oppenheim, *Ancient Mesopotamia*, 205.

174 Ibid.

175 Ibid. The idea of random chance, which can be contained in the meaning of *tuchē*, does not enter the Mesopotamian picture. See Rochberg-Halton, 'Fate and Divination in Mesopotamia', 365, for a discussion of how Mesopotamian fortune does not contain the concept of chance.

the king from the goddess is given to the individual at birth by Venus and her connection to the fifth place.

Two other 'demons of some kind' should be mentioned; unlike the protective spirits described above, they are known as 'he who offers good things' (i.e., good demon) and 'he who offers misfortune' (i.e. bad demon).¹⁷⁶ Oppenheim suggests they may have something to do with success and failure, and that their Greek counterparts are *eudaimonia* and *kakodaimonia*.¹⁷⁷ The natural astrological correlation would be either to the eleventh and twelfth places, or to the fifth and sixth.

3.2 *Non-Greek Fate and Astrology*

We have, in two important neighbouring cultures to the Greeks, ideas of fate which do not bind it in chains of determinism, as the Greek *heimarmenē* does with its components of necessity and inevitability. Hellenistic astrology draws on these two cultures, Egyptian and Mesopotamian, in its development as a coherent system of divination and prediction. In addition to Manilius, the astrologers Thrasyllus, Dorotheus, Valens, Firmicus, Paulus, Hephaestio and Antigonus of Nicaea (cited on the decans by Hephaestio)¹⁷⁸ all mention Egyptian sources in their treatises, not to mention the Egyptian astrologers Teucer of Babylon, Anubio, Chaeremon, Manetho and Rhetorius. The Greek names for the fifth and eleventh places of the chart can be correlated to Egyptian counterparts which connect with Egyptian ideas of destiny. The eleventh place, and sometimes the fifth (as aphetic places), are capable of assigning the planet which controls length of life, and their names, Agathos Daimon and Agathe Tuche, have connections with *moira*.

Morenz/Müller, Thausing, Miosi, Bergman, Quaegebeur and von Lieven have discussed non-deterministic aspects of Egyptian fate.¹⁷⁹ Miosi has stated this well:

An Egyptian's future was not fixed and predestined. It was, instead, the result of a dynamic interaction between the individual—with his desires,

176 Oppenheim, *Ancient Mesopotamia*, 204. They may also compare to the Egyptian Shepset and Weryt.

177 Ibid.

178 At Hephaestio II, 18.74–75. Thanks to the anonymous reader for this observation.

179 Morenz/Müller, *Rolle des Schicksals*; Thausing, 'Der ägyptische Schicksalsbegriff'; Miosi, 'God, Fate and Free Will'; Bergman, 'I Overcome Fate'; Quaegebeur, *Shai*, 108 and n. 4; von Lieven, 'Divination in Ägypten', 115–16. Thausing, Bergman and von Lieven include astrology and/or astral omnia in their discussions.

motivations and actions—his physical and temporal environment and the gods. The divine was imminent and was always reacting to man, principally through the process of reward and punishment. When the future was revealed to a person through an oracle, he may simply have been finding out what god wanted him to do or what particular response or reaction god had in store for him . . . Divine revelation of some event in a totally static and predestined future is quite different from god's revealing to someone what his future responses will be within a dynamically interactive relationship.¹⁸⁰

Miosi has used oracles as his divinatory mode here, but we could equally well substitute astrology. Given the Mesopotamian and Egyptian roots of astrology (and we have more and more evidence of this every day, especially in the burgeoning Demotic material), and the established influence of Egyptian and Mesopotamian ideas in other disciplines,¹⁸¹ I suggest that non-deterministic ideas of destiny evident in Egyptian and Mesopotamian culture carried over into Hellenistic astrological ideas about fate.

Although some Greek astrologers talk about astrological prognostication as discovering one's already ordained fate, there are cracks in this armour of 'hard' determinism that suggest a negotiation with that fate is possible (we saw some cracks in Chapter 1).¹⁸² Katarchic astrology is the obvious form of this kind of negotiation,¹⁸³ but it can also take place within natal astrology, both in awareness of the various outcomes possible in one astrological configuration¹⁸⁴

180 Miosi, 'God, Fate and Free Will', 93–94.

181 E.g., Fowden, *The Egyptian Hermes*; W. Burkert, *The Orientalizing Revolution: Near Eastern Influence on Greek Culture in the Early Archaic Age* (Cambridge, MA: Harvard University Press, 1992, repr. 1995); M. L. West, *Early Greek Philosophy and the Orient* (Oxford: Clarendon Press, 1971); E. Iversen, *Egyptian and Hermetic Doctrine* (Copenhagen: Museum Tusulanum Press, 1984), among others.

182 For the idea of a negotiable destiny in astrology, as in divination, see Cornelius, *The Moment of Astrology*, 131, 173. Cornelius also recognises the importance of the daimon, 177–81.

183 Katarchic astrology, in fact, is purposely designed to negotiate fate; see Chapter 6, 1.1–1.4, 1.6 on *katarchai* in the PGM, and especially 1.3. N. Campion, *The Dawn of Astrology: A Cultural History of Western Astrology*, vol. 1. *The Ancient and Classical Worlds* (London: Continuum Books, 2008), 175, remarks that there are 'two ways of relating to the cosmos; one in which fate is negotiated and the other in which it is accepted' (see also 212).

184 See D. G. Greenbaum, 'Arrows, Aiming and Divination: Astrology as a Stochastic Art', in *Divination: Perspectives for a New Millennium*, ed. Patrick Curry (Farnham, Surrey: Ashgate, 2010), esp. 196–99 ('Hephaestio and Conjecture').

and in the intention and attitude of a person regarding what happens to her.¹⁸⁵ Miosi gives numerous Egyptian parallels, including this from Papyrus Insinger (5.1): ‘As for the one who is gentle through his good character, he makes his fate (šy) himself.’¹⁸⁶ As Miosi says, ‘Fate cannot act of its own accord but is commanded, sent or made to arise by the god, who is always seen as reacting to man’s good and bad actions and *intentions of heart*’ (my italics).¹⁸⁷ Though the veneer (and even several layers below) of Hellenistic astrology was Greek, underneath, at its core, assumptions about what in life is fixed, and what is not, may come from the cultures which had the most influence on the origins and development of Hellenistic astrology—the Egyptian and the Mesopotamian. Their people’s fates could be negotiated; and I propose that, despite an apparent ‘hard’ determinism, Hellenistic astrologers could and did operate under assumptions that a fate could be changed, and that astrology could be an instrument in deciding how to go about changing it. This is not to deny that Greek concepts of fate still frequently hold sway in astrological texts, but to point out that the original reasons for reading the future from the heavens in astral omina, from which Hellenistic astrology was born, did not necessarily have to follow such philosophical precepts. What may be taking place within astrology is an uneasy truce or an accommodation, perhaps both simultaneously, between two fundamentally different concepts of fate. This is why we see positions of what seem like hard determinism cheek by jowl with positions that allow choice and change within astrological practice (e.g. Valens’ different viewpoints discussed in Chapter One).

That Egyptian gods and their treatment of human fate would appeal to Greeks and Romans is not new.¹⁸⁸ The ubiquity of Isis-worship (who, among other things, can conquer fate) in the Greco-Roman world scarcely needs pointing out. A conception of fate as something given by gods who can be propitiated, as a life which can be lengthened by divine dispensation and altered based on virtuous acts (or the opposite) and intentions, might hold an attraction for those whose culture tells them that allotment is final and fate is fixed.

Hellenistic astrology is, it appears, a *de facto* battleground over the issue of determinism. It becomes a whipping boy for fatalism; but with its emphasis on

185 See Chapter 9, 5.5, the example of the dancer, 324–27; and, e.g., the desires of Valens and Firmicus to improve themselves.

186 Miosi, ‘God, Fate and Free Will,’ 97.

187 Ibid.

188 E.g., Morenz, *Egyptian Religion*, 74: ‘We shall hardly go wrong in assuming that this consoling power over fate was not the least reason for the Egyptian deities’ appeal to the Greeks and Romans.’

finding the best and strongest planets to represent the giving of years, it tries to find ways to extend life by divine planetary sanction (not completely unlike the pleading of the prince of Byblos for more years from Amun). The emphasis on the powers of *daimōn* and *tuchē* (underpinned by Shai and Shepset?) also tell us that the *technē* of astrology looked for ways to incorporate what they represent into its practice. Instead of only Greek ideas, Hellenistic astrology also follows, more than is commonly supposed, the philosophical and religious inclinations of Egyptian and Mesopotamian thought.

Hie Thee to Hell: The Place of the Bad Daimon

Hie thee to hell for shame, and leave this world,
Thou cacodemon: there thy kingdom is

SHAKESPEARE, *Richard III*, 1.3.143–144

In the ancient world, alas, if not the modern, bad daimons are as pervasive as good daimons. In Chapters Two and Three, we saw the activities of good daimons in the syncretic milieu of Ptolemaic and Roman Egypt as well as in the astrology of those periods. This chapter will first examine the bad daimon's place within a number of Mediterranean cultures, including Mesopotamian, Egyptian, Greek, Jewish and Christian. We then explore how astrologers viewed bad daimons, and their literal places in the practice of Hellenistic astrology. In this chapter, I use the word 'demon' to denote purely bad daimons, aligning with the present-day English connotation.

1 A Brief History of Bad Daimons

1.1 Mesopotamian Demons

Mesopotamia is one of the oldest civilisations to have a flourishing demonology.¹ The ubiquity and number of Mesopotamian daimons must be emphasised. Evil daimons, known in Akkadian as *utukkē lemnūti*, first appear in Sumerian texts.² Tiamat creates hordes of demons in the great creation myth, *Enuma Eliš*:

-
- 1 An excellent survey of Mesopotamian daimons is M. Leibovici, 'Génies et démons en Babylonie'; for bad daimons, see H. Limet, 'Les démons méchants de la Babylonie', in *Anges et démons: Actes du colloque de Liège et de Louvain-la-Neuve, 25–26 novembre 1987*, ed. Julien Ries and Henri Limet, *Homo religiosus* (Louvain-la-Neuve: Centre d'histoire des religions, 1989), 21–35; also see Thompson, *Devils and Evil Spirits of Babylonia*, vol. 1, xxiv–xxxviii. For primary texts, see Geller, *Evil Demons*; and W. Farber, *Schlaf, Kindchen, Schlaf! Mesopotamische Baby-Beschwörungen und -Rituale* (Winona Lake, IN: Eisenbrauns, 1989).
- 2 Oppenheim, *Ancient Mesopotamia*, 249. See M. J. Geller, *Forerunners to Udug-hul: Sumerian Exorcistic Incantations* (Stuttgart: Franz Steiner Verlag Wiesbaden GMBH, 1985).

Sharp of tooth and unsparing of fang (?).
 She filled their bodies with venom instead of blood.
 She stationed a horned serpent, a *mušhuššu*-dragon, and a *lahmu*-hero,
 An *ugallu*-demon, a rabid dog, and a scorpion man,
 Aggressive *ūmu*-demons, a fish-man, and a bull-man
 Bearing merciless weapons, fearless in battle.³

Mesopotamian demons often attacked humans through disease and death, usual vectors of the bad in many cultures.⁴ Some demons were associated with bad weather, particularly wind and storms. The vicious female demon Lamaštu attacked pregnant or labouring women and newborn babies.⁵ Pregnant women wore amulets featuring Pazuzu, another demon, who was able to ward off the attacks of Lamaštu; but Pazuzu was able to wreak his own havoc if he desired, since he ruled over the evil wind-demons.⁶

A plaque of Lamaštu and Pazuzu, now in the Louvre,⁷ shows Pazuzu overlooking Lamaštu from the top of the plaque, while other demons (possibly ‘the Seven’, who may link to planets) appear on the second row to help him expel Lamaštu.⁸

Other demons guarded the seven portals of the underworld; still others were ghosts unable to rest. A group of related demons, the *lilû* (male), *lilitu* and *ardat lilî* (both female), are concerned with dysfunctional aspects of sex

3 ‘Epic of Creation’, in S. Dalley, *Myths from Mesopotamia: Creation, the Flood, Gilgamesh, and Others* (Oxford: Oxford University Press, 1989, repr. 1991), 237 (repeated 239–40, 245).

4 See the long list of demons who cause illness in Leibovici, ‘Génies et démons en Babylonie’, 97–101.

5 See prayers to repel her in Farber, *Schlaf, Kindchen, Schlaf!*.

6 A. Green, ‘Myths in Mesopotamian Art’, in *Sumerian Gods and Their Representations*, ed. Irving L. Finkel and Markham J. Geller (Groningen: Styx Publications, 1997), 135–58, here 143.

7 The plaque appears in the following: A. Green, ‘Beneficent Spirits and Malevolent Demons’, *VRel* 3 (1984): 80–105, here described 81, depicted 96; A. E. Farkas, P. O. Harper, and E. B. Harrison, eds., *Monsters and Demons in the Ancient and Medieval Worlds: Papers Presented in Honor of Edith Porada* (Mainz on Rhine: Philipp von Zabern, 1987), Plate LIV; J. A. Black and A. Green, *Gods, Demons, and Symbols of Ancient Mesopotamia: An Illustrated Dictionary* (London: British Museum Press for the Trustees of the British Museum, 1992), 181 (with description); description in Leibovici, ‘Génies et démons en Babylonie’, 95–96. The image is online at <http://www.louvre.fr/en/mediaimages/plaque-de-conjuration-contre-la-lamashtu-dite-plaque-des-enfers>.

8 Green, ‘Beneficent Spirits and Malevolent Demons’, 81.

and procreation. The numinous powers of these demons are destructive rather than beneficial.⁹

But there are paradoxes here. Sometimes evil daimons are used apotropically (as Pazuzu with Lamaštu).¹⁰ Demons are called *ilu*, the Akkadian word for 'god'. Henry Saggs says that demons were not necessarily inferior in power to the gods, and could even surpass their power at times.¹¹ What seems to differentiate them from gods is their lack of a complete personality, along with an inability to create; but they do have the ability, unlike gods, to enter into bodies.¹² Marcel Leibovici points out their connection with the world of the dead, and with breath and wind.¹³ More than one writer has mentioned the pervasiveness and quantity of demons and their activities in Mesopotamian culture, with a subsequent cottage industry in amulets and other apotropaic measures.¹⁴ Comparisons have been made between the relative stability of Egyptian religion and culture, and the insecurity and fear prevalent in Mesopotamian culture, as reasons for the proliferation and behaviour of evil spirits in the latter.¹⁵ In Egyptian culture, all divinities are designated *ntrw*; in Mesopotamian culture, there is no special word for daimon, good or bad—what scholars call demons have a number of different names, such as *rābišu*, *utukku* and *gallū*. Edith Porada's chronology of the evolution of Mesopotamian demons outlined the creation of their forms between animal and human (she

-
- 9 T. Jacobsen, *The Treasures of Darkness: A History of Mesopotamian Religion* (New Haven/London: Yale University Press, 1976), 12–13.
- 10 See Green, 'Beneficent Spirits and Malevolent Demons', esp. 83–86. Green even argues that the protective function of evil demons was increased 'because of their malevolent background' (86).
- 11 H. W. F. Saggs, *The Encounter with the Divine in Mesopotamia and Israel* (London: University of London—Athlone Press, 1978), 97; here he refers to demons causing an eclipse by attacking Sin, the Moon god (text of *Utukki Limnūti*, Tablet XVI, in Thompson, *Devils and Evil Spirits*, here vol. 1, 92–95, ll. 70–74, 98–99).
- 12 Saggs, *Encounter with the Divine*, 97; see also M. J. Geller, 'Freud, Magic and Mesopotamia: How the Magic Works', *Folklore* 108 (1997): 1–7, here 1, who makes the same observation about lack of personality.
- 13 Leibovici, 'Génies et démons en Babylonie', 87–88.
- 14 E.g., Saggs, *Encounter with the Divine*, 96; Green, 'Beneficent Spirits and Malevolent Demons', 80.
- 15 Green, 'Beneficent Spirits and Malevolent Demons', 80; E. Porada, 'Introduction', in Farkas, Harper and Harrison, eds, *Monsters and Demons*, 3; J. B. Russell, *The Devil: Perceptions of Evil from Antiquity to Primitive Christianity* (Ithaca/London: Cornell University Press, 1977), 86; also Black and Green, *Gods, Demons and Symbols*, 9.

says demons walk on two legs, while monsters walk on four), with the changes in their iconography.¹⁶

The evil functions of Mesopotamian demons may influence the conception of Jewish demons.¹⁷ The similarities of name and function of the *lilû- lilitu* group (especially of the *ardat lilî*, who is unable to have sex) with the Jewish Lilith has not passed unremarked.¹⁸

1.2 Egyptian Demons¹⁹

Calamities caused by Egyptian demons include disease, injury and death.²⁰ Death occurred not only from the natural corruption of the body, but also by demonic influence, often through the breath.²¹ Spells to ward off illness caused by demons were commonplace.²²

-
- 16 Porada in Farkas, Harper and Harrison, eds, *Monsters and Demons*, 1–2 (the same categorisation in Black and Green, s.v. ‘demons and monsters’, but without attribution to Porada).
- 17 Russell, *The Devil*, 92; T. W. Davies, *Magic, Divination, and Demonology among the Hebrews and their Neighbours* (London: James Clarke & Co., 1898), 114–19; S. Langdon, ‘Babylonian and Hebrew Demonology with reference to the supposed borrowing of Persian Dualism in Judaism and Christianity’, *JAS* (1934): 45–56.
- 18 Black and Green, *Gods, Demons and Symbols*, 118; Russell, *The Devil*, 92; Saggs, *Encounter with the Divine*, 99; Langdon, ‘Babylonian and Hebrew Demonology’, 54; E. Langton, *Essentials of Demonology: A Study of Jewish and Christian Doctrine, Its Origin and Development* (London: Epworth Press, 1949), 16.
- 19 The use of the English word ‘demon’ is purely for convenience, as it does not exist in Egyptian. For discussion of this issue, see P. Kousoulis, ‘Introduction: The Demonic Lore of Ancient Egypt: Questions of Definition’, in *Ancient Egyptian Demonology: Studies on the Boundaries between the Demonic and the Divine in Egyptian Magic*, ed. P. Kousoulis, *OLA* (Leuven/Paris/Walpole, MA: Peeters, 2011); R. Lucarelli, ‘Demons (benevolent and malevolent)’, in *UCLA Encyclopedia of Egyptology*, ed. Jacco Dieleman and Willeke Wendrich (Los Angeles: Department of Near Eastern Languages and Cultures, UC Los Angeles, 2010), 1–3; R. Lucarelli, ‘Demonology during the Late Pharaonic and Greco-Roman Periods in Egypt’, *JANER* 11 (2011): 109–25, esp. 110.
- 20 D. Meeks, ‘Génies, Anges, Démons en Égypte’, in *Génies, anges et démons. Égypte, Babylone, Israël, Islam etc., Sources Orientales VIII* (Paris: Éditions du Seuil, 1971), 17–84, here 21. J. F. Borghouts, *Ancient Egyptian Magical Texts* (Leiden: Brill, 1978), is the standard text for magical spells against demons. For descriptions of treating illness with spells against demons, see J. Naydler, *Temple of the Cosmos: The Ancient Egyptian Experience of the Sacred* (Rochester, VT: Inner Traditions, 1996), 158–60. For demons who bring death see J. Zandee, *Death as an Enemy according to Ancient Egyptian Conceptions* (Leiden: E.J. Brill, 1960), 86–87.
- 21 Iversen, *Egyptian and Hermetic Doctrine*, 41–42.
- 22 See e.g., Spells 14–16, 18, 26–27, 30–32, 37–45, 47–58, etc. in Borghouts, *Magical Texts*.

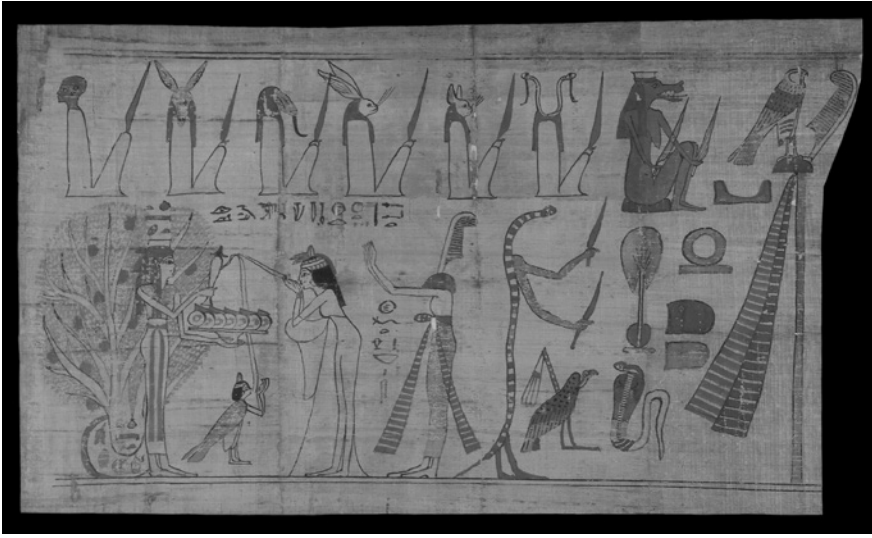

FIGURE 4.1 *Detail of the Funerary Papyrus of Taminiu, showing demons (with knives). Thebes, 3rd Intermediate Period, ca. 950 BCE.*
(© TRUSTEES OF THE BRITISH MUSEUM; USED WITH PERMISSION).

Although Egyptians believed in the possibility of eternal life after physical death, their afterworld was filled with demons trying to prevent the deceased from achieving it.²³ Stationed at the gates and crossing places of the Duat (place of the afterworld),²⁴ demons tried to keep the deceased from reaching the Hall of Osiris leading to paradise.²⁵ Only with the right charms could the deceased advance.²⁶ Apophis, a powerful snake demon who represented the chaos against which Egyptians eternally struggled, tried every day to attack the sun's bark as it moved across the sky, and every day was repulsed.²⁷ (The 35th decade on the Naos of the Decades sends the decans against Apophis

23 See the lists of 'netherworld' demons in Zandee, *Death as an Enemy*, 200–08.

24 The Duat is commonly called the 'Underworld' or 'Netherworld', but these terms are problematic in relation to its location cosmologically. In Demotic astrology, the *Imum coeli* is called the 'lake of the Duat', which orients it to the cardinal points. Likewise, the Duat itself has such a relationship.

25 Meeks, 'Demons', 105. For descriptions of the 'netherworld', see Zandee, *Death as an Enemy*, 91–97.

26 Zandee, *Death as an Enemy*, 114–25.

27 Meeks, 'Demons', 106; Morenz, *Egyptian Religion*, 168 and n. 45 (p. 323).

on behalf of Re.)²⁸ The world outside Egypt was also filled with threatening demons ready to conquer the Black Land.

We saw in Chapter Three that Egyptian deities are generally called *ntr.w*; what we here call ‘demons’ were deputised by gods to bring about evils in the world. Named from their functions, some of these were called fighters (*ḥꜣty.w*), emissaries (*ḥby.w*), messengers (*wꜣwty.w*) and wanderers (*šmꜣy.w*).²⁹ They worked in groups and had no individual names, thus distinguishing them from benevolent daimonic deities like Shai and Renenet. They went armed with knives or arrows, carrying out the commands of their gods.³⁰ Some of these link to decan stars (see Chapter Six, 3.1–3.2), which in turn become associated with the ten-day periods called decades. There is one decan for each decade, adding up to an ideal 360-day year, but decans for the five epagomenal days are added to make the roughly 365-day solar year.³¹ These last five days, outside of the ideal year, are particularly dangerous.³² Endings paradoxically bring change, and this instability applies as well to the end of the day, the end of a decade and the end of the month.³³ This association of demons with danger and instability at the end of periods of time has particular relevance for Hellenistic astrology. The twelfth place, the last place in the chart, is the place of the bad daimon, and the last bounds (terms) are ruled by malefics (see 2.5 below).

-
- 28 A.-S. von Bomhard, *The Naos of the Decades: From the Observation of the Sky to Mythology and Astrology*, trans. Ludwig von Bomhard (Oxford: Institute of Archaeology, University of Oxford, 2008), 105, 179.
- 29 Meeks, ‘Demons’, 105. *ḥꜣty.w* are also defined as ‘slaughterers’ in *Wb* III, 236 s.v., ‘schlach-tende Götter’. See also the list in Borghouts, *Magical Texts*, 117; Lucarelli, ‘Demons (benevolent and malevolent)’, 3–5, who gives two general classifications, ‘guardians’ and ‘wanderers’; A. von Lieven, *Der Himmel über Esna: eine Fallstudie zur religiösen Astronomie in Ägypten am Beispiel der kosmologischen Decken- und Architravinschriften im Tempel von Esna* (Wiesbaden: Harrassowitz, 2000), 51–54. For *ḥꜣty.w* see also Quack, ‘Dekane’, §1.1.
- 30 D. Meeks, ‘Génies, Anges, Démons en Égypte’, 44–45; Lieven, *Himmel über Esna*, 54.
- 31 See the list of decans for Epagomenal Days in Neugebauer and Parker, *EAT* III, 164–66.
- 32 See Meeks, ‘Demons’, 105; von Bomhard, *Naos of the Decades*, 181 note c, 183. Decades 36 and 37, those of the last and epagomenal decades on the Naos, seem to combine all the evils of the year into one comment on life and death, the yearly plague, the Khatyu-demons, massacres and afflictions.
- 33 Meeks, ‘Génies, Anges, Démons en Égypte’, 45–46 (and n. 170). See also Borghouts, *Magical Texts*, 12–14 (Spell 13, [Book] of the Last Day of the Year) and 14–15 (Spells 14–16, against yearly plagues); see also von Bomhard, *Naos of the Decades*, 104, who cites Borghouts. (Note that Egyptian hemerologies, however, do not seem to reflect this thinking. But Babylonian, Egyptian and Greek cultures have traditions of ominous, i.e. unlucky, days, even associated with bad daimons: see A. T. Grafton and N. M. Swerdlow, ‘Calendar Dates and Ominous Days in Ancient Historiography’, *JWI* 51 (1988): 14–42, esp. 15–16.)

1.3 *Greek Demons*

In Greece, evil spirits are associated with death in general, violent death in particular, and can be avengers of wrongs. The early spirits are not always called daimons, but go under names such as *kēr*, *alastor* or Erinys.³⁴ Such spirits appear in the plays of Aeschylus. Those denied a proper burial or killed violently could wander the earth and prey on the living. Local daimons had their own shrines and sacrifices, as Porphyry explains in *On Abstinence*:

Others [*sc.* daimons] have no name at all in most places, but acquire a name and cult inconspicuously from a few people in villages or in some cities. The remaining multitude is given the general name of *daimones*, and there is a conviction about all of them that they can do harm if they are angered by being neglected and not receiving the accustomed worship, and on the other hand that they can do good to those who make them well-disposed by prayer and supplication and sacrifices and all that goes with them.³⁵

These popular daimons seem like a different species than those generally discussed by philosophers. Plato, of course, emphasised the idea that daimons were between gods and humans, and popularised a personal daimon. His successor Xenocrates, who first articulated the concept of the three different kinds of triangles representing gods, daimons and humans,³⁶ promoted the idea that

34 See Dodds, *Greeks and the Irrational*, 39–40; idem, *The Ancient Concept of Progress and other Essays on Greek Literature and Belief* (Oxford: Clarendon Press, 1973), 55, where he says that *δαίμων*, *άλάστωρ* and *ἐρινύς* can be used interchangeably; and 56, where he explains that the evil spirit is drawn by a ‘flaw in our nature’. See also G. Luck, *Arcana Mundi: Magic and the Occult in the Greek and Roman Worlds* (Baltimore/London: Johns Hopkins University Press, 1985, repr. 1992), 165; W. Burkert, *Greek Religion*, trans. J. Raffan (Cambridge, MA: Harvard University Press, 1985, repr. 2001), 181; and R. B. Onians, *The Origins of European Thought about the Body, the Mind, the Soul, the World, Time and Fate* (Cambridge: Cambridge University Press, 1951, repr. 2000), 404–07.

35 *On Abstinence*, II, 37.4–5 (Nauck, 166.20–167.3): οἱ δὲ ὡς τὸ πολὺ μὲν οὐ πάνυ τι κατωνομάσθησαν, ὑπ’ ἐνίων δὲ κατὰ κώμας ἢ τινὰς πόλεις ὀνόματός τε καὶ θρησκείας ἀφανῶς τυγχάνουσιν. τὸ δὲ ἄλλο πλῆθος οὕτω μὲν κοινῶς προσαγορεύεται τῷ τῶν δαιμόνων ὀνόματι, πείσμα δὲ περὶ πάντων τοιοῦτόν ἐστιν, ὡς ἄρα καὶ βλάπτουεν <ἀν> εἰ χολωθεῖεν ἐπὶ τῷ παρορᾶσθαι καὶ μὴ τυγχάνειν τῆς νενομισμένης θεραπείας, καὶ ἅλιν εὐεργετοῖεν ἂν τοὺς εὐχαῖς τε αὐτοῦς καὶ λιτανείαις θυσῖαις τε καὶ τοῖς ἀκολουθοῖς ἐξευμενιζομένους. Trans. Clark, in *Porphyry. On Abstinence from Killing Animals*, trans. and annot. Gillian Clark (London: Duckworth, 2000), 70.

36 Plutarch, *De defectu* 416c–d. The equilateral triangle, with perfectly equal angles and sides, corresponds to the gods; the scalene, with no angles or sides equal, to mortals; and the isosceles, which combines the attributes of the first two triangles, being partly equal

daimons are subject to passions and therefore can be corrupted and corrupt.³⁷ This idea blossomed in Neo-Platonic circles (see Chapter Seven, 1.1, 'Plotinus'). Daimons in the *Hermetica* attract humans whose souls are not led by *nous*, and thus have immoderate desires and emotions:

All others [*i.e.*, those whose noetic part is not illuminated by the divine ray of god] are led and carried off, both souls and bodies, by the daimons, because they adore the daimons' energies and acquiesce in them. [This is a love that] misleads and is misled. And so the daimons govern this whole earthly government through the instruments of our bodies; this government Hermes has called 'fate'.³⁸

Plutarch reports Xenocrates' claim that ill-omened days and festivals with cruel and violent components were not for gods, but for 'certain great and powerful natures, obdurate, however, and morose, which take pleasure in such things' and therefore are kept from doing worse.³⁹ Well before Xenocrates, though, Empedocles claimed that daimons were punished by returning to inhabit bodies on earth, whether animals or humans.⁴⁰

A negative perception of daimons is attributed to Pythagoras: 'Pythagoras [said], in regard to the first principles, that the monad was god and the good...but the unlimited dyad was daimon and the bad.'⁴¹ Also in the *Placita* we find: 'Subsidiary to the discussion of gods, we must report

and partly unequal, to the daimons (416d). See Dillon, *Middle Platonists*, 30–33; also idem, *The Heirs of Plato: A Study of the Old Academy (347–274 BC)* (Oxford: Clarendon Press, 2003), 128–30; also Timotin, *Démonologie*, 93–99.

37 *De defectu* 416c. See H. S. Schibli, 'Xenocrates' Daemons and the Irrational Soul', *CQ New Series*, 43, no. 1 (1993): 143–67, here 147–49 and notes (his exegesis of daimons in Plato and Xenocrates).

38 *CH XVI*, 16.4–10 (Nock and Festugière, *CH*, II, 237.4–10):...οἱ δὲ ἄλλοι πάντες ἄγονται καὶ φέρονται καὶ τὰς ψυχὰς καὶ τὰ σώματα ὑπὸ τῶν δαιμόνων, ἀγαπῶντες καὶ στέργοντες τὰς ἐκείνων ἐνεργείας· καὶ τὸ λόγος οὐκ ἔρωσ' ἔστιν ὁ πλανώμενος καὶ πλανῶν· τὴν οὖν ἐπίγειον διοίκησιν ταύτην πᾶσαν διοικοῦσι δι' ὀργάνων τῶν ἡμετέρων σωμάτων· ταύτην δὲ τὴν διοίκησιν Ἑρμῆς εἰμαρμένην ἐκάλεσεν. My translation, but I have followed Copenhaver, in *Hermetica*, 61, in some phrases (and see his note to *XVI.16*, p. 207). The phrase between *crucis* was interpreted by Reitzenstein in *app. crit.*, Nock and Festugière, *CH* II, 237 as καὶ οὗτος ὁ ἔρωσ.

39 *De Iside* 361b; sim. at *De defectu* 417c, cited in Schibli, 'Xenocrates' Daemons', 147 n. 23. See also Dillon, *Heirs of Plato*, 130–31.

40 M. Detienne, 'Xénocrate et la démonologie Pythagoricienne', *REA* 60 (1958): 271–79, here 273, citing D-K I, 537–58 (Empedocles, fr. B115).

41 Pseudo-Plutarch, *Placita philosophorum* 881e (Mau, 67.9–11): Πυθαγόρας τῶν ἀρχῶν τὴν μὲν μονάδα θεὸν καὶ τάγαθόν... τὴν δ' ἀόριστον δυάδα δαίμονα καὶ τὸ κακόν...; cited in Hübner, *Dodekatropos*, 70 and n. 195.

about daimons and heroes. Thales, Pythagoras, Plato and the Stoics [all said that] daimons are actually beings of soul; heroes are souls separated from bodies, and they are good when the souls are good, but bad when the souls are inferior.⁴² Sentiments like this developed from the idea that excessive emotion, from being too much influenced by a bad daimon, led to unhappiness (*kakodaimonia*). So Posidonius says:

The cause of emotions, that is, of inconsistency and the unhappy [*lit.* ‘*cacodaimonic*’] life, is that humans do not follow their inborn daimon in all things, the daimon who is akin and of like nature to that which governs the whole cosmos; but at times they turn away and are carried off to the worse and bestial. In disregarding this they see in these things neither the cause of emotions, nor do they think correctly about happiness [*lit.*, ‘*good daimon-ness*’] and consistency. For they do not see that the primary thing for achieving this is not to be led in any way by the unreasonable, ‘*cacodaimonic*’ and godless part of the soul.⁴³

Too much passion was bad both for humans and for daimons. Posidonius asserts a great power for the daimon; this can be a force for happiness and good, but it can also be used unwisely. Always with the daimon is that element of danger, the sense of being on the edge of something overpowering and terrifying. To step off that edge, whether into irrationality and madness, or enlightenment and ecstasy, is a dangerous move.

The rise of Gnosticism, along with exposure to the bad daimons of other Mediterranean and Near Eastern cultures, increased the profile of bad daimons in Hellenistic circles (see Chapter Five). Earthly (‘*hylic*’) daimons were purely bad, and were seen as opponents to good angels. Manifestos like the

42 *Placita* 882b (Mau, 68.19–24): Παρακειμένως δὲ τῷ περὶ θεῶν λόγῳ τὸν περὶ δαιμόνων καὶ ἡρώων ἰστορητέον. Θαλῆς Πυθαγόρας Πλάτων οἱ Στωικοὶ δαίμονας ὑπάρχειν οὐσίας ψυχικᾶς· εἶναι δὲ καὶ ἥρωας τὰς κεχωρισμένας ψυχὰς τῶν σωμάτων, καὶ ἀγαθοὺς μὲν τὰς ἀγαθὰς κακοὺς δὲ τὰς φαύλας.

43 In *Placita ap. Galen* (Theiler, Fr. 417.4–11, vol. 1, 337 = Edelstein/Kidd, Fr. 187.4–11, vol. 1, 170.): ‘τὸ δὴ τῶν παθῶν αἴτιον, τουτέστι τῆς τε ἀνομολογίας καὶ τοῦ κακοδαίμονος βίου, τὸ μὴ κατὰ πᾶν ἔπεσθαι τῷ ἐν αὐτοῖς δαίμονι συγγενεῖ τε ὄντι καὶ τὴν ὁμοίαν φύσιν ἔχοντι τῷ τὸν ὅλον κόσμον διοικούντι, τῷ δὲ χεῖροني καὶ ζῳῳδει ποτὲ συνεκκλίνοντας φέρεσθαι. οἱ δὲ τοῦτο παρὶδόντες οὔτε ἐν τούτοις βλέπουσι τὴν αἰτίαν τῶν παθῶν οὔτε ἐν τοῖς περὶ τῆς εὐδαιμονίας καὶ ὁμολογίας ὀρθοδοξοῦσιν· οὐ γὰρ βλέπουσιν, ὅτι πρῶτόν ἐστιν ἐν αὐτῇ τὸ κατὰ μὴδὲν ἄγεσθαι ὑπὸ τοῦ ἀλόγου τε καὶ κακοδαίμονος καὶ ἀθέου τῆς ψυχῆς.’ See A. D. Nock, ‘Posidonius’, *JRS* 49 (1959): 1–15, here 10; also E. Rohde, *Psyche: The Cult of Souls and Belief in Immortality among the Greeks* (London: Kegan Paul, Trench, Trubner & Co., Ltd., 1925), 518 n. 60; cf. Iamblichus, *DM* IX.8 (282.6–9).

Chaldean Oracles showed earthly demons engaged in battle with higher ones to pull human souls either up to the divine or down into the depths.⁴⁴ Theurgic initiation could insulate initiates from these hylic demons and secure a heavenly destiny.⁴⁵ Some tenets of Chaldean demonology may originate in Iranian theology with its stark distinctions between good and evil; the Iranians call Ahriman 'Hades' and 'prince of the demons', and this conception spreads westward to become part of the Chaldean doctrine.⁴⁶ The emphasis of the Chaldeans on the badness of *hulē* reinforces the evil of the hylic demons; the influence of the Chaldean Oracles on the development of Neo-Platonism thus includes this demonisation of matter, and the thorough vilification of earthly demons—each, matter and demon, reinforcing the badness of the other. Neo-Platonists also take up the idea of demonic possession, which until this time had been more or less unheard of in the Hellenistic environment.⁴⁷ Evil is no longer a privation of good, but an actual malevolent force personified by evil daimons.⁴⁸ The idea of demonic possession in general, though, owes much to Jewish and Christian conceptions. The early-fifth century Bishop of Ptolemais, Synesius, writes of demonic assaults on the soul:

But when matter moves her own offspring into the battle for the soul, the counter-attack then becomes diminished because the gods are far away; for each is strong in its own domains. First, [the demons] wish to make you one of themselves. The attack is like this: it is not possible for anything on earth not to have an irrational part of the soul. . . . In making

44 H. Lewy and M. Tardieu, ed., *Chaldaean Oracles and Theurgy: Mysticism, Magic and Platonism in the Later Roman Empire* (Paris: Études augustiniennes, 1978), 260, citing Psellus.

45 Ibid., 266: 'As the theurgists conceived it, Destiny is a power thought of as personal, which becomes individualised in its demonic satellites. The immediate effect of the Chaldaean initiation was to eliminate this danger.'

46 Ibid., 282–88, esp. 283, and notes. I use 'Chaldean' here in reference to the Chaldean Oracles. For Iranian connections, see Lewy's citations of F. Cumont, *Les religions orientales dans le paganisme romain* 4th ed. (Paris: Librairie Orientaliste Paul Geuthner, 1929) (see esp. 141–43); J. Bidez and F. Cumont, *Les mages hellénisés: Zoroastre, Ostanès et Hystaspe d'après la tradition grecque*, 2 vols. (Paris: Société d'éditions 'Les Belles lettres', 1938).

47 See the long and thorough discussion of this phenomenon in E. C. Clarke, *Iamblichus' De mysteriis: A manifesto of the miraculous* (Aldershot/Burlington, VT/Singapore/Sydney: Ashgate Publishing Co., 2001), 72–75 and notes. I am differentiating the divine possession of, say, the Pythia at Delphi, from possession by evil forces; and even evil 'possession' in Aeschylus is not comparable to later conceptions.

48 Ibid., 74.

their betrayal, the demons come to the living through this irrational part, as it is akin to them.⁴⁹

Here, in addition to the badness of matter emphasised in the Chaldean Oracles, is the influence of earlier Xenocratian and Posidonian concepts of demons connected with irrationality.

In the Chaldean Oracles, good daimons (*iunges* and *sumbola*) are directed by Hecate.⁵⁰ Bad daimons, who are earthly (hylic), are assigned not to Hecate (their traditional ruler) but to Nature (*Physis*), thus reinforcing the idea of the material world as base. Unlike the hylic daimons, the good ones become mediators between gods and men.⁵¹ The bad daimons, the 'daemon-dogs',⁵² who are put in the service of magicians, are associated with souls who, because of the circumstances of their human's death (untimely, or violent), are unable to go to Hades and are trapped on the earth above.⁵³ These souls have no rest, cannot get into the underworld, and therefore are ripe for mischief.

Astrology provides some evidence of a connection between those who die an untimely or, especially, a violent death, and the bad, earthly daimons who wander the earth causing pain and hardship.⁵⁴ Violent death is a frequent topic, often linked with the twelfth 'Bad Daimon' place. Among numerous examples is: '... if you find both the Sun and the Moon in the sixth or the eighth or the twelfth and the malefics aspect [them], then they indicate death when their degrees conjoin with the malefics'.⁵⁵ The *Liber Hermetis* devotes a whole

49 Synesius, *Aegyptius, sive De Providentia*, I, 10, 99d–100a (Terzaghi, vol. II, 83.13–18, 20–21): ἀλλ' ὅταν εἰς πόλεμον ψυχῆς ὕλη κινήσῃ τὰ οικεῖα βλαστήματα, σμικρὸν γίνεται θεῶν ἀπόντων το ἐντεῦθεν ἀντίπαλον· ἰσχυρὸν γὰρ ἕκαστον ἐν τοῖς οικείοις. οἱ δὲ πρῶτον μὲν ἐθελήσουσιν ἑαυτῶν ποιῆσαι· ἢ δὲ ἐπιχειρήσῃς τοιάδε. οὐκ ἔστιν ἐπὶ γῆς εἶναι μὴ τινα καὶ μοῖραν ψυχῆς ἄλογον ἔχοντα... διὰ ταύτης ὡς διὰ συγγενοῦς ἐπὶ τὸ ζῶον ἔρχονται δαίμονες προδοσίαν ποιῶντες. Cited in Lewy and Tardieu, *Chaldean Oracles and Theurgy*, 306. For more on this treatise, see J. Bregman, 'Synesius, the Hermetica and Gnosis', in *Neoplatonism and Gnosticism*, ed. Richard T. Wallis and Jay Bregman, assoc. (Albany: State University of New York Press, 1992), 85–98, here 88.

50 S. I. Johnston, *Hekate Soteira* (Atlanta: Scholars Press, 1990), 106–10.

51 *Ibid.*, 91–93; also 34–35.

52 *Ibid.*, 134, referring to frs 90, 91, 135 and 156 of the Chaldean Oracles (see Julian, *Chaldean Oracles: Text, Translation, Commentary*, ed. Ruth Dorothy Majercik, (Leiden/New York: Brill, 1989).

53 Johnston, *Hekate Soteira*, 136, who states this association is present at least by the time of the magical papyri, perhaps earlier.

54 See Dodds, *Ancient Concept of Progress*, 206–07; also Sfameni Gasparro, 'Daimôn and Tuchê', 7.

55 Dorotheus, *Carmen Astrologicum* III, 1.70 (Pingree, 241).

chapter to violent death, including this: ‘Saturn in the Part of Fortune and Mars in the Part of Daimon make the figure worse, indeed they become epileptics and die violently (*biothanatos*).’⁵⁶ Rhetorius claims: ‘If the lords of the new or full Moons are found in this place [*the twelfth*], proclaim that the figure is evil; for it makes those who are banished or die violently.’⁵⁷

Epilepsy and other mental disturbances, even fever-induced delirium, were linked to bad daimons.⁵⁸ In astrology, the Bad Daimon and Fortune places are associated with injury and illness, both physical and mental.

1.4 *Jewish Demons*⁵⁹

In early Jewish tradition, as in Mesopotamian, demons are everywhere and numerous.⁶⁰ The concept that demons are capricious and lie in wait for victims in isolated places also aligns with the pre-Islamic Arabic tradition.⁶¹ The Old Testament describes demons such as קטב Qeteb (Destruction), דבר

56 *Liber Hermetis*, 36.24 (Feraboli, 239.90–91): Saturno in parte fortunae et Marte in parte daemonis peior figura fit; epileptici quidem et biothanati fiunt. It is unclear whether this refers to lots or to the places, because sect seems to be a consideration. The opposite, ‘if Saturn is in the place of the Daemon, but Mars in the place of Fortune, they make a more human figure’ (Feraboli, 239.91–93): ‘Si vero Saturnus <fuerit> in loco daemonis, Mars vero in loco [partis] fortunae, humaniorem figuram faciunt’ suggests that Saturn is above the horizon (i.e., diurnally placed) and Mars below the horizon; both agreeing with their sect and making a better outcome. It is also unclear whether, if the reference is to places, the 5th/11th or 6th/12th is meant.

57 Rhetorius, *CCAG VIII/4*, 127.17–19: ἐὰν δὲ οἱ κύριοι τῶν συνόδων ἢ πανσελήνων εὐρεθῶσιν ἐν τούτῳ τῷ τόπῳ, κακὸν τὸ σχῆμα πρόλεγε· ἐκπτῶτους γὰρ ποιεῖ ἢ βιοθανάτους.

58 Dodds, *Greeks and the Irrational*, 65–68 and notes, 83–84.

59 Again, the use of the word ‘demon’ in this section is a convenience for a concept not necessarily equivalent to our connotation of demon. For a study on OT characterisations of ‘demons’, see J. M. Blair, *De-Demonising the Old Testament. An Investigation of Azazel, Lilith, Deber, Qeteb and Reshef in the Hebrew Bible* (Tübingen: Mohr Siebeck, 2009).

60 Langton, *Essentials of Demonology*, 12, who notes the similarity to Mesopotamian demons. K. van der Toorn, B. Becking, and P. W. van der Horst, eds., *Dictionary of Deities and Demons in the Bible*, 2nd rev. ed. (Leiden/Boston/Grand Rapids, MI: Brill; Eerdmans, 1999), 236, col. 2, compares the seven evil gods who cause lunar eclipses in Mesopotamia (see H. W. F. Saggs, *The Greatness that was Babylon* (London: Sidgwick and Jackson, 1962), 302–03) to the seven evils in Deut. 28:22 (these are various plagues and extreme weather conditions).

61 See J. Henninger, ‘Beliefs in Spirits among the Pre-Islamic Arabs’, 30–33, 35, and notes. Also see H. B. Macdonald and H. Massé, ‘Djinn’, in *The Encyclopaedia of Islam, New Edition*, vol. 11 (Leiden: E. J. Brill, 1965), 546–48, esp. 547.

Deber (Plague)⁶² and רשף Resheph (Flame, the Canaanite plague demon),⁶³ as well as Lilith.⁶⁴ In fact, all Mediterranean cultures see such beings as the causes of illness, famine, plague, destruction, etc.

The *šēdu*, both good and evil in Babylonian culture, become שְׁדִים (*šēdîm*) in Hebrew, perhaps solely evil (Lilith is said to be their mother),⁶⁵ but may also be understood less negatively as ‘spirits’ different from God, in Deuteronomy 32:17: ‘they sacrificed to *šēdîm* [that are] not God’⁶⁶ (the apocryphal Baruch 4:7 repeats the same phrase in Greek);⁶⁷ and Psalm 106:37 (LXX 105:37): ‘they sacrificed their sons and daughters to *šēdîm*’.⁶⁸ There seems no vehement negativity in the connotation of *šēdîm* here. They are spirits which, because they are not God, must not be worshipped or sacrificed to, but they are not specifically evil in themselves; they are only evil in that they are not God.⁶⁹

As Caquot points out, no single word in the Old Testament can be uniformly translated as ‘demon’; bad spirits are individually identified as maladies, evil powers sent by God and doing his bidding.⁷⁰ They are conceptually different from the *šēdîm* of Deuteronomy or the Psalms. In the post-Exilic period, the idea of an evil opponent to a good God takes root and fosters the concept of Satan.⁷¹ But only in the intertestamental period, with the translation of Hebrew texts into Greek, and the currents of dualism circulating from the Zoroastrians

62 Langton, *Essentials of Demonology*, 48–50; also *DDD*, s.v. ‘Demon’, 236–37. Qeteb is found in Psalm 91 and Deuteronomy 32:24; Deber in Psalm 91, Habbakuk 3:5. (Hebrew transliteration follows the convention of the *DDD*.) See also Blair, *De-Demonising the Old Testament*, whose argument is that these originally were not demons in the conventional sense.

63 *DDD*, 237, col. 1, citing Hab. 3:5; Russell, *The Devil*, 215. Again, see Blair, *De-Demonising the Old Testament*.

64 See Russell, *The Devil*, 215; Langton, *Essentials of Demonology*, 47–48; J. Bril, *Lilith ou La mère obscure* (Paris: Payot, 1981), 56–75; the contrary view of Blair, *De-Demonising the Old Testament*.

65 Langton, *Essentials of Demonology*, 48, 51.

66 יִזְבְּחוּ לְשֵׂדִים לֹא אֱלֹהִים. Thanks to Meira Epstein for the English translation, checking the Hebrew and other advice.

67 . . . θύσαντες δαίμονις καὶ οὐ θεῷ: ‘sacrificing to demons and not to God’. Note the variation in meaning from the Hebrew, which is more ambiguous. See also *DDD*, 238, col. 1.

68 וַיִּזְבְּחוּ אֶת בְּנֵיהֶם וְאֶת בְּנוֹתֵיהֶם לְשֵׂדִים. Thanks to Cornelia Linde for helping me with the Hebrew text.

69 A. Caquot, ‘Anges et démons en Israël’, in *Génies, anges et démons. Égypte, Babylone, Israël, Islam etc.* (Paris: Éditions de Seuil, 1971), 113–52, here 117, agrees.

70 *Ibid.*, 118.

71 For Satan in the OT, see Langton, *Essentials of Demonology*, 52–55; also Russell, *The Devil*, 189–91.

and other quarters like Qumran,⁷² does the full flowering of Jewish demons as evil entities occur. In the Septuagint, spirits like the *šēdīm*, idols like the אֱלִילִים (*'elilim*) (Psalm 96:5, LXX Psalm 95:5) and more typical demons like Qeteb and Deber all become translated as *daimonia*, with implicit negativity.⁷³

In Isaiah (65:11), the Hebrew גַּד (Gad) translates the pagan Fortune: 'But you who forsake God, and neglect my holy mountain, who spread a table for Fortune and fill bowls of mixed wine for Destiny.'⁷⁴ The Hellenistic cults of Tyche and Daimon are clearly meant here.⁷⁵ Gad, the Jewish 'deity of good luck',⁷⁶ represents Tyche, a literal feast to the riches of fortune. At Greek banquets, toasts before drinking mixed wine were raised 'to the Good Daimon',⁷⁷ here represented by the Hebrew word for Destiny, מְנִי (*meni*).⁷⁸ (The next verse

72 For Zoroastrians, *DDD*, 238, col. 1; for Qumran, Russell, *The Devil*, 212–14.

73 *DDD*, 238, col. 1. See also Blair, *De-Demonising the Old Testament*, 11–12.

74 ואתם צזבי יהוה השכחים את הר קדשי הצרכים לגד שלתן והממלאים למני ממסך. Trans. in J. Blenkinsopp, *Isaiah 56–66: A New Translation with Introduction and Commentary*, vol. 19B (New York/London: Doubleday, 2003), 274 (modified). The Book of Isaiah was apparently written in three parts: chapters 1–39 are agreed to be by one author, i.e. 'Isaiah'. Chapters 40–55 and 56–66 were composed by 'Deutero-' and 'Trito-' Isaiah (see Blenkinsopp, *Is 56–66*, Introduction, esp. 38–40, 55–60). The Book of Isaiah spans a large historical framework. The later chapters, i.e. 40–66, are generally presumed to be post-Exilic; and the work as a whole may have been assembled in the post-Exilic period, probably the fifth century BCE (P. D. Miscall, *Isaiah* (Sheffield: JSOT Press [Sheffield Academic Press], 1993), 10–11) or even later, in the Hellenistic period (Blenkinsopp, *Is 56–66*, 35). Such dating is compatible with a reference to the cults of Tyche and Daimon, which were coming to prominence at that time. See commentaries on this verse in *DDD*, 340, col. 2 (s.v. 'Gad'); 567, col. 1 (s.v. 'Meni'); and Blenkinsopp, *Is 56–66*, 278–79.

75 Since the original publication of my Ph.D. thesis in 2009, Joachim Schaper independently came to the same conclusion: J. Schaper, 'God and the Gods: Pagan Deities and Religious Concepts in the Old Greek of Isaiah', in *Genesis, Isaiah and Psalms: A Festschrift to Honour Professor John Emerton for his Eightieth Birthday*, ed. Katharine Dell, Graham Davies, and Yee Von Koh (Leiden: Brill, 2010), 146–48. He based his conclusion in part on the similar opinion of I. L. Seeligmann, *The Septuagint Version of Isaiah: A Discussion of its Problems* (Leiden: E. J. Brill, 1948; reprint, Tübingen: Mohr Siebeck, 2004), 99, repr. p. 264, whose analysis I did not see at the time. It is, however, obvious to anyone who has studied the cults of Tyche and Daimon in Alexandria that these two were intentionally placed together in the text.

76 *DDD*, s.v. 'Gad', 339: 'Gad is the name of a deity of good luck, equivalent to the Greek Tyche and Latin Fortuna.'

77 See the references in LSJ, s.v. δαίμων, II.3; also Sfameni Gasparro, '*Daimôn* and *Tuchê*', 78–79.

78 S. Ribichini, in *DDD*, 340, col. 2, says: '... [Meni] is to be interpreted as a god (or spirit) of fate ...' but apparently is not aware of the cult of Agathos Daimon prevalent at the time.

gives the outcome of this blasphemous behaviour, using a pun: they will be ‘destined to the sword’.)⁷⁹ Plainly the Hebrew writer knew of the connection of Daimon to destiny and toasting with wine, and even that Fortune and Daimon’s cults were often linked. But the Septuagint reverses Fortune and Daimon, calling Gad ‘Daimon’ and Meni ‘Tyche’: . . . και ἐτοιμάζοντες τῷ δαίμονι τράπεζαν και πληροῦντες τῆ τύχη κέρασμα.⁸⁰ There is bilingual evidence (Palmyrene Aramaic-Greek) equating Gad with Tyche,⁸¹ as well as iconographic evidence (see e.g., the Gad Tadmor [Gad of Palmyra] relief from Dura-Europos).⁸² The Septuagint translation appears to be the impetus for connecting Gad with daimon, and subsequent attributions along those lines. This is another example of the confusion of Tyche and Daimon.

Psalm 91:6 (LXX 90:6) mentions the ‘בִּקְטֵב *qeteb* (destruction) that ravages at noonday’; Qeteb is a ‘noonday demon’,⁸³ but like *šēdīm*, etc., translated in Greek and Latin as δαίμωνιον/*daemonium*. (In Rabbinical literature Qeteb is ‘poisonous . . . covered with scales and with hair’ who operates during the middle part of the day in midsummer.)⁸⁴ These kinds of Jewish demons become mainly identified with sickness, plague, destruction and death. They can also

-
- 79 The pun is in the repetition of the letters ‘mn’ as in *mni*, destiny and the verb *mnh*, ‘assign’, ‘apportion’; see Blenkinsopp, *Is* 56–66, 279; *DDD*, 567, col. 1.
- 80 I disagree with Sperling’s translation of the Hebrew in the *DDD*, 567, col. 1 (s.v. Meni), rendering Gad as ‘luck’ and Meni as ‘Fortune’ (in fact, luck is an attribute of Fortune, not Daimon), thus seeming to legitimise the equation of Gad with Daimon, not Tyche, based on the Septuagint translation. But E. Ben Yehuda, *Thesaurus totius hebraicitatis et veteris et recentioris* (Jerusalem/Berlin-Schöneberg: Langenscheidt, 1959), vol. 6, 3096, calls Meni ‘the divinity of fortune (מְנִי) and fate (מְנִי)’, seemingly conflating the two terms. A. Even-Shoshan, *Ha-milon ha-hadaš*, 8 vols. (Jerusalem: Kiryat-sefer, 1974), vol. 4, 1395, gives the origin of Meni as ‘perhaps from מְנִי (fraction), i.e., מְנִי (fraction, lot, destiny)’—not unlike the Greek etymology of δαίμων from δαίωμα. Many thanks to Josefina Rodríguez Arribas for looking up and translating these entries for me.
- 81 See *DDD*, 340, col. 2 and Blenkinsopp, *Is* 56–66, 278. The text appears in G. A. Cooke, *A Text-Book of North-Semitic Inscriptions: Moabite, Hebrew, Phoenecian, Aramaic, Nabataean, Palmyrene, Jewish* (Oxford: Clarendon Press, 1903), 267–69, no. 112; *CIS* II.3, 3927; *PAT* no. 0273 (*non vidi* *CIS*, *PAT*); T. Kaizer, ‘De Dea Syria et aliis diis deabusque (Part 1)’, *OLP* 98 (1997): 147–66, here 152–54. The bilingual text (from Kaizer, 153) is (Greek, line 6) ‘. . . και Τύχη Θαμείος . . .’ and (Aramaic, line 4) ‘w[g]d tmyy’.
- 82 Dirven, *The Palmyrenes of Dura-Europos*, 102–03, which points out the similarities with the Tyche of Antioch.
- 83 See, for noonday demons, Caquot, ‘Anges et démons en Israël’, 116 and n. 3 (p. 147). Also above, n. 62.
- 84 Langton, *Essentials of Demonology*, 49–50. See also Caquot, ‘Anges et démons en Israël’, 116, for a discussion of the demon in Psalm 91.

possess people; Solomon and Jesus, for example, become masters at exorcising demons. Demonic possession is rare in other Mediterranean cultures: demons attack, and can be removed, but they do not necessarily possess in the sense meant in the Jewish and Christian traditions.⁸⁵

Different origins are supposed for demons. They can be the unjustly-treated vengeful dead, or ghosts of the wicked dead.⁸⁶ But another idea also takes root: that demons are the offspring of evil angels who mated with human women.⁸⁷ This idea engenders a link between Jewish demons and astrology in the *Book(s) of Enoch*, a collection of treatises whose earliest books are the *Astronomical Book* and the *Book of the Watchers*.⁸⁸ The *Book of the Watchers* contains the story that angels of the highest order came to earth and produced offspring with the 'daughters of earth' (1 En. 6.2). From these Nephilim (giants) came a race of demons to plague humanity.⁸⁹ In addition, the angels gave humans knowledge of divination, including 'the auguries of the stars . . . sun . . . moon'

85 For more on possession in the ancient Near East, see E. Sorensen, *Possession and Exorcism in the New Testament and Early Christianity* (Tübingen: Mohr Siebeck, 2002). He discusses the difference between 'indwelling' and 'exterior' possession (31–32, 77). Only one example in the Udug-hul rituals refers to a demon as being within a person's body (32, citing Geller, *Udug-hul* v11.669–674). Even the *namburbû* rituals, which are called exorcistic (J. Bottéro, *Mesopotamia: Writing, Reasoning and the Gods*, trans. Zainab Bahrani and Marc Van De Mieroop (Chicago/London: University of Chicago Press, 1992), 142) and which use substitution to transfer the demon's attack to another object, do not have the force or moralistic slant of Jewish (and Christian) exorcism. Sorensen also examines the influence of Zoroastrianism and its concepts of good and evil on early Judaism (45 and n. 111, 118). He makes the point that 'exorcism appears to presuppose a belief in evil as a self-willed entity' (223). In Egypt, the first case of apparent demonic possession (the Bentresh Stela) is probably either of the Persian or Ptolemaic period (and thus may be influenced by Persian elements) (see Lichtheim, *Literature*, Vol. 111, 90–94; G. Pinch, *Magic in Ancient Egypt* (Austin: University of Texas Press, 1995), 45). But whether this is analogous to Jewish demonic possession is doubtful.

86 DDD, 238, col. 2, citing respectively the Biblical Rephaim and Josephus, *Bellum Judaeorum*, 7.185.

87 Caquot, 'Anges et démons en Israël', 143–44; Langton, *Essentials of Demonology*, 107–11; DDD, 238, col. 2.

88 A. Y. Reed, *Fallen Angels and the History of Judaism and Christianity: The Reception of Enochic Literature* (Cambridge: Cambridge University Press, 2005), 3. They date from the 3rd century BCE, and form part of the Enochian writings from Ethiopia known as 1 *Enoch*. Copies in Aramaic have been found at Qumran: Reed, 18; M. Black, *The Book of Enoch or 1 Enoch: A New English Edition*, Appendix by Otto Neugebauer (Leiden: E. J. Brill, 1985), 9–10.

89 Description in Black, *Book of Enoch*, 13–14.

(1 *En.* 8.3). The angels were punished for revealing these mysteries to the unworthy (1 *En.* 18.14–16, 21.1–10). However Enoch, as a wise man, was told the secrets of the heavens and the cycles of heavenly bodies as examples for humans of order and steadfastness.⁹⁰ (His instruction occurs in the *Astronomical Book*, chapters 72–82.)⁹¹ When ‘fallen’ angels create demons (at second hand) and pass on forbidden knowledge of astrology,⁹² they almost become like demons themselves in the harm they do. A number of Christian authors (of whom Justin is prominent) take up these texts to emphasise several points: the role of fallen angels in creating demons; their transmission of illicit knowledge, especially astrology, magic and other forms of divination; and that the pagan gods are demons.⁹³ These will be important arguments in the demonisation of the daimon by the Christians.

Some pseudepigraphic texts of Solomon deal with astrology and daimons: the *Testament of Solomon* and the *Hygromanteia of Solomon*. In the *Testament* (written in Greek, probably in the early centuries CE)⁹⁴ the daimons are all evil, though they are forced to do good work building the Temple. Though the *Testament* is mainly a demonological work, showing Solomon’s ability

90 Reed, *Fallen Angels*, 41.

91 See O. Neugebauer and M. Black, *The ‘Astronomical’ Chapters of the Ethiopic Book of Enoch (72 to 82)* (Copenhagen: Det Kongelige Danske Videnskabernes Selskab, 1981) (the same in Black, *Book of Enoch*, Appendix A).

92 A parallel in the Nag Hammadi treatise *On the Origin of the World*, 124: B. Layton, ed., *Nag Hammadi Codex II, 2–7, together with XIII, 2**, *Brit. Lib. Or. 4926(1) and P. Oxy. 1, 654, 655 with contributions by many scholars*, 2 vols., vol. 2, Nag Hammadi Studies (Leiden/New York/Copenhagen/Cologne: E. J. Brill, 1989), 82–83 speaks of angels populating the world with demons, teaching magic and working with fate. See the intersection of Enoch and Gnosticism in A. Mastrocinque, *From Jewish Magic to Gnosticism* (Tübingen: Mohr Siebeck, 2005), 55–58 (he incorrectly cites *Origin of the World* 123; 124 is correct).

93 Reed, *Fallen Angels*, 174–75 and n. 29.

94 See the chronology of Dennis C. Duling in J. H. Charlesworth, *The Old Testament Pseudepigrapha*, vol. 1, *Apocalyptic Literature and Testaments* (London: Darton, Longman & Todd, 1983), 940–43. See also, for a historical survey of the *Testament*, S. I. Johnston, ‘The Testament of Solomon from Late Antiquity to the Renaissance’, in *The Metamorphosis of Magic from Late Antiquity to the Early Modern Period*, ed. Jan N. Bremmer and Jan R. Veenstra (Leuven: Peeters, 2002), 35–49. Scholarly consensus is that it was written by a Greek-speaking Christian: see Charlesworth, *Old Testament Pseudepigrapha*, 943 (translation and commentary of the *Testament of Solomon* by D. C. Duling). But its roots are found in most of the cultures of the Near East: see K. von Stuckrad, *Das Ringen um die Astrologie: Jüdische und christliche Beiträge zum antiken Zeitverständnis* (Berlin/New York: Walter de Gruyter, 2000), 394–420. See also P. A. Torijano, *Solomon the Esoteric King: From King to Magus, Development of a Tradition* (Leiden/Boston: Brill, 2002), 144–50.

to call forth and master the demons, it also contains significant astrological portions: Chapter 18 deals with decans as demons,⁹⁵ and Chapter 8 with planetary or starry demons. In Chapter 8, Solomon continues calling demons to appear before him, but instead of one, seven bound together appear. Although he requests a 'demon', these seven are not called *daimones* but rather 'spirits' (πνεύματα), reflecting the Hebrew רוּחַ, *ruah*.⁹⁶ That there are seven implies they are planets, and they call themselves 'stars in heaven' and 'named like gods'⁹⁷ (though McCown suggests not planets but the Pleiades).⁹⁸ The spirits are called *stoicheia* ('we are elements, world-lords of darkness'),⁹⁹ a word first used for 'element' (i.e. fire, earth, air and water) in Plato (*Timaeus* 48b), and further developed by Aristotle (*De generatione et corruptione*, II, 2–8). This connection with the material elements would mitigate any divine status. 'World-lords' (κοσμοκράτορες) is also an astrological term, referring both to the luminaries as overall planetary rulers and to the planets themselves.¹⁰⁰ Thus the 'spirits' are material (like daimons), tied to the material world, and

95 See Chapter 6, 3.3, 222. For a discussion of the demonology and astrology in the Testament, see M. Popović, *Reading the Human Body: Physiognomics and Astrology in the Dead Sea Scrolls and Hellenistic-Early Roman Period Judaism* (Leiden/Boston: Brill, 2007), 199–202; a briefer discussion in P. S. Alexander, 'Contextualizing the Demonology of the Testament of Solomon', in *Die Dämonen. Die Dämonologie der israelitisch-jüdischen und frühchristlichen Literatur im Kontext ihrer Umwelt. Demons: The Demonology of Israelite-Jewish and Early Christian Literature in Context of their Environment*, ed. Armin Lange, Hermann Lichtenberger, and K. F. Diethard Römheld (Tübingen: Mohr Siebeck, 2003), 631–32.

96 See Popović, *Reading the Human Body*, 195–96.

97 *Test. Sal.*, VIII.4 (McCown, 32*): «...τὰ ἄστρα ἡμῶν ἐν οὐρανῷ...», «...ὡς θεοὶ καλοῦμεθα...».

98 C. C. McCown, *The Testament of Solomon, edited from Manuscripts at Mount Athos, Bologna, Holkham Hall, Jerusalem, London, Milan, Paris and Vienna* (Leipzig: J. C. Hinrichs, 1922), 70 (cited by Duling, in Charlesworth, *Old Testament Pseudepigrapha*, 970, n. 8a (cont. from p. 969). See also the discussions in P. Busch, *Das Testament Salomos. Die älteste christliche Dämonologie, kommentiert und in deutscher Erstübersetzung* (Berlin/New York: Walter de Gruyter, 2006), 145–53 and Stuckrad, *Das Ringen um die Astrologie*, 403–15; also K. von Stuckrad, 'Jewish and Christian Astrology in Late Antiquity—A New Approach', *Numen* 47 (2000): 1–40, here 17–18; Popović, *Reading the Human Body*, 200.

99 *Test. Sal.*, VIII.2 (McCown, 31*): «ἡμεῖς ἐσμεν στοιχεῖα κοσμοκράτορες τοῦ σκότους.» The decans are also called στοιχεῖα and κοσμοκράτορες τοῦ σκότους in XVIII.1–3.

100 Valens, e.g. IX, 16.2 (Pingree, 345.10) uses it of the Sun and Moon; Iamblichus (*DM* IX.9), Proclus (e.g. the commentaries on *Republic* and *Timaeus*) and Damascius (e.g. *On Parmenides*) use it of the planetary gods. In PGM III.135 and IV.1599, Helios is called 'cosmocrator'; Hermes is 'cosmocrator' in PGM V.399 and XVIb.1.

(therefore?) products of darkness, not light. The qualifier ‘darkness’ makes it clear that they are to be considered evil¹⁰¹ (most of their names do as well: Deceit, Discord, Clotho, Distress, Error, Power and Most Evil).¹⁰² ‘Clotho’ (as the weaver of *moira*) must allude to fate carried by the demons, while ‘Power’ is a word used to describe demons in the New Testament.¹⁰³ A passage of the Gnostic tractate *On the Origin of the World* even cites the ‘Book of Solomon’ (the names are similar but not exact).¹⁰⁴ It is difficult to assign these definitively to each planet, though ‘Most Evil’ could be Saturn, Power could be Jupiter or the Sun, Discord could be Mars, Clotho or Distress the Moon, Deceit Venus and Error Mercury. Perhaps, as von Stuckrad, we should not try to pin down exactly what kind of astral entities they are.¹⁰⁵

The *Hygromanteia* of Solomon deals with both demons and astrology. Pablo Torijano made a major study of the text, providing a critical edition and translation,¹⁰⁶ so I shall just give some points of interest. The text is Byzantine but its content reflects an earlier tradition, perhaps from the early centuries CE.¹⁰⁷ It is both magical and astrological: the days and hours of the planets are given so as to be able to make a proper divination through water (*Hygromanteia*), aligned with the event desired. The planetary days and hours are the standard ones of Greek astrology.¹⁰⁸

101 ‘World-lord(s) of darkness’ is commonly used in Christian writings to refer to Satan and demonic powers. See e.g., the well-known passage in the Epistle of Paul to the Ephesians, 6:12.

102 *Test. Sal.* VIII.3 (McCown, 31*–32*): καὶ φησιν ὁ πρῶτος· «ἐγὼ εἰμι ἡ Ἀπάτη.» ὁ δεῦτερος· «ἐγὼ εἰμι ἡ Ἐρις.» ὁ τρίτος· «ἐγὼ εἰμι ἡ Κλωθώ.» ὁ τέταρτος· ἐγὼ εἰμι ἡ Ζάλη.» ὁ πέμπτος· «ἐγὼ εἰμι ἡ Πλάνη.» ὁ ἕκτος· «ἐγὼ εἰμι ἡ Δύναμις.» ὁ ἕβδομος· «ἐγὼ εἰμι ἡ Κακίστη.

103 Russell, *The Devil*, 236.

104 *On the Origin of the World*, 101.25–102.5; 106.27–107.3 (citing Solomon); in M. Meyer, ed., *The Nag Hammadi Scriptures: The International Edition* (New York: HarperCollins, 2007), 205, 208; cited in Torijano, *Solomon the Esoteric King*, 146, 184–86.

105 Stuckrad, ‘Jewish and Christian Astrology’, 18: ‘The seven stoicheia—heavenly bodies, planets or just evil entities . . .’

106 Torijano, *Solomon the Esoteric King*, 151–75; text and translation in Appendix 1. The Greek text of Ms. *Monacensis* 70 is in *CCAG* VIII/2 (Joseph Heeg, 139–65).

107 *Ibid.*, 174.

108 In the *Hygromanteia*, some concessions to Jewish practice are made in reference to the days, which are mostly numbered; Friday is the ‘day of preparation’ (Ἡμερὰ παρασκευῆ) and Saturday ‘the Sabbath’ (Ἡμερὰ τῷ σαββατῷ). But the Sun’s day is called the ‘Lord’s day’ (τῆς ἡμέρας τῆς κυριακῆς), and is the first day of the week. (I am using the Greek of Ms. *Monacensis* 70, as in Torijano, Appendix 2.)

TABLE 4.1 *Planetary days and hours*¹⁰⁹

Day	Presides	Manages Day Hours												
		1	2	3	4	5	6	7	8	9	10	11	12	
<i>Sunday</i>	⊙	⊙	♀	♂	♁	♃	♅	♁	♁	♁	♁	♁	♁	♁
<i>Monday</i>	♁	♁	♁	♁	♁	♁	♁	♁	♁	♁	♁	♁	♁	♁
<i>Tuesday</i>	♁	♁	♁	♁	♁	♁	♁	♁	♁	♁	♁	♁	♁	♁
<i>Wednesday</i>	♁	♁	♁	♁	♁	♁	♁	♁	♁	♁	♁	♁	♁	♁
<i>Thursday</i>	♁	♁	♁	♁	♁	♁	♁	♁	♁	♁	♁	♁	♁	♁
<i>Friday</i>	♁	♁	♁	♁	♁	♁	♁	♁	♁	♁	♁	♁	♁	♁
<i>Saturday</i>	♁	♁	♁	♁	♁	♁	♁	♁	♁	♁	♁	♁	♁	♁
Day	Presides	Manages Night Hours												
1	2	3	4	5	6	7	8	9	10	11	12	1	2	
(13)	(14)	(15)	(16)	(17)	(18)	(19)	(20)	(21)	(22)	(23)	(24)	(23)	(24)	
♁	♁	♁	♁	♁	♁	♁	♁	♁	♁	♁	♁	♁	♁	
♁	♁	♁	♁	♁	♁	♁	♁	♁	♁	♁	♁	♁	♁	
♁	♁	♁	♁	♁	♁	♁	♁	♁	♁	♁	♁	♁	♁	
♁	♁	♁	♁	♁	♁	♁	♁	♁	♁	♁	♁	♁	♁	
♁	♁	♁	♁	♁	♁	♁	♁	♁	♁	♁	♁	♁	♁	
♁	♁	♁	♁	♁	♁	♁	♁	♁	♁	♁	♁	♁	♁	

109 See Paulus, ch. 21; Olympiodorus, ch. 19, variant from β mss., on planetary days and hours (Boer, 37.1–22). Table created from Olympiodorus.

However, there is a vast difference between how the planets are treated here and in the *Testament of Solomon* (if they are planets there; this difference perhaps argues against that characterisation). In the *Testament*, they are only evil forces and, furthermore, subject to Solomon's control. In the *Hygromanteia*, planets are invoked for both good and ill as masters of the days and the hours, and the diviner must use their astrological powers. Each planetary hour has been assigned both an angel and a demon, and good deeds or bad are sought accordingly. The list of angels and demons precedes prayers to God and to the planet (treated almost as a god), using characteristics associated with that planet. As Torijano indicates, these prayers seem adaptations of pagan ones with a monotheistic gloss at the beginning.¹¹⁰ He also mentions the obvious similarities in style with Hermetic texts.¹¹¹ The prayers are not unlike those to the planets in the *Picatrix*.¹¹² Finally, the metals, stones and plants of each planet are given, again mostly standard astrological designations.¹¹³ The *Hygromanteia* of Solomon is pagan at heart in its presentation, and shows its dependence on pagan astrological sources. It must have been a way for Jewish magicians and astrologers to adapt the time-honoured tradition of astrological magic to an acceptable Jewish framework.

1.5 *Christian Demons*

Christian demonology in general continued the tenets of later Jewish demonology: that demons were purely evil, caused men to become evil and to sin,

110 Torijano, *Solomon the Esoteric King*, 168. See an example in Appendix 4.A.

111 Ibid., 151 and nn. 27 and 28, citing respectively Heeg, in *CCAG VIII/2*, 140; and R. Reitzenstein, *Poimandres: Studien zur griechisch-ägyptischen und frühchristlichen Literatur* (Leipzig: Teubner, 1904), 187, n. 1.

112 See e.g., Liber III, 7.16–33 (D. Pingree, *Picatrix: The Latin Version of the Ghāyat al-ḥakīm* (London: Warburg Institute, 1986), 118.7–135.15).

113 E.g. Saturn is associated with lead, Venus with lapis, the Sun with gold. For more on astrological metals and stones, see PGM CX, 1–12 and the description of the astrological markers in Pseudo-Callisthenes, *Historia Alexandri Magni*, I, 4.6 (Kroll, 5). Also J. Evans, 'The Astrologer's Apparatus: A Picture of Professional Practice in Greco-Roman Egypt', *JHA* 35 (2004): 1–44, esp. 4–5, 14–17; and Z. M. Packman, 'Instructions for the Use of Planet Markers on a Horoscope Board', *ZPE* 74 (1988): 85–95. For astrological botany, see Thessalus of Tralles, *De virtutibus herbarum*, in *Thessalos von Tralles*, ed. Hans-Veit Friedrich (Meisenheim am Glan: Hain, 1968); F. Cumont, 'Écrits hermétiques', II: *Le médecin Thessalus et les plantes astrales d'Hermès Trismégiste*, *RPh* 42 (1918): 85–108; and C.-E. Ruelle, 'Le Livre Sacré sur les Décans', *RPh* 32, no. 4 (1908): 247–77.

and could possess men.¹¹⁴ They caused both physical and mental illness, but increasingly there was an emphasis on moral imperatives and the battle of good *versus* evil. Demons were not just physically or mentally bad, they were morally evil and could not be rehabilitated or propitiated, only destroyed or banished. There was no compromise with any view, such as that of Hellenised pagans, that daimons could be benefic. Although the Jews began the concept of angels as messengers of God who were mostly good (bad angels were the ‘fallen’ ones of, e.g., the *Book of the Watchers*), and set up hierarchies of angels, the Christians developed these to a high degree, and emphasised their opposition to what seemed to be leagues of demons.

As in the Septuagint, *daimonion* is the preferred word for evil daimon in the New Testament.¹¹⁵ The word δαίμων appears only three times, in Matthew 8:31, Mark 5:12 and Luke 8:29.¹¹⁶ Of the fifty-five times that *daimonion* appears in the NT, forty-six are references to demonic possession or exorcism,¹¹⁷ showing the importance of this concept to the Christians. Jesus is seen as the master of exorcisms; one could even say that a valuable facet of his appeal is his ability to cast out demons. Thus both Jesus and the demons acquire an importance as adversaries of each other.¹¹⁸

Equally important was the heightening of the battle between good and evil. Demonic possession developed into a moral evil (in contrast to the Mesopotamian version of an attack by a demon of neutral moral force), and exorcism from a ritual of substitution and appeasement of the divine (in Mesopotamia) to an absolute renunciation of morally evil demonic power. Jesus is not just expelling demons, he is claiming souls for God against Satan. Samson Eitrem expresses it well: ‘Jesus’ bifurcation of the whole world-order—and its eschatologic counterpart—into Heaven and Hell, into angels and demons, his radical “Yes” and “No”... came out spontaneously in a

114 For studies of demons and demonology in the New Testament, see the bibliography in Sorensen, *Possession and Exorcism*, 120, n. 5.

115 *DDD*, 239, col. 1. The one use where this is not so, Acts 17:18, is an indirect quotation of Greek philosophers who call Paul’s religion ‘of foreign *daimonia*’; as a Greek characterisation it does not represent the Christian position of daimons as evil.

116 *Ibid.*, 239, col. 1, claims it appears only once, in Matthew, but I found the other two references.

117 The references to possession occur in the gospels, not the other books of the NT. I am not including the numerous references to evil ‘spirits’ (*pneumata*) or verbs like ‘be demonised’, i.e., possessed, but these would equally apply to demons. See a full list of references to possession by and exorcism of demons/spirits/the devil, etc. in Sorensen, *Possession and Exorcism*, 121–22 and nn. 7–19.

118 For more on the prominence of both exorcist and demon, see *ibid.*, 125 and n. 52.

monotheistic victory over the demons and their would-be autocratic prince.¹¹⁹ This extreme and increasingly strident dualism sets the course for later Christian writings on demons, and has an impact on the way astrology was viewed in them.¹²⁰

The association of demons with illness is honed to a high gloss in the *New Testament*. The possessed are afflicted with both physical and mental ailments, including emotional outbursts, neurotic behaviour and the outright madness we would call psychosis today.¹²¹ But the violent death associated with earlier Jewish demons (also seen in Mesopotamian, Egyptian and Greek cultures) is absent in the *New Testament*. People are possessed by demons, but they do not die, just suffer miserably. And, of course, no exorcism by Jesus ever fails or ends with the death of the victim.

Jesus's exorcistic practices did not go unremarked by pagan magic practitioners. His name shows up in several Greek Magical Papyri as effective in banishing or summoning daimons.¹²² He thus gained fame as a magician in the pagan world. The practitioners using the Greek Magical Papyri were not so much interested in exorcism as a tool for healing the sick as they were in finding a technique that worked for controlling daimons, and Jesus's success in this made invoking his name a valuable tool.¹²³ Eitrem makes a case study of PGM IV.3007–3086 as an example of the use of Jesus's name in a major spell.¹²⁴ Interestingly, the word used for demons in this spell is 'daimonion', not 'daimon'.¹²⁵

The Egyptian alchemist Zosimus of Panopolis (fl. ca. 300 CE) was also influenced by the Jewish and Christian view of daimons as evil. It is not clear whether

119 S. Eitrem, 'Some Notes on the Demonology in the New Testament', *Symbolae Osloenses* Fasc. Supplet. XII (1950): 1–60, here 4.

120 I am preparing an article for publication on the Christian demonisation of the daimon and connections to astrology.

121 Sorensen, *Possession and Exorcism*, 124–25, gives the NT citations of these. Eitrem, 'Notes on Demonology', 28–29, points out, in addition to the casting out of demons from the sick, Jesus's power to cure disease without demonic presence; sometimes there is a mixture of the two. Sorensen, 135–36, deals with this too.

122 Sorensen, *Possession and Exorcism*, 178 and n. 23, gives a list of the papyri.

123 *Ibid.*, 180–82.

124 Eitrem, 'Notes on Demonology', 9–18; some of his analysis is now outdated. See the same passage in Betz, ed., *GMP*, 96–97, and the bibliography esp. at n. 388.

125 M. Smith, 'The Demons of Magic' (paper presented at the Philadelphia Seminar on Christian Origins, Philadelphia, PA, 5 May 1988, online at <http://ccat.sas.upenn.edu/psco/year25/8805.shtml>), accessed 10 January 2015.

Zosimus adhered to any one religion,¹²⁶ but he was certainly a monotheist,¹²⁷ had read Jewish texts such as the *Book of the Watchers* (1 En. 1–36)¹²⁸ and definitely considered daimons to be wicked. He warns his fellow alchemical practitioner, Theosebeia, against them, saying that ‘the local demons flatter you, hungering not only for burnt-offerings, but also for your soul.’¹²⁹ In the *Final Receipt*, Zosimus uses the preferred Biblical word for demon, δαίμόνιον,¹³⁰ showing that he had absorbed this locution either from Biblical texts or from the common connotation of his culture. In any case, he mentions no good daimons.¹³¹ On the other hand, he is very willing to use astrological techniques, such as *katarchē*, in order to achieve his alchemical objectives, as long as he can separate them from the actions of demons.¹³² His repulsion of demons, based on his acceptance of texts like the *Book of Enoch*, forces him to find ways to accommodate his astrological alchemy to his beliefs about demons.

-
- 126 See B. Hallum, ‘Zosimus Arabus: The Reception of Zosimos of Panopolis in the Arabic/ Islamic World’ (Ph.D. Thesis, Warburg Institute, University of London, 2008), 21–25.
- 127 See Zosimus, *Epistle* 3.130–39, original Arabic with English translation in *ibid.*, 219–20.
- 128 Georgius Syncellus’s *Ecloga Chronographica* 24 (Mosshammer, 14.2–14; trans. Adler and Tuffin, 18–19) states this (cited by K. A. Fraser, ‘Zosimos of Panopolis and the Book of Enoch: Alchemy as Forbidden Knowledge’, *Aries* 4, no. 2 (2004): 125–47, here 125; and Hallum, ‘Zosimus Arabus’, 24). See also Hallum, ‘Zosimus Arabus’, 227 and n. 107. For Zosimus’ knowledge of another Jewish sage, Solomon, see Torijano, *Solomon the Esoteric King*, 178–83.
- 129 Zosimus, *Final Receipt* 7 (ἡ τελευταία ἀποχή), in A.-J. Festugière, *La révélation d’Hermès Trismégiste*, vol. 1. *Lastrologie et les sciences occultes* (Paris: Les Belles Lettres, 1950, repr. 1989, 2006), 367.7–8: . . . κολακεύουσιν σε τὰ κατὰ τόπον <δαίμονια>, πεινῶντα, οὐ μόνον θυσίας, ἀλλὰ καὶ τὴν σὴν ψυχὴν. (Cited in Hallum, ‘Zosimus Arabus’, 216.)
- 130 *Daimonia/daimonion* is extant in only one place in the text, in Festugière, *La rév.* 1, 367.15 (ms. A = Par. gr. 2327, 251v–255r) and 367.14 (ms. M = Marc. gr. 299, 171v–172r). Festugière has added δαίμων at 365.18, 366.9, 16, 27 and, following Reitzenstein, has supplied δαίμοσιν at 367.24.
- 131 In *On the Letter Omega*, 2.4 and 8 (Jackson, 18), he mentions the personal daimon (he uses *daimonion* in line 4 and *daimōn* in line 8); this too, unsurprisingly, is made malefic (unlike its usual Hellenistic conception).
- 132 Hallum, ‘Zosimus Arabus’, 215–16 and nn. 62–63, understands that Zosimus can separate ‘opportune tinctures’ (*καιρικαὶ βαφαί*) that are natural from ones that are demonic (the word *kairikos* is often used in setting up astrological *katarchai*). Fraser, ‘Alchemy as Forbidden Knowledge’, 137–44, points out the inherent conflicts Zosimus must try to reconcile, between the historical and strong links of astrology to alchemy, and the demonic perversions of the art, but he does not consider an astrological *katarchē* occurring in alchemy without the aid of demons.

2 The Places of Bad Daimon and Bad Fortune in Astrology

The above overview of bad daimons in different Mediterranean cultures has shown the various ways demons acted and were dealt with. In addition, we have seen the connotative change of the word *daimonion* from neutral to almost entirely pejorative. By detailing the association of demons with illness, violence and possession, we now have some context for the way that astrology treats demons via the sixth and twelfth places.

Naturally there is no hint in astrological writings that the practice of astrology is demonic. There are references to fate, even to daimons' involvement in fate, but the daimons so involved are not evil or malicious. The bad daimon's place in astrology revolves around what bad daimons are presumed to cause, e.g. illness, injury, violence and demonic possession.¹³³ Its literal place is the twelfth, the Bad Daimon place, and its counterpart, the place of Bad Fortune (the sixth).

2.1 *The Twelfth and Sixth Places*

Within the layout of the chart itself, the twelfth and sixth places are two of the four places called *apoklimata* ('declines'), i.e. falling from the angles. They are generally associated with the more unpleasant aspects of life, though there are 'good declines', the third and ninth, the places of the Sun God and Moon Goddess.

The sixth, Bad Fortune, and the twelfth, Bad Daimon, have no such positive associations, and mostly represent unpleasant things like slavery, enemies, sickness and injury. The tradition of pairing Fortune and Daimon continues here, again via their opposition. Their meanings are sometimes identical: as Valens says, 'Each place, then, will bring about its own particular outcomes according to what it means, but the nature of the opposite place will also cooperate.'¹³⁴

For Manilius, the twelfth is 'too much abounding in vice'.¹³⁵ Thrasyllus, quoting Hermes, calls the sixth 'daimonic [fortune]... indicative of penalty

133 Causes of demonic possession would be a concern of clients in this time period: see, e.g. Ptolemy, *Tetr.* III, 15.3, 5, 6; Hephaestio, II, 16.3, 5–6; Valens, I, 1.14; Dorotheus, V, 37.1–8. See other astrological references to bad daimons in F. Cumont, *L'Égypte des astrologues* (Brussels: La Fondation Égyptologique Reine Élisabeth, 1937), 167–70.

134 IV, 12.2 (Pingree, 170.18–19): "Ἐκαστος μὲν οὖν τόπος καθ' ὃ σημαίνει ἰδίως ἀποτελέσει, συνεργήσει δὲ καὶ ἢ τοῦ διαμετροῦντος τόπου φύσις.

135 *Astronomica* 2.866: '... vitio fecunda nimis...'

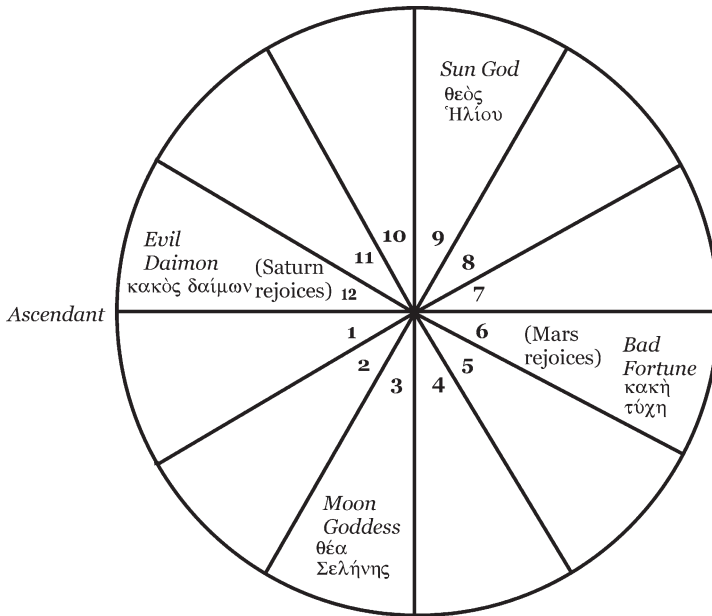
FIGURE 4.2 *Cadent places.*

and injury...'¹³⁶ The feminine adjective is also found in P. Mich.inv. 1, 149, col. ix.16 (δαίμωνιη) (These are the only such references to the sixth.) Both texts have Egyptian connections (that they both appear to use an adjective here may indicate a common source). The Demotic name for the sixth is *try.t hne*, 'lot of abomination'¹³⁷ and *ꜥ.wy wry*, 'house of bad fortune.'¹³⁸ *Wry.t* and *Špšy.t* (used of the fifth place: see Chapter Two, 2.2) are paired deities of bad and good fortune.¹³⁹ Perhaps the Egyptian feminine 'daimonic' deity of bad fortune has influenced the Greek descriptions.

136 CCAG VIII/3, 101.23–25: τὸ μέντοι ζ' δαίμ<ονι>αν καὶ ποινής καὶ σίνους δηλωτικόν.... I follow Hübner's suggestion (*Dodekatropos*, 54, citing Housman), re-emending δαίμ<ονι>αν (cod.) for Cumont's <κακο>δαίμονίας. The parallel construction with the fifth place (τὸ δὲ ε' ἀγαθὴν ἐκάλει τύχην, CCAG VIII/3, 101.22–23) suggests δαίμ<ονι>αν is a feminine adjective modifying an implied τύχην.

137 CDD, vol. H, s.v. *hne*, 104 (see Spiegelberg, 'Namen und Zeichen', 149.7; Neugebauer, 'Demotic Horoscopes', 16, Os. 3, l. 17).

138 P. Berlin 8345, 11/1, 1V/15. Hughes, 'Astrologer's Handbook', 56–57, 62, translates the house name as 'Evil Genius', but he does not consider the distinction between fortune and 'genius'. See his 'Demotic Plea', 179, where he even discusses the feminine pair of good and bad *fortune* deities, *Špst* and *Wry.t*, but still calls them 'Genius'.

139 See above note.

Malefics ‘rejoice’ in these places, Saturn in the twelfth and Mars in the sixth.¹⁴⁰ The sixth, says Firmicus, is called Bad Fortune precisely because it is Mars’s place (II, 19.7). The day planet, Saturn, rejoices above the horizon in the twelfth, while the night planet, Mars, rejoices below the horizon in the sixth.

There are correlations here with philosophical bad daimons as described by Porphyry:

But the souls which do not control the *pneuma* adjacent to them, but are mostly controlled by it, are for that very reason too much carried away, when the angers and appetites of the *pneuma* lead to impulse. These souls are also daimons, but may reasonably be called evil-working. . . . Their character is wholly violent and deceptive and lacking the supervision of the better daimonic power. . . .¹⁴¹

Like bad daimons, malefics are considered so because of their urge toward excess (Porphyry’s ‘too much carried away’). Being excessively affected by the passions leads to things like violence and debauchery signified by planets, especially malefics, falling in the twelfth or associated with the twelfth.

The twelfth and the sixth also, conveniently, provide geometrical reasons for being bad: they are *apostrophos* and *asundetos*, averse and unconnected, making no aspect to the Ascendant, a condition worse than being square or opposed, because no aspect means no possibility of relationship to the Ascendant, the representative of life itself. This may be one reason why the twelfth, in particular, represents childbirth, with all its attendant dangers and lack of controllability.¹⁴² When some sort of relationship exists, for which Ptolemy even uses the Stoic word *oikeiosis*,¹⁴³ there is an ability to work together based on kinship, familiarity or association. Without an aspectual relationship to the Ascendant, planets in the twelfth or sixth can act unrestrainedly, causing violent death, injury, perversions and mental illness.

140 See Paulus, ch. 24; Olympiodorus, ch. 23; Firmicus, II, 19.7, 13; Valens, II, 11. Hübner, ‘Divinités planétaires’, discusses the deities in the places.

141 *On Abstinence* II, 38.4 (Nauck, 167.26–168.5): ὅσαί δὲ ψυχαὶ τοῦ συνεχοῦς πνεύματος οὐ κρατοῦσιν, ἀλλ’ ὡς τὸ πολὺ καὶ κρατοῦνται, δι’ αὐτὸ τοῦτο ἀγονταὶ τε καὶ φέρονται λίαν, ὅταν αἱ τοῦ πνεύματος ὄργαι τε καὶ ἐπιθυμίαι τὴν ὀρμὴν λάβωσιν. αὐταὶ δ’ αἱ ψυχαὶ δαίμονες μὲν καὶ αὐταὶ, κακοεργοὶ δ’ ἂν εἰκότως λέγοιντο.; 39.3 (Nauck, 168.20–22): βίαιον γὰρ ἔλως καὶ ὑπουλον ἔχοντες ἦθος ἐστερημένον τε τῆς φυλακῆς τῆς ἀπὸ τοῦ κρείττονος δαιμονίου. . . . (Trans. Clark, *On Abstinence*, 71, slightly modified.)

142 See below, ‘Birth and the Twelfth Place’.

143 E.g., I, 12, 14, 17, 19.

TABLE 4.2 *Names and descriptions of the sixth and twelfth places*

Astrologer	Name of Sixth	Description	Name of Twelfth	Description
Manilius (<i>Astronomica</i> , 2.864–870)	None given	Cast down Gate of toil	Unhappy region	Hostile to future; Abounding in vice; Gate of toil; Cast down
Dorotheus (I, 5-5; p. 396.28–397.1; 397.100–11)	Bad Fortune Accursed Fortune	Worst of the worst Exile	Bad Daimon Accursed Daimon	Worst of the worst Exile
Thrasyllus/ Hermes Thrasyllus/ Nechepso- Petosiris (<i>CCAG</i> VIII/3,100)	Daimonic (H) Bad Fortune (N-P)	Penalty and injury	Bad Daimon (both)	Manner of living Slaves
P. Mich.inv. 1, 149 (Col. ix.1–25)	Daimonie	Injury Illness	[Bad Daimon]	None given
Antiochus (<i>CCAG</i> VIII/3, 117; <i>CCAG</i> VII, 114)	Daimon Pre-setting	Hardships; Illnesses; Enemies; Dog-men	Decline Daimon Necessity	Conception; Hardships; Illness; Epileptics; Dog-men
Vettius Valens (II, 5.1–3; II, 11.1–2; II, 16; IV, 11.48; IV, 12.1; IX, 3.6–18)	Bad Fortune	Vagabond; Slander; Exile; Slaves; Injury; Enemies; Illness; Weakness; Accusation	Bad Daimon	Injuries; Falls; No fortune; Beggars; Lacking nourish- ment; Illness; Foreign coun- tries; Enemies; Slaves; Dangers; Weakness; Judgements

TABLE 4.2 *Names and descriptions of the sixth and twelfth places (cont.)*

Astrologer	Name of Sixth	Description	Name of Twelfth	Description
Manetho (I.134–135; IV.593–596; VI.19, 37, 61, 151, 216–221, 632–633)	Evil Destiny (Αἴσα κακή)	Mischief; Grudging of nurture; Numbing poverty	Bad Daimon	Exposure of infants; Nourished by strangers; Bad marriages
Firmicus Maternus (II, 14; II, 17; II, 19)	Bad Fortune	Health Sickness Inactive; cast down	Bad Daemon	Enemies; Slaves Infirmities; Sickness; Inactive; cast down
Paulus (Ch. 24)	Bad Fortune Penalty Pre- setting Base Decline	Injury; Female service and slaves; Enmities; Plots	Bad Daimon Pre-ascension	Oppressing enemies; Illnesses; Childbirth; Male slaves; Four- footed animals
Olympiodorus (Ch. 23)	Bad Fortune Base Decline	Inharmonious; Unconnected; Female service and slaves; Enmities; Injuries	Bad Daimon Pre-ascension	Illnesses; Childbirth; Enemies; Male slaves; Injuries; Four-footed animals
Hephaestio (I, 12; II, 10)	None given	The worst	Bad Daimon	Childbirth The worst
Liber Hermetis (36.32, 42, 45)*see n. 56	Part of Fortune?*	Perjurers; Thieves; Forgers; Become dogs; Eaten by dogs	Part of Daemon?*	Violent death; Perjurers; Thieves; Forgers; Become dogs; Eaten by dogs

Astrologer	Name of Sixth	Description	Name of Twelfth	Description
Rhetorius (Ch. 57: <i>CCAG</i> VIII/4, 126–31, 154–157)	Bad Fortune Pre-setting Pre-descension Base Decline <i>Metakosmios</i>	Injury; Slaves; Enemies; Four- footed animals; Foreign or low- born parents; madmen; epileptics	Bad Daimon <i>Metakosmios</i>	Enemies; Slaves; Four-footed animals; Childbirth; Illnesses and wounds; Banishment; Devoured by dogs; mad-men; Dog-men

Rhetorius gives further insight on the cadent places: he calls them *metakosmios*, between worlds.¹⁴⁴ He recognises that these places are all transitions between different temporal and spatial conditions: between day and night, rising and setting, darkness and light. They are in the liminal space beloved by the Greeks as a place where prophetic dreams and divine contact can occur.¹⁴⁵ But these states can be not only enrapturing but terrifying. The third and ninth places represent the (mostly) positive side of this numinosity, while the sixth and twelfth are its dark underbelly, in which the fears and terrors of psychical life are given physical reality in slavery, enemies, hunger, exile, sickness, injuries and childbirth. This is why Dorotheus calls these places ‘the worst of the worst’.¹⁴⁶

144 *CCAG* VIII/4, 126.16–17: ‘Ο δωδέκατος τόπος καλεῖται κακοδαιμόνημα καὶ προαναφορὰ τοῦ ὠροσκόπου καὶ μετακόσμιος. ‘The Twelfth Place is called “Evil Daimon”, and pre-ascension of the Hour-marker and between worlds.’ (Sim. for other cadent places at *CCAG* VIII/4, 144.17, 154.19, 163.20.) Cumont’s note 1, p. 163 says ‘The places of the Moon and Sun are called *μετακόσμιος* because these stars receive the souls exiting from this world.’

145 See D. G. Greenbaum, ‘Rising to the Occasion: Appearance, Emergence, Light and Divination in Hellenistic Astrology’, in *The Imaginal Cosmos: Astrology, Divination and the Sacred*, ed. Angela Voss and Jean Hinson Lall (Canterbury, Kent: University of Kent, School of European Culture and Languages, 2007), 9–24, esp. 21.

146 I, 5.5 (Pingree, 164): ‘There remain equal to this two places which are the worst of the worst, and they are the sixth and the twelfth.’ Cf. Hephaestio, I, 12.1 (Pingree, 39.13–14): οἱ τε λοιποὶ δύο ὃ τε ἕκτος καὶ <ὁ> δωδέκατος κάκιστοι. (= Dorotheus, Pingree, 325.23–24).

The twelfth and sixth, because they represent this link to something that is divine but unknowable and mysterious, over which there is no control, may be a prime example of the unchangeable parts of a necessary fate given in the chart. The negative events they represent often lead to despair and the inability, because of that hopelessness, to see any way out from those unfortunate states.¹⁴⁷

2.2 *Planets in the Sixth and Twelfth*

The effects of the twelfth and sixth places are judged by planets (or other points) in them or ruling them, and the sign rulers of the places. Most delineations involving the sixth or twelfth are unrelievedly negative.¹⁴⁸ But sometimes sect can mitigate the circumstances (as in the case of the Good Daimon and Fortune places). Rhetorius says: ‘When Ares happens to be in the Bad Daimon zodiac signs <in the twelfth>,¹⁴⁹ he becomes responsible for illness and injuries, but also in dangers and not a few plots of slaves or the condemned and imprisoned, especially by day; by night the evil will be moderated.¹⁵⁰ (Other delineations from Rhetorius give unfortunate outcomes no matter what the planet or its sect is.) Olympiodorus, though, makes clear that planets in sect can provide good outcomes:

If Ares is found in this place [*the sixth*] according to sect, trined by benefic stars or even with Aphrodite in a feminine sign, it leads to military glory and advancement. But [even] if it is not figured by a benefic star, it will not thus bring on great evils, if it is not contrary to sect. In the same way nor will Kronos when according to sect, since the bad rejoice in bad places.¹⁵¹

147 This is another contrast between adjacent places in the ‘hope’ assigned to the eleventh place and conditions leading to hopelessness in the twelfth.

148 See e.g. Dorotheus IV, 1; Valens, II, 5 and II; Paulus, 24, Manetho, VI, Rhetorius 57.

149 Added in Pingree’s critical edition, in preparation by Stephan Heilen: Rhetorius, *Compendium*.

150 *CCAG VIII/4*, 130.5–8: ‘Ἐν δὲ τοῖς κακοδαιμονούσι ζωδίοις ὁ Ἄρης <ἐν τῷ δωδεκάτῳ> παθῶν καὶ σινῶν παραίτιος γίνεται. γίνονται δὲ καὶ ἐν κινδύνοις καὶ ἐπιβουλαῖς οὐκ ὀλίγαις ἕνεκα δουλικῶν ἢ κατακρίτων καὶ συνεχομένων προσώπων, μάλιστα δὲ ἡμέρας. νυκτὸς δὲ μετριώτερα τὰ κακὰ γίνονται.

151 Ch. 23 (Boer, 67.14–21): Εἰ δὲ ὁ Ἄρης εὐρεθῆ ἐν τούτῳ τῷ τόπῳ κατὰ αἵρεσιν τριγωνιζόμενος ὑπὸ ἀγαθοποιῶν ἀστέρων ἢ καὶ σὺν τῇ Ἀφροδίτῃ ὧν ἐνταῦθα ἐν θηλυκῷ ζωδίῳ, ἐπὶ στρατιωτικὴν δόξαν καὶ προκοπὴν ἄγει. εἰ δὲ μὴ σχηματίζεται ὑπὸ ἀγαθοποιῶν ἀστέρων, οὐδὲ οὕτως μεγάλα κακὰ ἐπάξει, ἐὰν μὴ ἢ παρ’ αἵρεσιν· ὡσαύτως δὲ οὐδὲ ὁ Κρόνος κατὰ αἵρεσιν ἐκεῖσε ὑπάρχων, ἐπειδὴ χαίρουσιν οἱ κακοὶ ἐν τοῖς κακοῖς τόποις.

Firmicus takes sect especially seriously; it qualifies a number of his delineations in Book III. For instance:

Mercury and Saturn set by degree in the 6th and the 12th place from the Hour-marker decree the same things by similar reasoning. For if they are found in these places by day, they will produce people who know about many areas of knowledge, who are competent in the knowledge of occult arts, and who wish to know all things which have to do with human affairs; who are very malicious and envious, and who are intimately connected with vices or infirmities. By night, Saturn and Mercury set in the 6th and 12th place of the nativity produce forgers, malicious scoundrels, malevolent poisoners, but who are always intimately connected with the greatest evils and the greatest compulsions.¹⁵²

Since Saturn is a day planet and the twelfth is above the horizon, it confers better things in a day chart. But Saturn below the horizon at night is truly malevolent and produces no good at all.¹⁵³

For Ptolemy, the Bad Daimon place ‘afflicts the effluence flowing onto the earth from the stars in it, while also declining, and it also muddies just as the thick and misty vapour from the moisture of the earth obscures, by which the stars do not appear naturally in either their right colours or magnitudes.’¹⁵⁴

Generally, then, anything to do with the sixth or twelfth places is tainted by their malignity. So when luminaries are there, they produce low-born, slave or

152 III, 9.6 (KSZ, I, 169.6–17 = Monat, II, 99): In sexto [loco] et in XII ab horoscopo loco partiliter constituti Mercurius et Saturnus eadem simili ratione decernunt. Si enim per diem in his locis fuerint inventi, multarum doctrinarum scios facient, absconsarum artium doctrina pollentes, et qui omnia, quae in rebus humanis sunt, velint scire, malitiosos sane et invidos et qui vitiis aut valitudinibus implicentur. Per noctem vero in VI et in XII geniturae loco Saturnus et Mercurius constituti falsarum litterarum auctores, sceleratos malitiosos malivolos veneficos facient, sed qui semper maximis malis et maximis necessitatibus implicantur.

153 Firmicus is careful with his word order here: the day chart has ‘Mercury and Saturn . . . in the 6th and 12th’, implying Mercury in the 6th and Saturn in the 12th. Saturn is above the horizon in a day chart, and is a diurnal planet. At night, Saturn is in the 6th and Mercury in the 12th, so the diurnal planet is below the horizon in a night chart, making it doubly bad.

154 *Tetr.* III, 11.4 (Hübner, 205.580–584): . . . κακοί τὴν ἐπὶ τὴν γῆν ἀπόρροϊαν τῶν ἐν αὐτῷ ἀστέρων μετὰ τοῦ καὶ ἀποκεκλικέναι, θολοὶ καὶ ὡσπερ ἀφανίζει τὸ ἀναθυμιώμενον ἐκ τῶν τῆς γῆς ὑγρῶν παχὺ καὶ ἀγλυῶδες, παρ’ ὃ καὶ τοῖς χρώμασι καὶ τοῖς μεγέθεσιν οὐ κατὰ φύσιν ἔχοντες φαίνονται.

outcast fathers or mothers (the Sun and Moon represent, respectively, father and mother). Thus the Sun in the twelfth ‘produces those unable to bear children, slaves or captives; some also are tried by injuries or illnesses.’¹⁵⁵ Benefics there cannot mitigate the sixth’s and twelfth’s unfortunate effects either, as Rhetorius writes:

When Aphrodite happens to be in the Bad Daimon zodiac sign by night, <she makes> those distressed through the allegations of women. If she is balefully aspected by Kronos and Hermes or <Ares>, <she makes> also those involved in soul-sicknesses—that is, amorous ones. But some are joined to female slaves or courtesans, and because of that they become childless.¹⁵⁶ By day when she is in this place, she signifies those who die badly and violently on account of women [and how they die is] according to the particular nature of the zodiac signs. . . .¹⁵⁷

The bad effects are tailored to Aphrodite’s particular significations. Like the eleventh place, which can blunt the negativity of malefics by its *goodness*, the power of the twelfth is such that its *badness* can blunt the goodness of benefics.

As might be expected, the twelfth and sixth can also show mental illness, epilepsy and even possession. However, they are not the prime candidates for these maladies; more often the Sun or Moon, or the Lots of Fortune or Daimon (which are formed using the positions of the Sun and Moon), in combination with malefics, produce these conditions. Perhaps this is because Sun and Moon are representatives of body, soul and spirit. Thus Antiochus says:

. . . and likewise for the nocturnal hours, if the lord of the hours of the one managing should be in the [place] of the Bad Daimon, it makes those devoured by wild beasts. But if Kronos should manage when the Moon is opposing, it makes epileptics and those possessed by gods.¹⁵⁸

155 Rhetorius, *CCAG VIII/4*, 130.11–13: . . . ἀγενεστέρους τοὺς γονεῖς ἢ δούλους ἢ αἰχμαλώτους ποιεῖ. τινές δὲ καὶ σινῶν ἢ παθῶν πειρῶνται.

156 These first three sentences are almost *verbatim* from Paulus. See ch. 24 (Boer, 72.4–8). (Rhetorius was a compiler, after all.)

157 *CCAG VIII/4*, 130.14–20: Ἐπὶ δὲ τῷ κακοδαιμονοῦντι ζῳδίῳ τυχοῦσα ἢ Ἀφροδίτη νυκτὸς διὰ γυναικῶν προφάσεις λυπούμενους <ποιεῖ>. ἐὰν δὲ κατοπτεύηται ὑπὸ Κρόνου καὶ Ἑρμοῦ ἢ Ἄρεως καὶ πάθει ψυχικοῖς περικυλισμένους τουτέστιν ἔρωτικοῖς· τινές δὲ καὶ δούλαις ἢ ἑταίραις ζεύγνυνται, ὧν χάριν καὶ ἐν ἀτεκνία γίνονται. ἡμέρας δὲ τυχοῦσα ἐπὶ τοῦδε τοῦ τόπου κακῶς καὶ βιαίως ἕνεκα γυναικῶν ἀπολλυμένους σημαίνει κατὰ τὴν τῶν ζῳδίων φυσικὴν ιδιότητα. . . .

158 *CCAG VII*, 114.29–32: . . . ὁμοίως καὶ ἐπὶ τῶν νυκτερινῶν ὥρῶν, ἐὰν ὁ κύριος τῶν ὥρῶν τοῦ διέποντος κακοδαιμονήσῃ, θηριοβρώτους ποιεῖ· ἐὰν δὲ ὁ Κρόνος διέπῃ Σελήνης διαμετρούσης, ἐπιλεπτικούς καὶ θεοφορούμενους ποιεῖ. For planets managing hours, see Table 4.1.

Rhetorius adds: 'If the Sun and Moon happen to be in this place [*the twelfth*], when malefics are on a centrepin, with a benefic not regarding them, they make the natives think they are dogs.'¹⁵⁹ And also: 'When the Sun and Moon are concurrent there [*in the sixth*], [they make] madmen, epileptics, the deranged.'¹⁶⁰ And Ares in the fourth at night can make 'maniacs and epileptics, if he is the house-master of the Lot of Fortune, the Hour-marker or the Lot of Daimon.'¹⁶¹

Some case studies will further illuminate the workings of daimonic places.

2.3 *The Poetry of the Bad Places in Manilius*

That which is above the rising place, third from highest heaven
 Is an unhappy region, hostile to the future
 And too much abounding in vice; it is not alone, but
 Equal to it will be that seat which shines with opposing constellation,
 Joined beneath the setting place. And not to be outdone
 Each one, with ruin before its eyes, cast down,
 Is carried from a cardine of the world.
 Each will be a gate of toil: one must climb, the other fall.¹⁶²

With breathtaking economy, in a mere seven lines, Manilius manages to locate the twelfth and sixth spatially, especially in relation to the Ascendant and Descendant; explain what the twelfth represents; and contrast the twelfth with the eleventh while comparing it with the sixth. There is some marvellous wordplay in this passage. The first line emphasises the height—'super' and 'summo'—from which the fall will come. The second gives us the unfortunate outcomes of the twelfth: 'infelix' and 'inimica' (both lines show clever alliteration). The 'infelix regio' clearly contrasts the twelfth with the 'felix' eleventh: there are no friends here, nor hopes for the future—only enemies and misery

159 CCAG VIII/4, 127.21–23: ἐὰν δὲ ὁ Ἥλιος καὶ ἡ Σελήνη ἐν τούτῳ τῷ τόπῳ τύχωσιν τῶν κακοποιῶν ἐπικέντρων ὄντων ἀγαθοποιῶν μὴ ἐπιθεωροῦντος, κυνανθρώπους ποιοῦσιν τοὺς γεννηθέντας . . . LSJ, s.v., glosses κυνανθρώπος as 'a malady in which a man imagines himself to be a dog'. Almost identical sentences occur in Antiochus, CCAG VII, 114.38–115.2; and the *Liber Hermetis*, 36.45.

160 CCAG VIII/4, 155.21–22: Ἥλιος δὲ καὶ Σελήνη συνοδεύοντες ἐκεῖ μανικούς, ἐπιλήπτους, φρενοβλαβεῖς.

161 CCAG VIII/4, 151.12–13: . . . μανιώδεις καὶ ἐπιλήπτους, ἐάνπερ οἰκοδεσποτήσῃ τοῦ κλήρου τῆς τύχης ἢ τοῦ ὠροσκόπου ἢ τοῦ δαίμονος.

162 *Astronomica*, 2.864–870 (Goold): 'quae super exortum est a summo tertia caelo, / infelix regio rebusque inimica futuris / et vitio fecunda nimis; nec sola, sed illi / par erit, adverso quae fulget sidere sedes / iuncta sub occasu. neu praestet, cardine mundi / utraque praetenta fertur deiecta ruina. / porta laboris erit: scandendum est atque cadendum.'

lie ahead.¹⁶³ Though Manilius never calls this place ‘daemon’, the phrase ‘too much abounding in vice’ surely refers to the evil daimon who tempts humans to yield to their passions and worst impulses (as in the Posidonius quotation earlier). In a neat twist, Manilius reveals the similarity of opposites and the dissimilarity of neighbours: the eleventh, though adjacent, is really the twelfth’s opposite, while the sixth, though opposite, is its soulmate. Finally, falling is stressed in the last three lines by putting it in tandem with rising-type words: ‘sub occasu . . . praestet’, ‘praetenta . . . deiecta’, ‘scandendum . . . cadendum’. In this way Manilius emphasises the rhythm and symbiosis of rising and falling, for one would not happen without the other.¹⁶⁴

2.4 *Birth and the Twelfth Place*

A number of astrologers connect the twelfth place with childbirth,¹⁶⁵ especially with the dangers of labour and delivery. In determining the vitality of an infant, for instance, Manetho watches for malefics afflicting the Moon. When he sees the Moon in the Ascendant besieged by Saturn in the twelfth and Mars in the second (and benefics are not making aspects), ‘then they [*Saturn and Mars*], cutting the vital fetuses during the birth pangs, / draw them limb-by-limb from the belly.’¹⁶⁶

This is akin to what Hephaestio says about labour and delivery and the dangers of the twelfth:

Both Apollinarius and the Egyptians think it worthwhile to examine the zodiac sign rising before the Hour-marker, which they call Bad Daimon, and the post-ascension [of the Hour-marker] which they call life. For when the [*sc. malefic*] is in the [place] of the Bad Daimon at the hour [of birth], it happens that every danger occurs both for the one in childbirth and the one being born, with the foetus immediately falling into the opening of the uterus, and the joints of the pregnant woman being loosened, incurring danger of death equally for both of them. For the foetus, [this happens] through drowning, but for the woman in childbirth

163 Hübner, *Dodekatropos*, 35, thinks ‘infelix regio’ may even be a name, not a description, for the 12th (corresponding to *kakos daimon*), in tandem with the (*agathos daimon*) ‘felix regio’ of the 11th.

164 See *ibid.*, 41, Hübner’s discussion of the complementarity of rising and falling, with examples.

165 Manetho, VI.35–42; Paulus, ch. 24; Hephaestio, II, 10; Rhetorius, *CCAG* VIII/4, 126.15–127.5.

166 Manetho VI.41–42 (Lopilato, 114): . . . τότε ἐπ’ ὠδίνεσσι βρέφη θρεφθέντ’ ὀλοῆσιν / νηδύος ἐξέλκουσι διαμελείσσι ταμόντες. (Trans. Lopilato, 278.)

through relaxing the openings of the natural female anatomy beyond what is right. And again, after the birth, if malefics are found in the [place] of 'Life' and will subsequently take the place of the Moon or the Sun, they will destroy the life and make it of short duration.¹⁶⁷

This graphic description brings home the dangers of giving birth in antiquity, and reminds us why Rhetorius calls the twelfth *metakosmios*. It is the place 'of Kronos, because through the outpouring of waters the fetus is expelled'¹⁶⁸ and because the mother comes into a state between life and death when the Moon is regarded by Kronos and Ares by opposition.¹⁶⁹ Rhetorius also explains why the first place is called 'life': 'It is so-called because of this: since after the emergence of the Bad Daimon, this zodiac sign emerges and, after the passage of the crisis of life, the one giving birth, and the foetus, appear, and because both have come from danger and darkness into light and life.'¹⁷⁰ Cumont suggests that even the first place has an ambivalent quality because it is below the horizon, and thus still in the territory of death: '... the first place is of the hemisphere of death.'¹⁷¹

167 Π, 10.14–16 (Pingree, 110.28–111.9): Καὶ Ἀπολλινάριός τε καὶ οἱ Αἰγύπτιοι ἀξιοῦσι σκοπεῖν καὶ τὸ προανηγμενὸν ζῳδίων τοῦ ὠροσκοποῦ, ὃ καὶ κακοδαιμόνημα προσαγορεύουσιν, καὶ τὸ ἐπαναφερόμενον, ὃ καὶ βίον καλοῦσιν. τοῦ γὰρ [sc. κακοποιοῦ] κακοδαιμονήσαντος ὄντος ἐπὶ τῆς ὥρας πάντα τὸν κίνδυνον συμβαίνει γίνεσθαι τῇ τε τικτούσῃ καὶ τῷ γεννωμένῳ, τοῦ βρέφους εἰς τὸ στόμιον ἤδη τῆς ὑστέρας ἐμπίπτοντος καὶ τῶν ἀρμῶν τῆς κυοφορούσης λυομένων ἀμφοτέροις κίνδυνον ἰσοθάνατον ὑπάρχειν, τῷ μὲν βρέφει διὰ τὸ συμπνίγεσθαι, τῇ δὲ τικτούσῃ διὰ τὸ τοῦς πόρους τῆς γυναικείας φύσεως ὑπὲρ τὸ δέον χαλᾶσθαι. καὶ πάλιν δὲ μετὰ τὸ γεννηθῆναι ἐὰν κακοποιοὶ εὐρεθῶσιν ἐν τῷ βίῳ καὶ διαδέξωνται τὴν Σελήνην ἢ τὸν Ἥλιον, ἀφανίζουσι τὴν ζωὴν καὶ ὀλιγοχρόνιον ποιοῦσιν.

168 I.e., the release of amniotic fluid. Kronos is often associated with occupations having to do with water; cf. Paulus (Boer, 65.9–19), Olympiodorus (Boer, 71.19–22).

169 Rhetorius, *CCAG VIII/4*, 127.2–5: Κρόνου... καθὸ διὰ τῆς προχοῆς τῶν ὑδάτων ἐκκρίνεται τὸ βρέφος καὶ ὅτι μέσον ζωῆς καὶ θανάτου ἡ τίκτουσα καθέστηκε ὑπὸ Κρόνου καὶ Ἄρεως κατὰ διάμετρον ἐπιθεωρουμένη.

170 *CCAG VIII/4*, 131.17–132.2: ... διὰ δὲ τοῦτο οὕτως ἐκλήθη ἐπειδὴ μετὰ τὴν τοῦ κακοδαιμονήματος ἀνατολὴν τοῦτο τὸ ζῳδίων ἀνατέλλει καὶ μετὰ τὴν τοῦ κλιμακτῆρος πάροdon περὶ ζωῆς ἐξετάζεται καὶ ἡ τίκτουσα καὶ τὸ βρέφος, καὶ ὅτι ἀμφότεροι ἀπὸ κινδύνων καὶ σκότους ἐπὶ τὸ φῶς ἐληλύθησαν καὶ τὴν ζωὴν....

171 *CCAG VIII/4*, 154, n. 1.

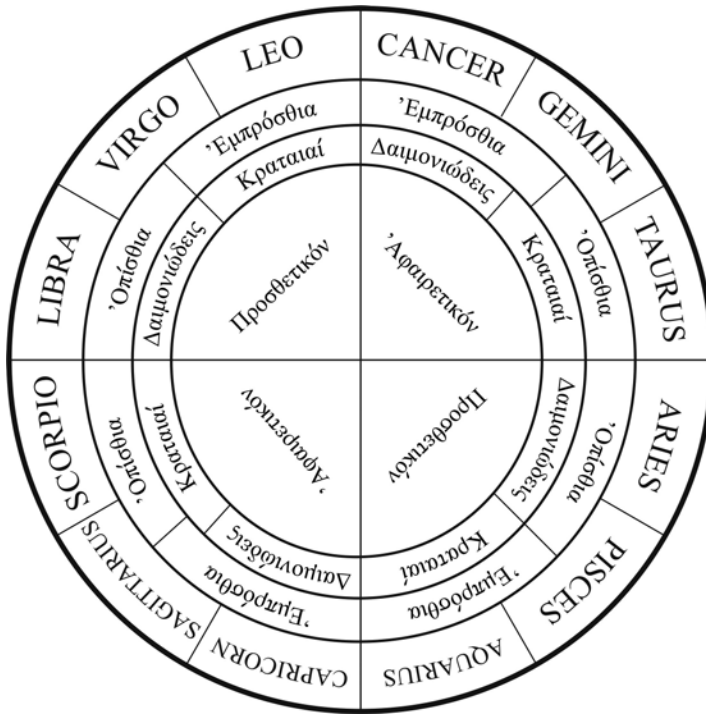

FIGURE 4.3 *The Sign Melothesia in P. Mich, inv. 1, 149.*¹⁷²

2.5 *Michigan Papyrus inv.1, 149—Strong or Daimonic?*

P. Michigan inv.1, 149 was acquired by the University of Michigan in 1920–21, and examined by Frank Robbins in two articles: the first in 1927, and an expanded version in 1936 incorporating Housman's corrections.¹⁷³ Subsequent research on the papyrus has mostly focused on the astronomy of the papyrus

172 Robbins' illustration in Winter, ed., *Michigan Papyri*, 91, redrawn by the author and rotated 180°. I use the column numbers from this publication. With kind permission of the U. of Michigan Press.

173 F. E. Robbins, 'A New Astrological Treatise: Michigan Papyrus No. 1', *CPh* 22, no. 1 (1927): 1–45; F. E. Robbins, 'P. Michigan 149, Astrological Treatise', in *Papyri in the University of Michigan collection III: Miscellaneous Papyri*, vol. III, ed. J. G. Winter (Ann Arbor: University of Michigan, 1936), 62–117. Neugebauer and Van Hoesen call it 'one of the most interesting astrological papyri ever published' (O. Neugebauer and H. B. Van Hoesen, 'Astrological Papyri and Ostraca: Bibliographical Notes', *PAPhS* 108, no. 2 (1964): 57–72, here 60). Images, description and translation of the papyrus can be found at the University of Michigan's Advanced Papyrological Information System, http://www.lib.umich.edu/files/collections/papyrus/exhibits/MPC/Religion/Astrology_Frameset.html (accessed 18 March 2015).

(elongation from the Sun, planetary motion, rising times, etc.).¹⁷⁴ I have seen no commentaries on the very interesting way that the papyrus divides up the degrees of signs into κραταιαί and δαιμονιώδεις degrees. This system is unique in astrological writing, as far as I am aware.¹⁷⁵

The papyrus is dated palaeographically to the second century CE,¹⁷⁶ and contains, along with its astronomical information, a section on the 'octotopos' and a melothesia which weaves together a system of terms, 'front' and 'back parts' and 'strong' and 'daimonic' degrees. The melothesia and terms are based on planetary epicycles and motions, and are meant to present an 'image of man' (ἀνδρίας) correlated to the heavens.

The zodiac signs are divided into 'additive' (προσθετικόν) and 'subtractive' (ἀφαίρετικόν) quadrants, with three signs per quadrant; and each of the four quadrants are divided into 'front parts' (ἐμπρόσθια) and 'back parts' (ὀπίσθια) which are 'strong' or 'daimonic'. 'Additive' and 'subtractive' quadrants correspond to Paulus's masculine and feminine quadrants.¹⁷⁷ Each quadrant contains forty-eight degrees of frontparts and forty-two degrees of backparts, with forty-eight strong degrees and forty-two daimonic ones (these are synchronised in the additive quadrants, but not in the subtractive ones). There are complete planetary terms, including the Sun and Moon, for each set of frontparts and backparts; these correspond with the melothesia.

Let us look specifically at the strong and daimonic degrees. They follow zodiacal order (this is explained in col. vii.12–14). Each quadrant begins with strong degrees and ends with daimonic. The writer apparently begins with Leo (col. vii.7, 20), and I have rotated Robbins's drawing accordingly, putting the signs of the two luminaries at the top. Both consist only of 'front parts'. Leo, as the house of the Sun, fittingly consists of 'strong' degrees, while Cancer, the Moon's sign, is entirely daimonic. All the fixed signs (Leo, Scorpio, Aquarius, Taurus) are strong; all the cardinal signs (Cancer, Libra, Capricorn, Aries) daimonic. The mutable signs are mixed in both categories: strong/daimonic and front-/backparts. (The symmetry beloved of the Hellenistic mind is well in evidence here.)

What is the meaning of the strong and daimonic degrees? Serapion calls Saturn, Jupiter and Mars 'strong stars'.¹⁷⁸ There are 'strong leaders' in Porphyry's *Letter to Anebo*;¹⁷⁹ could they have something to do with the strong degrees?

174 E.g. HAMA, II, 831.

175 Unfortunately, space does not permit a complete analysis of the entire system.

176 Robbins, in Winter, ed., *Michigan Papyri*, 62; Robbins, 'Michigan Papyrus No. 1', 1.

177 Paulus, ch. 7 (Boer, 20.1–21.3).

178 CCAG VIII/4, 227.19: Κραταιοὶ ἀστέρεις λέγονται Κρόνος, Ζεὺς, Ἄρης.

179 *Letter to Anebo*, 2.12b (Sodano, 24.4): ... τοὺς λεγομένους κραταιοὺς ἡγεμόνας ...

In fact, there may be a decanic connection, as Porphyry mentions decans in the same sentence, and this may be a reason for the *daimoniōdeis* degrees being last; as we saw earlier (1.2, 121), the decans at the end of the year were considered particularly dangerous. The last degrees of signs are traditionally considered to be unfortunate by astrologers: for example, the last terms in the Egyptian and Ptolemaic systems are always allotted to either Mars or Saturn.¹⁸⁰ Even the last *place*, the twelfth, is the place of the Bad Daimon. In Hephaestio (quoting Critodemus), luminaries in the last degrees of a sign mean the child has no lifespan; this outcome also occurs if the last part of a sign marks the hour while malefics hold the first degrees.¹⁸¹

There is something a little dangerous about the daimonic degrees; the contrast with ‘strong’ degrees (a word implying authority at least) suggests something anti-authoritarian, even out of control, about them. All the degrees of the fixed signs, representing permanence, are strong; but those in the tropical and equinoctial signs, where seasonal change occurs, are daimonic. This accords with the Egyptian preference for stability (if indeed this system is originally Egyptian, adapted to a Hellenistic milieu).

Strong degrees are always on the right side, and daimonic degrees always on the left, of each quadrant. This preference for the right over the left is found in other instances in astrology. When Ptolemy outlines his reasons for choosing aphetic places in *Tetr.* III, 11.3, he chooses, besides the Ascendant, only places which make right-hand aspects to the Ascendant: the eleventh, tenth, ninth and seventh;¹⁸² and he also uses the words ‘power’ and ‘predomination’ (δύναμις and ἐπικράτησις) about them.¹⁸³ For Serapion, being in superior position always means being on the right; a planet in a tenth-place position to another planet (putting it to the right of that planet) is superior. In Paulus and Olympiodorus, crises are averted when contact occurs in a right-hand aspect.¹⁸⁴ A planet in a ninth-place position to another is also strong because it is to the right of the other planet. Even a planet in fewer degrees is superior to one having more degrees in the same sign because the former is to the right of the latter.¹⁸⁵ The same applies to aspects on the right. ‘In each nativity the tenth

180 See Table I.4 in Appendix I.A.

181 II, 10.42, 45 (Pingree, 114.22–23; 115.6–8).

182 He even refers to the ‘right sextile’, δεξιᾶς ἐξαγώνου, of the Good Daimon.

183 III, 11.3 (Hübner, 203.562–205.575).

184 Paulus, ch. 24 (Boer, 90.2–17); Olympiodorus, ch. 38 (Boer, 133.11–23).

185 Serapion’s example uses Mercury at Aries 10° and Saturn at 25°, so Mercury is to Saturn’s right. CCAG VIII/4, 227.1–5: . . . ὅταν δύο ἀστέρες ἐν τῷ αὐτῷ ζῳδίῳ τύχωσιν καὶ ὁ μὲν ἐλάσσονας μοίρας ἐπέχων τὸν τὰς πλείονας μοίρας ἔχοντα καθυπερτερεῖ. οἷον ἔστω τὸν τοῦ Ἑρμοῦ ἀστέρα

and ninth from the Moon, that is, the right square and triangle, is called a strong zodiac sign.¹⁸⁶ And ‘Tenth-place position is said to be the right-hand square.’¹⁸⁷

By contrast, our clues for the daimonic side’s significance are oblique and implied: thus ‘weak’ opposed to strong; ‘left’ opposed to right;¹⁸⁸ ‘last’ opposed to first. Serapion does not provide examples of ‘weak’ stars and weak aspects, nor does Ptolemy say that he is choosing the right-hand aspected places over left-hand ones because one is strong and the other weak; it may be understood, but he does not say it.

Ultimately, we can only speculate on the motivations for the strange arrangement in this papyrus (and admire its symmetry). It does not appear that any other astrologer ever followed this system, and it does not come into the Arabic tradition.

2.6 *Final Thoughts*

In practice, Hellenistic astrologers are not necessarily concerned with the motivations of bad daimons, only with the outcomes they produce and where these might be found in the chart. Certainly they were aware of connections between misery and bad daimons and, when the system of astrological places was created, places needed to be found to represent the unfortunate and unpleasant things in life. Culturally, it made sense for the Bad Fortune and Bad Daimon places to be paired, and to contrast them with the other cadent places of the (Sun) god and (Moon) goddess: both gods and daimons must be provided for.

When planets are delineated, they mostly cannot overcome the badness of the sixth and twelfth. The odd system of degrees in P. Mich.inv. 1, 149 incorporates the daimonic and links it to the body. As the place just preceding the Ascendant, the twelfth becomes bound with the perilous process of birth; as places in that grey, liminal space between light and dark (a space which can fill one with the presence of the divine, whether awesome or awful), the sixth and twelfth are places of uncertainty and danger, of things over which one has no control. For astrology, this is the dark side of the daimon.

εἶναι Κριῶν περὶ μοῖραν ἰ', τὸν δὲ τοῦ Κρόνου ἐν τῷ αὐτῷ ζῳδίῳ περὶ μοῖραν κε'. δῆλον ὅτι ὁ τοῦ Ἑρμοῦ τὸν τοῦ Κρόνου μοιρικῶς καθυπερτερεῖ.

186 *CCAG VIII/4*, 227.19–21: ζῳδίων κραταιὸν καλεῖται ἐκάστης γενέσεως τὸ δέκατον καὶ ἕνατον ἀπὸ Σελήνης, τουτέστι τὸ δεξιὸν τετράγωνον καὶ τρίγωνον.

187 *CCAG VIII/4*, 227.24: Ἐπιδέκατον λέγεται τὸ δεξιὸν τετράγωνον.

188 See Plutarch’s comment, *De Iside* 361a, that gods are τὰ δεξιὰ but daimons τὰ ἀντίφωνα.

PART 2

Gods and Daimons



Divergent Paths: Daimons and Astrology in Gnosticism and Mithraism

... as the rising places are proper to the gods, but the setting ones to daimons.

PORPHYRY, *On the Cave of the Nymphs in the Odyssey*, 29¹

The three previous chapters explored manifestations of good and bad daimons in both an astrological and cultural context. This chapter will continue to look at the dichotomy of daimons perceived as good or evil, and astrology as part of the apparatus, within two Greco-Roman and late antique religions, Gnosticism² and Mithraism. This examination will also involve the topic of gods and daimons in both a religious and astrological milieu. How do these religions characterise gods and daimons in their theology, combined with the way they use astrology? What is considered part of the material world, and how is that world perceived? How is the zodiac characterised? Are planets gods, or daimons, or something else? Is the perception of a god different from that of a daimon, and how is this reflected in religious practice? This investigation will be limited specifically to the intersection of daimon/god and astrology within the religions under consideration.

I have chosen to focus on Gnosticism and Mithraism because they exemplify two different approaches to these concerns, especially in the ways they treat astrological cosmology. What is treated as evil and daimonic in one religion is seen as beneficent and godly in the other. Astrology's cosmology is a material trap in one, an integral part of religious attainment in the other. Planetary orders are prominent in both religions, with different orders representing different theological doctrines and different theological outcomes. In some cases the two religions treat the very same astrological schemas in diametrically opposite ways. Investigating the reasons for this will shed light on

1 ὡς θεοῖς μὲν τὰ ἀνατολικά [sc. οἰκεῖα], δαίμοσι δὲ τὰ δυτικά. (Seminar Classics 609, 28.14–15).

2 Note that throughout this chapter I use 'Gnosticism' and related words purely as a scholarly convenience. The general category 'Gnosticism' can include beliefs and practices of many different sects, not all of whom agree with each other. My subsequent investigation will give the context of the practices of specific sects within their particular theological views. My thanks go to Attilio Mastrocinque for his advice on this chapter.

certain practices of both religions as well as how astrology, daimons and gods are incorporated into them.

1 Religious Dualism in the Air³

The stark contrast between good and bad daimons in the Empire and late antiquity is consistent with the dualism inherent in the religions of the era, not only Judaism and Christianity, but also Zoroastrianism,⁴ Gnosticism⁵ and the related Manichaeism.⁶ These religions particularly emphasise either/or, black and white antitheses between good and evil, though it is important to point out, as Culianu did, that their versions of dualism were not uniform and could reflect a pro- or anti-cosmic stance.⁷ Dualism certainly existed in Greek religion and philosophy before the Hellenistic period and the Greco-Roman era,⁸ but the syncretic atmosphere of the later period allowed cross-pollination

3 For a recent discussion of dualism as a concept see P. F. M. Fontaine, 'What is Dualism, and what is it not?' in *Light Against Darkness: Dualism in Ancient Mediterranean Religion and the Contemporary World*, ed. Armin Lange, et al., *Journal of Ancient Judaism Supplements* (Göttingen: Vandenhoeck and Ruprecht, 2011).

4 Roger Beck refers to its 'fundamental dualism' in R. Beck, 'Thus Spake Not Zarathustra: Zoroastrian Pseudepigrapha of the Greco-Roman World', in *A History of Zoroastrianism. Zoroastrianism under Macedonian and Roman Rule* (vol. 3), ed. Mary Boyce and Frantz Grenet (Leiden: E. J. Brill, 1991), 494.

5 K. Rudolph, *Gnosis: The Nature and History of Gnosticism*, trans. R. McL. Wilson, P. W. Coxon, and K. H. Kuhn (San Francisco: HarperCollins, 1987), 65: 'Dualism dominates the whole of gnostic cosmology, and particularly in relation to creation and its authors.' (For a mitigation of this view, however, see Z. Pleše, 'Gnostic Dualism', in *Light Against Darkness: Dualism in Ancient Mediterranean Religion and the Contemporary World*, ed. Armin Lange, et al., *Journal of Ancient Judaism Supplements* (Göttingen: Vandenhoeck and Ruprecht, 2011).)

6 John Dillon says Persian dualism influenced notions of evil daimons in late antiquity (Dillon, *The Middle Platonists*, 47), which is true as far as it goes. Yet I think a convergence of dualistic doctrines present at this time (including Jewish, Christian and Gnostic) influenced the notion of evil daimons. See D. R. McBride, 'The Egyptian Foundations of Gnostic Thought' (Ph.D. Thesis, University of Toronto, 1994), online at <http://colba.net/~drmcbr/Egyptian%20Gnosis/Contents/Contents.html> for Egyptian dualism especially related to Gnosticism.

7 I. P. Culianu, *Psychanodia I. A Survey of the Evidence concerning the Ascension of the Soul and its Relevance* (Leiden: E. J. Brill, 1983), 21.

8 See, e.g., S. Skovgaard Jensen, *Dualism and Demonology: The Function of Demonology in Pythagorean and Platonic Thought* (Copenhagen: Munksgaard, 1966).

that especially fed dualistic tendencies.⁹ As these religions flourished, so did their views of good and bad daimons. Moreover, astrology's incorporation into several religions of late antiquity, including Mithraism,¹⁰ Zoroastrianism and Gnosticism, merges an astral world view with dualistic principles.

In Zoroastrianism, light and darkness, good and evil, are exemplified in Ahura Mazda and Ahriman. The religion and culture of ancient Iran features both good and bad daimons. Diodorus Siculus claims that the Agathos Daimon¹¹ gave laws to Zarathustra, a claim also mentioned in a scholion to the Greater Alcibiades.¹² This scholion connects 'prosperous thought' (ἐπιτυχές νόημα) with

-
- 9 See van der Toorn, Becking and van der Horst, eds, *DDD*, 235–36, for dualism in this era. A. H. Armstrong, 'Dualism: Platonic, Gnostic, and Christian', in *Neoplatonism and Gnosticism*, ed. Richard T. Wallis and Jay Bregman (Albany, NY: State University of New York Press, 1992), 33–54, gives definitions of dualism and applies them to the different traditions flourishing at this time. B. A. Pearson, *Ancient Gnosticism: Traditions and Literature* (Minneapolis: Fortress Press, 2007), 334, distinguishes between the 'monistic type' of dualism (where evil devolves from a divine transcendent good God), and the dualism of 'eternally opposing principles of light and darkness.' For recent research on dualism, see A. Lange et al., eds., *Light Against Darkness: Dualism in Ancient Mesopotamian Religion and the Contemporary World*, *Journal of Ancient Judaism Supplements* (Göttingen: Vandenhoeck & Ruprecht, 2011), containing essays on dualism in Greek philosophy, Zoroastrianism, Judaism, Christianity, Gnosticism and Manichaeism.
- 10 B. Bakhouché, *L'Astrologie à Rome* (Louvain/Paris/Sterling, VA: Peeters, 2002), 148–56. Roger Beck is a leading proponent of astrology in Mithraism; see, e.g., R. Beck, *Planetary Gods and Planetary Orders in the Mysteries of Mithras* (Leiden/New York/Copenhagen: E. J. Brill, 1988); idem, *The Religion of the Mithras Cult in the Roman Empire: Mysteries of the Unconquered Sun* (Oxford: Oxford University Press, 2006); and his collected works on Mithraism, R. Beck, *Beck on Mithraism: Collected Works with New Essays* (Aldershot/Burlington, VT: Ashgate, 2004).
- 11 The Greek version of, probably, 'Vohu Manah' (Good Thought), one of the Amesha Spentas, but possibly Spenta Mainyu, 'beneficent spirit'; see A. de Jong, *Traditions of the Magi: Zoroastrianism in Greek and Latin Literature* (Leiden/New York: Brill, 1997), 264, 267.
- 12 Noticed by de Jong, *ibid.*, 267; see also 322. Diodorus writes (*Bibliotheca historica*, 1.94.2): 'Thus it is recorded that among the Arians Zathraustes claimed that the Good Spirit [ἀγαθὸς δαίμων] gave him his laws, among the people known as the Getae who represent themselves to be immortal Zamolxis asserted the same of their common goddess Hestia, and among the Jews Moyses referred his laws to the god who is invoked as Iao: (Trans. Oldfather, in Diodorus Siculus, *Bibliotheca historica*, vol. 1, trans. C. H. Oldfather (London/New York: Harvard University Press, 1933).) The scholion says: 'It is said that Zoroaster was six thousand years older than Plato. Some say he was a Greek, but others that he was the offspring of those who originated from the land beyond the great sea, and that he learned all wisdom from the Agathos Daimon, that is, "prosperous thought"'. Ζωροάστρης ἀρχαιότερος ἕξακισχιλίοις ἔτεσιν ἢ λέγεται Πλάτωνος· ὃν οἱ μὲν "Ἕλληνα, οἱ δὲ τῶν ἐκ τῆς ὑπέρ

the good daimon; we have already seen the daimon commonly associated with *nous* in Hellenistic philosophy and astrology.¹³ Plutarch lays out the tenets of Zoroastrianism, as he sees them, in *De Iside et Osiride* (369e–379c), stressing the stark dualism of Ahura Mazda (᾽Ωρομάζης) and Ahriman (Ἀρειμάνιος). Iran's flourishing demonology (daimons were said to control the weather, among other things) incorporated magical practices aimed at apotropaic measures against bad demons.¹⁴ Daimons were also associated with both fixed and shooting stars.¹⁵

Gnosticism is renowned for its severe delineations of good and evil deities, and its casting of the material world as evil. This dualism, which characterises the spiritual (in the form of a transcendent God) as good and the material (the physical world) as evil, is a special feature of Gnosticism.¹⁶ Gnostic cosmology is complex, with variations among sects, but generally holds that the entire world of planets and earth is ruled by evil daimons,¹⁷ sometimes called archons. The chief archon is also the creator of the world, a demiurge who rules either the seventh sphere or the eighth; below him are the spheres of the planets, each ruled by a different demon archon representing different passions or desires. In one sect's cosmology (the Ophites), the physical world is surrounded by the serpent Leviathan, pictured as an ouroboros.¹⁸ Humans, born

τὴν μεγάλην θάλασσαν ἠπείρου ὀρωμένων φασίν, πᾶσαν τε σοφίαν παρὰ τοῦ ἀγαθοῦ δαίμονος ἐκμαθεῖν, τουτέστιν ἐπιτυχοῦς νοήματος. (W. C. Greene, ed., *Scholia Platonica*, ed. Frederic D. Allen, John Burnet, and Charles Pomeroy Parker (Haverford, PA: American Philological Association, 1938), 100 [scholion to *Alcibiades*, 1.122A].)

- 13 See Chapter 1, 1.3. In *CH* X, 23.5–6 we read 'This [i.e. mind] is the good daimon' (Nock and Festugière, *CH* I, 124.22–125.1): οὗτος [sc. νοῦς] ἐστὶν ὁ ἀγαθὸς δαίμων.
- 14 P. Callieri, 'In the Land of the Magi', 17. Egyptian decans, too, were said to influence the weather (e.g. the Naos of the Decades: see C. Leitz, *Altägyptische Sternuhren* (Leuven: Peeters, 1995), 3–50, esp. 47; also D. Lehoux, *Astronomy, Weather and Calendars in the Ancient World: Parapegmata and Related Texts in Classical and Near-Eastern Studies* (Cambridge: Cambridge University Press, 2007), 123–27 [with commentary on Leitz], 136–37).
- 15 Callieri, 'In the Land of the Magi', 17.
- 16 Rudolph, *Gnosis*, 60; see also Pearson, *Ancient Gnosticism*, 12–19, for descriptions of Gnostic dualism. I thank Attilio Mastrocinque (personal communication, 7 March 2015) for clarification of this description.
- 17 See the discussion of the demonisation of the cosmos and Gnostic dualism in I. P. Couliano, *Expériences de l'extase. Extase, ascension et récit visionnaire de l'Hellénisme au Moyen Âge* (Paris: Payot, 1984), ch. 2, 45–62; and Culianu, *Psychanodia*, 19–21.
- 18 See Origen, *Contra Celsum*, VI, 28–31. The previous description is drawn from Rudolph, *Gnosis*, 67–69, which has an accompanying 'Ophite Diagram' showing the cosmology; see also A. J. Welburn, 'Reconstructing the Ophite Diagram', *NT* 23, no. 3 (1981): 261–87.

into the world of matter, have a divine spark from the spiritual realm above the earth; they can be saved from the corruption of matter by *gnosis*, which Rudolph translates as 'insight'.¹⁹ However, this severe cosmology depicting the planets as evil archons and demons can be modified in some Gnostic texts, for example the *Pistis Sophia*.²⁰

Manichaeism, as a Gnostic sect,²¹ continued on the path of extreme dualism (coincidentally its founder, Mani, claimed to have a personal daimon).²² A world of light and good (God and aeons) battles a world of darkness and evil (demons and archons). But unlike ordinary Gnostic extremism, where the world is irretrievably corrupt, in Mani's cosmology the world contains bits of light and therefore is not completely demonised. The sun and moon are purely light; the five planets and stars of the zodiac are a mixture of light and darkness.²³

Neo-Platonism, too, maintained a dualistic strand, exemplified by its treatment of daimons, within its monism.²⁴ The Chaldean Oracles' good *iunges* and bad sublunar, elemental daimons, formed of evil matter,²⁵ may have influenced some Neo-Platonic dogma about good and bad daimons.²⁶

19 Rudolph, *Gnosis*, 70.

20 See, e.g., *PS* IV, 136–137, where there are good archons who follow the light, and Zeus is also a good planet called 'Little Sabaoth'.

21 S. Hornblower and A. Spawforth, eds, *Oxford Classical Dictionary* (Oxford/New York: Oxford University Press, 1996), s.v. Manichaeism, 917. Though perhaps it would not be correct to characterise him or Manichaeism as Gnostic, since Attilio Mastrocinque informs me (personal communication, 7 March 2015) that Mani was an Elkasaite.

22 P. Brown, 'The Diffusion of Manichaeism in the Roman Empire', *JRS* 59, no. 1/2 (1969): 92–103, here 94.

23 See Rudolph, *Gnosis*, 336–37; Pearson, *Ancient Gnosticism*, 303.

24 G. Shaw, *Theurgy and the Soul: The Neoplatonism of Iamblichus* (University Park, PA: The Pennsylvania State University Press, 1995), 40.

25 Julian, *Chaldean Oracles*, ed. Majercik, 13–14. See, in the *Chaldean Oracles*, e.g., Frs 88, 90, 91, 135, 149, 157.

26 See Lewy and Tardieu, eds, *Chaldaean Oracles and Theurgy*, esp. Ch. 5, 'Chaldaean Demonology'; F. W. Cremer, *Die Chaldäischen Orakel und Jamblich De mysteriis* (Meisenheim am Glan: A. Hain, 1969), esp. 68–86 (on daimons); and, for the influence of the Chaldean Oracles on theurgy, R. Smith, *Julian's Gods: Religion and Philosophy in the Thought of Julian the Apostate* (London/New York: Routledge, 1995), 91–110. See also above, Chapter 4, 1.3 ('Greek Demons'), 125–26.

2 Daimons and Astrology in Gnosticism

This section examines the juncture between Gnosticism's flourishing demonology and its astrological cosmology.²⁷

Gnostic dependence on astrological cosmology is highlighted in works like the *Apocryphon of John*, *On the Origin of the World*, the Ophite Diagram and the *Pistis Sophia*, as well as the recently examined *Gospel of Judas*.²⁸ Gnostic cosmologies incorporate the planets and zodiac. The Gnostics assert that the planets are ruled by archons, considered to be evil daimons. More astrological influence is revealed in Gnostic fondness for hierarchies of seven and twelve: in addition to the seven planetary archons, there are twelve angels who correlate to the signs of the zodiac. The combination of these groups' astrological associations with their daimonic indications will now be explored.

2.1 Planetary Archons

The seven planetary archons are considered to be demons ruling over the world of corruptible matter. The creator of the planetary realms is a *demiourgos* often called Yaldabaoth. Thus in Gnosticism, the planetary *gods* of the Greeks are transformed into archontic *demons*, each ruling a material world which the soul must pass through and transcend in its ascent to heaven. (Compare

27 It will not cover general indications of astrology in a religion or a text, since the remit of this study is the daimon *and* astrology. One caveat should be kept in mind regarding religious texts: just because they employ astrological terminology or cosmology is not necessarily an indication of any deep knowledge of either theoretical or practical astrology; they merely draw upon (perhaps incorrectly or incompletely), and reflect, a common astrological worldview. In fact, it is almost fruitless to correlate what seem like astrological doctrines with actual astrological doctrines, as some have tried to do. Often the former are truncated for the religion's or text's own purposes, misunderstood or otherwise bowdlerised.

28 Some examples of work on these texts include: A. J. Welburn, 'The Identity of the Archons in the "Apocryphon Johannis"', *VChr* 32, no. 4 (1978): 241–54; Welburn, 'Reconstructing the Ophite Diagram'; A. von Lieven, 'Gnosis and Astrology. 'Book IV' of the Pistis Sophia', in *Under One Sky. Astronomy and Mathematics in the Ancient Near East*, ed. John M. Steele and Annette Imhausen (Münster: Ugarit-Verlag, 2002); J. van der Vliet, 'Fate, Magic and Astrology in *Pistis Sophia*, Chaps 15–21', in *The Wisdom of Egypt: Jewish, Early Christian and Gnostic Essays in Honour of Gerard P. Luttikhuisen*, ed. Anthony Hilhorst and George van Kooten (Leiden/Boston: Brill, 2005); A. D. DeConick, 'Apostles as Archons: The Fight for Authority and the Emergence of Gnosticism in the Tchacos Codex and other Early Christian Literature', in *The Codex Judas Papers. Proceedings of the International Congress on the Tchacos Codex held at Rice University, Houston, Texas, March 13–16, 2008*, ed. April D. DeConick (Leiden/Boston: Brill, 2009).

the Chaldean Oracles, whose bad daimons are under the control of *Phusis*, Nature [matter], while the good *iunges* are under the control of Hekate.) An obvious Jewish influence seen in the names of the archons²⁹ may have contributed to the transformation from god to demon, in that the planets could not be gods.

2.1.1 Orders, Lists and Names of Archons

The archons are listed in varying orders, and varying names, in Gnostic texts. When seven archons are listed together, connections to planets are often assumed,³⁰ especially since some names have undisputed planetary connections.³¹ While some can easily be matched with the planet they are said to rule, others are more problematic. Each archon ought to be consistently associated with a particular planet (here including the Sun and Moon), but unfortunately this does not occur in practice. Therefore, scholarly debate is ongoing as to which planets go with which archons. In an attempt to organise and clarify this issue, I shall look closely at the following six texts employing archon names among those used to coordinate names and planets.³²

-
- 29 D. E. Aune, in van der Toorn, Becking and van der Horst, eds, *DDD*, s.v. 'Archon', 85. For Jewish names and terminology in Greek magical texts, see G. Bohak, 'Hebrew, Hebrew Everywhere? Notes on the Interpretation of the *Voces Magicae*', in *Prayer, Magic, and the Stars in the Ancient and Late Antique World*, ed. Scott Noegel, Joel Walker, and Brandon Wheeler (University Park, PA: The Pennsylvania State University Press, 2003), esp., for our purposes, 71. Welburn, 'Identity', also discusses Jewish affinities, 245–46. See also the excellent study of A. Mastrocinque, *From Jewish Magic to Gnosticism*.
- 30 In the case of Irenaeus, at 1, 30.9 he specifically says '... moreover, the holy Hebdomad is the seven stars which they call planets' (Rousseau-Doutreleau, Tome 1/2, 376, ll.173–174: 'Sanctam autem Ebdomadem septem stellas quas dicunt planetas...').
- 31 Origen specifically associates Yaldabaoth with Saturn ('Phainon'); and Iao has close associations with the Sun (see below).
- 32 Other correspondences in additional texts have been proposed (e.g., see M. Tardieu, *Écrits Gnostiques. Codex de Berlin*, trans. Michel Tardieu (Paris: Les Éditions du Cerf, 1984), 288; T. Rasimus, *Paradise Reconsidered in Gnostic Mythmaking: Rethinking Sethianism in Light of the Ophite Evidence* (Leiden/Boston: Brill, 2009), 104; and A. H. B. Logan, *Gnostic Truth and Christian Heresy: A Study in the History of Gnosticism* (Edinburgh: T. & T. Clark Ltd., 1996), 136 n. 43 [endnote on 159]), but I concentrate here on texts with the most similar names, and those most often included in scholarly discussions. For these texts I use the following editions, whose full citations are in the bibliography (Bonner is also cited here in full). *Origin of the World*: Layton, 12–134. Brummer Amulet: C. Bonner, 'An Amulet of the Ophite Gnostics', *Hesperia Supplements* 8 (1949): 43–46; 444; idem, *Studies in Magical Amulets, chiefly Graeco-Egyptian* (Ann Arbor: University of Michigan Press, 1950), 135–38 and Plate IX (no. 188). Irenaeus: Rousseau and Doutreleau, Tome 2, 368–69. 'Coptic Book':

TABLE 5.1 *Six archon lists*

<i>Origin of the World</i>	Brummer	Irenaeus, <i>Against Heresies</i> I, 30.5	'Coptic Book' P. Berlin 20915, Fr. 128,5–8 ³³	Origen, <i>Contra Celsum</i> VI, 31, 32	<i>Apocryphon of John</i> NHC II 11,26–34/ BG 41,17–42,6/NHC III 17,21–18,6/NHC IV 18,17–23
Yaldabaoth	Ia<ldabaoth?>	Ialdabaoth	[Ialda]baoth	Ialdabaoth	Athoth/Iaoth
Iao	Iao	Iao	[Iao]	Iao	Eloaiou/Eloaios
Sabaoth	Sabaoth	Sabaoth	[S]abaoth	Sabaoth	Astaphaios/Astaphaios
Adonaios	Adonai	Adonaeus	Adonai[s]	[Adonaios] ³⁴	Iao/Iao
Eloaios	Eloai	Eloeus	[E]loaios	Astaphaios	Sabaoth/Adonaios
Oraios	Horeus	Oreus	Oraios	Ailoaios	Adonin/Adoni
Astaphaios	Astaphaios	Astaphaeus	A[staphaios]	Horaios	Sabbede/Sabbataios/ Sabbadaios

In five of these six lists (*Origin of the World*, Brummer Amulet, Irenaeus, the 'Coptic Book' and Origen) the names and orders are the most similar, with all five listing Yaldabaoth first.³⁵ Three of the five (*Origin of the World*, Brummer

Schenke Robinson, Schenke and Plisch, vol. 1, 256–57 (No. 128); vol. 2, 130. Origen, *Contra Celsum*: Borret, Tome 3, 254–59. *Apocryphon of John*: Waldstein and Wisse.

33 This order is according to my proposed reconstruction, based on similar lists. Though the editors' reconstruction in the critical edition is painstaking, the fragmented text is so lacunose that different interpretations could be made of it. See G. Schenke Robinson, H.-M. Schenke, and U.-K. Plisch, eds., *Das Berliner "Koptische Buch" (P 20915)*, 2 vols, Corpus scriptorum Christianorum Orientalium. Scriptores Coptici (Leuven: Peeters, 2004), vol. 1, Fragment 128, 256 (photograph) and 257 (transcription). The lacunae in question occur right in the middle of the list of names. The editors' reconstruction posits the order Ialdabaoth-Sabaoth-Adonaios-Iaoth-Eloaios-Oraios-Astaphaios, but the empty space after what is probably Ialdabaoth could accommodate 'Iao', with Sabaoth following, then Adonaios, omitting the reconstructed 'Iaoth' which follows. The list would then exactly match those of Irenaeus, the Brummer amulet and the *Origin of the World* (as in Table 5.1). I am grateful to Leo Depuydt and Micah Ross for palaeographical support and advice; the conclusions are my own.

34 Adonaios does not appear in VI.31, where the prayers for the ritual are given, but appears in VI.32 as an archontic name derived from Hebrew.

35 For Origen, I follow the actual order in which he discusses each archon, not the number he assigns it (e.g. 'seventh' for Yaldabaoth).

Amulet and Irenaeus) have an identical order of names, and the 'Coptic Book' may very well align with them (see n. 33). Two texts, Irenaeus and Origen, refer to 'Ophite' diagrams.³⁶ Thus four of the six lists are likely identical. Origen uses the same names, and his first three names align with the other four lists, but he omits Adonaios (see n. 34) and moves Astaphaios above Ailoiios and Oraios.³⁷ *The Apocryphon of John* is even more of an outlier. Its list does not begin with Yaldabaoth, some of its names are different and its name order, even if merely reversed, does not match very well with the other five (and especially with the lists containing names in identical order).

In the assignment of archons to planets, scholars agree that Ialdabaoth must be Saturn: Origen makes a specific correlation between Ialdabaoth and 'Phainon' (the old name for the planet Saturn).³⁸ Some have assumed that a soul ascent or descent is taking place through the planetary spheres, which would suggest planets assigned to the archons in Chaldean order starting with Saturn for Ialdabaoth.³⁹ Welburn took this position as he sought to align Origen's text

36 Scholarship on the Ophite diagrams includes H. Leisegang, *Die Gnosis* (Leipzig: A. Kröner, 1924), 168–74 (with diagram); T. Hopfner, 'Das Diagramm der Ophiten', in *Charisteria Alois Rzach zum achtzigsten Geburtstag dargebracht* (Reichenberg: Stiepel, 1930) (also with diagrams drawing on Leisegang); Welburn, 'Reconstructing the Ophite Diagram'; B. Witte, *Das Ophiten-diagramm nach Origenes' Contra Celsum VI 22–38* (Altenberge: Oros Verlag, 1993); Logan, *Gnostic Truth*, 135–37; M. G. Lancellotti, 'Gli gnostici e il cielo. Dottrine astrologiche e reinterpretazioni gnostiche', *Stude e materiali di Storia delle Religioni* 66/n.s. 24, no. 1 (2000): 71–108, esp. 73–86; and, most recently, N. Denzey, 'Stalking Those Elusive Ophites: The Ophite Diagrams Reconsidered', in *Essays in Honour of Frederik Wisse*, ed. Warren Kappeler (Montreal: ARC: Journal of the Faculty of Religious Studies, McGill University, 2005), 89–122; Rasimus, *Paradise*, 107–23; and A. D. DeConick, 'The Road for the Soul is Through the Planets: The Mysteries of the Ophians Mapped', in *Practicing Gnosis: Ritual, Magic, Theurgy and Liturgy in Nag Hammadi, Manichaean and Other Ancient Literature. Essays in Honor of Birger A. Pearson*, ed. April D. DeConick, Gregory Shaw, and John D. Turner (Leiden/Boston: Brill, 2013), 37–74.

37 Some scholars have noticed the variation in Origen's order, e.g. Logan, *Gnostic Truth*, 136 and n. 44 (p. 159), 138; and Denzey, 'Stalking Those Elusive Ophites', 92–93; others, e.g. Rasimus, *Paradise*, 110, ignore it: '(6.31–32), which corresponds almost exactly both with Irenaeus' list (*Adv. haer.* 1.30.5), and with most of the other known lists of the seven.' See the discussion of DeConick's proposal for this text below.

38 See F. Cumont, 'Les noms des planètes et l'astrolatrie chez les Grecs', *AC* 4, no. 1 (1935): 5–43.

39 See particularly R. van den Broek, *Studies in Gnosticism and Alexandrian Christianity* (Leiden: E. J. Brill, 1996), 69–85; Welburn, 'Reconstructing the Ophite Diagram', 263–64.

TABLE 5.2 *Planetary orders*

Chaldean	Platonic a.k.a. Egyptian	Day of the Week (beginning with Saturday)	Zodiacal (beginning with Capricorn)
Saturn	Saturn	Saturn	Capricorn/Aquarius (Saturn)
Jupiter	Jupiter	Sun	Pisces (Jupiter)
Mars	Mars	Moon	Aries (Mars)
Sun	Mercury	Mars	Taurus (Venus)
Venus	Venus	Mercury	Gemini (Mercury)
Mercury	Sun	Jupiter	Cancer (Moon)
Moon	Moon	Venus	Leo (Sun)

with the *Apocryphon of John*.⁴⁰ Hopfner proposed a Platonic order.⁴¹ However, a day-of-the-week order has also been suggested (most recently by Denzey).⁴² While there are points of contention in her argument, for our four likely

40 Welburn, 'Identity', 244–45.

41 Hopfner, 'Das Diagramm der Ophiten', 88.

42 Denzey, 'Stalking Those Elusive Ophites,' 100–02, citing Robert Grant (*Gnosticism and Early Christianity*, 51) and Simone Pétrement (*A Separate God*, 65) as previous proponents of this scheme (but I would not characterise Grant's position as solidly in the day-of-the-week camp). S. Pétrement, 'Le mythe des sept archontes créateurs peut-il s'expliquer à partir du christianisme?' in *Le origine dello Gnosticismo. Colloquio di Messina 13–18 aprile 1966*, ed. Ugo Bianchi (Leiden: E. J. Brill, 1967) (= [with modifications] S. Pétrement, *Le Dieu séparé: les origines du gnosticisme* (Paris: Éditions du Cerf, 1984), 79–109, esp. 100–01), here 477–81, makes the interesting proposal that the seven archons' links to creation stem from and are associated with the 7 days of the Genesis creation myth; only later did they correspond to the planetary names of the 7 days of the week and their astrological origin. See also N. Denzey Lewis, *Cosmology and Fate in Gnosticism and Graeco-Roman Antiquity: Under Pitiless Skies* (Leiden/Boston: Brill, 2013), 48; I agree with Denzey Lewis that Pétrement perhaps makes too much of 'astrological' planets not *creating* the world, but there is merit in the latter's proposal of a link with the 7 days of creation in Genesis and a subsequent connection of the seven archons to planets each ruling a day of the week. (Both systems are based on sequential time.) In 1974 Michel Tardieu had already assumed, but did not assign, an archontic/planetary connection to days of the week: 'Occupant les sept cieux, Jaldabaoth et ses fils sont les divinités planétaires présidant aux jours de la semaine': M. Tardieu, *Trois mythes gnostiques. Adam, Éros et les animaux d'Égypte dans un écrit de Nag Hammadi (II, 5)* (Paris: Études Augustiniennes, 1974), 64.

identical cases a weekday order does make the most sense. Among the four, the *Origin of the World* mentions ‘Sambathon, which is the week’⁴³ and Irenaeus (I, 30.4) associates his list with a ‘hebdomad’⁴⁴ which can mean ‘week’ (i.e. a period of seven days) but also ‘a number of seven’.⁴⁵ A day-of-the-week order also fits well with these four texts’ order of names and associations of archons with planets.⁴⁶

The names for the weekdays and their associated planets form a complex system which, in fact, depends on the Chaldean order of the planets to assign planetary hours, a staple of late antique astrological practice.⁴⁷ The procedure is described, using Egyptian months, by Vettius Valens (b. 120 CE), who calculates his own birth day as an example (it turns out to be a day of Hermes).⁴⁸ Though the system was in place earlier,⁴⁹ Cassius Dio (fl. 200–222) makes a full explanation in his *Roman History*,⁵⁰ and it is given thorough treatment by Paulus Alexandrinus (fl. 378 CE).⁵¹ The usual beginning of the week at this time

43 Layton, ed., 36–37: $\text{C}\alpha\mu\beta\alpha\theta\alpha\varsigma \epsilon\tau\epsilon \theta\epsilon\beta\lambda\omicron\mu\iota\alpha\varsigma$ (101.27–28), trans. Layton et al.

44 ‘Sic quoque Ebdomas perfecta est . . .’. Also a ‘holy Hebdomad’ at I, 30.9 and I, 30.10.

45 LSJ, 466, s.v. $\epsilon\beta\delta\omicron\mu\acute{\alpha}\varsigma$. Also Lewis and Short, 843, s.v. *hebdomas*, ‘the number seven, seven days’.

46 Iao has associations with the Sun (see the evidence laid out in Z. Pleše, *Poetics of the Gnostic Universe: Narrative and Cosmology in the Apocryphon of John* (Leiden: Brill, 2006), 188 and n. 42); Eloaios and Astaphaios are commonly ascribed by scholars to Mercury and Venus respectively.

47 See Appendix I.A, 1.4 (‘Sect and other Ordering Schemes’), 404.

48 Valens, *Anthology*, I, 9.3–5 (Pingree, 25.18–22): ‘The order of the stars [*i.e. planets*] in relation to the days goes thus: Sun, Moon, Ares, Hermes, Zeus, Aphrodite, Kronos. The arrangement of the planetary zones is thus: Kronos, Zeus, Ares, Sun, Aphrodite, Hermes, Moon. From this arrangement the hours are designated; from the hours, the day of the subsequent star [*planet*]: ἡ δὲ τάξις τῶν ἀστέρων πρὸς τὰς ἡμέρας οὕτως ἔχει. Ἡλῖος, Σελήνη, Ἄρης, Ἐρμῆς, Ζεὺς, Ἀφροδίτη, Κρόνος. ἡ δὲ τῶν ζωνῶν διάθεσις οὕτως. Κρόνος, Ζεὺς, Ἄρης, Ἡλῖος, Ἀφροδίτη, Ἐρμῆς, Σελήνη. ἐκ ταύτης δὲ τῆς διαθέσεως αἱ ὥραι σημαίνονται, ἐκ δὲ τῶν ὥρων ἡ ἡμέρα τοῦ ἐξῆς ἀστέρος.

49 See F. Boll, ‘Hebdomas’, in *RE*, Band VII.2 (Stuttgart: J. B. Metzler, 1912), cols 2547–87, here 2558, 2574, who cites Plutarch (ca. 45–120 CE), *Quaest. conv.* IV, 7 (672c) and also mentions evidence from Pompeii.

50 Dio Cassius, *Roman History*, trans. Earnest Cary, 9 vols. (Cambridge, MA: Harvard University Press, 1914–1927), here vol. III, Book 37.18–19.

51 Paulus Alexandrinus, *Introduction*, Ch. 21 (Boer, 41–45); see above, Chapter 4, Table 4.1 of planetary hours, 135.

was Saturday,⁵² which aligns with the lists' beginning with Ialdabaoth. It produces this schema:

Ialdabaoth, Saturn, Saturday
 Iao, Sun, Sunday
 Sabaoth, Moon, Monday
 Adonaios, Mars, Tuesday
 Eloaios, Mercury, Wednesday
 Oraios, Jupiter, Thursday
 Astaphaios, Venus, Friday

The fact that two of these texts are Gnostic (*Origin of the World*, Brummer amulet), one early Christian (the 'Coptic Book'), one anti-Pagan (Irenaeus, who is also anti-Gnostic) and one (the amulet) likely to be used in practice, demonstrates the broad dissemination of this list order. The Irenaeus text (written in the late second century CE) is probably closest to the original creation of the list.

Origen's text (VI.31) presents the last three names in a different order, and omits Adonaios. Some scholars have assumed Adonaios was left out by mistake,⁵³ but April DeConick has recently proposed an ingenious solution to Origen's discrepancies.⁵⁴ Drawing on the example of Mithraic practices and Numenius's account of the descent and ascent of souls through the Gates of Cancer and Capricorn (see Porphyry, *De antro* 21–24, Seminar Classics 609, 20–25), she has determined a sensible reason for Origen's name order and omission. DeConick does not discuss similar texts, but concentrates only on Origen and Celsus, especially the prayers said in the ritual described by Origen in which Adonaios does not appear. She takes this ritual as one performed by an 'Ophian-Christian'⁵⁵ practitioner as a form of spiritual initiation⁵⁶ rather than an ascent of the soul after death. The initiate begins the spiritual ascent

52 Bouché-Leclercq, *AG*, 482–83, emphasises the importance of the Sabbath, which is linked to Saturn, in Judaism. Both Cassius Dio and Paulus begin the week/planetary hour scheme with Saturday.

53 E.g. Chadwick: Origen, *Origen: Contra Celsum*, trans. and annot. Henry Chadwick (Cambridge: Cambridge University Press, 1965), 348 n. 1; Welburn, 'Reconstructing the Ophite Diagram', 264; Welburn, 'Identity', 244; Lancellotti, 'Gli gnostici e il cielo', 74 n. 17; Denzey, 'Stalking Those Elusive Ophites', 109; Witte, *Das Ophiten-diagramm*, 122.

54 DeConick, 'Road for the Soul', esp. 57–63.

55 *Ibid.*, 60.

56 *Ibid.*, 64–67. Others have also suggested a ritual during life, anticipating the requirements of the soul's ascension after death: see Couliano, *Expériences de l'extase*, 125 (cited in Lancellotti, 79 and n. 43); Lancellotti, 'Gli gnostici e il cielo', 78–80; Witte,

at the gate of Capricorn and moves through the zodiacal realms in sequence (Aquarius-Ialdabaoth, Pisces-Iao, Aries-Sabaoth, Taurus-Astaphaios, Gemini-Ailoaios, Cancer-Horaios) (see Table 5.2, Zodiacal order). This scheme accounts for the order of the last three archon names (Astaphaios-Taurus, Ailoaios-Gemini, Horaios-Cancer) and the omission of Adonaios (whom DeConick aligns with the Sun), because Leo is absent in this part of the zodiac.⁵⁷ Thus the initiate depends on the zodiac as a conduit to the planets and their associated archons. While I have reservations about some of DeConick's observations,⁵⁸ the scheme in general appears sound in this context. It differs from other texts' lists because it serves a different purpose.

A different purpose applies as well for the list in the *Apocryphon of John*. This has been obscured by previous scholarly analysis, which has generally tried to tie the lists of these five texts to the differently ordered list in *ApJohn*, based on similarity of the archon names, and to assign the same order of planets regardless of archon order. But *ApJohn*'s version has peculiarities with no parallel in the texts just described.⁵⁹ First, it contains the names Athoth and Sabbede/Sabbadaios instead of Horaios and Ialdabaoth. Second, it begins with Athoth, not Ialdabaoth.⁶⁰ Third, it links the archons to animal faces.⁶¹ Fourth, and most important for assigning archons to planets, its archon order is different: it ends, instead of begins, with Sabbede (assumed to be Ialdabaoth), and it places Iao in the centre.

Das Ophiten-diagramm, 101–02. See this view regarding Mithraic ritual in Beck, *Planetary Gods and Planetary Orders*, 77–79.

57 DeConick, 'Road for the Soul', 58–60.

58 She relates her proposed scheme to the Mithraic Housesteads monument, 'only in this case with the Cancer-Leo and Capricorn-Aquarius boundaries.' *Ibid.*, 61. I argue that the main purpose of this sculpture is different: see below, 3.2., 191–92.

59 Logan, *Gnostic Truth*, 136 also noticed the difference in the *ApJohn* text ('...its version remains distinctive...'), but his analysis takes a different approach than mine here. R. M. Grant, *Gnosticism and Early Christianity* (New York: Columbia University Press, 1959), 46–51, assuming an association with the week because of the use of 'hebdomad' and 'Sabbataios' in *ApJohn*, admits that 'other documents... do not work out exactly' with *ApJohn* (p. 51; he has previously mentioned Origen and the Brummer amulet). Although Denzey, 'Stalking Those Elusive Ophites', 100, acknowledges the differences between *ApJohn* as a 'so-called Sethian' text (p. 91) and the 'Ophite' ones, she too ties *ApJohn* to a week order (emphasising the word 'hebdomad' as symptomatic of the week) rather than a Chaldean order.

60 Though it is possible the variants 'Iaoth' or 'Aoth' could be abbreviations of Ialdabaoth, this does not resolve the name order deviations, and Sabbadaios (and variant spellings) is commonly thought to be Ialdabaoth.

61 The association of animals with Hebrew angel names in Celsus/Origen (vi.30) does not match very well with the assignments in *ApJohn*.

TABLE 5.3 *Archon names and their faces in the Apocryphon of John, with corresponding planet, and zodiac sign from the Dodekaoros*

<i>NHC II 11,26–34/BG 41,16–42,7/ III 17,21–18,8</i> ⁶²	<i>Planet</i>	<i>Prosōpon</i>	<i>Zodiac sign (Dodekaoros)</i>
Athoth/Iaoth/Aoth	Moon	Sheep/Lion	(Virgo)
Eloiaos/Eloaiu/Eloaios	Mercury	Ass/Ass	(Leo)
Astaphaios/Astaphaios/Astophaios	Venus	Hyena/Hyena	
Iao/Iao/Iazo	Sun	Seven-headed Dragon/ Seven-headed Serpent	(Gemini)
Sabaoth/Adoniaos/Adoniaos	Mars	Serpent/Dragon	
Adonin/Adoni/Adonin	Jupiter	Ape/Ape	(Capricorn)
Sabbede/Sabbataios/Sabbadaios	Saturn	Fire/Fire	

The placement of Iao in the centre is telling. Iao is often associated with the Sun and, coupled with the uncontroversial assignment of Sabbede to Saturn, gives a strong indication here of (reverse) Chaldean order (see Table 5.2). This proposal has the virtue of aligning the archons here to more of the same planets they receive in the other lists in weekday order, something other proposals (such as Welburn's and Denzey's) have not been able to do.⁶³ Athoth's assignment to the Moon also has historically strong connections (see below, 2.2, on the zodiac signs in Gnostic texts). The descriptions of this list as 'the hebdomad of the week' need not force us to a weekday order in this instance. Since the Chaldean order is an essential component of the system assigning the names of weekdays via planetary hours, what we see here is emphasis placed on the 'seven' who systematise the week and give the days their names.

The archons in the *Apocryphon of John* also have faces (*prosōpa*),⁶⁴ a word used in astrological texts when assigning planets to the decans. These can be seen in Table 5.3 above.

62 As in Welburn, 'Identity', 243. I follow Welburn's planetary assignments, but add correlations to zodiac signs.

63 Thus Iao is the Sun, Adoniaos is Mars (at least in one version of *ApJohn*), Astaphaios is Venus and Eloaios is Mercury. Athoth is linked to the Moon in both planetary and zodiac lists.

64 *Pistis Sophia*, III, 126 (Schmidt/MacDermot, 317–19) also lists twelve archons with animal faces.

These mostly animal assignments are not unlike some Egyptian depictions of decans.⁶⁵ They also suggest the Egyptian *dodekaoros*, which assigns hours to animals: the lion, ass, dragon, serpent and ape are animals in the *dodekaoros*, derived from constellations which co-rise with the zodiac signs (*paranatellonta*).⁶⁶ The lion links to Virgo, the ass to Leo, the dragon/serpent to Gemini, the ape to Capricorn. While the archontic faces may or may not directly derive from astrological faces, decans or *dodekaoros*, the systems here are similar. In astrology, each planetary god has a certain face, connected with a certain zodiac sign or constellation, and with a certain animal; the Gnostic tradition is the same, except that instead of gods, daimonic beings either carry out conditions mandated by the gods in these particular locations, or are part of the circumstances under which the conditions appear. Since the astrological assignments, both for decans and *dodekaoros*, appear earlier than Gnostic ones, they provide a rationale or template for the Gnostic system in use here. Similarly, daimonic associations with the archons/planets/*prosōpa* in Gnosticism may reinforce daimonic connections with the *dodekaoros* and decans as *prosōpa* in astrology.

What conclusions can we draw about the different orders depicted in these texts? Given DeConick's proposal for Origen's list, and my own interpretation of the *ApJohn* list, I propose that these six texts represent three different systems of archon orders addressing three different concerns of their practitioners. The weekday order of four of the texts represents a cosmic creation, *in time*, of archons and corresponding planets, and therefore relates a chronological archontic cosmogony. Origen's order, as DeConick asserts, supports a ritual of spiritual initiation connected with zodiacal/archontic ascent, with the zodiacal houses of the planets as conduits. *ApJohn*'s lists are also cosmological, related to the four weekday-order texts,⁶⁷ but take a different cosmological perspective in which the order of planets *in space* are emphasised. Here the planets and their archons who 'command' the seven heavens (*ApJohn*, III 17,20–21; BG 41,16–17) appear in their order as perceived from the earth, beginning with the Moon and moving upwards to Saturn. (That this Chaldean order is commonly associated with astrology, considered an exemplar of the material world, emphasises the archons' complicity in materiality.) Yet no matter what order is depicted, the fact is that all these facets of Gnostic cosmology tie both zodiac signs and planets to demonic archons. The practitioner's ultimate

65 As seen in the Grand tablets, whose Egyptian connections are undisputed. See Chapter 6, 4.9.

66 See Chapter 6, 1.5, for more on the *dodekaoros*.

67 In that Chaldean order creates the days of the week.

goal would be to escape the evil and demonic materiality of this cosmos by ascension into the realms of light and deity.

2.2 *Zodiacal Angels, Authorities and Aeons*

Both the *Apocryphon of John* and the *Holy Book of the Great Invisible Spirit* (a.k.a. *Gospel of the Egyptians*) give lists of twelve angels or aeons which, all commentators agree, correspond to the twelve zodiac signs.⁶⁸ They are also called ‘*Exousiai*’ (authorities). While some Gnostic cosmologies include the zodiac as part of the evil material cosmos, others (such as the *Pistis Sophia*),⁶⁹ place the zodiac under the control of aeons or angels, and give it power over the bad planetary archons.

The lists in *ApJohn* and the *Holy Book* are very similar, beginning with Iaoth/Athoth and ending with Belias:

TABLE 5.4 *Assignments of aeons-angels-exousiai to the zodiac and planets*

<i>Apocryphon of John</i> (II 10,28–11,3; III 16,20–17,5; BG 40,4–18)	<i>Holy Book of the Great Invisible Spirit</i> (III 58,7–22; IV 70,1–5)	Welburn's zodiac and planet assignment	My proposed zodiac and planet assignment
Athoth/Haoth/Iaoth	Athoth	Leo – Sun	Cancer – Moon
Harmas/Hermas	Harmas	Virgo – Mercury	Gemini – Mercury
Kalila-Oumbri/Galila	Galila	Libra – Venus	Taurus – Venus
Yabel/Yobel	Yobel	Scorpio – Mars	Aries – Mars
Adonaiou called Sabaoth/Adonaios	Adonaios/ Sabaoth	Sagittarius – Jupiter	Pisces – Jupiter
Kain called sun/Kainan Kasin called sun/ Sabaoth	Cain (the sun)	Capricorn – Saturn	Aquarius – Saturn

68 Usually scholars do not identify them with a particular zodiac sign, but simply say they represent the zodiac; see, e.g. Pearson, *Ancient Gnosticism*, 81; Rudolph, *Gnosis*, 79; Meyer, ed., *The Nag Hammadi Scriptures*, 115, n. 50. However Tardieu, *Écrits Gnostiques*, 277–85, ascribes them to the zodiac signs in order beginning with Aries. (For a synopsis of the *Apocryphon of John* texts, see M. Waldstein and F. Wisse, *The Apocryphon of John: Synopsis of Nag Hammadi Codices II, 1; III, 1; and IV, 1; with BG 8502,2* (Leiden/New York/Cologne: E. J. Brill, 1995).)

69 See Welburn, ‘Identity’, 248.

<i>Apocryphon of John</i> (II 10,28–11,3; III 16,20–17,5; BG 40,4–18)	<i>Holy Book of the Great Invisible Spirit</i> (III 58,7–22; IV 70,1–5)	Welburn's zodiac and planet assignment	My proposed zodiac and planet assignment
Abel/Kainan Kasin called sun/Kainan Kae Kain who is sun	Abel	Aquarius – Saturn	Capricorn – Saturn
Abrisene/Abiressia/ Abiressine	Akressina	Pisces – Jupiter	Sagittarius – Jupiter
Yobel	Youbel	Aries – Mars	Scorpio – Mars
Armoupieel/ Armoupiael/ Harmoupiael	Harmoupiael	Taurus – Venus	Libra – Venus
Melcheir-Adonin/ Adonin	Archir-Adonin	Gemini – Mercury	Virgo – Mercury
Belias	Belias	Cancer – Moon	Leo – Sun

The first seven names are repeated later in *ApJohn* (II 17,7–8; IV 26,17–19), as rulers over the angels and/or demons ruling parts of the human body (melothesia). In that passage, these must refer to the *planets* as rulers of their respective zodiac signs,⁷⁰ rather than zodiac signs in their own right. Possibly this is why Kain is called the sun in the earlier list (see Table 5.4), so that the subsequent repetition will encompass all seven planets (including luminaries).⁷¹

In addition to the Nag Hammadi texts, the *Gospel of Judas* gives the names of five angels corresponding to the first names in the other books: ‘The first / is [Athō]th who is /called excellent. The /[second] is Harmathōth who /is [---]. The /[third] is Galila. The /fourth is Iobēl. The /fifth is Adōnaios. These /are the

70 See J. F. Quack, ‘Dekane und Gliedervergottung. Altägyptische Traditionen im Apokryphon Johannis’, *JbAC* 38 (1995): 97–122, here 103.

71 A justification for Kain as Sun may lie in the Babylonian tradition, transferred to the Greeks, where Saturn can be ‘the star of the Sun’, the ‘night sun’ or the ‘black sun’: see U. Koch-Westenholz, *Mesopotamian Astrology: An Introduction to Babylonian and Assyrian Celestial Divination* (Copenhagen: Museum Tusulanum Press, 1995), 122–24. For further discussion, with ancient Greek, Babylonian and modern sources, see Beck, *Planetary Gods and Planetary Orders*, 86–88.

five who ruled over /the underworld and the first over /Chaos.⁷² DeConick's plausible reconstruction⁷³ makes this list fall perfectly into line with the similar lists in *ApJohn* and the *Holy Book*.

Andrew Welburn, in a seminal article on this topic, has done the difficult preliminary work of aligning the names of the *Exousiai* with the zodiac signs,⁷⁴ starting by assuming that 'Hermas' must stand for a Mercury-ruled sign. If so, Hermas must be either Virgo or Gemini.⁷⁵ He chooses Virgo, and then goes in zodiacal order, assigning the archon above to Leo, and ending with Cancer and the Moon. His assignment has the virtue of explaining the duplication of some names, and ingeniously recognising that the Saturn-ruled signs, Capricorn and Aquarius, correlate to Cain and Abel.⁷⁶ But he admits that Iaoth/Athoth, which he assigns to Leo (whose house-lord is the Sun) is usually the archon of the

72 TC 52,4 πωθ vac ρπ /5 [... ω?]θ vac πετεωαγν vac ογ /6 [τε ε]ροϋ χε πεχ̄c : πη vac ε̄ε /7 [cna]γ πε ε̄αρηαθωθ ε vac τε /8 [πβαλ ηκ]φ[ε]τ πε : ημε vac ε : /9 [ωοη̄ητ] πε γαλιλα : πμεε /10 ρτορρ πε ιωββλ : πμεε /11 †ογ [π]ε ε̄αδωναιος ηαιε /12 ηε π†[ο]γ ηταγρερο εχη /13 αηηη[ε] αγω ηωορπ εχη /14 πεχαο[ε]. My translation drawing on A. D. DeConick, *The Thirteenth Apostle: What the Gospel of Judas Really Says* (London: Continuum, 2007), 90 and Meyer, ed., *Nag Hammadi Scriptures*, 767. Coptic text from L. Jenott, *The Gospel of Judas: Coptic Text, Translation, and Historical Interpretation of the 'Betrayed' Gospel* (Tübingen: Mohr Siebeck, 2011), 174 (but using DeConick's suggested emendation in line 5 [see n. 73]).

73 The original translation of the name in line 5 was '[S]eth who is called Christ', in R. Kasser, M. Meyer, and G. Wurst, eds., *The Gospel of Judas from Codex Tchacos* (Washington, D.C.: National Geographic Society, 2006), 38. In Meyer, ed., *Nag Hammadi Scriptures*, 767 and R. Kasser and G. Wurst, eds., *The Gospel of Judas together with the Letter of Peter to Philip, James, and a Book of Allogenes from Codex Tchacos: Critical Edition* (Washington, D.C.: National Geographic Society, 2007), 223, there is slight modification of '[S]eth' to '[Se]th' and (only in the critical edition) 'Christ' to "the Christ". The second edition of the English translation, R. Kasser, M. Meyer, and G. Wurst, eds., *The Gospel of Judas, Second Edition* (Washington, D.C.: National Geographic Society, 2008), 47, further modifies the translation to '[(?e]th', but suggests 'Seth' in the accompanying note. However, DeConick discerns the remains of the letter before the visible θ as an ω and takes the abbreviation χ̄c as χρηστός—'excellent', thus proposing the translation '[Ath]oth, the one who is called the "Good One"' (DeConick, *The Thirteenth Apostle: What the Gospel of Judas Really Says*, 90). See her argument both in *The Thirteenth Apostle*, 120–21 and in eadem, 'Apostles as Archons', here 259–60. For the abbreviation χ̄c and its interpretation, see B. Layton, *Coptic in 20 Lessons: Introduction to Sahidic Coptic with Exercises and Vocabularies* (Leuven/Paris/Dudley, MA: Peeters, 2007), 10 (§17).

74 Welburn, 'Identity', 248–54.

75 Ibid., 250.

76 Ibid., 250, 253.

Moon. He also admits that Belias 'has lordship over the other demons',⁷⁷ which would suggest the Sun, not the Moon, as ruler.

Others have followed Welburn's suggestion here, mostly without criticism.⁷⁸ But the problem of Athoth/Iaoth corresponding to Leo remains. As Griffiths notes, Thoth and the Moon have long been associated in Egypt.⁷⁹ Pleše, who cited Griffiths' remark, even adds support for Athoth/Iaoth being a combination of the Egyptian word for moon, *i'ḥ* (Old Coptic ⲓϠ, Sahidic Coptic ⲟⲟ or ⲟϠ) and Thoth, but still reiterates Welburn's assignments.⁸⁰ (Černý, Kahle and Parker report the word ⲉϠ for 'Moon' in line 135 of 'The Old Coptic Horoscope'.⁸¹) DeConick matter-of-factly speaks of the Moon as associated with the archon Athoth.⁸² One version of *ApJohn* associates Iaoth with *pronoia* (BG 43,11–13); we have seen (Chapter 1) that *pronoia* is a function of the Moon in Vettius Valens (1, 1.47).⁸³ Certainly the application of planets or zodiac signs to specific archons, angels or authorities is fraught with confusion given the incompatibility of texts. But the order of the list of the twelve authorities across the various recensions of *ApJohn* and the *Holy Book*, and the five of the *Gospel of Judas*, is remarkably stable, with only minor variations of order in Cain and Abel and in the spelling of names).⁸⁴ Thus I am reluctant to tamper

77 Ibid., 254. For the name 'Beliar' or 'Belial' in OT and apocryphal literature, esp. as a supreme ruler, see R. M. Grant, 'Les êtres intermédiaires dans le judaïsme tardif', in *Le origini dello Gnosticismo. Colloquio di Messina 13–18 aprile 1966*, ed. Ugo Bianchi (Leiden: E. J. Brill, 1967), here 145 and 152: '... le nom Bélias, une forme variante de Béliar que nous trouvons dans l' *Apocryphon Johannis*. Bélias, à son tour, suggère Satan et aussi Saël, probablement identique à Semiel ou Sammaël, selon l' *Ascension d'Esaië* un ange mauvais qui suit Béliar.' See also van der Toorn, Becking and van der Horst, eds, *DDD*, s.v. 'Belial'; esp. 170, in pseudepigraphic literature as Beliar, possibly a pun on 'the Devil's name as "lightness" (*bēlī 'ōr*)...'.
78 Denzey Lewis, *Cosmology and Fate*, 173–74; Pleše, *Poetics*, 187–90 (with slight changes).
79 T. Onuki, *Gnosis und Stoa. Eine Untersuchung zum Apokryphon des Johannes* (Göttingen: Universitätsverlag Freiburg Schweiz/Vandenhoeck & Ruprecht, 1989), 63 n. 14 and Quack, 'Dekane und Gliedervergottung', 103, n. 38 also mention Welburn's commentary.
80 In Plutarch, *Plutarch's de Iside et Osiride*, 458.
81 Pleše, *Poetics*, 190 continuing n. 43; 187 and 189.
82 J. Černý, P. E. Kahle, and R. A. Parker, 'The Old Coptic Horoscope', *JEA* 43 (1957): 86–100, here 94 and 98.
83 DeConick, 'Apostles as Archons', 248.
84 See the discussions of *pronoia* in Denzey Lewis, *Cosmology and Fate*, 46–50; and of the archon lists esp. regarding Iaoth, *pronoia* and the Moon in van den Broek, *Studies in Gnosticism and Alexandrian Christianity*, 68–70.
85 Pace DeConick, 'Apostles as Archons', 259, who says their sequence and spelling are not stable.

with the list's order as Pleše does when he proposes that Iao be relocated to last place or replace Iaoth in the list.⁸⁵

My alternative proposal, beginning the series not with Leo but with Cancer, takes care of the problem with Athoth. Welburn considers this implausible;⁸⁶ but the sign of Cancer begins at the longest day of the year (the heliacal rising of Sirius, so important in Egyptian cosmology, also takes place in Cancer); Cancer is also the Ascendant of the *Thema mundi*, the astrological birthday of the world. The Moon's archon, Athoth/Iaoth, aligns properly with Cancer. Then, instead of zodiacal order through the signs, my suggested scheme follows their diurnal order:⁸⁷ the next sign would be Gemini, again ruled by Mercury and corresponding to the archon Hermas. Moving through the zodiac in reverse, all of the planetary assignments match with the zodiacal ones (just as in Welburn's system). (See Table 5.4.) Diurnal order, the apparent path of the Sun's daily cycle, emphasises the importance of the Sun, while beginning with Cancer emphasises the importance of the Moon. Apparently it did not occur to Welburn to place the signs in diurnal order, so he was left with the difficulty of explaining why Iaoth/Athoth was linked to the Sun/Leo, and Belias then had to be given to the Moon/Cancer. My adjustment eliminates this problem. In addition, the list in the *Gospel of Judas*, which says that the first five angels rule over the underworld, would correspond with my scheme, where the first five angels correspond to Cancer, Gemini, Taurus, Aries and Pisces; Aquarius,

85 Pleše, *Poetics*, 188–89.

86 Welburn, 'Identity', 249: '... to begin the sequence at Cancer is so unusual a procedure that it would have to be explained as a "blind" for the uninitiated ...'

87 There is contemporary evidence of zodiacs being depicted both in zodiacal and diurnal order; see my discussion in Chapter 3, 1.4, on the Nabataean monument to Tyche at Khirbet et-Tannur (early 2nd century CE); also N. Glueck, 'The Nabataean Temple of Khirbet et-Tannûr', 13–14; J. Lindsay, *Origins of Astrology* (London: Frederick Muller, 1971), 378; R. Wenning, 'The Message of the Khirbat at-Tannûr Reliefs', *Studies in the History and Archaeology of Jordan* 10 (2009): 577–84; J. S. McKenzie et al., *The Nabataean Temple at Khirbet et-Tannur*, 1, 208 fig. 358, 213–18. On this monument Aries to Virgo go counter-clockwise (zodiacal order) from the top left half of the zodiacal circle, while Libra to Pisces run clockwise (diurnal order) down the top right half. The zodiacs (2nd century CE) in the tomb at Athribis run clockwise in two columns: W. M. F. Petrie, J. H. Walker, and E. B. Knobel, *Athribis* (London: School of Archaeology in Egypt, University College and Bernard Quaritch, 1908), 12–13, 23–24, plates 36 and 37; also Neugebauer and Parker, *EAT*, III, 205, where Neugebauer and Parker mention other Egyptian zodiacs which run in both directions. Possibly this diurnal order, given the evidence outlined here, has antecedents in Egypt. Other Egyptian antecedents for *ApJohn* have been outlined, e.g., in Quack, 'Dekane und Gliedervergottung'. A Mithraic connection to this order is also possible; see below, 3.2.

Pisces, Aries, Taurus, Gemini and Cancer are called the lunar (i.e. night-time, underworld) houses of the planets.⁸⁸

In any case (assuming that these twelve do correspond in general to the zodiac), the angels-acons-*exousiai*, as zodiacal rulers, thus gain control over the planetary archons, and reinforce the hierarchy which places angels over demons in the Gnostic tradition. This system could not have been created without the astrological dignities of house rulership already in place. Again, astrology's system engenders a framework for Gnostic doctrine and intertwines with it. From the Gnostic side, it may be that Gnostic insistence on the planetary spheres as material, subject to *heimarmenē*, reinforces the incessant criticism of astrology as a fatalistic practice.

2.3 Hierarchies in the Pistis Sophia

The *Pistis Sophia* is undeniably influenced, even suffused, by the astrological⁸⁹ and daimonic world view. However, unlike the archons of other Gnostic texts, in this one archons who embrace the light are permitted to escape the dark and material world in which other rebelling archons still remain.⁹⁰ The latter produce multitudes of aeons, archons, archangels, angels, ministers and decans, all occupying the sphere of *Heimarmenē* (material fate).⁹¹ But Jeu sets

88 Ptolemy, *Tetrabiblos*, 1, 18.3 (Hübner, 58.887–888). Though at this point (253–54) he does not cite Giverson, who originated this idea, Welburn refers to 'the seven signs from Aries to Libra' lying above 'the intersection of the ecliptic and the equator', and 'the remaining ones, from Scorpio to Pisces, below.' He means Giverson's suggestion that the signs Aries and Libra were the equinoctial signs at the time of Hipparchus, and therefore were 'above' with the other five signs between them also 'above'. I know of no attribution like this in extant astrological texts. Ptolemy's division of solar and lunar zodiacal semicircles comes the closest to this, I suppose; but there are naturally *six* signs in each semicircle. Denzey Lewis, *Cosmology and Fate*, 174, repeats Welburn's (surely erroneous) attribution as 'a traditional division in astrology.' Z. Pleše, 'Fate, Providence and Astrology in Gnosticism (1): The *Apocryphon of John*', *MHNH* 7 (2007): 237–68, here 245–48, has attempted to make sense of this 'seven-five' division by various methods, none of which are entirely successful.

89 For aspects of astrology in the *Pistis Sophia*, see Lancellotti, 'Gli gnostici e il cielo', 86–90; van der Vliet, 'Fate, Magic and Astrology in *Pistis Sophia*'; and von Lieven, 'Gnosis and Astrology'.

90 As von Lieven, 'Gnosis and Astrology' 225 and fig. 1 makes clear, the light and dark sides are based on the day and night houses of the planets: from Leo to Capricorn are day (solar) houses, while Cancer to Aquarius are night (lunar) houses. Thus the zodiac, as well as the planet Jupiter, is not entirely condemned as evil in *PS*.

91 *PS* IV, 136 (Schmidt/MacDermont, 355.13–16). Von Lieven ('Gnosis and Astrology', 224) has proposed that the antecedents of the various archangels and angels are messenger demons associated with Egyptian decan practice.

‘five other great archons to rule over the 360 and over all the archons which are bound, which are called in the whole world of mankind by these names. The first is called Cronos, the second Ares, the third Hermes, the fourth Aphrodite, the fifth Zeus.’⁹² Zeus is endowed with goodness, given power from Little Sabaoth the Good, and guides the archons in the aeons out of their wickedness.⁹³ The astrological component is obvious both in the mention of 360—the degrees of the zodiac—and the five archons who rule over the 360—in astrology, the five non-luminary planets who rule certain numbers of degrees (called bounds or terms) in each sign. The 360 rulers may correspond to the doctrine of *monomoiria* in astrology, which assigns one planet to each degree of the zodiacal circle.⁹⁴ Each aeon is a zodiac sign, as we saw in the *Apocryphon of John* and *Great Invisible Spirit*.

A daimonic hierarchy exists as well, linked to the decans and showing clear parallels to the way decans are described in the Hermetic texts.⁹⁵ Jesus says:

I will fulfil you in all the mysteries of the light, and every *gnosis* . . . from all the gods [ἄνωγε] to the demons [ἄδαιμόνια]; from all the lords [ἄρχοι] to the decans [ἄδεκανοί]; from all the authorities [ἄεξουσία] to the ministers [ἄλιτογυργός]; from the creation of men to (that of) beasts. . . .⁹⁶

The parallel constructions used imply contrasts between gods and daimons, lords and decans, authorities and ministers, men and beasts. The gods, lords and authorities are higher, respectively, than the daimons, decans and ministers; the text thus suggests that the lower entities must follow the will of

92 IV, 136 (Schmidt/MacDermot, 356.8–14): ‘... ἄνωγε ἄνωσ ἄρχων ἐγάρχι ἐξἄνω πᾶντῶε σε· ἀγῶ ἐξἄνω ἄρχων τήρω ἐτήρη· καὶ νετεωαγμογε ερωογ ἄνω πκοσμοσ τήρω ἄνωπῶε ἄνωπῶε ἄνωπῶε περογετ· εωαγμογε ερωο γε κρονοσ· πμερσναγ γε ἀρησ· πμερωοῶνωτ γε ρερησ· πμερωτοογ γε ταφροδιτη· πμερωτογ γε πζεγσ·’ MacDermot’s translation. Similar reference in Welburn, ‘Identity’, 242.

93 IV, 137 (Schmidt/MacDermot, 357.3–9).

94 See, e.g. Paulus, chs 5 and 32; Olympiodorus, ch. 34.

95 See Chapter 6, 2.1, 210–11 and 3.3, 220–22 for discussions of the *Hermetica* and the decans. W. Gundel, *Dekane und Dekansterbilder: Ein Beitrag zur Geschichte der Sternbilder der Kulturvölker* (Glückstadt/Hamburg: J. J. Augustin, 1936), 350–52 translates material on decans in the *Pistis Sophia*.

96 I, 45, 8 (Schmidt/MacDermot, translation 77, Coptic 76.7–8, 11–14): ‘ἄνωδεκ-τηγῶνω εβολ ἄνωστῆριον νῆν ἄνω ποροεῖν· ἀγῶ ἄνω γνωσῖσ νῆν . . . ἄνω ἄνωγε τήρω· ὡα ἄδαιμόνια· ἄνω ἄρχοι τήρω· ὡα ἄδεκανοί· ἄνω ἄεξουσία τήρω· ὡα ἄλιτογυργός· ἄνω πταμιο ἄρωε· ὡα ἄνωπῶε·’ MacDermot’s translation, slightly modified. (Other references to decans in conjunction with ministers at I, 1; I, 8 and IV, 136.)

the higher ones. This is consistent with doctrine from other venues like the *Hermetica* and decan texts. Other contrasts and parallels continue in Book II, where we see: ‘And that mystery [of the Ineffable] knows why the daimons [ἸΔΔΑΙΜΟΝΙΟΝ] came into existence, and why mankind.⁹⁷ . . . And that mystery knows why the ministers [ἸΛΕΙΤΟΥΡΓΟΣ] came into existence, and why the decans [ἸΔΕΚΑΝΟΣ].⁹⁸

The presentation of daimons and decans as subservient in this hierarchy suggests a daimonic component for decans (we shall see evidence of this in Chapter 6). The decans, like daimons (*as* daimons?), have some power over souls as well: ‘And I will say to you the name of all the decans which act upon the soul in the bodies of the soul in the world, and I will say to you in what manner the souls are acted upon.’⁹⁹ The concept of decans acting upon souls seems very consistent with ideas of their influence on humans in late Egyptian and Greco-Roman culture; it also coincides, interestingly, with Plato’s description of daimons who guide souls in the Myth of Er.¹⁰⁰ In any case, the *Pistis Sophia* shows a prevailing interest in and use of both astrology and daimons in Late Antiquity. The clearly astral decans within its myriad hierarchies may reinforce, or at least parallel, the use of decans within astrological practice. In Gnosticism, daimons and decans operate within the *heimarmenē* sphere, and are a part of the unfortunate fate of the material world; Mithraism, as we shall see, views the world and heavens in a different way.

3 Daimons and Astrology in Mithraism

In the last thirty-five years, a number of books and articles on Mithraism have emphasised its reliance on astrological schemas.¹⁰¹ We have seen theories

97 II, 93 (Schmidt/MacDermot, 213.12–14): ‘ἄε πηγύστηριον ἐτῆμαγ ἦτοϋ πετσοϋγι ἄε ἐτβε οϋ ἀγϋωπε ἦσι ἸΔΔΑΙΜΟΝΙΟΝ· ἀγϋω ἐτβε οϋ ἀσϋωπε ἦσι τῆνῆτρωνε’. MacDermot’s translation.

98 II, 93 (Schmidt/McDermot, 215.3–5): ‘ἀγϋω πηγύστηριον ἐτῆμαγ ἦτοϋ πετσοϋγι ἄε ἐτβε οϋ ἀγϋωπε ἦσι ἸΛΕΙΤΟΥΡΓΟΣ· ἀγϋω ἐτβε οϋ ἀγϋωπε ἦσι ἸΔΕΚΑΝΟΣ’. MacDermot’s translation.

99 III, 131 (Schmidt/MacDermot, 336. 4–7): ‘ἀγϋω †ἸΔΔΩ ἐρωτῆν Ἰπραν ἸἸΔΕΚΑΝΟΣ τηροϋ ναἰ ἐϋαγῖρῶβ ἐτεϋγχι ρραἰ ἸἸ Ἰσῶμα Ἰτεϋγχι ἸἸ πκοςμος ἀγϋω †ἸΔΔΩ ἐρωτῆν ἄε ἐγῖρῶβ ἐνεϋγχοοϋε Ἰαϋ Ἰρε’. MacDermot’s translation.

100 For other connections of Plato to the *Pistis Sophia*, see van der Vliet, ‘Fate, Magic and Astrology in Pistis Sophia’, 530 and nn. 28–30.

101 See n. 10; see also, for the emphasis on astrology, R. Beck, ‘Mithraism Since Franz Cumont’, in *ANRW*, vol. II.17.4, ed. Wolfgang Haase (Berlin: Walter de Gruyter & Co., 1984), esp. 2007; H. J. W. Drijvers in *DDD*, s.v. Mithras, 579; Luther Martin, preface to Beck, *Beck on Mithraism*,

of Gnostic borrowing from Mithraic practices earlier in this chapter, though the subsequent employment of the borrowed material is theologically different.¹⁰² As with the Gnostics, Mithraic cosmology incorporates both planets and zodiac, but for the Mithraists the planets are ruled not by evil daimonic archons, but rather act as tutelary powers who guide the soul (initiate) in its ascent. The astrologically significant amount of seven, and reliance on the zodiac, also appear, with the Mithraists' seven grades of initiation, seven spheres and seven gates,¹⁰³ and the incorporation of the zodiac signs into their planetary orders and on their monuments.

In contrast with most forms of Gnosticism, the Mithraic system posits not evil, but good being accomplished from its astrological planetary gods and zodiac. Mithraism posits no evil in matter. The soul ascends is through grades not designed to shake off evil materiality, but to allow the initiate to benefit from the divine planets as he progresses through each grade. Given previous scholarship,¹⁰⁴ I shall not provide exhaustive explanations of the Mithraic system and its reliance on astrological concepts. My interest is in the contrast between Gnostic and Mithraic interpretations of the sky, gods and daimons, and how these affected astrological theory and practice. In particular, I shall explore an alternative *thema mundi* (birthchart of the world) which may have some dependence on zodiac signs important in Mithraic doctrine.

3.1 *Astrologers and the Development of Mithraism*

Astrologers provide some testimony on the Mithraic cult. In *On the Cave of the Nymphs*, Porphyry connects the cave and its entrances in Cancer and Capricorn with Mithras,¹⁰⁵ and he calls Mithras 'the demiurge and master of birth'.¹⁰⁶ The gates are also associated with the Sun and the Moon (since the Sun reaches its northernmost point in Cancer, the sign of the Moon), and with Saturn (ruler of Capricorn). Mithras, says Porphyry, is situated near the equinoxes in order

xiii–xiv; and Beck himself in the same publication, 'Mithraism after "Mithraism Since Franz Cumont"', 3–23. Also D. Ulansey, *The Origins of the Mithraic Mysteries: Cosmology and Salvation in the Ancient World* (Oxford: Oxford University Press, 1991 (rev.)).

102 Connections between the two religions had been earlier addressed by U. Bianchi, 'Mithraism and Gnosticism', in *Mithraic Studies: Proceedings of the First International Congress of Mithraic Studies*, 2 vols., vol. II, ed. John R. Hinnells (Manchester: Rowman and Littlefield, 1975).

103 For more on the importance of the number seven in Mithraism, and its relationship to the planets, see Beck, *Planetary Gods and Planetary Orders*, 12 and n. 27, 13.

104 See nn. 10 and 101.

105 *De antro*, 20–21.

106 *De antro*, 24 (Seminar Classics 609, 24.11–12): δημιουργός δὲ ὦν ὁ Μίθρας καὶ γενέσεως δεσπότης...

to be midway between the solstices and rule over them. The sword he carries is the sword of Ares (ruling Aries), and he rides a bull (Taurus), the symbol of generation and fertility in its ruler, Venus.¹⁰⁷ So he is actually lord of both (fertile) life and (violent) death (Venus vs. Mars, Cancer vs. Capricorn).¹⁰⁸

Another connection between Mithraism and astrologers comes from a theory proposed by Roger Beck about the origins of the Mithraic cult in the west.¹⁰⁹ He suggests that the astrologer T. Claudius Balbillus was an important force in the development of the Mithraic cult and its introduction into Rome. This theory, plausibly supported by Beck's evidence,¹¹⁰ would account for the astrological emphasis in Mithraism, as well as help to explain its planets as gods and helpers—in contrast to the Gnostic planets as demons and hinderers, even though the two systems have some similarities of structure.¹¹¹ Since astrology historically, either as a valid form of divination or as a causal explanation of events on earth, does not see the planets as intrinsically evil,¹¹² its incorporation within Mithraic cosmology, especially if influenced by an astrologer, must stress the fundamental goodness of planets and signs.

In addition, Beck suggests that the astrologer Antiochus of Athens is the grandson (on his mother's side) of Balbillus,¹¹³ thereby continuing the astrological dynasty started by Thrasyllus, Balbillus's father.

107 *De antro*, 24 (Seminar Classics 609, 24.10–11): διὸ κριοῦ μὲν φέρει Ἀρηίου ζφδίου τὴν μάχαιραν, ἐποχεῖται δὲ ταύρω, Ἀφροδίτης δὲ καὶ ὁ ταύρος.

108 Roger Beck discusses the Mithraic dimensions in *De antro* in Beck, *Planetary Gods and Planetary Orders*, 93–96; he proposes an emendation to this text in R. Beck, 'The Seat of Mithras at the Equinoxes: Porphyry, *De Antro Nympharum* 24', *Journal of Mithraic Studies* 2 (1977): 95–98 (the emendation, in my view, does not change the significance of Porphyry's mentioning Ares and Aphrodite, though Beck maintains [97–98] they are now just 'logical links' for Porphyry to connect Mithras to the equinoctial signs. But Porphyry has emphasised the Sun, Moon and Saturn for the solstices, so why not a similar emphasis on Ares and Aphrodite for the equinoxes?).

109 R. Beck, 'The Mysteries of Mithras: A New Account of Their Genesis', *JRS* 88 (1998): 115–28. See also idem, *Beck on Mithraism*, ch. 15, 323–29: 'Whose Astrology? The Imprint of Ti. Claudius Balbillus on the Mithraic Mysteries'.

110 Beck, 'The Mysteries of Mithras', 126–27.

111 See Origen, *Contra Celsum*, VI, 22–31, which deals with Mithraism and Gnostic Christianity. Bianchi, 'Mithraism and Gnosticism', 463–64, discusses this.

112 Since they are gods; obviously, this is a philosophical/religious viewpoint, separate from the theoretical and practical idea of the planets categorised according to their effects on the world, i.e. benefic and malefic planets associated with good and bad effects (but even 'malefic' planets can do good, as 'benefic' planets can do evil, depending on their condition and placement in the chart).

113 Beck, *Religion of the Mithras Cult*, 253–55.

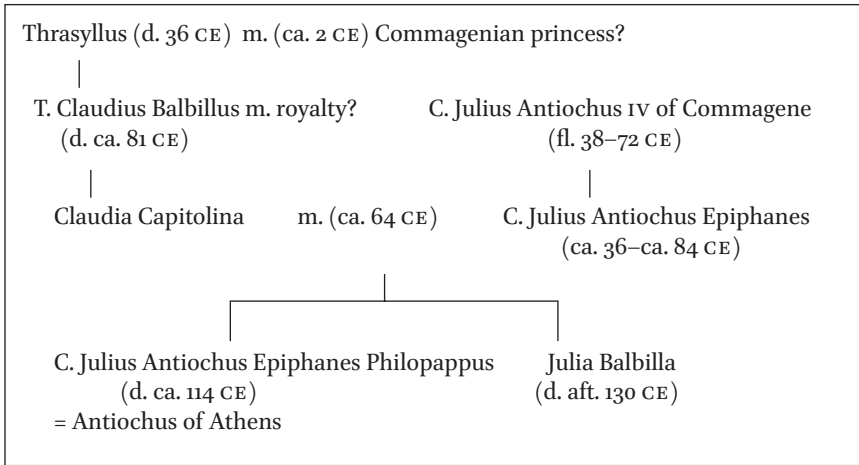

FIGURE 5.1 Beck's proposed genealogy of Antiochus of Athens.¹¹⁴

If Balbillus is a principal in the formation of Mithraic doctrine, and Antiochus the astrologer is the heir of Balbillus and Thrasyllus, then this, in turn, increases the influence of Mithraism on the astrology of the Roman Empire, to say nothing of the influence of astrology on Mithraism, or at least the Empire's Mithraic cult. For our purposes, the concepts of god versus daimon, astrological good and bad daimons, the ascent of the soul through planetary spheres and the importance of the personal daimon in guiding souls on the path of virtue may all become coloured, knowingly or unknowingly, by Mithraism's tenets making the planetary gods stations on the way to salvation. (The systems of astrology, in turn, colour the way Mithraic doctrine is laid out.)

Some of Beck's evidence for Antiochus's Mithraic perspective is supplied by Antiochus's calendar and his descriptions of astrological *apokatastasis*.¹¹⁵ Antiochus's writing on the *thema mundi* may also give evidence of a Mithraic slant. The *thema mundi* is commonly described as a chart for the beginning of the world, and may justify the house-dignities of the planets; but clues in Thrasyllus, Antiochus and Firmicus point to another rationale for this chart.

114 Beck, 'The Mysteries of Mithras', 126–27 and n. 60. For dates, I have used F. H. Cramer, *Astrology in Roman Law and Politics* (Chicago: Ares Publishers, Inc., 1954, repr. 1996), 95; and R. D. Sullivan, 'The Dynasty of Commagene', in *ANRW*, vol. 11.8, ed. Hildegard Temporini and Wolfgang Haase (Berlin/New York: Walter de Gruyter, 1977), here 785–98.

115 Beck, *Religion of the Mithras Cult*, 254–55, citing respectively F. Boll, *Griechische Kalender I. Das Kalendarium des Antiochus* (Heidelberg: Carl Winter's Universitätsbuchhandlung, 1910); and *CCAG* I, 163.15–23.

In addition, Antiochus offers an alternative version of the *thema mundi* with some interesting commentary.

3.2 *Two Themata Mundi and the Nativity of a God*

Aside from later testimony ascribed to Nechepso and Petosiris by Firmicus (*Math.* III, Intro.4), the earliest astrologer in the extant Greek and Latin astrological corpus to mention the *thema mundi*¹¹⁶ is Thrasyllus (cited in a summary of his astrological works): ‘... he [Thrasyllus] goes through the nativity of the cosmos and, having described the chart, he recommends also that the nativity of each person be inspected in relationship to the standard of the nativity of the cosmos.’¹¹⁷ The implication, then, is that house rulership (and perhaps exaltation; see below) is an important measure not only of the chart of the world, but also of the charts of individuals.

Probably the best-known description of the *thema mundi* is found in Firmicus, *Mathesis* III, 1.¹¹⁸

116 For general discussions of the *thema mundi*, including its classical, Indian, Arab and Zoroastrian versions, see E. G. Raffaelli, *L'oroscopo del mondo: Il tema di nascita del mondo e del primo uomo secondo l'astrologia zoroastriana* (Milan: Mimesis, 2001); G. Bezza, *Arcana Mundi: Antologia del pensiero astrologico antico*, 2 vols. (Milan: Rizzoli, 1995), vol. 1, 283–85, 292–93; idem, ‘Sulla tradizione del Thema Mundi’, in *Giovanni Schiaparelli: storico della astronomia e uomo di cultura. Atti del Seminario di studi organizzato dall'Istituto Italiano per l'Africa e l'Oriente e dall'Istituto di Fisica Generale Applicata dell'Università degli Studi di Milano. Milano, 12–13 Maggio 1997, Osservatorio Astronomico di Brera*, ed. Antonio Panaino and Guido Pellegrini (Milan: Mimesis—Istituto italiano per l'Africa e l'Oriente, 1999); Bezza mentions Antiochus's two *themata* but does not address the difference between them (he does discuss the difference between a ‘house’ *thema* and an exaltation *thema*). Quack, ‘Dekane’, Exkurs: Das rechteckige Himmelsbild von Dendera, das Thema Mundi und der erste Teukros-Text, also discusses the *thema mundi* related to the zodiacs in Egyptian iconography and a text of Teucer. Quack first concentrates on the angles of the *thema mundi*, rather than the planets in it. He also discusses the differences between the Firmicus and Paulus *themata*, and mentions Thrasyllus, Antiochus and Vettius Valens; in the 2014 version of this work, he does mention Antiochus's second *thema*, but regards it as unrelated to what he considers to be the Egyptian-derived *thema mundi*.

117 *CCAG* VIII/3, 100.27–30: ... διαλαμβάνει περί τῆς κόσμου γενέσεως καὶ τὸ θεμάτιον διαγράψας τῷ λόγῳ παραίνει πρὸς τὸν κανόνα τῆς τοῦ κόσμου γενέσεως καὶ τὴν καθ' ἕκαστον τῶν ἀνθρώπων γένεσιν ἐπισκοπεῖσθαι.

118 *Mathesis* (KSZ I, 91 = Monat, II, 15). In his descriptions of the zodiac signs in Book 1, Vettius Valens is careful to point out the signs that form the angles and the eleventh place (considered acquisitive) of the world chart (I, 2.1, 14, 37, 51, 57; Pingree, 5, 7, 8, 10). Note that the 11th, place of the Good Daimon, is the only non-angular place so-mentioned.

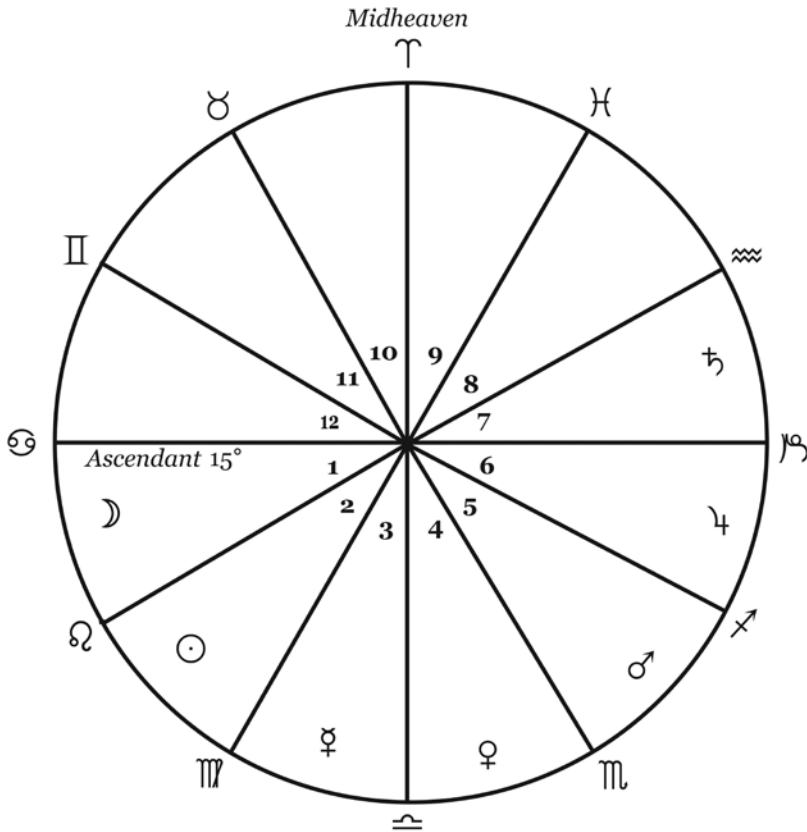

FIGURE 5.2 *Traditional Thema Mundi, as in Firmicus.*

Beginning with Cancer as the Ascendant, it places each planet in a sign of its domicile, moving in zodiacal order around the lower hemisphere of the chart. Thus the planets except for the Moon fall in their 'solar' houses (Ptolemy, *Tetr.* 1, 17), from Leo to Capricorn. Since the Sun is in Leo and falls in the second place, the chart is nocturnal.¹¹⁹

Firmicus says the chart comes from Nechepso and Petosiris;¹²⁰ they received it from Aesculapius and Hanubius (Asclepius and Anubis),¹²¹ who received it

119 Though most *themata mundi* show the Sun in Leo, a variant in Paulus's *Introduction*, ch. 37 (Boer, 99.3–4), has the Sun in Aries 19°, the sign and degree of its exaltation.

120 III, Intro.4 (KSZ, I, 91.3–7 = Monat, II, 15): Quare illi divini viri atque omni admiratione digni Petosiris, Nechepso, quorum prudentia ad ipsa secreta divinitatis accessit, etiam mundi genituram divino nobis scientiae magisterio tradiderunt. . .

121 Though Obbink accepts this as a *testimonium* of the 1st century CE astrologer Anubio (Anubio, *Carmen Astrologicum Elegiacum*, ed. Dirk Obbink, (Munich/Leipzig: K. G. Saur,

from Hermes (III, 1.1). Clearly he thinks its ancestry is Egyptian. Not only is this the chart of the world, it aims to show that humans are ‘formed in accordance with the nature of the world and in likeness with those same principles by which the world itself is ruled and comprised’ (III, Intro.4).¹²² For Firmicus, the chart is mythic and symbolic.¹²³ He may have been familiar with Thrasyllus’s work on the *thema mundi*, for he also says ‘...so that the astrologers could follow an example in the birthcharts of humans, the divine men, with skilled reasoning, therefore conceived this [chart] as if it were the birthchart of the world.’¹²⁴ From this and the comment at III, Intro.4, one might intimate that this chart, with the planets in the signs of their rulerships, could also represent the chart of someone ‘divine’. In Antiochus, transformation from *thema mundi* to *thema dei* is explicitly made: we find that the ‘nativity of the cosmos’ has become the nativity of a god:

...he [Antiochus] says, according to the opinion of the ancients, that a nativity of a god comes to be when the 7 stars happen to be in their own houses, as a mortal nativity would not be so fortunate. Example: when Cancer marks the hour, holding the Moon; the Sun follows, occupying Leo, then Hermes in Virgo, after which Aphrodite in Libra and Ares in Scorpio; Zeus in Sagittarius and Kronos in Capricorn; or otherwise, when Aquarius marking the hour holds Kronos, Pisces follows with Zeus, then Aries holding Ares and Taurus Aphrodite; Gemini Hermes, Cancer the Moon and Leo the Sun; but he says such natiivities are worthy of more divine portions,¹²⁵ and those which come close to these [divine natiivities]

2006), see T3, p. 3), see the persuasive case against this, and arguing for a reference to the god Anubis, in S. Heilen, ‘Anubio Reconsidered’, *Aestimatio* 7 (2010): 127–92, here 140–41.

122 (KSZ, I, 91.7–9 = Monat, II, 15): ut ostenderent atque monstrarent hominem ad naturam mundi similitudinemque formatum isdem principiis, quibus ipse mundus regitur et continetur...

123 ‘This was not the birthchart of the world; for the world did not have a certain day of birth.’ (III, 1.9 [KSZ, I, 93.21–22 = Monat, II, 17]: Non fuit ista genitura mundi; nec enim mundus certum diem habuit ortus sui....) ‘... the birthchart of the world was put together with divine interpretation by conjecture....’ (III, 1.15 [KSZ I, 95.24–25 = Monat, II, 20]:... genitura mundi divina coniecturae interpretatione composita est....)

124 III, 1.10 (KSZ I, 94.8–10 = Monat, II, 18): Sed ut esset, quod mathematici in genituris hominum sequerentur exemplum, ideo hanc quasi genituram mundi divini viri prudenti ratione finxerunt. (Similar at III, 1.15, KSZ I, 95.27–28 [= Monat, II, 20]:... ut hoc esset, quod in genituris hominum sequeremur exemplum.

125 Possibly a play on words using the meaning of *moira* both as a portion or lot, and as an astrological degree. For the expression *θειοτέρα μοίρα*, see F. Cumont, ‘Antiochus d’Athènes et Porphyre’, *L’Annuaire de l’Institut de Philologie et d’Histoire Orientales* 2 (Mélanges Bidez)

share more in common [with them], but those which are different from them have little in common, and those with nothing come to misfortune in the end. And in their own exaltations the stars are productive and signify an illustrious nativity, even if not [exactly] alike.¹²⁶

It is an astonishing development to see the *thema mundi* metamorphose into the chart of an immortal. (There can be no doubt that this is what Antiochus intends, since the positions in his first chart are identical to those of the usual *thema mundi*.) Not only that, but the alternative chart he offers is also astounding in its implications.

Instead of Cancer rising, this chart has Aquarius rising. In Porphyry's *On the Cave of the Nymphs*, we find: 'For the Egyptians, the beginning of the year is not Aquarius, as it is for the Romans, but Cancer.'¹²⁷ I have found no other text which says the Roman new year begins in Aquarius;¹²⁸ is this connected with Mithraism in some way, and could this be one reason why Antiochus chose an Aquarius Ascendant for his alternative chart?¹²⁹ Antiochus may merely be proposing an additional chart based on the planetary rulers of the other signs, but

(1933): 135–56, here 146, n. 3, where he discusses this paragraph and cites this expression in Philo, *Legatio ad Gaium*, 76 (the context is similar in that it discusses someone considered superior to mere mortals being given a 'more divine portion').

126 *Introduction*, Book II, 1, *CCAG VIII*/3, 118.29–119.12: . . . θεοῦ γένεσιν καὶ κατὰ τὴν τῶν παλαιῶν δόξαν γίνεσθαι λέγει, ἐν ἧ οἱ ζ' ἀστέρες ἐν ἰδίῳ οἴκοις ἔτυχον ὄντες, ὡς οὐκ ἂν τοσοῦτον θνητῆς γενέσεως εὐτυχησάσης. ὑπόδειγμα· οἶον ὠροσκοπεῖ μὲν Καρκίνος ἔχων τὴν Σελήνην, ἀκολουθεῖ δὲ Ἥλιος Λέοντι ἐπέχων, εἶτα Ἐρμῆς ἐν Παρθένῳ, μεθ' ὧν ἐν Ζυγῷ Ἀφροδίτη καὶ Ἄρης ἐν Σκορπίῳ, ἐν Τοξότη καὶ Ζεὺς καὶ Κρόνος ἐν Αἰγόκερῳ, ἢ πάλιν ὠροσκοποῦντος Ὑδροχόου ἔχοντος Κρόνον, ἐπομένων δὲ Ἰχθύων μετὰ Διός, εἶτα Κριοῦ τὸν Ἄρην ἔχοντος καὶ Ταύρου μὲν τὴν Ἀφροδίτην, Διδύμων δὲ τὸν Ἐρμῆν καὶ Καρκίνου τὴν Σελήνην καὶ Λέοντος τὸν Ἥλιον· ἀλλὰ τὰς μὲν τοιαύτας γενέσεις θειοτέρας ἀξιόσθαι μοίρας φησὶν, ἐγγίζειν δὲ ταύταις ὅσαι κατὰ πλείονα κοινωνοῦσιν, τὰς δὲ κατ' ὀλίγα δίστασθαι, τὰς δὲ κατὰ μηδὲν εἰς ἔσχατον δυστυχίας ἦκειν· καὶ ἐν τοῖς ἰδίῳ δὲ ὑψώμασιν τοὺς ἀστέρας χρηματίζοντας λαμπρὰν τὴν γένεσιν, εἰ καὶ μὴ ὁμοίαν, σημαίνειν.

127 *De antro* 24 (Seminar Classics 609, 23.33–24.1): Αἰγυπτίοις δὲ ἀρχὴ ἔτους οὐχ ὁ ὕδροχόος, ὡς Ῥωμαίοις, ἀλλὰ καρκίνος. . . .

128 Julius Caesar introduced the solar calendar beginning on 1 January, 45 BCE. The Roman civil year began on 1 January, but zodiacally speaking this date is in the sign of Capricorn, not Aquarius. The Egyptian new year began with the heliacal rising of Sirius in Cancer. I thank Attilio Mastrocinque for spurring me to clarify this dating question.

129 There is no available evidence to answer this question. Porphyry may have mistakenly written Aquarius for Capricorn, or he may have considered January the 'Aquarius month' because the sign begins in January. But note that in his astrological writings, Porphyry often borrows heavily from Antiochus.

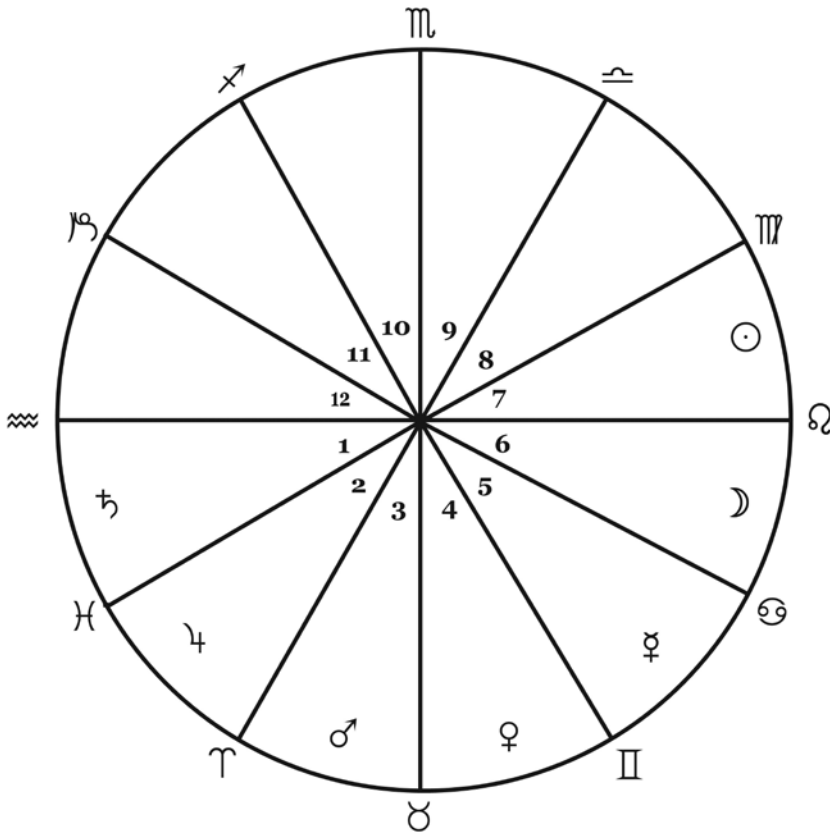

FIGURE 5.3 *Antiochus's alternative Thema Mundi.*

there may be another reason as well. This chart, with an Aquarius Ascendant and Saturn in the first place, could show a Mithraic connection between Saturn, representing the highest grade in Mithraism, and the Ascendant signifying the life (i.e., the coming into existence) of the person.¹³⁰ Thus some 'divine' people are born having descended directly from the highest sphere, Saturn's (rather than the usual *thema mundi* with its Cancer Ascendant, ruled by the lowest sphere of the Moon).

The Aquarius Ascendant compels other striking changes: first, because the Sun remains in its own house, Leo, the chart becomes diurnal. Astrologically, this emphasises the importance of the Sun, even though it falls in the seventh

¹³⁰ For a discussion of the importance of Saturn in relation to the birth of Mithras, see M. J. Vermaseren, 'The Miraculous Birth of Mithras', *Mnemosyne* 4, no. 3/4 (1951): 285–301, here 294–99.

(setting) place; it further emphasises the link between Saturn and the Sun through the horizontal axis of the chart. Second, though still in the lower hemisphere, the planets now are in the signs of their lunar houses (Aquarius through Cancer; Ptolemy, *Tetr.* 1, 17). Third, Taurus now falls in the fourth place, the foundation of the chart, and Taurus is the symbol *par excellence* of Mithras. Fourth, instead of tropical angles, we have fixed ones, and these correlate much better with Mithraic doctrine which emphasises fixed signs.¹³¹ Fifth, Mars and Venus now fall in Aries and Taurus respectively, and we have seen above (3.1) that Mithras bears the sword of Ares (ruler of Aries) and rides on a bull (Taurus); these planetary placements thus conform more to Mithraic mythology.

A further, albeit speculative, conclusion may be drawn from this alternate *thema dei*: because Antiochus has designated these charts as those of ‘gods’, this alternative chart could be his creation of a symbolic chart for the divine Mithras¹³² (though Antiochus never identifies it as such). As an ‘example’ of a god’s chart, it provides a template to which an initiate moving towards the completion of the soul’s ascent could aspire.¹³³ Some support for this hypoth-

131 The connection of Taurus the bull to Mithraism is obvious, as is Leo the lion; but Scorpio and Aquarius also have some prominence. See Beck, *Planetary Gods and Planetary Orders*, 19–20, 22, 25–28, 35–37, 42.

132 Regardless of whatever the ‘actual’ chart of Mithras might be.

133 Here we point out the Indian and Iranian (Zoroastrian) traditions of exaltation *themata* designating superior or even divine individuals. Zoroastrian tradition has a *thema mundi* of planets in exaltation used as the birthchart of a ‘first man’, Gayomart: see D. N. MacKenzie, ‘Zoroastrian Astrology in the “Bundahišn”’, *Bulletin of the School of Oriental and African Studies, University of London* 27, no. 3 (1964): 511–29, here 522 and n. 54, 528–29 [Appendix C] give a description of this chart as applied to Gayomart. For commentary on the article and the chart see Raffaelli, *L’oroscopo del mondo*, 63–65 (Raffaelli comments on Pingree’s works as below, 65–66). See discussion of the chart’s Indian roots in D. Pingree, ‘Indian Influence on Sasanian and Early Islamic Astronomy and Astrology’, *Journal of Oriental Research (Madras)* 34–35 (1964–65): 118–26, esp. 123; and idem, ‘Māshā’allāh: Some Sasanian and Syriac Sources’, in *Essays on Islamic Philosophy and Science*, ed. George F. Hourani (Albany: State University of New York Press, 1975), here 5–6; also idem, *From Astral Omens to Astrology*, 39–40; also E. G. Raffaelli, ‘Il tema del mondo e il tema del Gayomard nel Bundahišn’, in *Giovanni Schiaparelli: storico della astronomia e uomo di cultura. Atti del Seminario di studi organizzato dall’Istituto Italiano per l’Africa e l’Oriente e dall’Istituto di Fisica Generale Applicata dell’Università degli Studi di Milano. Milano, 12–13 Maggio 1997, Osservatorio Astronomico di Brera*, ed. Antonio Panaino and Guido Pellegrini (Milan: Mimesis—Istituto italiano per l’Africa e l’Oriente, 1999). For Indian examples, see D. Pingree, ed., trans. and comm., *The Yavanajātaka of Sphujidhvaja*, 2 vols. (Cambridge, MA/London: Harvard University Press, 1978), at 8, 5 and 8, 12; and G. Pellegrini, ‘Le configurazioni planetarie e la nascita di Rāma: una comunicazione de



FIGURE 5.4

The Birth of Mithras from a Cosmic Egg (Housesteads Monument, Hadrian's Wall [CIMRM 860]) (photograph courtesy and with the kind permission of the Great North Museum, Hancock, Northumberland and the Society of Antiquaries of Newcastle).

esis is found in a ca. third-century CE Mithraic monument. The monument postdates Antiochus, but is still relevant because it gives evidence of a similar conception in another Mithraic venue.

The Housesteads Monument shows the birth of Mithras from an egg. It depicts Mithras in the centre, surrounded by images of zodiac signs forming

G. V. Schiaparelli ad A. Weber', in *Giovanni Schiaparelli: storico della astronomia e uomo di cultura. Atti del Seminario di studi organizzato dall'Istituto Italiano per l'Africa e l'Oriente e dall'Istituto di Fisica Generale Applicata dell'Università degli Studi di Milano. Milano, 12–13 Maggio 1997, Osservatorio Astronomico di Brera*, ed. Antonio Panaino and Guido Pellegrini (Milan: Mimesis—Istituto italiano per l'Africa e l'Oriente, 1999). The *Yavanajātaka*, ch. 8, 5 states that a chart with all planets in signs of their exaltations produces a 'lord of the earth bounded by the seas' (Pingree, *Yavanajātaka*, vol. 2, 27); ch. 8, 12 says when all planets are in their own houses, it produces 'an emperor (rājādhirāja)' (Pingree, *Yavanajātaka*, vol. 2, 28), not a god, as Antiochus says. But note that Antiochus says that planets in their exaltations signify an illustrious nativity; could this be the origin of the Indian practice leading to the Iranian exaltation *thema* applied to Gayomart? Raffaelli, *L'oroscopo del mondo*, 147, also suggests this idea: 'Questa dottrina [in Antiochus] era probabilmente presente nel testo greco da cui fu tradotto il *Yavanajātaka*, e fu sviluppata et arricchita nel testo sanscrito con elementi propri della tradizione indiana.'

a womblike shape around him. One wonders if this shape was deliberately meant to suggest the delivery of the fetus at the time Aquarius was literally beginning its ascent (recall Porphyry's comment, at the beginning of this chapter, that 'rising places are proper to the gods'¹³⁴). The zodiac's order is clockwise (i.e. primary or diurnal motion), beginning with Aquarius in the bottom lower left, culminating with Cancer and Leo at the top, and finishing with Capricorn in the lower right. Certainly on one level, as Beck points out, this represents the lunar and solar houses of the planets¹³⁵ (we should note that only by beginning the zodiac with Aquarius in the lower left and moving clockwise could Cancer and Leo end up at the top). But Mithraic symbolism can be multi-layered, and this arrangement could equally show the ascent and descent of the soul, as Beck also proposes.¹³⁶ Beck has also noticed, via the arrangement of the planetary houses, a connection to the *thema mundi*, suggesting that the depiction of the world's birth is a fitting image for the birth of its ruler, Mithras.¹³⁷ Beck has not, however, made the next logical step: that this particular, non-traditional *thema mundi* could also contain within itself, and represent, the symbolic birthchart of Mithras, using not Cancer as its Ascendant but Aquarius. Antiochus, the heir of his Mithras-loving ancestors, has taken the familiar birthchart of the world and given it a new perspective, still keeping the planets in their own houses, but using the lunar, not the solar, ones; and by so doing has created the birthchart of a god, Mithras.

3.3 *Other Implications of the thema dei*

There may also be a daimonic component in the *thema dei*'s rôle of exemplifying a way to ascend to a godlike state. CHX states that one of the stages humans pass through in their ascent towards divinity is that of a daimon: 'human beings take hold of the beginning of immortality as they change into *daimons*, then in this manner [coming] into the chorus of gods; there are two choruses

134 (Seminar Classics 609, 28.15): ... θεοίς μὲν τὰ ἀνατολικά [sc. οἰκεῖα]. ... 'ἀνατολικά' can also mean eastern, and the astrological Ascendant, of course, is the zodiac sign and degree on the eastern horizon at the time of birth.

135 Beck, *Planetary Gods and Planetary Orders*, 35–38; idem, *Religion of the Mithras Cult*, 219–20; idem, *Beck on Mithraism*, 157.

136 Beck, *Planetary Gods and Planetary Orders*, 41–42. He was speaking primarily of the Trier monument (which contains a half-zodiac, Aries to Virgo), but also mentions the Housesteads one. We have seen DeConick's proposal of the appropriation of its ascent by the Ophites, but the egg *birth* of Mithras, in my view, is the key to its primary intent.

137 *Ibid.*, 39.

of gods, one wandering and the other fixed.¹³⁸ The ‘wandering’ and ‘fixed’ gods, plainly planets and stars, demonstrate the astral component in this ascent.

In addition to a *thema dei*, some ways of determining eminence in an astrological chart are based on the planets in signs of dignity. Along with other criteria, those of noble or elevated status are said to have charts containing dignified planets (especially by house and exaltation, or if the triplicity lords of the sect luminary are dignified). Vettius Valens uses the Lot of Exaltation (using the arc between the Sun and Aries by day, and the Moon and Taurus by night) for distinguished births in 11, 19, with examples in 11, 22 (especially the first).¹³⁹ Someone trying to become more god-like, in a Hermetic or Mithraic ritual, moves from the earth to the stars, from human to daimon and thence to god. In astrology, the example of the *thema mundi/thema dei* provides a view of the pinnacle for the same kind of ascent. Chapter Six will explore additional themes of daimons and stars in the context of the Magical Papyri, the *Hermetica* and the decans. These daimons, too, will vary in their functions depending on the uses to which they are put.

138 CH X, 7.10–13, (Nock and Festugière, *CH* I, 116.14–17): αἱ δὲ ἀνθρώπινοι ἀρχὴν ἀθανασίας ἴσχουσιν εἰς δαίμονας μεταβάλλουσαι, εἴθ' οὕτως εἰς τὸν τῶν θεῶν χορόν· χοροὶ δὲ δύο θεῶν, ὁ μὲν τῶν πλανωμένων, ὁ δὲ τῶν ἀπλανῶν. (See also the translations of Copenhagen in *Hermetica*, 31–32; and Scott in *Hermetica: The Ancient Greek and Latin Writings which Contain Religious or Philosophic Teachings Ascribed to Hermes Trismegistus*, ed. and trans. Walter Scott, 4 vols (Oxford: Clarendon Press, 1926), here vol. 1, 191, 193.) Fowden, *The Egyptian Hermes*, 83 and n. 38, also points out the similarities with PGM IV.475–575.

139 Considering a planet's dignity by house or exaltation is also important in profections (Valens, IV, 13).

Ambivalent Daimons and Astrology

For *daimons*, like humans, vary in virtue and vice.

PLUTARCH, *De Iside et Osiride*, 25, 360E¹

This chapter examines more texts from the Greco-Roman period to Late Antiquity which contain astrology and ‘ambivalent’ daimons, both good and evil. Specifically, these are the daimons of the Magical Papyri, the Hermetic texts, and the decans of Hellenistic astrology. They are helpers *or* hinderers of human actions and what befalls humans: those who aid human endeavours, but also those who thwart them; those who cause illnesses (physical and mental) and injury, and those who cure them. In these texts the powers of good daimons often help humans ward off the effects of bad daimons. Ambivalence also applies when a daimon acts either beneficently or malefically depending on circumstances. In the Magical Papyri and Hermetic texts we come the closest to the realm of magic and where astrology and the daimon intersect with it. The decans provide another venue for ‘daimonic’ and astral concerns. Thus the chapter includes an overview of the decans from their origin in the Egyptian Middle Kingdom to their use in the astrology of late antiquity.

I also use ‘ambivalent daimons’ in another sense: considering the ‘divinity’ of the daimon. What is the relationship between gods and daimons, and the line between them in regard to how they function and what they are able to do, within the astrological milieu? Can a god also be a daimon? What distinguishes gods from daimons?

The objectives of this chapter focus on the interplay between good and bad daimons: how the actions of one lead to the responses of the other, as well as on the further segregation of the good daimons who become classed as ‘angels’ and the bad daimons, classed as ‘demons’, which takes place in the world of late antiquity. Important also is the case of the daimon whose response is either beneficial or malicious, the quintessential ‘ambivalent daimon’. A further objective considers the interplay between gods and daimons. The final goal of this chapter is to see how astrological practice integrates with these concerns, and the areas of astrological technique which contain manifestations of them.

1 γίγνονται γὰρ, ὡς ἐν ἀνθρώποις, καὶ δαίμοσιν ἀρετῆς διαφοραὶ καὶ κακίας. Trans. J. Gwyn Griffiths (modified slightly), in Plutarch, *Plutarch's de Iside et Osiride*.

1 Daimons and Astrology in the Magical Papyri

The Magical Papyri² are an eclectic collection of Greek and Demotic texts drawn from Egyptian,³ Greek, Gnostic, Hermetic, Jewish and Mithraic sources. Just investigating daimons in the papyri would be a major study in itself,⁴ so we shall only explore the intersections between the daimon (in whatever form) and astrology in these texts. There are numerous references to daimons of all kinds in the Magical Papyri,⁵ including good, bad and personal daimons, as well as the deity called Agathos Daimon.⁶

Of the texts which mention daimons or astrology, some give spells for warding off bad daimons or exorcising them, appeal to good daimons (especially Agathos Daimon, whose functions are godlike) or angels, and exhort that rituals be performed at the proper astrological time (*katarchai*). For texts combining daimons with astrological practice, the following are of interest: PGM IV.1637–95, PGM IV.2967–3006, PGM VII.505–28, PGM XIII.1–343, PGM XIII.343–646, PGM XIII.646–734, PGM XIII.734–1077 AND PDM XIV.1–114.⁷ They give instructions for finding a personal daimon, performing a rite and invoking gods and good daimons at the proper astrological time, and being able to change the fated parts of one's astrological birthchart by appealing to a good daimon.

2 My primary resource for the Magical Papyri is Betz, ed., *GMP*, because it includes Demotic as well as Greek material. For the Greek I use the standard critical edition, K. Preisendanz, *Papyri Graecae Magicae. Die griechischen Zauberpapyri*, 2nd ed., ed. and trans. Karl Preisendanz, (Stuttgart: B. G. Teubner, 1973–1974).

3 See R. K. Ritner, 'Egyptian Magical Practice under the Roman Empire: the Demotic Spells and their Religious Context', in *ANRW*, vol. II, 18.5, ed. Wolfgang Haase (Berlin/New York: Walter de Gruyter, 1995), esp. 3358–71.

4 See G. Sfameni Gasparro, 'Magie et démonologie dans les *Papyrus Graecae Magicae*', *Res Orientales* 13 (*Démons et merveilles d'Orient*) (2001): 157–74; and H. G. Gundel, *Weltbild und Astrologie in den griechischen Zauberpapyri* (Munich: C. H. Beck, 1968) for work in this regard.

5 A search of these texts in the *TLG* retrieves more than 30 substantial passages mentioning daimons. Forms of the word 'daimon' are mentioned 160 times in the papyri (Preisendanz edition).

6 Sfameni Gasparro, 'Magie et démonologie', 163–69, details five categories of daimons: invasive or possessing, spirits of the dead, prophetic, companion (*paredros*) and personal.

7 See brief coverage of the Agathos Daimon in magical papyri in D. Ogden, *Drakōn*, 300, 306–07.

1.1 *Picking Herbs at the Right Time*

PGM IV.2967–3006 is a ritual for picking herbs, and uses a katarchic chart,⁸ selected for ‘a favourable hour and on a favourable day’ in which to pick the herbs at their most efficacious:

I take you with Good
Fortune and Good Daimon, in both a favourable hour and on a favourable
day, successful for all things.⁹

Though the phrase ‘with Good Fortune and Good Daimon’ appears without subsequent instruction in another spell (PGM VIII, 51),¹⁰ it may have a double meaning here. ‘Good Fortune’ and ‘Good Daimon’ are the usual linked deities, but the subsequent phrase suggests they may have been symbolically incorporated in the selected chart by the placement of planets (especially benefics or luminaries) in the fifth and/or eleventh place, the astrological places of Good Fortune and Good Daimon.

1.2 *Meeting your Daimon*

A katarchic chart is also used for meeting or communicating with one’s personal daimon in PGM VII.505–528.¹¹

Communicating with One’s Daimon

505

Hail, Tyche and Daimon of this place, and present
hour and the present day, and every day. Hail,
the surrounding environment which is earth and heaven. Hail, Sun; for
you are the one who

8 Ogden, *ibid.*, 307 and n. 192 ignores the requirement of the right time to pick the herb, mentioning the Agathos Daimon here merely as a bringer of good luck.

9 IV.2999–3001 (Preisendanz, I, 168): λαμβάνω σε σὺν Ἀγαθῇ Τύχῃ καὶ Ἀγαθῷ Δαίμονι καὶ ἐν καλῇ ὥρᾳ καὶ ἐν καλῇ ἡμέρᾳ καὶ ἐπιτευκτικῇ πρὸς πάντα. Vettius Valens uses the same phrase, καλῇ ὥρᾳ, when discussing katarchic charts: see, e.g., *Anthology*, IX, 12.28–31 (Pingree, 341.25–342.3); see also the discussion in Chapter 1, 3.5.

10 VIII.50–52 (Preisendanz, II, 47): καὶ πράξον μοι πάντα καὶ συνρέπ<ο>ις σὺν Ἀγαθῇ Τύχῃ καὶ Ἀγαθῷ Δαίμονι, ἤδη, ἤδη, ταχύ, ταχύ. (‘And do everything for me and incline to me with Good Fortune and Good Daimon, now, now, quickly, quickly.’)

11 PGM VII.505 (Preisendanz, II, 23): Σύστασις ἰδίου δαίμονος. See J. Bergman, ‘Ancient Egyptian Theogony in a Greek Magical Papyrus (PGM VII, ll. 516–521)’, in *Studies in Egyptian Religion: Dedicated to Professor Jan Zandee*, ed. Heerma van Voss, Matthieu Sybrand, and Huibert Gerard (Leiden: E. J. Brill, 1982), 28, n. 3. The word σύστασις can mean either meeting or communication, among other things. See LSJ, s.v. σύστασις, A.1 and 2.

has set yourself over the holy firmament with an unseen light
 ORKORĒTHARA. You are the father of the born again Aion 510
 ZARACHTHŌ. You are the father of unapproachable Nature
 THORDJOPHANŌ.
 You are the one who has in yourself the mixture of cosmic nature
 and the one who begot the 5 wandering stars, who are the innards of
 heaven
 and bowels of earth, the inundation of waters and
 boldness of fire AZAMACHAR: A[N]APHANDAŌ: EREUA; ANEREUA; 515
 PHENPHENSŌ ĪGRAA: you are the youth, well born, born within the
 holy shrine, coming into being together with the holy pool called Abyss,
 set beside the two pedestals SKIATHI and MANTŌ. And
 the 4 foundations of the earth were shaken, the master of the whole,
 holy Scarab: AŌ; SATHREN Abrasax: IAŌAI AEŌ; 520
 ĒŌA: ŌAE: IAŌ: IĒO: EU: AE: EU: IE: IAŌAI.' Write the name in myrrh ink
 on two male eggs; and cleanse yourself thoroughly with one,
 lick off the name, break it and throw it away. Hold the other in your partly
 open right hand, showing [it] to the Sun at sunrise and [...] 525
 olive branches. Lift up your right hand,
 supporting the elbow with your left hand, and say the formula 7 times,
 crack the egg and swallow it up. Do this for 7 days,
 reciting the formula at sunrise and sunset.¹²

The spell begins: 'Hail, Tyche and Daimon of this place, and present hour and the present day, and every day. Hail, the surrounding environment which is earth and heaven. Hail, Sun; for you are the one who has set yourself over the

12 VII.505–28 (Preisendanz, II, 23–24). Σύστασις ἰδίου δαίμονος. 'χαίρετε, Τύχη καὶ δαίμων τοῦ τόπου τούτου καὶ ἐνεστῶσα ὥρα καὶ ἡ ἐνεστῶσα ἡμέρα καὶ πάσα ἡμέρα. χαίρε, τὸ περιέχον, ὃ ἐστὶν γῆ καὶ οὐρανός. χαίρε, Ἥλιε· σὺ γὰρ εἶ ὁ ἐπὶ τοῦ ἀγίου στηρίγματος σεαυτὸν ἰδρύσας ἀοράτῳ φάει Ὀρκορηθαρα. σὺ εἶ ὁ πατήρ τοῦ παλιγγενοῦς Αἰῶνος Ζαραχθῶ: σὺ εἶ ὁ πατήρ τῆς ἀπλάτου Φύσεως ΘΟΡΧΟΦΑΝΩ. σὺ εἶ ὁ ἔχων ἐν σεαυτῷ τὴν τῆς κοσμικῆς φύσεως σύγκρασιν καὶ γεννήσας τοὺς ε' πλανήτας ἀστέρας, οἳ εἰσιν οὐρανοῦ σπλάγχχνα καὶ γῆς ἔντερα καὶ ὕδατος χύσις καὶ πυρὸς θράσος: ἀζαμαχαρ: α[ν]αφανδαῶ: ερευα· ανερευα· φενφενσω: ἰγραα: σὺ εἶ ὁ νέος, εὐγενής, ἔγγονος ὁ τοῦ ἀγίου ναοῦ, ὁ συγγενῆς τῆ ἱερᾷ λίμ<ν>ῃ, τῆ καλουμένη ἄβυσσῳ, παρεστῶση ταῖς δυοσι βάσεσιν σκιαθι: καὶ μαντω· καὶ ἐκινήθη τῆς γῆς τὰ δ' θεμελίαια, ὁ τῶν ὄλων δεσπότης, ἄγιε κἀνθαρε: αω· σαθρεν Ἀβρασάξ: ιαωαι αεω· ηωα: ωαη: Ἰάω: ιηο: ευ: αη: ευ: ιε: ιαωαι.' τὸ ὄνομα γράφε ζυμυρνομέλανι εἰς ὡὰ δύο ἄρρηνικά· καὶ τῷ μὲν ἐνὶ περικαθαίρεις σεαυτὸν καὶ ἐκλείξας τὸ ὄνομα ἔκβαλε κατὰξας. τὸ δ' ἕτερον κράτει τῆ δεξιᾷ χειρὶ παρανεωγμένη δεικνύων τῷ ἡλίῳ πρὸς ἀνατολὰς καὶ <ἐστεμμένους> ἐλαίας κλάδους. ἔπαιρε δέ σου τὴν χεῖρα τὴν δεξιάν τῆ εὐωνύμῳ ὑποβαστάξας τὸν ἀγκῶνα καὶ εἰπὼν τὸν λόγον ζ' καὶ ἀπολέψας ῥόφησον. ποίει ἐπὶ ἡμέρας ζ' πρὸς ἀνατολὴν καὶ δύσιν διῶκων τὸν λόγον. My translation following Bergman in some parts.

holy firmament with an unseen light.¹³ Hailing ‘present hour and the present day’ implies the importance of beginning of the ritual chosen at the proper astrological moment (the *katarche*). The local Fortune and Daimon are verbally propitiated; again, the phrasing ‘Tyche and Daimon of this place’ could be a double entendre, referring not only to the local deities, but to the *katarchic* chart and the literal astrological places of Good Fortune and Good Daimon, as in the previous spell. That spell also uses an astrologically propitious beginning for the ritual.

I see parallel constructions in this text between Tyche and the specific place, present hour and day (local space and time) and the larger, visible material world (the ‘surrounding environment’); and between Daimon and ‘every day’, the general concept of day created by the solar cycle, and the Sun itself as lord of the firmament who has an ‘unseen light’ (its light prevails even though unseen when it is under the earth). Parallels between Tyche and the material world (often the body) and Daimon and the Sun are, as demonstrated already in this book, not unusual.¹⁴

Jan Bergman pointed out the strong Egyptian influence on this spell, especially regarding lines 516–21.¹⁵ He makes a convincing case which connects the Sun’s (the Egyptian god Re) descriptions here with the gods Khepri and Atum. Khepri is the god of becoming, of coming into being, represented by the scarab,¹⁶ while Atum is the primordial creator god of Heliopolis, often combined with Re as Re-Atum.¹⁷ The links with Agathos Daimon and the Sun are also clear; we find such links elsewhere in the Greek Magical Papyri¹⁸ and in astrological texts where Sun and daimon are connected.¹⁹

13 VII.506–9 (Preisendanz, II, 23). H. Martin Jr., in Betz, ed., *GMP*, 132, translates τὸ περιέχον as ‘Universe’, which seems not quite right. Bergman, ‘Ancient Egyptian Theogony in PGM VII’, 29, suggests ‘All-Embracing’, much closer to the Greek meaning; Preisendanz offers the similar ‘Umfassendes’.

14 The reference to the Sun as having an unseen light suggests links with the non-material and noetic. It may also be a tiny indication of why the Lot of Daimon is later characterised by Arabic astrology as the Lot of the Absent or Hidden (i.e. unseen).

15 Bergman, ‘Ancient Egyptian Theogony in PGM VII’, 30–37.

16 *Ibid.*, 32.

17 Morenz, *Egyptian Religion*, 260.

18 Such as PGM IV.1596–1715, an invocation to Helios as Agathos Daimon, ‘... who rises from the four winds, the propitious Agathos Daimon, for whom heaven has become the place of procession’ (ll. 1605–1610 [Preisendanz, I, 124]): δεῦρό μοι, ὁ ἀνατέλλων ἐκ τῶν τεσσάρων ἀνέμων, ὁ ἰλαρὸς Ἀγαθὸς Δαίμων, ᾧ οὐρανὸς ἐγένετο κωμαστήριον); and PGM XXXVI.211–230, a prayer to Helios, you who are ‘the Good Daimon of the world’ (ll. 216–17 [Preisendanz, II, 170]): ὁ Ἀγαθὸς Δαίμων τοῦ κόσμου).

19 See Chapter 9, section 1 (‘The Lots and their Luminaries’), 305–07 and Table 9.1.

But why the allusions to the Sun as Agathos Daimon, and how does this connect with astrology and communicating with one's personal daimon?²⁰ First, the Sun's ties to Khepri and Atum in Egyptian doctrine are not unusual; as early as the Pyramid Texts, three phases of the sun in the morning, at noon and in the evening were each associated with the gods Khepri, Re and Atum (Khepri in the morning, Re at noon and Atum in the evening).²¹ The Sun is thus connected with all facets of creation but, with Atum as the setting sun, represents not only the beginning of life but also the end. The procedure after the invocation involves two male eggs²² (symbols of life), which Bergman also connects with Khepri and Atum.²³ Thus we have a symbolic cycle of coming-to-be and passing-away, of birth and death controlled by the sun and, in its daily journey through the heavens and under the earth, linked to gods representing birth and death. The greetings at the beginning of the spell show a move from lesser to greater, from the local fortune and daimon, from the specific hour and day of the astrological chart to the surrounding environment of the whole earth and heaven, culminating with the Sun. The Sun as the overarching Good Daimon, in a kind of reverse synecdoche (the whole for a part, or the greater for the lesser), then stands for the personal daimon of the invoker, and represents the cause of his birth and death as well. The invoker prays to the Agathos Daimon to meet his own agathos daimon.

Another invocation to the Sun, PGM XXXVI.211–30, also suggests a katararchic chart for the time of the rite (and links the Sun with Khepri and Atum as youth and old man, rising and setting).²⁴

Rejoice with me, you who have been set over the east and over the cosmos, whom all the gods accompany, at your good hour, your good day, the Agathos Daimon of the world, the crown of the inhabited world, the one rising from the abyss, every day being born as a youth and setting as an old man. . . . but [let me] take and seize from you life, health, reputation, wealth, power, strength, good luck, loveliness, favour for all men and

20 H. D. Betz, 'The Delphic Maxim "Know Yourself" in the Greek Magical Papyri', *History of Religions* 21, no. 2 (1981): 156–71, here 161–62, has analysed this spell in regard to the personal daimon, but I do not agree with his conclusions.

21 Morenz, *Egyptian Religion*, 145 and n. 31.

22 Lines 522–527. See H. Martin Jr.'s comment in Betz, ed. *GMP*, 132, n. 85, for the lore on how to sex an egg by shape.

23 Bergman, 'Ancient Egyptian Theogony in PGM VII', 37.

24 *Ibid.*, 34–35.

all women, victory over all men and all women. Yes, master . . . make the matter which I want, by your power.²⁵

Again we see references to a good hour and day, as well as a word used for a *katarche*, *pragma*,²⁶ in the last phrase of the prayer. We see as well the astrological term used for the attendants of the Sun, *doryphoroi*, planets within a certain distance of the Sun in an astrological chart, who serve as his bodyguards.²⁷ The chart is created at the best astrological time to propitiate the Sun, with the Sun in a good place and accompanied by planets which can help him. In addition, the boons sought from the Agathos Daimon/Sun are similar to those which describe the astrological places, or points such as the Lot of Fortune or Daimon.²⁸

1.3 *Changing your Fate: The Eighth Book of Moses*

PGM XIII (P. Leiden J 395)²⁹ contains texts said to be from the 'Eighth Book of Moses', including rites of initiation using planetary gods and astrological ritual. Two versions (not identical) of the text are given: an earlier, pagan one (Version B,

-
- 25 PGM XXXVI.214–19, 23–27, 29–30 (Preisendanz, II, 170): 'χαίρε μοι, ὁ ἐπὶ τοῦ ἀπηλιώτου τεταγμένος καὶ τοῦ κόσμου, ὃν δορυφοροῦσιν οἱ θεοὶ πάντες, ἀγαθῆ σου ὥρα, ἀγαθῆ σου ἡμέρα, ὁ Ἄγαθος Δαίμων τοῦ κόσμου, ὁ στέφανος τῆς οἰκο<u>μένης, ὁ ἐκ τῆς ἀβύσσου ἀνατέλλων, ὁ καθ' ἡμέραν γεννώμενος νέος καὶ γέρων δύνων . . . ἀλ[λ'] ἐλεῖν καὶ λαβῖν παρὰ σου ζοήν, ὕγίαν, δόξαν, πλοῦτον, δύναμιν, ἰσχύν, ἐπιτυχίαν, ἐπαφροδίσια, χάριν πρὸς πάντας ἀνθρώπους καὶ πρὸς πάσας γυναῖκας, γί[κ]ηγ κατὰ πάντων ἀνθρώπων καὶ κατὰ πασῶν γυν[αι]κῶν. ναί, δέσποτα . . . ποίησον, ὁ βούλομαι πράγμα, τῆ σῆ δυνά[μ]ι.' My translation following R. F. Hock in Betz, ed., *GMP*, 274.
- 26 Olympiodorus, e.g., in his commentary on Paulus's *Introduction*, refers on several occasions to 'every nativity and every sort of matter' (ch. 16; Boer, 30.3–4): . . . πάσης γενέσεως καὶ ἐπὶ παντοῦ πράγματος . . . ; sim. at Boer, 30.12, 18; 32.16, 21; 47.15; 65.19; 89.2–3, 12), clearly differentiating between natal and katarthic astrology.
- 27 See S. Denningmann, *Die astrologische Lehre der Doryphorie: Eine soziomorphe Metapher in der antiken Planetenastrologie* (Munich/Leipzig: K. G. Saur, 2005).
- 28 Life = 1st place, health = 6th, reputation = 10th, wealth = 2nd, good luck (*epituchia*) = 5th; loveliness (*epaphrodisia*) is used by Vettius Valens (IV, 4.3; Pingree, 152.2–3, 153.4) to describe effects of the Lot of Fortune. Certainly these are common life desiderata, but it is worth pointing out that astrological parallels exist.
- 29 Text and German translation in Preisendanz II, 86–131; an edition, with photographs and transcription, is R. W. Daniel, ed., *Two Greek Magical Papyri in the National Museum of Antiquities in Leiden. A Photographic Edition of J 384 and J 395 (= PGM XII and XIII)*, Papyrologica Coloniensia (Opladen: Westdeutscher Verlag, 1991). English translation by M. Smith in Betz, ed., *GMP*, 172–95; and T. E. Klutz, trans., 'The Eighth Book of Moses', in *Old Testament Pseudepigrapha: More Noncanonical Scriptures*, vol. 1, ed. Richard Bauckham,

lines 343–734) and a later, ‘Christianising’ one (Version A, lines 1–343); this accounts for instructions often occurring twice in the document.³⁰ A ruling (‘presiding’)³¹ god is found through a technique combining the gods of the planetary week (here called ‘Greek’) with the gods of the ‘heptazone’ (the seven-zoned spheres of the planets in Chaldean order) (lines 213–24, 718–30). The ritual should begin only when the new moon is in Aries (lines 5–6, 347–49). The ruling god tells the initiate about the fate determined for him at his birth, his own daimon and his astrological birth-chart. The relevant passages for our discussion are:

1. An angel will come in, and you say to the angel: ‘hail, lord. Initiate me by these acts of mine, and recommend me [to the god], and let the [components] of my nativity be revealed to me; and if he says something bad, say: ‘expunge the evil parts of my fate. . .’³²

James R. Davila, and Alexander Panayotov (Grand Rapids, MI: Wm. B. Eerdmans Publishing Co., 2013), 189–235.

- 30 I use the word ‘Christianising’ based on the analysis of T. Klutz, ‘Jesus, Morton Smith and the *Eighth Book of Moses* (PGM 13.1–734)’, *Journal for the Study of the Pseudepigrapha* 21, no. 2 (2011): 133–59, here 152–54. The quantity of versions have been the subject of earlier scholarship on this text. Again I follow Klutz’s latest offering, ‘Jesus, Morton Smith and *Moses VIII*’, as against Morton Smith in Betz, ed., *GMP*, 181, *annotation; and M. Q. Smith, ‘The Eighth Book of Moses and How It Grew (PLEid. J 395)’, in *Atti del XVII congresso internazionale di papirologia*, ed. Marcello Gigante (Naples: Centro internazionale per lo studio dei ercolanesi, 1984), 683–93; reprint, in *Studies in the Cult of Yahweh*, ed. Shaye J. D. Cohen (Leiden: E. J. Brill, 1996), 217–26. Klutz, 136, lays out the history of the scholarship. I thank Claire Chandler for a copy of Klutz’s article. (Klutz summarises similarly: Klutz, trans., ‘Eighth Book of Moses’, 189–90.)
- 31 ‘πολεύοντος’ (lines 213, 718), the technical astrological term for a planet presiding over a day and specific hour of a day: see Paulus, ch. 21. Previous translators have missed the technical significance of πολεύω, but it is clear that what Paulus describes, using the exact verb the papyrus uses, is what is meant here and in other references to gods of the days and the hours (at lines 118–22, 674–79, and especially 53–60 and Version B’s 424–32, where B correctly says that the method for determining the hourly, daily and weekly gods’ names is at the end of the text, 718–30). Having said that, the papyrus’s actual method for finding the presiding god differs from that in Paulus, and seems to be unique.
- 32 PGM XIII.608–14 (Preisendanz, II, 115–16): . . . εἰσελεύσεται ἄγγελος, καὶ λέγει τῷ ἀγγεῷ ἔλω· χαίρει, κύριε, καὶ τέλεσόν με τοῖς πράγμασί μου τούτοις καὶ σύστησόν με καὶ μηνύεσθω μοι τὰ τῆς γενέσεώς μου.’ καὶ ἐὰν εἴπῃ τι φαῦλον, λέγει· ἀπάλειψόν μου τὰ τῆς εἰμαρμένης κακὰ . . . *Genesis* here is not ‘birth’ as Smith, in Betz, ed., *GMP*, 187 and Klutz, trans., ‘Eighth Book of Moses’, 223 have rendered, but ‘nativity’, i.e. the astrological birth-chart (also used in the same context in line 620). Preisendanz, II, 115, translated this correctly: ‘der Inhalt meines Horoskops’ (assuming he means the entire birthchart, not just the Ascendant).

2. Safeguard me from all my personal astral [fate], undo my filthy fate, apportion goods for me in my nativity, increase my manner of living also by means of many goods . . .³³
3. And you inquire, ‘Master, what is allotted for me?’ And he will tell you about your star and what kind of daimon you have and your hour-marker, as well as where you may live and where you will die. But if you hear something bad, do not shriek, do not howl, but beg that he expunge or treat it. For this god can do all things.³⁴

These passages on the initiate’s birthchart and changing its material fate appear in Version B but are omitted in the ‘Christianised’ Version A.³⁵ The three passages develop the same subject matter. The first and second passages are contained within the same section dealing with the initiate’s presentation to the god and the god’s power over *heimarmenē* in the birthchart. The third passage expands on this theme by connecting the specific details of the birthchart with the personal daimon, the life of the initiate and the god’s ability to affect the events of the life.³⁶

33 PGM XIII.633–37 (Preisendanz, II, 116): διαφύλαξόν με ἀπὸ πάσης τῆς ἰδίας μου ἀστρικής, ἀνάλυσόν μου τὴν σαπρὰν εἰμαρμένην, μέρισόν μοι ἀγαθὰ ἐν τῇ γενέσει μου, αὔξησόν μου τὸν βίον καὶ ἐν πολλοῖς ἀγαθοῖς . . . ‘Safeguard’ is Klutz’s apt translation (Klutz, trans., ‘Eighth Book of Moses’, 223). Again, *genesis* is the astrological birthchart. I disagree with Klutz, trans., ‘Eighth Book of Moses’, 223, that ‘τὸν βίον καὶ ἐν πολλοῖς ἀγαθοῖς’ should be taken as separate phrases; it is material goods which improve the manner of living. I do not think *bios* refers to longevity.

34 PGM XIII.708–14 (Preisendanz, II, 119): σὺ δὲ πυθάνου· δέσποτα, τί μοι εἴμαρται; καὶ ἐρεῖ σοι καὶ περὶ ἄστρου καὶ ποιός ἐστιν ὁ σὸς δαίμων καὶ ὁ ὥροσκόπος, καὶ ποῦ ζῆση καὶ ποῦ ἀποθανεῖσαι. ἐὰν δὲ τι φαῦλον ἀκούσης, μὴ κράξῃς, μὴ κλαύσης, ἀλλὰ ἐρώτα, ἵνα αὐτὸς ἀπαλείψῃ ἢ μεθοδεύσῃ. δύναται γὰρ πάντα ὁ θεὸς οὗτος. Preisendanz, who originally (1931) translated ‘ὥροσκόπος’ as ‘Horoskop’ in the PGM (the same in subsequent editions), changed his opinion in K. Preisendanz, ‘Review of “Wilhelm Gundel, Dekane und Dekansternebilder”’, *GGA* 201 (1939): 129–49, here 135, n. 1: ‘meine Übersetzung “dein Horoskop” ist in “Stundenschauer”, “Dekan” zu ändern.’ Gundel, *Weltbild und Astrologie*, 20 and 68, n. 14, believes the ‘ὥροσκόπος’ is a decan; Klutz, trans., ‘Eighth Book of Moses’, 227 and note a, chose ‘ascendant decan’, conflating two possible meanings for ὥροσκόπος: but see below, 2.1, 210–11.

35 Noticed also by Klutz, ‘Jesus, Morton Smith and *Moses VIII*’, 138, yet he apparently considers this difference ‘negligible’ (139).

36 A text containing material relating to the changing of fate, but with different parameters, is P. Berlin 10525, a ‘Sarapis Aretalogy’ (better, a ‘Sarapis Dream Oracle?’), *editio princeps* A. Abt, ‘Ein Bruchstück einer Sarapis-Aretalogie’, *ArchRW* 18 (1915): 256–68, with a recent critical edition and German translation by M. Totti, *Ausgewählte Texte der Isis- und*

Let us look at some of the terminology in these passages. ‘διαφύλαξόν με ἀπὸ πάσης τῆς ἰδίας μου ἀστρικῆς’ in the second passage was translated by Morton Smith as ‘Protect me from my own astrological destiny’.³⁷ This is an odd phrase, with odd wording. If, in fact, *heimarmenē* is implied with *astrikē*,³⁸ then the initiate is assuming the power of the god to change the astrological chart (with its material constraints) that has been allotted for him. Thus the god can change the initiate’s material fate by changing his chart, as we see in the phrase ‘apportion goods for me in my nativity’, etc. This is tantamount to treating the natal chart as katarchic, having the god give the initiate a personal chart which takes advantage of the best moment for birth. In this ritual, the god symbolically and literally apportions by means of the astrological birthchart.

Both the first and third passages refer to the ‘expunging’ of bad fate. Ἀπαλείφω is the word used when expunging a record, thus erasing evidence of its existence. The invoked god³⁹ thus has the power to change the record of a life given in the chart. The third passage uses both ἀπαλείφω and μεθοδεύω; the latter means to treat by method or rule, and is often used in medical contexts. So the god can expunge the record or treat it, even ‘cure’ it, using the rules (of astrology?). If the god can make changes in the outcomes of the natal chart, then this can affect subsequent astrological techniques such as profectio or

Sarapis-Religion, 29–31 (no. 12); Greek text and English translation in D. L. Page, *Select Papyri III: Literary Papyri, Poetry* (London/Cambridge, MA: Harvard University Press, 1950), 424–29. In this text Sarapis is able to change the untimely death date of a pauper by exchanging it with that of a Libyan, suffering and in pain, whose time of death according to the fates has not arrived. The exchange is possible because the two share the same birthchart (συναστρία; note that this word is used by Ptolemy, *Tetr.* IV, 7.435, 476, 502 (Hübner), in the sense of temporary ‘friendships’ of stars), but here it appears to mean the two have similar charts (see F. Boll, *Kleine Schriften zur Sternkunde des Altertums* (Leipzig: Koehler & Amelang, 1950), ‘Sternenfreundschaft’ and ‘Synastria’, 115–25). The text is noteworthy for our purposes because Sarapis, of course, has links to the Agathos Daimon (see above, Chapter 3). R. Merkelbach, *Isis regina—Zeus Sarapis*, 217–19, sees the exchange as positive for both participants, unlike Page, *Select Papyri*, 426–27, who thinks the Libyan gets the short end of the stick (he may, though, be cured in the end). But in this text only times of death are in Sarapis’s control, not changing the birthchart itself. The text does contain an interesting remark: Sarapis says he can ‘change the garments of the Moirai’ ([τὰς] μοίρας γὰρ ἐγὼ μεταμφιάζω, line 13), and specifically against their will (παρὰ δὲ μοίρα[ν], line 12). This, as Morenz, *Egyptian Religion*, 74 already noticed, has similarities with Isis conquering fate (τὸ εἰμαρμένον) (see Chapter 3, 1.3).

37 In Betz, ed., *GMP*, 187.

38 The gloss in LSJ, s.v. ἀστρικός, has this very example.

39 Sarapis has been interpolated here; as we saw in Chapter 3, he is linked to the Agathos Daimon.

time lords. (This may be the reason for using the more inclusive word *ἀστρική* rather than *genesis* or *thema* in the first clause of the second passage.)

Here we see active astrology at work. These passages are not about accepting one's static, unchangeable fate, but about entreating the god to *change* the outcomes of one's chart to make things better. This is not so much astrological magic as it is magical (or better, religious) astrology, relying not on human abilities to make changes, but propitiating the god for divine intervention and assistance. It is, actually, the antithesis of a 'fatalistic' astrology; the chart, and the events of the life, are not immutably cast, but are able to be ameliorated by divine action. Its outlook, which relies on the ability to petition the gods to change fate through prayer and ritual is very Egyptian (not to mention Babylonian), as we saw in Chapter Three.

1.4 *The 'Tenth' Book of Moses*

PGM XIII.734–1077, follows the just-discussed 'Eighth Book of Moses', and may be a 'Tenth Book of Moses'.⁴⁰ It mentions both the Agathos Daimon and astrology, and has commonalities of language with several other texts, i.e. PGM XII.201–69, PGM XXI.1–16 and PGM IV.1596–1715.⁴¹

[761] Come to me, you from the four winds, ruler / of all, who blew spirit into humans for / life, whose name is hidden and not to be spoken /... / [765] at whose name even the daimons, when they hear it, are terrified, whose is the sun... [768] and the moon... [769]—they are untiring eyes / shining in the pupils of human eyes—of whom / heaven is head, aither body, earth feet, / and what surrounds you water, the Agathos Daimon... [780] Yours are the good effluences of the stars, daimons, and Fortunes, and / Moirai, from whom wealth is given, good old age, / good children, [good] fortune, a good burial.⁴²

40 The text implies a 'tenth' book (line 1078) but does not supply a noun.

41 Their similarities are striking; note that PGM XII and XIII (Leiden J 384 and J 395) were both found at Diospolis (Thebes East); PGM XXI (Berlin 9566) has only Egypt as provenance, and PGM IV (Paris 574 is probably from Thebes (provenances at <http://www.trismegistos.org/magic/search.php> [searching on place and inventory no., accessed 30 April 2015]). PGM XII.238–44, 252–57 and PGM XXI.1–16 are more or less equivalent to PGM XIII.761–83. PGM IV.1596–1715, in language very similar to the others, has an invocation to Helios as Agathos Daimon, '... who rises from the four winds, the propitious Agathos Daimon, for whom heaven has become the place of procession' (PGM IV.1605–09 [Preisendanz, I, 124]): ὁ ἀνατέλλων ἐκ τῶν τεσσάρων ἀνέμων, ὁ ἰλαρὸς Ἀγαθὸς Δαίμων, ᾧ οὐρανὸς ἐγένετο κωμαστήριον.)

42 PGM XIII.761–63, 765–66, 768–72, 780–83: (761) 'δεῦρό μοι, ὁ ἐκ τῶν δ' ἀνέμων, ὁ παντοκράτωρ, ὁ ἐνφυσήσας πνεῦμα ἀνθρώποις εἰς / ζωὴν, οὗ ἐστὶν τὸ κρυπτόν ὄνομα καὶ ἄρρητον / ... /

In this spell the Agathos Daimon is the lord of all⁴³ and the Sun and Moon are his eyes.⁴⁴ ‘Ordinary’ daimons are terrified at the sound of his name. Not only that, but his ‘are the good effluences of the stars: daimons, and Fortunes, and Moirai, from whom wealth is given, a good old age, good children, [good] fortune, a good burial.’⁴⁵ A passage at the end of this text gives the chart conditions for engraving a lamella (beginning at line 1003), where an important criterion is the condition of the moon (it should be in a good phase and in aspect to benefics in their own houses).⁴⁶ In this text the Agathos Daimon is represented as a god, whose powers eclipse those of ordinary daimons. Thus the line between god and daimon is blurred.

1.5 *The Dodekaoros*

PGM IV.1637–95 gives a list of the *Dodekaoros*,⁴⁷ along with the magical names for each animal. The *Dodekaoros* is of Egyptian origin, and assigns twelve animals to each double hour as the Sun moves daily through the zodiac.⁴⁸ In this

(765) οὐ καὶ οἱ δαίμονες ἀκούοντες τὸ ὄνομα / πτωῦνται, οὐ ὁ ἥλιος.../(768) καὶ <ή> σελήνη.../(769) ὀφθαλμοὶ εἰσὶν ἀκάματοι, / λάμποντες ἐν ταῖς κόραις τῶν ἀνθρώπων, ᾧ/(770) οὐρανὸς κεφαλὴ, αἰθὴρ δὲ σῶμα, γῆ δὲ πόδες, / τὸ δὲ περὶ σ<ε> ὕδωρ* ὁ Ἄγαθὸς Δαίμων... (780) <σ>οὐ αἱ ἀγαθαὶ ἀπόρροιαὶ/(781) τῶν ἀστέρων εἰσὶν δαίμονες καὶ Τύχαι καὶ/(782) Μοίραι, ἐξ ὧν διδοται πλοῦτος, εὐγενεσία,/(783) εὐτεκνία, τύχη, ταφή ἀγαθή. *τὸ... ὕδωρ emended by Daniel, ed., *Two Greek Magical Papyri*, xxvi. Smith, in Betz, ed., *GMP*, 190 n. 116, emended <σ>ου as Preisendanz did (II, 75) in parallel text XII.254. Note that the photograph in Daniel, ed., *Two Greek Magical Papyri*, 65, does not show a c.

- 43 ‘παντοκράτωρ’. The same epithet for him appears in PGM XIV, 9. Cf. the Agathos Daimon as ruler of the cosmos in PGM XXXVI.214–19 (above, 1.2 and n. 25).
- 44 In astrological doctrine, the Sun rules the right eye of a human, and the Moon the left eye: Valens I, 1.2, 5 (Pingree, 1.10, 20). (The right and left eyes of Horus are also the Sun and Moon.)
- 45 PGM XIII.780–83 (Preisendanz, II, 122–23). Wealth, long life, children and a good burial are exactly the favours granted to humans by the four *kas*, associated with various Egyptian deities, including Shai/Agathos Daimon: see S. Sauneron, ‘La conception égyptienne du bonheur. À propos des “Quatre Ka” (Esna 319)’, *BIFAO* 57 (1958): 163–64; Smith, *On the Primaeval Ocean*, 23–24; O. E. Kaper, *The Egyptian God Tutu*, 64. These commentators did not notice the similarity to PGM XIII.780–83 and its astrological connection (R. K. Ritner, in Betz, ed., *GMP*, 190, n. 117, mentions an Egyptian connection here, but not the four *kas*).
- 46 PGM XIII.1027–39. These conditions are standard in astrological technique; for a *katarche*, the state of the moon is always important because it moves so quickly.
- 47 Similar at PGM XXXVIII.1–26 (Betz, ed., *GMP*, 278–79) but missing text after the 8th hour.
- 48 See the discussion in Chapter 5, 173. These double hours were correlated to zodiac signs, as on the Daressy Zodiac, an astrologer’s board (see below, 1.6 and 4.9). It takes on average two hours for a sign to move across the Midheaven degree; the time it takes for a sign to cross over the Ascendant is variable, based on the sign in question. For treatments

text, the Sun is again connected to the Agathos Daimon, especially in his serpent form which links to Shai (see Chapter Three). The first and last sentences make this clear:

(*first*) ‘You are the great serpent leading these gods, the one who holds the beginning of Egypt and the end of the whole inhabited world, who mates in the ocean, PSOI PHNOUTHY NINTHĒR’; (*last*) ‘I entreat earth and heaven, and light and darkness, and the god who brought about all things, SAROUSIN, you, Agathon Daimonion the companion assistant . . .’⁴⁹

The *vores magicæ* in the first sentence give the Egyptian for ‘Shai, the god of gods’ (*p3 šy p3 ntr n3 ntr.w*).⁵⁰ The *vox magica* in the second may be a corruption of Sarapis. Note that the great Agathos Daimon himself is the companion assistant of the invoker.

1.6 Getting What you Wish for

Demotic Papyrus PDM XIV.1–114 is a vessel divination containing instructions for casting a chart to achieve ‘everything that you wish’.⁵¹ Again, the Agathos

of the Dodekaoros, see F. Boll, *Sphaera: Neue griechische Texte und Untersuchungen zur Geschichte der Sternbilder* (Leipzig: B. G. Teubner, 1903), ch. 12, 295–346; Gundel, *Dekane*, 216–20 and table, 223; R. Gleadow, *The Origin of the Zodiac* (London: Jonathan Cape, 1968), 216–17, 219, Table 24; W. Hübner, ‘Zur neoplatonischen Deutung und astrologischen Verwendung der Dodekaoros’, in *ΦΙΛΟΦΡΟΝΗΜΑ: Festschrift für Martin Sicherl zum 75. Geburtstag. Von Textkritik bis Humanismusforschung*, ed. Dieter Harlfinger (Paderborn/Munich: Ferdinand Schöningh, 1990).

49 PGM IV.1637–43 (Preisendanz, I, 124): σὺ εἶ ὁ μέγας Ὀφίς, ἡγούμενος τούτων τῶν θεῶν, ὁ τὴν ἀρχὴν τῆς Αἰγύπτου ἔχων καὶ τὴν τελευταίην τῆς ὄλης οἰκουμένης, ὁ ἐν τῷ ὠκεανῷ ὀχεύων, Ψοῖ φνουθι νινθηρ. . . . And PGM IV.1707–11 (Preisendanz, I, 126): ὀρκίζω γῆν καὶ οὐρανὸν καὶ φῶς καὶ σκότος καὶ τὸν πάντα κτίσαντα θεὸν μέγαν Σαρουσιν, σέ, τὸ παρεστώς Ἀγαθὸν Δαιμόνιον . . . Translation Morton Smith in Betz, ed., *GMP*, 68–69, modified.

50 See a similar construction at PGM III.144–45, Preisendanz, I, 38: ψοειω ψοειω π[ν]ουτε νεντηρ τηρ[ου. . .]. (See the notes of R. K. Ritner in Betz, ed., *GMP*, 22, n. 36 and 68, n. 210.) See also the discussion of these PGM texts in relation to an Egyptian cosmology, in Smith, *Primaeval Ocean*, 210; this cosmology features Pshai as the creator god. Smith suggests, 211, that both PGM texts and the cosmology relied on the same source.

51 PDM xiv.63 (III, 5); sim. at PDM xiv.112 (IV, 20). (I have tried to correlate the line numbers in Betz with the column and line numbers in Griffith and Thompson.) This is part of the Great Magical Papyrus of London and Leiden: F. L. Griffith and H. Thompson, *The Demotic Magical Papyrus of London and Leiden*, 2 vols. (London: H. Grevel and Co., 1904–1905, repr. Milan: Cisalpino—La Goliardica, 1976) (vol. 1 = F. L. Griffith and H. Thompson, eds, *The Leyden Papyrus: An Egyptian Magical Book* (New York: Dover Publications, 1904,

Daimon (called ‘Pshai’) plays a large part, both in the divination and in the casting of the chart. The god who deals with the inquiry, called ‘the Shai of today’,⁵² is summoned by a youth through Anubis. This god is ‘the one to whom these moments belong’, implying that he is lord of the day or the hour in which the entreaty is made. Katarchic charts often rely on the astrological lord of the day or hour.⁵³ It is interesting that Shai/Agathos Daimon is invoked as the lord of the day of the ritual, since he is a god of fate, and astrology is a means for determining a fate; yet the fate can be manipulated by casting a chart for the right time to achieve ‘everything which you wish’.

After performing other rituals (lines 63–92; col. III, 5–35), preparations for casting such a chart are made (lines 93–114; col. IV, 1–19). The chart is prepared by the god Imhotep (Asclepius in Greek), famously associated with astrology (col. IV, 1).⁵⁴ Then the god ‘speaks with you with his mouth opposite your mouth in truth concerning everything that you wish’ (col. IV, 20).⁵⁵ The repetition of

repr. 1974), same pagination); see 20–43. Also in Betz, ed., *GMP*, 195–201 (translation by Janet Johnson and W. C. Grece). An analysis of this portion of the papyrus has been made by J. Dieleman, ‘Stars and the Egyptian Priesthood in the Graeco-Roman Period’, in *Prayer, Magic, and the Stars in the Ancient and Late Antique World*, ed. Scott Noegel, Joel Walker, and Brandon Wheeler (University Park, PA: The Pennsylvania State University Press, 2003), 146–50; and in idem, *Priests, Tongues, and Rites: The London-Leiden Magical Manuscripts and Translation in Egyptian Ritual (100–300 CE)* (Leiden/Boston: Brill, 2005), 123–26, but with different objectives than mine.

- 52 PDM xiv.60 (III, 3), translated by both Johnson and Thompson as Agathos Daimon: Johnson in Betz, ed., *GMP*, 198; Griffith and Thompson, *The Demotic Magical Papyrus of London and Leiden*, vol. 1, 32–33; the Demotic has *p šy*.
- 53 See Paulus, ch. 21 (Boer, 41.18–42.15). Finding the lord of the day leads to knowing the lord of the hour. For more on this, see Chapter 4, 4.1, 134–35 and Table 4.1; and above, 1.3 and n. 31.
- 54 See Neugebauer and Van Hoesen, *GH*, 42, No. 137c, line 6: ‘Asclepius, that is Imouthes, son of Hephaestus’ (ακκληπιου ο εστιν μουθου υιος ηφηετου); see also Firmicus, III, 1.1 (KSZ 1, 91.12–13 = Monat, II, 15): ‘... itaque ... voluerunt secuti Aesculapium et Hanubium. ...’ ‘So [Petosiris and Nechepso] wished ... to follow Aesculapius and Anubis. ...’ (see Chapter 5, 186–87 and n. 121). For more on Asclepius-Imhotep and the chart in *GH*, see G. R. S. Mead, *Thrice Greatest Hermes: Studies in Hellenistic Theosophy and Gnosis, Being a Translation of the Extant Sermons and Fragments of the Trismegistic Literature with Prolegomena Commentaries and Notes* (York Beach, ME: Samuel Weiser, 1906, repr. 1992), 320–22, 324–26.
- 55 Col. IV, 20: *hr ir:f sdy wb3.k n r:f wb3 r.k n mt.t m'3.t hr hb nb iw ir:k wh3 r:f*. Modern Demotic transliteration by Micah Ross. The hand copy in Griffith and Thompson, *The Demotic Magical Papyrus of London and Leiden*, vol. 2, pl. 4 (transliteration and translation in vol. 1, 42).

the phrase ‘everything that you wish’ (at cols III, 5 and IV, 20) connects the two parts of the ritual together. The chart is then constructed:

You place a board for horoscopy⁵⁶ [lit. ‘reading the hours’] upon the bricks,⁵⁷ and you place the stars upon it, and you write your matter on a new roll of papyrus, and you place it on the board. It makes your stars appear to you when they are favourable for your matter.⁵⁸

The text, with its invocation of the god who will speak to you personally and grant ‘everything you wish’, using a katarchic chart, has some phrasing similar to that of PGM CX, analysed by Zola Packman.⁵⁹ As a loan-word from the Greek *πίναξ*, the Demotic is transliterated as ‘*pyngs*’ (col. IV, 21) and ‘*pyn*’ks’

56 See the gloss of this phrase in the *CDD*, vol. 5, 134, s.v. ‘š, ‘in compounds *pngs n* ‘š *wnw.t*’. In this context, the *pinax* (tablet or board) is the device by which the astrological chart was shown to the client. For the use of *pinax* as a loan word in this and other texts, see D. G. Greenbaum and M. T. Ross, ‘Various Renderings of Πίναξ in Greek and Demotic at Medīnet Mādī’, in *Astrology in Time and Place*, ed. Nicholas Campion and Dorian Gieseler Greenbaum (Lampeter, Wales: Sophia Centre Press, in press); also Dieleman, ‘Stars and the Egyptian Priesthood’, 148–49; idem, *Priests, Tongues and Rites*, 123, 126.

57 Bricks are involved in summoning the god: see col. IV, 3–8.

58 Col. IV, 21–22: [21] *hr ir.k w3h w^c pyngs n* ‘š-*wnw.t hr n3 tb.tw; mtw.k w3h n3 syw.w hr 3.t.f; mtw.k sh p3y.k* ‘š-*shn r w^c d^cm n m3y* [22] *mtw.k w3h.f hr p3 pyn*’ks; *hr ir.f di-ih n3y.k syw.w n.k, iw.w wd3 hr p3y.k* ‘š-*shn*. (Modern Demotic transliteration by M. Ross.) Trans. M. Ross and D. Greenbaum, in Greenbaum and Ross, ‘Various Renderings of Πίναξ. Handcopy in Griffith and Thompson, *The Demotic Magical Papyrus of London and Leiden*, vol. 2, pl. 4; transliteration and translation, vol. 1, 42. I suggest that ‘š-*shn*, ‘matter’, may be the equivalent of Greek *πράγμα*, the word used for a katarchic chart in Olympiodorus (see n. 26). I am even inclined (cautiously) to suggest that ‘š-*shn* in this kind of context specifically means a katarchic chart or equivalent (note that we see Greek *πράγμα* in this context in PGM XXXVI.230 [see above, 200 and n. 25]). The initiate is requesting a chart favourable for his concerns at the time. This usage has certain similarities with the saying in the (probably late Ptolemaic, though the dating is not certain) *Instruction of Ankhsheshonq*, 14.17, translated by Lichtheim as ‘Good fortune [‘š-*shn nfr*] turns away destruction by a great god.’ (Lichtheim, *Ancient Egyptian Literature*, vol. III, 170.) Her n. 52, p. 182, explains why she translated ‘š-*shn nfr* as ‘good fortune’ rather than good ‘deed’ (the usual meaning of *shn*). A good condition is able to forestall destruction. The context of our later text applies this to the katarchic chart. Both Demotic ‘š-*shn* and Greek *πράγμα* have similar connotations: ‘š-*shn* ‘order, affair, business, matter, intent’ (*CDD*, vol. 5, 135, s.v. ‘š-*shn*) and *πράγμα* ‘deed, act, occurrence, matter, affair’ (LSJ s.v.). The katarchic chart is seen as a positive action correlating favourable conditions in the heavens with favourable circumstances on earth.

59 Packman, ‘Instructions for the Use of Planet Markers’, 85–95. CX.1–3: ‘A voice comes to you speaking. Let the stars be set upon the board...’ [...]ς φωνή σοι ἔρχεται ὄμ[ι]λοῦσα·

(col. IV, 22). A *pinax* would be inscribed (at least) with the signs of the zodiac within a circle divided into twelve compartments; stone or gem markers for each of the planets were placed according to their positions in the birthchart of the client.⁶⁰ ‘You place the stars upon it’ is a clear reference to these planetary markers being placed in their proper places on the board. Thus Shai, as lord of the day, plays a part in the creation of a chart to fulfil the wishes of the requester.

2 Daimons and Astrology in the *Hermetica*

The importance of both daimons and astrology to Hermetic ideas of how the world functions is starkly expressed by Garth Fowden: ‘... the Hermetists’ understanding of cosmic sympathy was intimately linked with their daemonology and their astrology...’⁶¹ Through the astral hierarchy of stars, Sun and planets, daimons again provide a medium of action and interaction with humans. The Hermetic texts make clear that there are both good and bad daimons in the world: ‘They (sc. daimons) are both good and bad in their natures, that is, their activities (*energeia*); for the essence of a daemon is activity. But some of them are mixtures of good and bad.’⁶² A sampling of the way daimons are incorporated with astrological theory and practice in the *Hermetica* will show their importance for Hermetic models, especially in the realms of incarnation and birth. We shall return to one of these texts in our discussion of the decans (as well as the use of the word *energeia*, seen here describing the activity of the daimon).

2.1 *Birth Daimons From the Stars*

CH XVI lays out clear links between the stars and planets, the incarnation of the soul, and the daimons who govern humans. (This schema is followed in Porphyry’s essay *On What is Up to Us*.)⁶³ There are indications that the indi-

κείσθω<ν> δὲ ἐπὶ τοῦ πίνακος ἀστέρες... Packman’s translation, 92–93. Packman does not mention the similarities between her text and this one.

60 See Evans, ‘The Astrologer’s Apparatus’. Several of these have been found (see below, 4.9).

61 Fowden, *The Egyptian Hermes*, 78.

62 CH XVI, 13.5–7 (Nock and Festugière, CH II, 236.8–10): ... ἀγαθοὶ καὶ κακοὶ ὄντες τὰς φύσεις, τουτέστι τὰς ἐνεργείας. δαίμονος γὰρ οὐσία ἐνέργεια· εἰσὶ δὲ τινες αὐτῶν κεκραμένοι ἐξ ἀγαθοῦ καὶ κακοῦ. Text and English translation in *Hermetica*, ed. and trans. Scott, vol. 1, 268–71; English translation in *Hermetica*, trans. Copenhagen, 60.

63 See Chapters 7 and 8 for more on this essay.

vidual daimons assigned to each person are each in charge of a degree of the zodiac: 'The daimons on duty at the exact moment of birth, arrayed under each of the stars, take possession of each of us as we come into being and receive a soul. From moment to moment they change places, not staying in position but moving by rotation.'⁶⁴

Although this may refer to the decan rising at the time of birth (if a preceding passage of the text does refer to decans),⁶⁵ it also recalls the Myth of Er and puts into an astrological framework a personal daimon connected with the Ascendant degree: this degree, as the one on the eastern horizon at the moment of birth, is the astrological analogue and marker of the moment of appearance in the material world. Such texts connect the concept of Egyptian decans to the development of the astrological ascendant.⁶⁶ Evidence demonstrates that in this and other passages which refer to 'horoscopes' (e.g. *Asclepius* 19 and PGM XIII.708–14), a conflation has been made between the rising decan stars and the rising degree of the zodiac, i.e. the Ascendant.⁶⁷ The rising decan is

64 XVI, 15.1–5 (Nock and Festugière, *CH* II, 236.18–22): γενόμενον γὰρ ἡμῶν ἕκαστον καὶ ψυχωθέντα παραλαμβάνουσι δαίμονες οἱ κατ' ἐκείνην τὴν στιγμὴν τῆς γενέσεως ὑπηρεταί, οἱ ἐτάγησαν ἑκάστω τῶν ἀστέρων· οὗτοι γὰρ κατὰ στιγμὴν ἐναλλάσσονται, οὐχ οἱ αὐτοὶ ἐπιμένοντες ἀλλ' ἀνακυκλούμενοι· Trans. Copenhaver, *Hermetica*, 60.

65 See Nock and Festugière, *CH* II, 240, n. 35 (cited in Copenhaver's note, 206). The prior text which seems to refer to decans is XVI.13: 'The sun sets in array the troop or, rather, troops of demons, which are many and changing, arrayed under the regiments of stars, an equal number of them for each star. Thus deployed, they follow the orders of a particular star . . .' (Copenhaver's translation, 60 [Nock and Festugière, *CH* II, 236]: ὑπὸ τούτῳ δὲ ἐτάγη ὁ τῶν δαιμόνων χορός, μάλλον δὲ χοροί· πολλοὶ γὰρ οὗτοι καὶ ποικίλοι, ὑπὸ τὰς τῶν ἀστέρων πλινθίδας τεταγμένοι, ἑκάστω τούτων ἰσάριθμοι. διατεταγμένοι οὖν ὑπηρετοῦσιν ἑκάστω τῶν ἀστέρων) But in XVI.15.1–5 the phrase 'moment to moment' (κατὰ στιγμὴν) suggests the quicker movement of single degrees versus the 10-degree span of a decan.

66 Greenbaum and Ross, 'The Role of Egypt in the Development of the Horoscope'.

67 *Ibid.*, 162, 165–66. Passages in Porphyry's essay *On What is Up to Us* seem to use the word 'horoscope' in two senses (Section 42, Wachsmuth, 170–71; see also Porphyry, *Porphyry: To Gaurus on How Embryos are Ensouled and On What is in Our Power*, trans. and comm. James Wilberding (London: Bristol Classical Press/Gerald Duckworth and Company, 2011), 145). His first use of the word, describing 'horoscopes' from the Egyptians (Wachsmuth, 170.1) may in fact mean the Egyptian decans called 'Horoscopes'. But his subsequent references to 'horoscopes' mean 'the degree of the Ascendant' (we are given a clue about this in 170.5–6, where he says 'the horoscopic degree'). In a second passage (170.13–15) he even uses the same phrase, κατὰ στιγμὴν, used in XVI, 15.1–5, suggesting he means 'Ascendant' and not 'decan'. By his time, 'Ascendant' would have been the common meaning of ὠροσκόπος.

replaced by the rising zodiac sign, the degree of which ‘marks the hour’).⁶⁸ Where the Ascendant falls determines where planets and luminaries are positioned within the chart. If equating the Ascendant degree with a particular daimon correctly interprets this passage, then we also have a connection to the daimon and fate (*heimarmenē*), since the astrological term for ‘degree’ is *moira* (see Appendix I.A, 3.3).

The passage then explains that the daimons enter only the two non-rational parts of the soul; the highest part, rational and noetic, ‘stands unmastered by the daimons, suitable as a receptacle for God.’⁶⁹ The sun, though, does connect with the noetic and rational (as well as the sensible), and a hierarchy is given:

The noetic cosmos, then, depends from god and the sensible cosmos from the noetic, but the sun, through the noetic cosmos and the sensible as well, is supplied by god with an influx of good. . . . Around the sun are the eight spheres that depend from it: the sphere of the fixed stars, the six of the planets, and the one that surrounds the earth. From these spheres depend the daimons, and then, from the daimons, humans. . . . The noetic essence governs heaven; heaven governs the gods [i.e. planets as gods], and daimons subjoined to the gods govern humans. This is the army of gods and daimons.⁷⁰

Let us explore this further for its relationship to astrology and daimons. The Sun is connected with both *nous* and *aisthesis*; we have already seen these connections in astrology (see Chapter One). There is some confusion, because the text is talking about two different manifestations of the Sun: a noetic and

68 Bouché-Leclercq, *AG*, 222, remarks on the term *ώροσκόποι* being applied to the decan stars rising in the east, referring to what is now chart No. 95 in *GH* (P. Lond. 98), where they are called ‘the 36 bright horoscopes’: *οί λαμπροί λς’ ώροσκόποι*. See the analysis in Greenbaum and Ross, ‘The Role of Egypt’, 158–62.

69 *XVI*, 15.8–9 (Nock and Festugière, *CH II*, 236.25–26): *ἀδέσποτον τῶν δαιμόνων ἔστηκεν, ἐπιτήδειον εἰς ὑποδοχὴν τοῦ θεοῦ . . .* The highest, primary god is meant here. See Chapter 1 for more on the primary god.

70 *XVI*, 17.1–7 (Nock and Festugière, *CH II*, 237.11–17): *ἤρτηται οὖν ὁ νοητὸς κόσμος τοῦ θεοῦ, ὁ δὲ αἰσθητὸς τοῦ νοητοῦ, ὁ δὲ ἥλιος διὰ τοῦ νοητοῦ καὶ αἰσθητοῦ κόσμου τὴν ἐπιρροὴν ἀπὸ τοῦ θεοῦ χορηγεῖται τοῦ ἀγαθοῦ . . . περὶ δὲ τὸν ἥλιον αἱ ὀκτώ εἰσι σφαῖραι, τούτου ἠρτημένα, ἢ τε τῶν ἀπλανῶν, ἕξ τῶν πλανωμένων, καὶ ἡ μία ἢ περιγίεις· τούτων δὲ τῶν σφαιρῶν ἠρτηνται οἱ δαίμονες, τῶν δὲ δαιμόνων οἱ ἄνθρωποι* 18.1–4 (Nock and Festugière, *CH II*, 237.21–238.1): *. . . καὶ οὐρανὸν μὲν ἡ νοητὴ οὐσία διοικεῖ, οὐρανὸς δὲ θεοῦς, δαίμονες δὲ θεοῖς ὑποτεταγμένοι ἀνθρώπους διοικοῦσιν· αὕτη ἡ θεῶν καὶ δαιμόνων στρατιά.* Trans. Copenhaver, *Hermetica*, 61, slightly modified.

imaginal Sun linked to the highest god, above the cosmos; and the sensible 'planetary' Sun which represents it in the ethereal world of the cosmos.⁷¹ In this schema the noetic Sun is above the fixed stars and, with its light, is a mediator from god to the noetic to the sensible. Then come the fixed stars, which contain the zodiacal constellations in which the planets dwell. These planetary gods are mediated by daimons, who are in charge of humans. This is, then, the cosmic order (if I may be redundant) in which astrology and daimons play a part.

These daimons connect only to the two lower parts of the soul, where they can affect human desires and behaviour. When these are immoderate, they are ascribed to bad daimons who have not allied themselves with the highest divine and virtuous principles.⁷² Thus a lower class of daimons gets to be in charge of humans:

All others [*i.e.*, those whose noetic part is not illuminated by the divine ray of god] are led and carried off, both souls and bodies, by the daimons, because they adore the daimons' energies and acquiesce in them. [This is a love that] misleads and is misled. And so the daimons govern this whole earthly government through the instruments of our bodies; this government Hermes has called 'fate'.⁷³

Bodies and souls which are untouched by the noetic yearn for the activity or energy of the daimons, which is how the daimons are able to rule over the material world, a rule which is called *heimarmenē*. The influence of *heimar-*

71 For a clear description of the tripartite cosmos, consisting of hyper-cosmos, ethereal cosmos and material cosmos, see R. G. Edmonds, III, 'At the Seizure of the Moon: The Absence of the Moon in the Mithras Liturgy', in *Prayer, Magic, and the Stars in the Ancient and Late Antique World*, ed. Scott Noegel, Joel Walker, and Brandon Wheeler (University Park, PA: The Pennsylvania State University Press, 2003), here 227. The Emperor Julian, in his 'Oration to the Sun' (132c–133d) also refers to these three *kosmoi* and the noetic Sun which lies above the fixed stars.

72 This is reminiscent of Porphyry's description of bad daimons in *De abstinentia*, II, 38.4 (Nauck, 167.26–168.5); trans. Clark in *Porphyry. On Abstinence from Killing Animals*, 71.

73 XVI, 16.4–10, (Nock and Festugière, *CH* II, 237.4–10): οἱ δὲ ἄλλοι πάντες ἄγονται καὶ φέρονται καὶ τὰς ψυχὰς καὶ τὰ σώματα ὑπὸ τῶν δαιμόνων, ἀγαπῶντες καὶ στέργοντες τὰς ἐκείνων ἐνεργείας· καὶ τὸ λόγος οὐκ ἔρωσ' ἔστιν ὁ πλανώμενος καὶ πλανῶν· τὴν οὖν ἐπίγειον διοίκησιν ταύτην πᾶσαν διοικοῦσι δι' ὀργάνων τῶν ἡμετέρων σωμάτων· ταύτην δὲ τὴν διοίκησιν Ἑρμῆς εἰμαρμένην ἐκάλεσεν. My translation, but I have followed Copenhagen, trans., *Hermetica*, 61, in some phrases (and see his note to XVI.16, p. 207). The phrase between *cruces* was interpreted by Reitzenstein in *app. crit.*, Nock and Festugière, *CH* II, 237 as καὶ οὗτος ὁ ἔρωσ.

menē only on the material world is made very plain here. This love of bodies and souls for *energeia* is like the wandering planets (the verb *πλανάω* is telling here; is the planets' wandering a sign of their urge for *energeia*?), which as part of the material world are also subject to *heimarmenē*.

Another passage, from the *Asclepius*, describes the relationship of form and matter with gods, daimons and humans: 'It is impossible for bodies to be shaped without divine assent, for forms to be figured without the assistance of daimons, and without humans, soulless things cannot be started and kept going.'⁷⁴ This hierarchy mimics the heavenly one, in that the primary god gives assent to the sensible world, and the daimons provide the figuration of the forms thought by the primary god. The Latin *species* is the Greek *εἶδος*;⁷⁵ the use of the verb *figuro* recalls *figura*, the astrological term for a planetary configuration (the Greek *σχῆμα*), and may obliquely suggest that the daimons, as ministers of the planetary gods and governors of the corporeal human being, have something to do with the arrangement of the planets at the time of birth. Thus we come back to the statement in *xvi*, 15, that daimons connected to the stars come to us at the exact moment of our birth.

3 Decans and Daimons

Like the Magical Papyri and the Hermetic material, the literature on the decans is vast, and covers Egyptian astronomical and astrological delineations as well as decans in Hermetic and Gnostic sources.⁷⁶ (The thirty-six stars

74 *Asclepius* I, 5.6–9 (Nock and Festugière, *CH* II, 300.24–301.2): 'Corpora enim impossibile est conformari sine nutu divino, species figurari sine adiutorio daemonum; inanimalia institui et coli sine hominibus non possunt.' Translation Copenhagen, *Hermetica*, 69, slightly modified.

75 As Scott, ed. and trans., *Hermetica*, here vol. I, 293, n. 6: '*species* ... [*sc. mortales sunt*] = θνητὰ τὰ εἶδη ...'; and see his discussion of *eidōs* in vol. III, 15–18 (this reference also noticed by Copenhagen, trans., *Hermetica*, 217, s.v. 'forms').

76 The fundamental source on the Egyptian decans is Neugebauer and Parker, *EAT*. Other useful sources for Egyptian decans include Leitz, *Altägyptische Sternuhren*; and L. Kákosy, 'Decans in Late-Egyptian Religion', *Oikumene* 3 (1982): 163–91. For studies of decans particularly focusing on astrology and astronomy, see Gundel, *Dekane*; Boll, *Sphaera*; Bouché-Leclercq, *AG*, 215–39; the section on decans in Nock and Festugière, *CH* III, xxxviii–lxi; A. von Lieven, 'Die dritte Reihe der Dekane oder Tradition und Innovation in der spätägyptischen Religion', *ARG* 2 (2000): 21–36. The most recent comprehensive study is Quack, 'Dekane' (see his bibliography).

of the Babylonian text ‘Three Stars Each’ have also been analysed in relation to the concept of decans in Egypt and in Hellenistic astrology.)⁷⁷

My goal here is to explore why the decans are often considered to be daimons (or their equivalent), and how this conception affects their use in astrological technique. The two most prevalent systems of decans in Hellenistic astrology are connected both with planetary power and the daimonic power of the decan deities. As Gundel points out, they have both good and evil characteristics.⁷⁸ In astrological circles, the Egyptian decans were often used to chart the occurrence of disease and, as shown on the *Tablettes de Grand*, may have played a role in the treatment of disease at a major second century CE healing site in France.⁷⁹ In spite of Bouché-Leclercq’s disdain for them as an ‘excroissance parasite’, and his disparagement of them as religious superstition masquerading as scientific doctrine,⁸⁰ it is useful to know the religious background from which the decans spring (in addition to their astronomical and chronological functions), and that they are associated with both gods and daimons. Far from a ‘parasitic excrescence’, they are a very old, even integral part of Egyptian astral divination which gets incorporated into the doctrines and techniques of Hellenistic astrology.

3.1 *Origins and Features*

The oldest texts on the decans come from Ninth and Tenth Dynasty coffins in Asyut.⁸¹ Originally used to mark nocturnal hours, they became known as decans because different star groups rose at ten-day intervals.⁸² Decans in Egypt are associated with both gods and ‘daimons’, although the Egyptians themselves

77 B. L. van der Waerden, ‘Babylonian Astronomy. II. The Thirty-Six Stars’, *Journal of Near Eastern Studies* 8, no. 1 (1949): 6–26. But his argument of a relationship between these and Egypt’s decans is unconvincing, according to H. Hunger and D. Pingree, *Astral Sciences in Mesopotamia* (Leiden/Boston/Cologne: Brill, 1999), 52.

78 Gundel, *Dekane*, 240–43.

79 See J.-H. Abry, ed., *Les tablettes astrologiques de Grand (Vosges) et l’astrologie en Gaule Romaine: actes de la Table-Ronde du 18 mars 1992 organisée au Centre d’Études Romaines et Gallo-Romaines de l’Université Lyon III*, Collection du Centre d’Études Romaines et Gallo-Romaines. Nouvelle série no. 12 (Lyon: Centre d’Études Romaines et Gallo-Romaines, 1993).

80 Bouché-Leclercq, *AG*, 216. He suggests that their ‘arithmetical’ name, decans, helped to disguise their frankly religious origin.

81 Neugebauer and Parker, *EAT* I, 4–9, 16, 31.

82 *Ibid.*, I, 1; III, 1. See also O. Neugebauer, ‘The Egyptian “Decans”’, in *Vistas in Astronomy*, ed. A. Beer (London/New York: Pergamon Press, 1955).

do not use that word.⁸³ Since the decans are stars or constellations, the deities linked to them thus become a part of religious ritual and astral divination as it develops, especially in the New Kingdom and later. As representatives of decan stars, sub-beings very much like daimons represent and report to superior gods.⁸⁴ There are various kinds, each having similar attributes to the kinds of daimonic entities present in other Mediterranean cultures of the time. These include protective deities like Shai and Renenet (discussed in Chapter Three) as well as the fighters/slaughterers (*hꜣty.w*), emissaries (*hby.w*), messengers (*wꜣwty.w*) and wanderers (*šmꜣy.w*) (mentioned in Chapter Four, 1.2).

The 'arrows', *sheseru* (*šsr.w*) include the group of seven decan stars closest to the sun.⁸⁵ In another context, on a bracelet of Prince Hornakht from the tomb of Osorkon II, decans are associated with arrows of protection sent by gods of heaven, earth and underworld: 'Their arrows are defending your body in life and (safe) rule'.⁸⁶ Dimitri Meeks says that 'emissary demons, arrows and Decans were identified'.⁸⁷ Thus beings associated with the decans and their gods could both attack and protect, punish and guard, those with whom they came in contact. They could both cause illness and be propitiated to prevent it.⁸⁸ Because the decans rise and culminate at 10-day intervals, their influence is activated at these particular periods.⁸⁹ Thus the Egyptian tradition perceives these decanal beings, like daimons, as both destructive and protective.

83 See Chapter 3, 2.1 and the discussion of *ntr*, 97–98; Chapter 4, 1.2, 119, n. 19. Meeks, 'Génies, Anges, Démons en Égypte', 44, further notes that in the evolution of Egyptian gods, they become more remote and use intermediaries (both good and bad) for direct action and human contact.

84 For Egyptian ideas of greater and lesser gods, see Chapter 3, 2.1, 98 and n. 93.

85 Meeks, 'Demons', 105. Could these *sheseru* which guard the sun relate to the astrological concept of *doryphoria*, planets which guard the luminaries? Seven arrows also appear at Dendera and elsewhere: see R. Lucarelli, 'Demonology during the Late Pharaonic and Greco-Roman Periods in Egypt', 121–23; also, for Dendera, von Bomhard, *The Naos of the Decades*, 185.

86 Kákosy, 'Decans', 164 and 165, fig. 1. Kákosy stresses the idea of the decans as protectors (165), and that the *šsr.w* are also guardian divinities (164 and n. 9, citing *Wb* IV, 547). Both these attributes align with the usual concept of daimons as protective and guardian spirits. For more on arrows and decans, see A. von Lieven, *Der Himmel über Esna: eine Fallstudie zur religiösen Astronomie in Ägypten am Beispiel der kosmologischen Decken- und Architravinschriften im Tempel von Esna* (Wiesbaden: Harrassowitz, 2000), 24, 52, 156.

87 Meeks, 'Demons', 105; but Quack, 'Dekane', disagrees, §1.1. However, Quack does acknowledge that the *hꜣty.w* have a good chance of being connected to the decans (*ibid.*, §1.1).

88 Meeks, 'Demons', 105.

89 *Ibid.*

3.2 *Decans and Astrology in Egypt*

The long tradition of Egyptian decans was applied to astrology during its development beginning in the Ptolemaic period.⁹⁰ Important roles for the decans arose from this earlier tradition: decan stars were protectors and avengers; and decans were associated with injury, illness and specific body parts (melothesia) in an astrological setting. Now, too, decans were tied to the zodiac and their powers activated within that milieu. These transitions were preceded by other significant developments.

In the ninth century BCE, as the iconographic development of decans from godlike (human-formed) to animal and, especially, snake forms occurs,⁹¹ the decans link to gods who now oversee their functions and determine their actions at specific times. Evidence for this can be seen in the Twenty-second Dynasty tomb of the Pharaoh Osorkon II (ca. 850 BCE) where the decans change from the godlike representations in earlier periods to snake- or lion-headed deities.⁹² Kákosy notes the snake which appears in the midst of these gods, depicted as stretched out above the symbol for the earth, and labelled ‘*ḥꜥw* š’ (‘living ones of fate’, i.e. decans);⁹³ the š, he suggests, stands for ‘fate’ (šꜥw).⁹⁴

90 For antecedents and development of the decans in an astrological context, see Neugebauer and Parker, *EAT* III; Kákosy, ‘Decans’; Quack, ‘Dekane’; von Lieven, *Himmel über Esna*, 188–90, provides a helpful summary of the development of decans in relation to gods and stars, their functions and their place in a ‘religious astronomy’.

91 Kákosy, ‘Decans’, 163–64; von Lieven, ‘Die dritte Reihe’, 22–23.

92 Kákosy, ‘Decans’, 163–64; for discussion of the change, see also von Lieven, ‘Die dritte Reihe’, 22–23, who designates the snake-formed and human-formed decanal images respectively as a ‘first’ and ‘second’ series of decan iconography, and a ‘third series’, depicted with animal heads and snakes, connected closely with the zodiac and appearing on ‘magical’ gems and in iatromathematical texts.

93 ‘Living one of [a god] is a common divine epithet (*Wb* I, 201), but ‘living ones’ of fate may also apply to the decans: see J.-C. Goyon, ‘L’origine égyptienne des tablettes décanales de Grand (Vosges), I’ in *Les tablettes astrologiques de Grand (Vosges) et l’astrologie en Gaule Romaine: actes de la Table-Ronde du 18 mars 1992 organisée au Centre d’Études Romaines et Gallo-Romaines de l’Université Lyon III*, ed. Josèphe-Henriette Abry, *Collection du Centre d’Études Romaines et Gallo-Romaines* (Lyon: Centre d’Études Romaines et Gallo-Romaines, 1993), here 65, n. 12, where he says that at Esna the decans are called *bꜥw ḥꜥw*, ‘living *bas*’ (see *Wb* I, 414: *bꜥw* as stars, and even as decan-stars; *ḥꜥw* may also be stars, cf. *Wb* I, 204, ‘die Sterne’; Neugebauer and Parker, *EAT* III, 157). See also the extensive discussion of Esna 406 and its decans in von Lieven, *Himmel über Esna*, 42–55; also Bomhard, *Naos of the Decades*, 63–64, citing von Lieven, ‘Die dritte Reihe’, 42.

94 Kákosy, ‘Decans’, 164. In Demotic, šꜥw can be written šꜥ (*CDD*, vol. Š, 12).

Here, then, is some evidence of astral complicity in fate linked to the protective decan stars/gods.⁹⁵

The animal heads with which these decanic divinities are often depicted come from the gods (e.g. Sakhmet and Bastet)⁹⁶ with which they are associated. In the Ptolemaic and Greco-Roman periods decan cults expand to include connections with Isis-Sothis, Osiris, Hathor, Ptah, Amun and other prominent Egyptian gods.⁹⁷ In many of these monuments stars are pictured, showing that the original connection of the decans to the constellations rising at different hours of the night over ten-day periods is never forgotten.

The earliest evidence of decan stars associated with the decades (ten-day periods) is a Saite papyrus (ca. seventh-sixth c. BCE).⁹⁸ Later, similar and abundant evidence occurs on the Naos of the Decades,⁹⁹ where *khatyu* (fighters) and *shemayu* (wanderers) in particular are associated with decan stars.¹⁰⁰ On this monument, the decan stars as servitors carry out the will of the 'great god' (Shu-Sopdu), causing death and carnage for Egypt's enemies.¹⁰¹ A temple at *ʿĪt-nbs*, where the Naos was originally sited, may have been dedicated to the *khatyu*.¹⁰² But even though they are involved in destruction, these decan stars do so at the behest of their god, for Egypt's protection.¹⁰³ The specific actions and effects of these decan-warriors at specific times (the decades) presage the later use of decans in astrology proper, employing the zodiac.

95 See the remark of J.-H. Abry, 'Les noms des décans chez Firmicus Maternus (*Mathesis* IV, 22)', *RPh* 67, no. 2 (1993): 197–228, here 228: '... des décans, devenus génies du destin après avoir été génies du temps...'. See also von Lieven, *Himmel über Esna*, 181.

96 Kákosy, 'Decans', 166–68. For decans controlled by Sakhmet and Bastet, among others, see von Lieven, *Himmel über Esna*, 53–54; Kaper, *The Egyptian God Tutu*, 61, 68–69, 115.

97 Kákosy, 'Decans', 167 (statue of Sakhmet-Bastet and decans), 169 (statue of Isis and decans), 176 and 180.

98 von Bomhard, *Naos of the Decades*, 185, citing P. Cairo JE 89131–6 (unpublished).

99 A naos is a shrine, often with an indentation for a god's statue. The Naos of the Decades is also known as the Saft el-Henna Naos. For a discussion of decans and astrology on the Naos, see J. F. Quack, 'The Naos of the Decades and its Place in Egyptian Astrology', in *Alexandria and the North-Western Delta: Joint Conference Proceedings of Alexandria: City and Harbour (Oxford 2004) and The Trade and Topography of Egypt's North-West Delta (Berlin 2006)*, ed. Damian Robinson and Andrew Wilson (Oxford: Oxford Centre for Maritime Archaeology, Institute of Archaeology, 2010).

100 E.g., von Bomhard, *Naos of the Decades*, 183, Decade 37.

101 *Ibid.*, *Naos of the Decades*, 54 (cols 15–19), 64.

102 *Ibid.*, 196, 201–02.

103 For decan 'demons' as protective, see Meeks, 'Demons', 105–06; Kákosy, 'Decans', 164 and n. 9, 165; von Lieven, *Himmel über Esna*, 55.

The iconographical association with snakes is important for astrology, in that it complements the associations with fate via the god Shai, whose snake connections are unquestioned and who gives his name to the Demotic eleventh place. (This serpent motif will reappear in Chapter Ten of this book, in connection with astrological lots.) In ancient Egyptian culture, snakes represent protection and fertility as well as death and destruction; like the daimons of later antiquity, their functions are ambiguous, not purely good nor evil.) So several attributes of daimons (in both Egyptian and Greek guise)—i.e. their protective, ministering functions and their links to snakes, can be found in both earlier and later representations of decan gods in Egypt.

Also worth mentioning is the connection between decans, daimons and *šḥw*-spirits (*iḥy* in Demotic), which transformed from ‘spirits’ to ‘demons’ in Coptic, as Erik Iversen indicates.¹⁰⁴ Some decan names incorporate the word *šḥw*.¹⁰⁵ In the afterlife, the deceased becomes an *akh* in order to be effective, and *akhu* are part of a tri-partite system of soul-personality-spirit¹⁰⁶ which includes the *ba* and the *ka*. The *akh* is traditionally associated with light,¹⁰⁷ unlike the *ba* and *ka*; Iversen connects psyche and life to the *ba*, but the *akh* to light and the intellect.¹⁰⁸ The *bas* are also connected to decans, so soul as well as spirit takes part in decan doctrine.¹⁰⁹ (We can hardly avoid a comparison here with the astrological Sun/daimon and Moon/fortune: the Moon is often linked to life and the soul, while the Sun is linked to light and *nous*; again the astrological ties in with the religious and philosophical, both Egyptian and Greek.)

104 Iversen, *Egyptian and Hermetic Doctrine*, 45. Meeks, ‘Génies, Anges, Démons en Égypte’, 21, citing Crum, *CD*, 89a, concurs. (Note that examples in *CD* are primarily Biblical.) See also *Wb* 1, 15 (bottom), s.v. *šḥ*, I: ‘auch als Bezeichnung bestimmter Dämonen’; 16, III: ‘... Vgl. Kopt. i4’; J. Černý, ed., *Coptic Etymological Dictionary* (Cambridge: Cambridge University Press, 1976, repr. 2010), 50.

105 Neugebauer and Parker, *EAT* III, Tanis family, 145, nos. 22–23 (22—*tpy*-^c *šḥw*(*y*), 23—*šḥw*(*y*)); also Primary decans, 162, nos. 40–42 (40—*tpy*-^c *šḥwy*, in all groups and families, both rising and transit; 41—*šḥwy*, in all groups and families, both rising and transit; 42—*imy-ht šḥwy*, rising decan). See also *Wb* 1, 16, s.v. *šḥ*: ‘in Namen von Dekanestern’.

106 This categorisation is very simplified: for more on *ba* and *ka* and their meanings, see D. B. Redford, ed., *The Ancient Gods Speak: A Guide to Egyptian Religion* (Oxford/New York: Oxford University Press, 2002), s.v. ‘Ba’ and ‘Ka’.

107 See Iversen, *Egyptian and Hermetic Doctrine*, 45, who suggests that *šḥ* in its ‘light’ meaning also connects to the *akh*-spirits; see also F. D. Friedman, s.v. ‘Akh’ in Redford, ed., *Ancient Gods*, 7–8.

108 Iversen, *Egyptian and Hermetic Doctrine*, 33 (he does this in the context of showing the Egyptian roots of the Hermetic *Poimandres* 1, 17).

109 See *Wb* 1, 414, showing the *bšw* decans and *bšw* as a general term for stars.

Another important attribute of the astrological decans is their correspondence to different parts of the body, and this further cements their relationship with the illnesses that strike those parts of the body.¹¹⁰ We saw the association of the Evil Daimon and Bad Fortune places with illness and injury in Chapter Four. The decans also link to the illness and injury of specific body parts. It may even be that zodiacal melothesia stems from this association of the decans to parts of the body, based on which sign they are in.¹¹¹ Decans are used in iatromathematical texts like the 'Sacred Book of Hermes to Asclepius'.¹¹² Fragment 28 of Nechepso-Petosiris, as mentioned in Firmicus Maternus,¹¹³ also refers to the use of decans in astrological medicine.

In the depiction of decan divinities over time, we see a progression from a more godlike characterisation to a more daimonic one; in the Late Period (shown in Kákosy's documentation of the *menits* and amulets appearing at that time)¹¹⁴ the earlier decanic gods have metamorphosed into something akin to the way daimons are considered, as they add to their protective functions the attributes of snakes associated with daimons (as in the Ptolemaic period and later, when Shai is equated with the Agathos Daimon). We should not forget that the Egyptian term for decans from the Ptolemaic Period is *bʒk.ti.w*, from the word *bʒk*, 'servant'.¹¹⁵ The decans as daimonic entities become responsible for carrying out the wishes of the gods they represent, whether those wishes are to protect or avenge (like the *šsr.w*). This may be reflected in the Greek λειτουργός, servitor or minister, being associated with decans (or merely a

110 This too may have an Egyptian origin. J. F. Quack, 'Dekane und Gliedervergottung', examined this in relationship to the *Apocryphon of John* (see above, Chapter 5, 2.2). He suggests that astrological melothesia comes not only from Greek tradition, but from the Egyptian practice of 'deification of the limbs' (98). (See also idem, 'Dekane', §2.1.12 [§2.2.12 2014], which makes a few changes from the earlier article.) Decan melothesia is also discussed by von Lieven, 'Die dritte Reihe', 29–30.

111 See the discussion of which came first, zodiacal or decanal melothesia, in Quack, 'Dekane', §2.2.9 (§2.3.9 2014). As seen below, 3.3, 220, Origen, *Contra Celsum* 8, 58 attributes decan melothesia to the Egyptians.

112 Ruelle, 'Le Livre Sacré sur les Décans'. Discussion of this and the Testament of Solomon's decanal melothesia in G. Adamson, 'Astrological Medicine in Gnostic Traditions', in *Practicing Gnosis: Ritual, Magic, Theurgy and Liturgy in Nag Hammadi, Manichaean and Other Ancient Literature. Essays in Honor of Bürger A. Pearson*, ed. April D. De Conick, Gregory Shaw, and John D. Turner (Leiden/Boston: Brill, 2013), 238–42.

113 Nechepso and Petosiris, *Fragmenta magica*, ed. E. Riess, (Göttingen: 1892), 379 (= Firm. *Math.* IV, 22.2).

114 Kákosy, 'Decans', 164–75.

115 *Wb* I, 429–30; also Neugebauer and Parker, *EAT* III, 157, a text from Kom Ombo: 'the decanal stars (*bʒkw*) ...'.

convenient similarity for joining the two traditions). These characteristics will feature in later non-Egyptian texts which portray a symbiosis of god and daimon associated with decan lore.

3.3 *God or Daimon?*

In Hermetic texts and in Christian writers like Origen, as well as in Jewish-Christian texts like the *Testament of Solomon*, gods and daimons are both featured. For example, in *Contra Celsum* the decans (whose origin, Celsus says, are Egyptian) are explicitly called daimons:

... the Egyptians say that the body of man has been put under the charge of thirty-six daimons, or ethereal gods of some sort, who divide it between them, that being the number of parts into which it is divided (although some say far more). Each daimon is in charge of a different part.¹¹⁶

Recall that daimons are described partially as ‘from aether’ (ἐξ αἰθέρος) in the *Epinomis* (984e3) (see Chapter One, 1.4). In *CH XVI*, 10 and 13, what seems clearly to be a reference to decans¹¹⁷ speaks of ‘many choirs of daimons like diverse military companies, living with [mortals] though not far from the immortals...’¹¹⁸ The interesting juxtaposition of χορός, a word used metaphorically to describe astral movement as a dance (e.g. Plotinus, *Enneads*, IV, 4.33), with στρατεία (= στρατία), a military cohort or company,¹¹⁹ emphasises the combination of daimons as astral beings with daimons as *dekanoi*, also a military term.¹²⁰ Note also their intermediate position between gods and men, typical of daimons.

In another Hermetic text the power of the astral decans is displayed. *SH VI*, which is devoted to ‘the thirty-six decans’ (VI, 1), says they reside between the

116 Origen, *Contra Celsum*, 8.58.3–6 (Borret, IV, 306.3–6):... Αἰγύπτιοι λέγουσιν, ὅτι ἄρα τοῦ ἀνθρώπου τὸ σῶμα ἕξ καὶ τριάκοντα διειληφότες δαίμονες ἢ θεοὶ τινες αἰθέριοι εἰς τοσαύτα μέρη νενεμημένον—οἱ δὲ καὶ πολὺ πλείους λέγουσιν—ἄλλος ἄλλο τι αὐτοῦ νέμειν ἐπιτέτακται. Trans. H. Chadwick, in *Origen: Contra Celsum*, 496, slightly modified. This quotation refers to decanal melothesia.

117 See 210 and n. 65. This text may be linked to *SH VI*, which specifically deals with decans: see Festugière’s commentary on decans at Nock and Festugière, *CH III*, xxxviii–lxi.

118 *xvi*, 10.3–5, (Nock and Festugière, *CH II*, 235.12–14): καὶ γὰρ δαϊμόνων χοροὶ περὶ αὐτὸν πολλοὶ καὶ ποικίλαις στρατεῖαις εἰκότες οἱ... σύνοικοι καὶ τῶν ἀθανάτων οὐκ εἰσὶ πόρρω... .

119 Following the lead of Einarson in *app. crit.*, Nock and Festugière, *CH II*, 239, n. 28, reading στρατεῖαις for στρατίαις.

120 See Denningmann, *Doryphorie*, 185 and n. 536; and H. Behlmer-Loprieno, ‘Zu einigen koptischen Dämonen’, *GM 82* (1984): 7–23, here 7; also the commentary in Scott, ed. and trans., *Hermetica*, vol. II, 451.

outer circle of the cosmic spheres and the zodiac (VI, 3).¹²¹ In this location they are above the planets and exempt from their vagaries (VI, 6); they are called 'gods' (VI, 10), yet fundamentally considered to be 'careful guardians and overseers of the all',¹²² which makes them sound more like *daimons*, especially daimons in their administering and protective functions. The text also says that these decans create 'emanations' which can either save or destroy.¹²³ Here may be a conflation of the functions of god and daimon, where the gods hold the customary daimonic function of guarding and protecting, while the daimons carry out the will of the decan gods.

These daimons are not exactly material, nor are they 'moved by soul', but are called 'energies of these thirty-six gods'.¹²⁴ The *heimarmenē* described in Ps.-Plutarch's *De fato* is both *energeia* and *ousia* (see Chapter One, 2.1). As *energeia*, 'actuality', it is what fate does, the actions it brings about. The daimons created from the decans, then, are '*energeiai*', actualities brought about by the decan gods; (Plotinus also talks about daimons in terms of *energeia*: *Enneads* III, 4.3). This *energeia* unleashed by the decans in daimonic form is responsible for collective 'workings' which include both natural and political disasters (VI, 7–9). Not for the first time, daimons and fate are connected, here by the medium of *energeia*. In this same text we also see the stars associated with decans which are called '*leitourgoi*', ministers, again evoking the daimonic function of ministering to human beings.¹²⁵

Asclepius 19 provides a cosmology of both intelligible and sensible gods. The intelligible gods rule over the sensible gods, which include the '36 called Hour-markers, that is, the stars fixed in the same place';¹²⁶ their intelligible god, i.e. 'lord of existence' (*ousiarchēs*) is called 'Παντόμορφον or Omniform'.¹²⁷ The '36' are clearly the decans described in *SH* VI. *Pantomorphos* is said to make

121 'Under the circle of this body [i.e. the cosmos] are placed the thirty-six decans, midway between the circle of all [and] the zodiacal circle . . . : Ὑπὸ δὲ τὸν κύκλον τοῦ σώματος τούτου τετάχθαι τοὺς τριάκοντα ἕξ δεκανοὺς, μέσους τοῦ παντὸς κύκλου <καὶ> τοῦ ζωδιακοῦ . . . (Nock and Festugière, *CH* III, 34–35). A strangely similar description is given by Neugebauer and Parker, *EAT* III, 73, about the Dendera decan/zodiac ceiling: 'The decans are at the perimeter of the circular sky, and between them and the pole is the circle of the zodiac, askew as we should expect and not centered at the pole.'

122 VI, 6.6–7 (Nock and Festugière, *CH* III, 35): . . . φύλακες ἀκριβεῖς καὶ ἐπίσκοποι τοῦ παντὸς.

123 VI, 11.3, *ibid.*, III, 36: . . . τάνας, τὰς μὲν σωτηρίους, τὰς δὲ ὀλετριωτάτας.

124 VI, 10.6, *ibid.*, III, 36: . . . ἐνέργειαι εἰσι τῶν τριάκοντα ἕξ τούτων θεῶν.

125 *SH* VI.12. See Chapter 7, 251 for more on *leitourgoi* in astrological and Hermetic texts.

126 *Asclepius* 19 (Nock and Festugière, *CH* II, 319.1–3): ἄλλο μὲν ἑκάστου ὁροσκοπίου, ἰδὲ ἐκείνου τοῦ αὐτοῦ ὁροσκοπίου, ἰδὲ ἐκείνου τοῦ αὐτοῦ ὁροσκοπίου . . . (See translations of Scott, *Hermetica* I, 324; Copenhaver, *Hermetica*, 78.)

127 *Asclepius* 19 (Nock and Festugière, *CH* II, 319.4): Παντόμορφον (vel Omniformem) . . .

'different forms for different kinds'.¹²⁸ In fact, the decanic deities themselves do consist of many different kinds of deities in many different shapes. These come from the Egyptian tradition, and are not the same as the gods of the decanic faces, which are planets assigned in Chaldean order to each 10-degree segment of a zodiac sign. There seem to be two traditions here, both of which become established in astrological lore.

The Jewish-Christian *Testament of Solomon* (introduced in Chapter 4, 1.4, 132–34) shows angels and demons working together: demons controlled by archangels are compelled to help build the temple (do we thus see bad daimons making good?). The *Testament* also makes an overt connection between decans and daimons. In Chapter 18, Solomon calls up the demons of the decans, who explicitly cause illness. As each demon is summoned, it tells Solomon which diseases it rules over, correlated with zodiac signs,¹²⁹ and how it can be banished by an archangel; so along with the assignment of each demon to an illness, we are given the name of the archangel who can dispel it. It seems clear that the association of decans/demons with illness comes from the Egyptian tradition.

Numerous similarities are apparent here with the Egyptian concepts delineated in 3.2 above. Egyptian fingerprints mark the kind of genealogy that we see both in the *SH VI*, where the decan gods create daimons, and in *Asclepius* 19, where the god of many forms creates daimons of many forms. Conflations of Egyptian, Hermetic and astrological material affect the way the decans are represented.

In the transfer of Egyptian decan lore to the practice of Hellenistic astrology, all these components are retained. The decans are associated both with divinities who are daimon-like, and with gods. An amalgamation takes place between the concept of a god who protects or avenges, and a messenger who carries out the wishes of the god. Possibly this interplay between god and daimon also accounts for the two traditions that we see in astrological decan doctrine—that of, on the one hand, decans representing Egyptian daimonic deities and, on the other hand, decans representing planets-as-gods.¹³⁰

128 Ibid. (Nock and Festugière, *CH II*, 319.4–5): '... diversis speciebus diversas formas facit'. Copenhaver, *Hermetica*, 78. The Omniform is mentioned again in *Asclepius* 35.

129 See Busch, *Das Testament Salomos*, 223–29, whose translation and commentary uses recensions that incorporate the zodiac signs. Duling's translation in Charlesworth, *The Old Testament Pseudepigrapha*, vol. 1, does not.

130 In the Medieval period, talismans were made when the Sun was in each of the decans/faces: see Pseudo-Ptolemy, *De imaginibus super facies signorum*, in L. Thorndike, 'Traditional Medieval Tracts Concerning Engraved Astrological Images', in *Mélanges Auguste Pelzer*,

4 Gods and Daimons in Astrological Decans

Astrological texts do not, as a rule, explicitly describe decans as daimons, but we have now seen many instances of correspondence between decans and daimonic entities.¹³¹ (Planetary) gods appear in the system of decanic faces. There are three different systems of decans within Hellenistic astrology, two of which explicitly use gods and daimonic entities. One system employs patently Egyptian names for each decan; these appear, at this stage of historical development, to be less godly and more daimonic in their functions. This version of decans is often associated with disease and its cures. Another system assigns a planet to rule over each third of a zodiacal sign; these are called ‘faces’ (πρόσωπα in Greek, *facies* in Latin), and get incorporated into the dignity system as the fifth dignity in Medieval astrology. A third system, seemingly based on triplicities, may have been transferred to India and thence to the Arabic astrologers.¹³²

I shall discuss these systems by exploring representative texts and artefacts. I note at the outset, however, that neither Ptolemy nor Vettius Valens mentions decans, though both refer to ‘faces’ of the stars. Ptolemy’s face doctrine is different than the decanic faces described by other authors.¹³³ Valens uses the same term, ‘in its own face’, as Ptolemy, though it is difficult to determine sometimes whether he means decanic face or Ptolemy’s definition.¹³⁴ We shall begin with presumably the oldest astrological text mentioning decans, the *Salmeschiniaka*.

Université de Louvain. Recueil de travaux d'histoire et de philologie, 3.sér., 26. fasc (Louvain: Bibliothèque de l'Université, Bureaux du 'Recueil', 1947), 256 (a German translation in Gundel, *Dekane*, 394–401). See also C. Burnett, *Magic and Divination in the Middle Ages: Texts and Techniques in the Islamic and Christian Worlds* (Aldershot: Variorum, 1996), Chapter IX (The Conte de Sarzana Magical Manuscript), 3; Liber Ptolemaei de impressionibus imaginum annullorum et signorum secundum facies duodecim figurarum zodiaci.

- 131 Bouché-Leclercq, *AG*, e.g., 220–21, in his descriptions of the Egyptian decans and their relationship to astrology, continually calls them ‘génies’.
- 132 D. Pingree, ed., *Yavanajātaka*, II, 209–10, describes this system as used by the Indians.
- 133 For Ptolemy (*Tetrabiblos* I, 23), a planet is ‘in its own face’ if it is in the same relationship to the sun or moon that its own planetary house has to the Sun’s or Moon’s house. Cf. the same in Al-Qabīṣī, *The Introduction to Astrology*, ed. and trans. Charles Burnett, Keiji Yamamoto, and Michio Yano (London/Turin: The Warburg Institute—Nino Aragno Editore, 2004), 93 (chapter 3, 5).
- 134 See Valens II, 5.1; II, 6.1 with the parallel constructions for malefics in the twelfth and benefics in the eleventh, which suggest the Ptolemaic definition; also II, 12.2; II, 14.1. In these cases, ‘in its own face’ seems to mean something similar to a planet ‘in its own place’ (e.g. Moon in the 3rd or Mars in the 6th), a relationship based on where a planet happens to fall spatially, not on what sign, or part of a sign, it is in. But II, 10, which refers

4.1 *The Salmeschiniaka*

This document, existing only in descriptions by later authors, may date to the third century BCE,¹³⁵ and is likely one of the oldest that we have concerning decans in astrology.¹³⁶ Three Greek texts mention it: Porphyry's *Letter to Anebo*, Iamblichus's response to the Letter in *De mysteriis* and Hephaestio of Thebes.¹³⁷ All three sources mention the decans as a part of the *Salmeschiniaka*. The *Letter to Anebo* names the decans in company with the 'horoscopes' and the 'mighty rulers':

For Chaeremon and the others do not hold that there is anything prior to the visible worlds, placing first in order the gods of the Egyptians, and that there are no other gods except the so-called planets, and the stars that fill up the zodiac and those which co-rise with these; and both the divisions into decans and the Hour-markers, and so-called mighty leaders, whose names are also contained in the *Salmeschiniaka* along with their curing of diseases and their risings and settings and indications of future events.¹³⁸

to Mercury and the malefics being 'in its [their] own face[s] (11, 10.2, 3; ἰδιοπροσωπέω), is followed by a reference to malefics being in 'another's face' (11, 10.4; ἀλλοιοπροσωπέω), which does suggest decanic face; see also the ambiguous VII, 2.23.

135 Cramer, *Astrology in Roman Law and Politics*, 19, n. 150; see also Gundel's stemma in Gundel, *Dekane*, 92–93. Quack, 'Dekane', §2.2.5 (§2.3.5 2014), mentions Chaeremon as a *terminus ante quem*, and (cautiously) possibly an Egyptian original in the Saite period.

136 Some scholars have made a connection between it and P. Oxy. 465, Greek papyrus fragments which describe the gods assigned to different parts of the month and zodiac sign, and their effects, including events and illnesses: see B. P. Grenfell and A. S. Hunt, *The Oxyrhynchus Papyri. Part III* (London: Kegan Paul, 1903), 127–28; R. Eisler, *The Royal Art of Astrology* (London: Herbert Joseph Limited, 1946), 128, 131–33; G. Adamson, 'The Old Gods of Egypt in Lost Hermetica and Early Sethianism', in *Histories of the Hidden God: Concealment and Revelation in Western Gnostic, Esoteric, and Mystical Traditions*, ed. April D. DeConick and Grant Adamson (Durham: Acumen Publishing Limited, 2013), 65–66. The word 'decan' is not used in the fragments, however. D. Pingree, 'The Indian Iconography of the Decans and Horâs', *Journal of the Warburg and Courtauld Institutes* 26, no. 3/4 (1963): 223–54, here 228, is skeptical of a connection, as am I. Quack, 'Dekane', §2.2.2.5 (2.3.5 2014), in a detailed examination, also concludes that P. Oxy. 465 is not related to the *Salmeschiniaka* (see also idem, 'Naos of the Decades', 178).

137 See below, 4.6, 230, for Hephaestio's text on decans in the *Salmeschiniaka*.

138 *Letter to Anebo*, 2.12b (Sodano [= PE III, 4.1]): «Χαιρήμων μὲν γὰρ καὶ οἱ ἄλλοι οὐδ' ἄλλο τι πρὸ τῶν ὀρωμένων κόσμων ἡγοῦνται, ἐν ἀρχῆς λόγῳ τιθέμενοι τοὺς Αἰγυπτίων, οὐδ' ἄλλους θεοὺς πλὴν τῶν πλανητῶν λεγομένων καὶ τῶν συμπληρούντων τὸν ζῳδιακὸν καὶ ὅσοι τοῦτοις παρανατέλλουσιν, τὰς τε εἰς τοὺς δεκανοὺς τομὰς καὶ τοὺς ὠροσκόπους καὶ τοὺς λεγομένους

Here, condensed in one short paragraph, is much of the received decan doctrine. There are echoes of Hermetic texts as well as the linking of decans with ‘horoscopes’ (as a portion, i.e. degree, of the decan).¹³⁹ Here, too, is the tradition of decans associated with disease; the way they are interpreted is dependent on their risings and settings (a standard way of explaining their effects).

4.2 *Manilius*

As with a number of his other doctrines, Manilius’s system of decans is unique.¹⁴⁰

TABLE 6.1 *Manilius’s system of decans*

Sign	Decan			Sign	Decan			Sign	Decan		
	1	2	3		1	2	3		1	2	3
♈	♈	♉	♊	♌	♈	♉	♊	♍	♈	♉	♊
♉	♌	♍	♎	♎	♌	♍	♎	♏	♌	♍	♎
♊	♍	♎	♏	♏	♍	♎	♏	♐	♍	♎	♏
♌	♏	♐	♑	♐	♏	♐	♑	♒	♏	♐	♑

Rather than assigning each decan to a god or Egyptian divinity, he distributes (*tribuo*)¹⁴¹ each third of a sign to another sign, beginning in Aries with Aries and going in sign order. By the time he reaches Leo, the series begins again; and again at Sagittarius. This has the effect of all the fire signs having the same signs (Aries, Taurus, Gemini) for their decans (signs of the same element begin each decan series, so each fire sign’s first decan is given to a fire sign). The same happens for the air signs: the first decan of each is an air sign (Libra), followed by Scorpio and Sagittarius. The earth and water signs exchange elements (i.e., the

κραταιοὺς ἡγεμόνας, ὧν καὶ τὰ ὀνόματα ἐν τοῖς Σαλμεσχινιακοῖς φέρεται καὶ θεραπείαι παθῶν καὶ ἀνατολαὶ καὶ δύσεις καὶ μελλόντων σημειώσεις.»

139 As in *Asclepius* 19 (see above, 3.3, 221–22) and the extant chart of 95 CE (see *GH*, 30–31, and below, 234–35). Galen, too, in *De simpl. medicam. temperam. ac facult.* VII (Kühn, XI, 789–892) (as cited in Gundel, *Dekane*, 345), refers to ‘sacred plants of the decans and daimons’, and the ‘36 sacred plants of the Horoskopoi’ (797.9–10: ... καὶ δεκανῶν καὶ δαιμόνων ἱεράς βοτάνας ...; 798.5–6: ... τὰς λστ’ τῶν ὠροσκόπων ἱεράς βοτάνας ...).

140 See Bouché-Leclercq, *AG*, 217–19. Bouché-Leclercq says that Manilius is the first to use the word *decanus* in relation to astrology (221).

141 4.301–302: et tribuunt denas in se coeuntibus astris / inque vicem ternis habitantur sidera signis.

first decan of each water sign is Capricorn, while the first decan of each earth sign is Cancer).¹⁴² There is a *de facto*, if not intentional, employment of triplicities and elements here. By using this system of decans Manilius seems to be trying to account for differences in form and character (*mores*) which arise among people born with the same ascending sign.¹⁴³ In fact, Manilius uses the word *mores* several times as he describes the effects of each decan (4.371, 4.375 and 4.408). He follows his description of decans by referring to the laws of fate and destiny which can be seen in decan interpretation and in the interpretation of single degrees (e.g. 4.378–379, 436–438). Though this is the only explicit mention of decans, Book 5 deals with *paranattellonta* (associated with decans by Teucer), and may thus have an unarticulated decanic component.

4.3 *Teucer and Antiochus*

Two texts on decans are ascribed to Teucer of Babylon.¹⁴⁴ Both mention constellations that co-rise with the decans (*paranattellonta*). One also includes co-risings of the *dodekaoros* with the decans (CCAG VII, 194–213). Such links, of course, betray Egyptian roots.¹⁴⁵

Teucer may be the first astrologer to use both Egyptian-style decans and decanic faces.¹⁴⁶ The doctrine of decanic faces also appears in the *Thesaurus* of

142 This system has similarities with the Indian system (see n. 132) which we see in Arabic astrology (see Al-Qabīṣī, *Al-Qabīṣī Introduction*, 130–31, ch. 4.18): the decans in each triplicity take as their associates the rulers of the fifth and ninth signs from them (which is what effectively happens in Manilius). But the Arabic and Indian versions use planets, not signs, as rulers.

143 This is akin in flavour to Porphyry's astrological version of incarnation in *What is Up to Us*, attempting to account for variations in character by varying the astrological possibilities.

144 Text I: Boll, *Sphaera*, 16–21; W. Hübner, *Grade und Gradbezirke der Tierkreiszeichen*, 2 vols., vol. I, Edition, vol. II, Kommentar (Stuttgart/Leipzig: B. G. Teubner, 1995), I, 126–27 (partial); CCAG VII, 194–213 (Rhetorius quoting Teucer on the twelve signs, including decans). Text II: Boll, *Sphaera*, 41–52; Hübner, *Grade und Gradbezirke*, I, 108–25.

145 See J. F. Quack, 'Frühe ägyptische Vorläufer der Paranattellonta?' *SA* 83 (1999): 212–23; A. von Lieven, "'The Soul of the Sun Permeates the Whole World.'" *Sun Cult and Religious Astronomy in Ancient Egypt*, *Pandanus '10* 4, no. 2 (2010): 29–60, here 33, 42–44.

146 See Rhetorius's excerpt of Teucer on the twelve signs, including decans and *paranattellonta*, and decanic faces, CCAG VII, 194–213. Chapter 47 of Porphyry's *Introduction to the Tetrabiblos*, inserted by Demophilus (see D. Pingree, 'From Alexandria to Baghdād to Byzantium. The Transmission of Astrology', *IJCT* 8, no. 1 (2001): 3–37, here 7–8), ends by ascribing decans, their *paranattellonta* and the decanic faces to Teucer of Babylon. See Gundel, *Dekane*, 416–17; also Bouché-Leclercq, *AG*, 224–25. In 225, n. 1, (carried over to 226), he says that the faces 'disguise' the decans in planetary form.

Antiochus, Chapter 10 (copied by Rhetorius);¹⁴⁷ a fragment ascribed to Teucer follows which gives interpretations for each of the decans in the signs.¹⁴⁸ The descriptions read as if the author intends to link the decan with the Ascendant, though this is not explicitly stated: the general idea conveyed is that if someone is born (or an event happens) with the Ascendant in a given decan, a particular outcome ensues. Like Manilius, it seems Teucer, via Antiochus/Rhetorius, is trying to account astrologically, via the decans, for differences in character and life experiences.

These early (relatively speaking) texts linking character to the decans, especially the rising decans with the Ascendant degree, again suggest a foundation for the Ascendant, a.k.a. *hōroskopos*, in the rising decan which represents a particular style of character. The Ascendant and first place are traditionally important in astrology for determining character and temperament (e.g., see Ptolemy, *Tetrabiblos*, III, 11).

4.4 *Anubio and Julius Firmicus Maternus*

Decans are called ‘hour-regulators’ (ὠρονόμοι) as well as λειτουργοί in Anubio, the (probably) late first century CE elegiac poet and astrologer.¹⁴⁹ These terms match those in Hermetic texts. I present Anubio with Firmicus because he quotes Anubio on decans in II, 4.1 (the division of each sign into three decans which control it) and II, 4.4–5 (the further division of each decan into three

147 *CCAG* I, 149–50 refers to the same text as chapter 47 of Porphyry’s *Introduction to the Tetrabiblos*. (Part of this is also quoted in Scholion 9 to Paulus [Boer, 104–05]; see below 4.5, 229 and n. 157.)

148 *CCAG* I, 150–51. An example, *CCAG* I, 151.3–6: ‘One who is born in the 1st decan of Sagittarius will not take care in [choosing] a wife and will be distressed about his children; in the 2nd [decan] he will live a painless life, except he will end it among foreigners; in the 3rd it makes those who are rich and esteemed, and he will receive an inheritance from a woman.’ Δεκανῶ α’ Τοξότου ὁ γεννηθεὶς οὐκ ἐπιτηδεύσει ἐν γυναιξὶ καὶ ἐπὶ τέκνοις λυπηθήσεται· ἐν δὲ τῷ β’ ἄλυπον βίον ζήσεται, πλὴν ἐπὶ ξένοις τελευτήσεται· ἐν δὲ τῷ γ’ πλουσίους καὶ ἐνδόξους ποιεῖ καὶ κληρονομίαν λήψεται ἐκ γυναικός.

149 Frs 1 and 2 (Obbink, 23–25). I use Obbink’s English term, ‘hour-regulator’. The same in Anubio, *Anoubion, Elegiacs*, ed. and trans. Dirk Obbink (London: Egypt Exploration Society, 1999), here 75 [Front fr. 2]; see also R. Beck, ‘Review: Dirk Obbink (ed.), Anubio, Carmen astrologicum elegiacum’, *Bryn Mawr Classical Review* 2007.9.28 (2007), <http://ccat.sas.upenn.edu/bmcr/2007/2007-09-28.html>. In fact, in direct quotation Anubio does not even use forms of ὠροσκόπος, only forms of ὠρονόμος. We find this same term used consistently for the Ascendant in Manetho the astrologer, e.g. I, 30, 58, 262, 339, 347; the Greek fragments of Dorotheus as well favour this term. Since all these authors are 1st or early 2nd century CE, perhaps this usage reflects the transition of decans which ‘regulate’ hours to Ascendants which ‘mark’ them. See Greenbaum and Ross, ‘The Role of Egypt’.

munifices, i.e. *liturgi*—his choice of words—making nine per sign, who rule over illness and sudden accidents).

Firmicus's interest in decans and their influence is seen in Books II and IV.¹⁵⁰ In II, 4 he actually describes decanic faces, though he does not use the word *facies*: planets are assigned to the three decans of each sign, beginning with Aries, in Chaldean order. There is no interpretation in Book II, but in IV, 22 he tackles the thorny subject of full and empty degrees as applied to the decans within signs.¹⁵¹ These are important for astrological medicine, a significant piece of decanic doctrine, as we have seen. Here he deals with the Egyptian decans which have the ability to cause and cure disease (a power not given to the decanic faces, or at least not mentioned by Firmicus). Firmicus tells us that 'the decans themselves are possessed of great divine assent (*numen*) and power, and through them all prosperity and all misfortune are decreed' (IV, 22.2).¹⁵² This is a strong statement, and Firmicus goes on to explain that, according to Nechepso, the decans predict illness and, in knowing how the decans work, cures can be found.¹⁵³ But the *numen* of the decans does not extend to every degree, requiring a list of each sign with its full and empty degrees. Better outcomes occur for those with more planets and the Ascendant in full degrees. As Firmicus interprets them, the full degrees provide vitality and prosperity, while the empty degrees do not. Specific illnesses are not mentioned. Unlike Manilius, Firmicus's focus is on the decans' ability to give health or illness, as well as happiness and depression, not as predictors of character.

The use of the word *numen* here is interesting, because this word links with both gods and daimons. Herbert Rose associates *numen* with activity (i.e. *energeia*),¹⁵⁴ even though he is speaking of the earliest connotations of *numen* and daimons; as we have seen earlier, this is an attribute also of daimons in the Hermetic and magical texts. Rose also discusses *potestas*, an analogue of *δύναμις*, as something possessed by daimons. I am not suggesting that Classical Greek and Roman conceptions of daimonic power as described by Rose are strictly applicable in late antiquity to what Firmicus says, but I do want to stress that the power described here can be both godly and daimonic. In the

150 For an analysis of Firmicus's use of the decans, and comparisons with other texts, see Abry, 'Les décans chez Firmicus Maternus', 197–228.

151 For full and empty degrees associated with Egyptian decans, see Leitz, *Altägyptische Sternuhren*, 47–49; Quack, 'Dekane', §2.2.8 (§2.3.8 2014).

152 (KSZ I, 264.24–26 = Monat, II, 202): ... sunt autem decani ipsi magni numinis et potestatis et per ipsos omnia prospera et omnia infortunia decernuntur.

153 IV, 22.2 (KSZ I, 265.1–8 = Monat, II, 202).

154 H. J. Rose, 'Nvmen inest: "Animism" in Greek and Roman Religion', *HThR* 28, no. 4 (1935): 237–57, here 241, 243.

same way, Rose also says that sometimes θεός and δαίμων are interchangeable in Homer, not because they are equivalent, but because they cannot always be defined.¹⁵⁵ The same thing happens with Firmicus's use of the words *numen* and *potestas*. They are properties of both gods and daimons.

4.5 *Paulus Alexandrinus*

Paulus makes no mention of the Egyptian-style decans, but only decanic faces. However, he does make an interesting comment on how the faces come about: 'As for the faces of the seven stars from the *decanic shaping* by zodiac sign, in which they rejoice as if in their own dwelling places, it will be necessary to arrange them in order according to the seven-zone system . . .'.¹⁵⁶ This seems to imply that the faces have arisen out of the decans, and are a later addition to decan doctrine.¹⁵⁷

4.6 *Hephaestio of Thebes*

Book 1 of the *Apotelesmatika* contains long descriptions and delineations of the Egyptian decans. Faces are not mentioned. Hephaestio describes the three decans for each sign, giving clearly Egyptian-derived names. He explicitly states that their delineations apply to the decan rising at birth (e.g. 'the first decan marking the hour'¹⁵⁸), thus linking the importance of the Ascendant with its associated decan. The delineations cover physical appearance, happiness and grief during life, character descriptions and whether the circumstances at death are good or bad. Critical years are also given for the decan rising in the sign. Hephaestio occasionally refers to a decan as a god. We find in Hephaestio the longest and most detailed descriptions of the actions of decans by any Hellenistic astrologer.

155 Ibid., 247: '... we must remember two things. One is that a god, who is certainly a personal being, is often called a δαίμων, and the gods in general δαίμονες, suggesting that to Homer the word did not mean an impersonal power but rather one either undefined by him or impossible to be defined by anyone; which is very different from saying that it is by nature indefinite.'

156 My italics. Chapter 4 (Boer, 15.4–7): Τὰ δὲ κατὰ ζώδιον ἐκ τῆς δεκανικῆς διαμορφώσεως τῶν ἑπτὰ ἀστέρων πρόσωπα, ἐν οἷς χαίρουσιν ὡσπερ ἐπὶ τῶν ἰδίων οἰκητηρίων, πραγματεύεσθαι δεήσει τάξει τῆ κατὰ τὴν ἑπτάζωνον . . .

157 Scholion 9 to this chapter (Boer, 104.18–105.10) contains almost verbatim the words ascribed to Antiochus in Chapter 10 of the *Thesaurus*, which lays out the faces for each decan of Aries according to Chaldean order (the 'seven-zone system' referred to). The last sentence of the scholion refers to the decans themselves and their *paranatellonta*.

158 Hephaestio I, 1.13 (Pingree, 1, 5.14–15):... τοὺς μὲν ἔχοντας ὠροσκοποῦντα τὸν πρῶτον δεκανὸν . . . , et sim.

In Book II, 18, where Hephaestio describes the writings of Antigonus of Nicaea, complete with example charts, he refers to the *Salmeschoiniaka* and its contents on decans:

And collecting material from books of the *Salmeschoiniaka*, he [Antigonus] speaks, as it is there, in this way: one must also observe the decans, since the first, that of the Hour-marker,¹⁵⁹ is operative for childbirth, but the 28th decan from it, which culminates in the forenoon, is operative for manner of living; but the 25th, which culminates at midday, is operative for bad health; but the 9th, which rises late in the east wind, is operative for injuries; but the 17th, which rises in the west wind, is operative for marriage and wives; but the 8th, door of Hades, is operative for children, and the one in the Underground is operative for death. These are the places which the ancient Egyptians use for every nativity. Therefore let so many be set out for soul, and manner of living, and prosperity. . . .¹⁶⁰

Again, the decans correlate with life events rather than specifically with illness. But even though they are somewhat correlated to the astrological places, the decans here are described mostly in terms of their rising, culminating and setting; in other words, temporally and in terms of the daily cycle, rather than zodiacal placement.¹⁶¹ This evidence again supports Egyptian influence on their use in astrology. The Egyptian connection is further cemented by the reference to winds in which the decans rise: for example, the decans are moved by Shu, god of air and winds, on the Naos of the Decades.¹⁶² The events connected to the decanal places are somewhat unorthodox. Some do correspond generally to their later astrological place, e.g. the ‘west’ for marriage and wives = the seventh place, and the Underground = death. But perhaps the decans as described

159 Epite IV, 26.65 (Pingree, 2, 233.5), has ὁ μὲν α' ὠροσκοπῶν instead of ὁ μὲν πρῶτος τοῦ ὠροσκοπού, so the sense intended may be ‘the first decan marking the hour’, emphasising the *decan* rather than the rising degree (the Ascendant).

160 II, 18.74–77 (Pingree, 1, 167.1–13): Καὶ ἐκ τῶν Σαλμεσχοινιακῶν δὲ βιβλίων ἀναλεξάμενος ὡς ἔστιν ἐκεῖ οὕτως λέγει. σκοπητέον δὲ καὶ τοὺς δεκανοὺς ἐπειδὴ περὶ ὁ μὲν πρῶτος τοῦ ὠροσκοπού χρηματίζει περὶ τοκετοῦ, ὁ δὲ ἀπὸ τούτου δεκανὸς κη', ὃς μεσουρανεῖ πρωτῶ, χρηματίζει περὶ βίου, ὁ δὲ κε', ὃς μεσουρανεῖ μεσημβρίαν, χρηματίζει περὶ ἀρρωστίας, ὁ δὲ <ι>θ', ὃς ἀνατέλλει ἐν τῷ ἀπηνλιώτῃ ὀψέ, χρηματίζει περὶ σίνους, ὁ δὲ ιζ', ὃς ἀνατέλλει ἐν τοῖς λιβυκοῖς, χρηματίζει περὶ γάμου καὶ γυναικῶν, ὁ δὲ η', Ἄιδου θύρα, χρηματίζει περὶ τέκνων, ὁ δὲ ἐν τῷ ὑπὸ γῆν χρηματίζει περὶ θανάτου. οὗτοί εἰσιν οἱ τόποι οἷς χρωῶνται ἐπὶ πάσης γενέσεως οἱ παλαιοὶ Αἰγύπτιοι. τοσαῦτα μὲν οὖν ἐκκείσθω περὶ ψυχῆς καὶ βίου καὶ προκοπῆς . . .

161 Pingree, *Yavanajātaka*, II, 219, suggests a connection of the decans with ages of life, but I do not see a strong connection with them in this passage.

162 Bomhard, *Naos of the Decades*, 39–42, 95.

here were not meant to be correlated to standard astrological places; they are remnants of an earlier Egyptian system which assigned these particular life events to the decans as they rose, culminated, set and anti-culminated. This would account for the insertion of winds. Wilhelm Gundel links this passage to another text of the Arabic era where each decan is linked, not to a third of a zodiac sign, but to a third (ten degrees) of a place.¹⁶³ But this text is different from Hephaestio's description of the *Salmeschiniaka's* contents, in that it appears to be a conflation of traditional place characteristics with the decans, ascribing to each of the three decans in the place one of the place's attributes. For example: 'The first decan of the 11th place signifies friends, the 2nd good fortune, the third hope and children.'¹⁶⁴ To my knowledge this technique does not appear in Hellenistic astrological authors.

4.7 *The Liber Hermetis*

In the *Liber Hermetis* we find Egyptian decans combined with faces, not separated in different books as in Firmicus. Since much of the *Liber Hermetis* is a compilation of various authors and techniques, this is not surprising. But the *Liber Hermetis* is exceptional among Hellenistic texts in the way it describes the decans and faces.¹⁶⁵ To take just one example:

On the second face of Aries. The second decan has the face of the Sun. His name is Sabaoth, and he has a two-headed face and a lotus of the kings open on his head. Circling around the lotus are stars with the splendor of gold. He also holds a water jug which is called life in his right hand, in his left a scepter, the end of which is split in two. The decan himself is clothed in linen and under both feet he treads on a tortoise totally covered with a net. He rules over the region of the Bactrians.¹⁶⁶

163 Gundel, *Dekane*, 410, did not identify its Arabic origin. He gives a German translation (but no Greek). The text, in the 14th century manuscript Vat. gr. 1056, fols 194–221, here 219v–220, is a Greek version of the *Mudhākarāt* of Shādhān, a student of Abū Ma'shar (see D. Pingree, 'Classical and Byzantine Astrology in Sassanian Persia', *DOP* 43 (1989): 227–39, here 227, n. 2). Pingree prepared an edition of this text, but it is unpublished. I thank Charles Burnett for this information. I have now examined the relevant folia.

164 Vat. gr. 1056, f. 220.5–6: ὁ <πρῶτος δε>κανὸς τοῦ ια' τόπου σημαίνει περὶ φίλων· ὁ β' περὶ εὐτυχίας· ὁ δὲ τρίτου περὶ ἐλπίδος καὶ τέκνων.) The hand is very difficult. With thanks to Stephan Heilen for the ms. page and palaeographical advice.

165 Indian descriptions of the decans follow this format, however; see Pingree, *Yavanajātaka*, ch. 3, and commentary, II, 252; also, for their Egyptian roots, Pingree, 'The Indian Iconography of the Decans and Horās', 227–28, 249–52.

166 I, 5.25–32 (Feraboli, 4): De secunda facie Arietis. Secundus decanus habet faciem Solis. Nomen est ei Sabaoth, habens faciem ancipitris et lotum regium in capite apertum.

Here we see the combined effects of the decan god, Sabaoth, and the planetary decanic face, the Sun. In Hephaestio, the second decan of Aries is called Chontachre, and in Firmicus Senacher, relating to the original Egyptian. But the *Liber Hermetis* falls back on a Gnostic name, Sabaoth (which is usually linked to Mars, not the Sun), though references to the lotus and linen show its Egyptian roots. It is interesting that the *Liber Hermetis* descriptions do not give any delineation relevant to a person who has that decan rising at birth, but merely describe the decan deity. Though Chapter 1 is devoted to the decans, they are otherwise mentioned only in Chapter 16, which lists them as part of the considerations before judgement (these also occur in Rhetorius).¹⁶⁷ Here a distinction is made between the decans in relation to planets and co-rising fixed stars (according to Teucer) and the decanic faces and bright degrees of the signs.¹⁶⁸ By this time the two decanic doctrines were well-separated, and both were used in interpretation.

4.8 *Decans in Cosmas of Jerusalem*

Cosmas, an eighth-century bishop and hymn-writer, ascribes the hierarchy of gods and daimons in astrology to the Zoroastrians ('Zarathustra').¹⁶⁹ He writes of the '36 airs' into which the zodiacal circle is divided, clearly a reference to decans.

In circuitu quidem loti sunt stellae splendoris auri; tenet etiam in dextra hydriam, quae vocatur vita, in sinistra vero sceptrum, in cuius extremitate stat ancipiter. Decanus vero ipse est linteis indutus et sub utrisque pedibus calcat testudinem totam indutam rete. Hic dominatur climati Bactrianorum.

167 See *CCAG VIII/4*, 118–24.

168 XVI, 27.107–110 (Feraboli, 57): In qualibet quidem nativitate oportet quaerere significationes decanorum ad planetas et stellas fixas quae oriuntur cum eis secundum Teucrum Babylonium, facies eorum et terminos lucidos signorum. This is put slightly differently in Rhetorius (*CCAG VIII/4*, 124.14–17): καθ' ἐκάστην γένεσιν δέον ζητεῖν καὶ τὰ ἀποτελέσματα τῶν δεκανῶν πρὸς τοὺς ἀστέρας καὶ τοὺς παρανατέλλοντας καὶ τὰ πρόσωπα τῶν δεκανῶν καὶ τὴν λαμπρομοιρίαν τῶν ζῳδίων. 'For each nativity one must also seek the outcomes of the decans in relation to the stars and those [constellations] co-rising [with them], and the faces of the decans and the degree-brightness of the zodiac signs.' Is this a remnant of decans as 'bright horoscopes'?

169 *CCAG VIII/3*, 120. Though Bidez and Cumont support the Zoroastrian connection (J. Bidez and F. Cumont, *Les mages hellénisés*, I, 175–78; II, 273–74), de Jong, *Traditions of the Magi*, 266, disagrees about an Iranian influence. *Contra* Bidez and Cumont also see J. F. Quack, 'Les Mages Égyptianisés? Remarks on Some Surprising Points in Supposedly Magusean Texts', *JNES* 65, no. 4 (2006): 267–82.

Of the divisions into 36 airs they say the names of the gods are thus: Aidoneus, Persephone, Eros, Charis, Horai, Litai, Tethys, Cybele, Praxidike, Nike, Herakles, Hecate, Hephaestus, Isis, Sarapis, Themis, the Moirai, Hestia, Erinys, Kairos, Nemesis, Nymphai, Leto, Kairos,¹⁷⁰ Loimos, Korē, Ananke, Asclepius, Hygeia, Tolma, Dikē, Phobos, Osiris, Oceanos, Dolos, Elpis—apart from whom they say there are sixty others, and from these come the unlimited motion of the life-bearing circle and the planets.¹⁷¹

Their sign correspondence is:¹⁷²

Aries: Hades, Persephone, Eros
 Taurus: Charis, the Horai (Hours), the Litai (Goddesses of Prayers)
 Gemini: Tethys, Cybele, Praxidike (goddess who exacts justice)
 Cancer: Nike, Heracles, Hecate
 Leo: Hephaestus, Isis, Sarapis
 Virgo: Themis, the Moirai, Hestia
 Libra: Erinys, Kairos, Nemesis
 Scorpio: Kairos, Leto, Nymphai
 Sagittarius: Ananke, Kore, Loimos (Plague)
 Capricorn: Tolma (Daring), Hygeia, Asclepius
 Aquarius: Osiris, Phobos, Dike
 Pisces: Elpis (Hope), Dolos (Treachery), Oceanus

The use of the word ‘air’ implies daimons as creatures of air (as in the *Epinomis* and the *Chaldean Oracles*). The zodiac and planets have ‘unlimited motion’ (is this connected somehow with the *energeia* of daimons?). The names of these airs are a strange conglomeration of both gods and daimons. We find great gods such as Hades, Hephaestus, Isis, Sarapis, Osiris and Hestia, along with lesser and daimonic entities like Eros, the Horai, the Moirai, Asclepius and Hygeia. These lesser deities strikingly include the names given to five of

170 Boll suggests ‘Koros’.

171 *CCAG VIII/3*, 122.5–12: Τῶν δὲ διηρημένων εἰς ἀέρας λς’ θεῶν τὰ ὀνόματά φασι δὲ Αἰδωνεύς, Περσεφώνη, Ἔρως, Χάρις, Ὡραι, Λιταί, Τηθύς, Κυβέλη, Πραξιδική, Νίκη, Ἡρακλῆς, Ἐκάτη, Ἡφαιστός, Ἴσις, Σάραπις, Θέμις, Μοῖραι, Ἔστια, Ἐρινύς, Καίρος, Νέμεσις, Νύμφαι, Λητώ, Καίρος, Λοιμός, Κόρη, Ἀνάγκη, Ἀσκληπιός, Ὑγεία, Τόλμα, Δίκη, Φόβος, Ὅσιρις, Ὠκεανός, Δόλος, Ἐλπίς· ἀφ’ ὧν ἐξήκοντα ἄλλους εἶναι φασι, ἐκ δὲ τούτων τὴν ἄπειρον κίνησιν τοῦ ζωοφόρου κύκλου καὶ τῶν πλανήτων.

172 I follow the diagram of A. Pérez Jiménez, ‘Hephaestio and the Consecration of Statues’, *Culture and Cosmos* 11, no. 1 and 2 (2007): 111–34, here 130. See also the assignment of Cosmas’s decan deities to signs in Gundel, *Dekane*, 72, 81 (Table).

the seven 'Hermetic' lots, assigned to the five non-luminary planets (to be discussed in Chapter Eight): Eros (Venus), Nike (Jupiter), Nemesis (Saturn), Ananke (Mercury), Tolma (Mars). Three of these (Nike, Nemesis and Tolma) are linked to planets in their exaltation signs. It may not be a coincidence, given the confusion surrounding the lots of Eros and Ananke (see Chapter Ten), that Eros/Venus and Ananke/Mercury are, contrarily, in signs of their detriment. In any case, it is another link between daimons and planets.

This passage, late in the annals of Hellenistic astrology, may express a later conflation of Egyptian, Greek and Zoroastrian components, or may just show Cosmas's confusion about astrological practices. In any case, this garbled conflation can show us the seeds both of gods and daimons in decans, as well as the different streams from Egypt, Greece and Persia which flow into Hellenistic astrology.

4.9 *Practical Applications*

Very few extant charts contain calculations of decans. Six charts from Oxyrhynchus list the decans of some planetary positions, in the format '1st decan', '2nd decan', etc. The decans in all cases are listed last, and not identified by either decanic face or Egyptian name.¹⁷³ In *Greek Horoscopes*, only two charts mention decans. The first, No. 81,¹⁷⁴ gives decans, with their Egyptian names,¹⁷⁵ only for the Sun, Moon and Ascendant, perhaps emphasising the importance of these three positions. No. 95¹⁷⁶ has strong Egyptian connections (it includes some Demotic signs¹⁷⁷ and a section in Old Coptic). It is, as Joachim Quack has explained, problematic in its use of the decans.¹⁷⁸ It gives two kinds of decan names (both Egyptian; decanic faces are not mentioned) for the planets and Ascendant: one is called one of the 36 'bright horoscopes', and the other a 'decan'.¹⁷⁹ These appear to come from two different systems of

173 A. Jones, ed., trans. and comm., *Astronomical Papyri from Oxyrhynchus*, 2 vols. (Philadelphia: American Philosophical Society, 1999): Nos 4245 ('deluxe' [in Jones's terminology], gives decan of each planet), vol. 2, 382–83; 4277 (deluxe, decans for planets, angles and lots), vol. 2, 420–25; 4280 (deluxe, too fragmentary to say what decan is given), vol. 2, 428–29; 4283 (deluxe, too fragmentary to say what decan is given), vol. 2, 432–33; 4284 (deluxe, fragmentary, decans given for Lots of Fortune and Daimon), vol. 2, 434–35; and 4285 (deluxe, too fragmentary to say what decan is given), vol. 2, 434–35.

174 Neugebauer and Van Hoesen, *GH*, 21–28.

175 Quack, 'Dekane', §2.1.14 (§2.2.14 2014) (Seti I B series).

176 Neugebauer and Van Hoesen, *GH*, 28–38.

177 *Ibid.*, 29.

178 Quack, 'Dekane', §2.1.14 (§2.2.14 2014).

179 See the chart in *GH*, 37.

Egyptian decans, the ‘decans’ from the Tanis series, and the ‘bright horoscopes’ from either the Seti I C or I B series.¹⁸⁰ Perhaps the two different kinds of decans were associated with different functions in the chart, one with character and one with illness; but no delineation is given to explain their use, so this is speculation.¹⁸¹ But the use of the phrase ‘bright horoscope’ does clearly express decans as hour-markers; more evidence for the connection of the (Ascendant) degree rising on the Eastern horizon with the rising decan, and the Ascendant thus becoming a critical beginning point for the creation of the chart.

In extant ancient astrological apparatus, we find, interestingly, decans somewhat lopsidedly prominent. Four of the seven existing astrological boards depict decans: the Tabula Bianchini, a glass disc from the Kharga Oasis and the Tablettes de Grand (two).¹⁸² In addition, a literary reference to an astrological board also mentions decans.¹⁸³ Thus the decans (and their daimons) persist in an iconography that we can see today as an enduring reminder of their power in antiquity.

180 Quack, ‘Dekane’, §2.1.14 (§2.2.14 2014), thinks Seti I B was used for the bright horoscopes, and Tanis for the decans. Neugebauer and Parker, *EAT* III, 174, think the bright horoscopes are probably Seti I C.

181 A thorough study of this chart would be a useful exercise, but cannot be attempted in this chapter.

182 Evans, ‘Astrologer’s Apparatus’, discusses the Tabula Bianchini, Tablettes de Grand, Daressy Table and Tanis Zodiac. The Tablettes de Grand (two mostly identical ivory *pinakes*) have been well-covered in Abry, ed., *Les tablettes astrologiques de Grand*. The glass disc from the Kharga oasis, which contains decan figures on its outer wheel, is documented in M.-D. Nenna, ‘De Douch (oasis de Kharga) à Grand (Vosges): un disque en verre peint à représentations astrologiques’, *BIFAO* 103 (2003): 355–75. The Daressy Table (now lost) did not depict decans. The Tanis and Nakovana Zodiacs are too fragmentary to know if decans were pictured: see, respectively, *EAT* III, 102–03 and Pl. 47C; and S. Forenbaier and A. Jones, ‘The Nakovana Zodiac: Fragments of an Astrologer’s Board from an Illyrian-Hellenistic Cave Sanctuary’, *JHA* 42 (2011): 425–38, here 427–29, 434 (fig. 8), 436. An astrological disc from Chevroches was probably not an astrological board: see F. Devevey, C. Vernou, and A. Rousseau, ‘The Chevroches zodiacal cap and its Burgundy relations’, in *The Role of Astronomy in Society and Culture, E3, Proceedings of IAU Symposium No. 260, 2009*, ed. D. Valls-Gabaud and A. Boksenberg (© International Astronomical Union: 2011).

183 In *The Alexander Romance* of Pseudo-Callisthenes, the board used by the astrologer Nectanebo is described: ‘he brought out an astrological board...divided into three bands, which had in the first circle the 36 decans, in the second the 12 zodiac signs, and in the middle the Sun and Moon...’ (I, 4.5, Kroll, 4.17, 19–20; 5.1): ‘... προενεργάμενος πίνακα... τριχάρακτον ζώναις, ἐπὶ μὲν τοῦ πρώτου κύκλου δεκανοῦς ἔχοντα τοὺς λς’, ἐπὶ δὲ τοῦ δευτέρου ζώδια τὰ ιβ’, ἐπὶ δὲ τοῦ μέσου ἥλιον καὶ σελήνην...’.

Porphyry, the *Oikodespotēs* and the Personal Daimon

So it would be worthwhile to track down what region your star and your daemon especially designated you to live in and cultivate, for there they favour you more.

MARSILIO FICINO¹

This chapter will investigate astrological connections to the personal daimon, with a focus on the writings of the Neo-Platonic philosopher Porphyry who, in addition to his treatises on philosophical, religious and ethical topics, also wrote an astrological treatise.² Porphyry, like many in his cultural milieu, believed in a personal guiding daimon who aids and encourages its human being toward virtuous behaviour, even as that daimon ratifies, administers and fulfils the choice of life made by the soul prior to incarnation. Building upon ideas drawn from Plato (especially the Myth of Er), Porphyry relates this personal daimon to the astrological technique of finding an *oikodespotēs*, or house-master, of the birthchart. The planet designated as the *oikodespotēs* of the nativity imparts the spirit of the personal daimon (usually called οἰκεῖος δαίμων or ἴδιος δαίμων)³ which goes with the soul when it becomes attached to a body at birth. In his *Letter to Anebo* (14a–d, 15a–b),⁴ Porphyry takes up the idea of finding the *oikodespotēs* of the nativity in order to ascertain a personal daimon. He gives instructions for finding it astrologically in his *Introduction to the Tetrabiblos* (Chapter 30).

This chapter will examine these topics in detail, as well as looking at the ways selected Neo-Platonists dealt with the daimon, and at astrological writings

1 *Liber de vita coelitus comparanda*, 23.27–29 (Kaske and Clark, 370.27–28, 372.29). ‘Proinde operae pretium fuerit indagare, ad quam potissimum regionem habitandam et excolendam te tuum sidus daemonque tuus ab initio designaverit, ibi enim magis aspirant.’

2 *Εἰσαγωγή εἰς τὴν Ἀποτελεσματικὴν τοῦ Πτολεμαίου*, edited by Emilie Boer and Stefan Weinstock in *CCAG* V/4, 185–228. (Hereafter the *Introduction to the Tetrabiblos*.)

3 Both adjectives are used, e.g. Porphyry, *Life of Plotinus*, *Letter to Anebo*; Hephaestio, *Apotelesmatica*; Plutarch, *De genio Socratis* (all οἰκεῖος); Proclus, *Commentary on Plato's Republic*; Zosimus, *Περὶ ὀργάνων καὶ καμίνων γνήσια ὑπομνήματα περὶ τοῦ ω στοιχείου* (ἴδιος). Iamblichus uses both οἰκεῖος and ἴδιος in *De mysteriis*.

4 Porphyry, *Lettera ad Anebo*, ed. A. R. Sodano, (Naples: L'arte tipografica, 1958).

about the *oikodespotēs*. It begins by exploring the views of two representative Neo-Platonists, Plotinus and Iamblichus, on the personal daimon and astrology.⁵ The focus will then turn to Porphyry's views on the *oikodespotēs* and the personal daimon.

1 Neo-Platonism and the Personal Daimon

Daimons are an important consideration in Neo-Platonism. In addition to interest in a personal daimon, the Neo-Platonists also acknowledge and try to deal with both good and bad daimons. Iamblichus insists that only a good daimon can be one's personal daimon,⁶ but Neo-Platonists also recognize that bad daimons exist in the world and cause misery.⁷ Astrology is also discussed by several Neo-Platonists (including Plotinus, Porphyry and Iamblichus), including its role in fate, free will and choice.⁸ In Porphyry especially, these discussions also involve the personal daimon.

Modern scholars generally mark the beginning of Neo-Platonism with Plotinus.⁹ However, the ideas of Platonism develop along a continuum, so this designation is more chronological than philosophical (and, of course, unknown in antiquity). Conceptions of the daimon in Neo-Platonism come out of those in Middle Platonism, perhaps best exemplified by Plutarch, as we saw in Chapter One, and in Apuleius and other Middle Platonists like Numenius.

5 Timotin, *Démonologie*, 309–14, discusses the personal daimon and astrology in a Neo-Platonic context, from a more philosophical and less astrological viewpoint than I shall use. His discussion thus complements mine.

6 *DM IX.7* (Clarke/Dillon/Hershbell, 282.2–4). The idea that a personal daimon is only good appears in Menander, fr. 714 (cited in Luck, *Arcana Mundi*, 172).

7 See Porphyry, *De abstinence* 2, 38.4, 39.3, 40.1–4, etc.

8 Other Neo-Platonists who discuss astrology include Proclus, Olympiodorus, Simplicius and Hierocles: see M. Lawrence, 'Hellenistic Astrology', *Internet Encyclopedia of Philosophy* (2005), <http://www.iep.utm.edu/astr-hel/>, accessed 23 March 2015; eadem, 'The Meaning of Astrology for Late Neoplatonists: Simplicius and Olympiodorus' (paper presented at the 12th Annual Conference of the International Society for Neoplatonic Studies, Lisbon, Portugal, 16–21 June 2014).

9 J. Dillon and L. P. Gerson, *Neoplatonic Philosophy: Introductory Readings* (Indianapolis/Cambridge: Hackett Publishing Co., 2004), xiii (Introduction); A. Smith, 'Porphyry—Scope for a Reassessment', in *Studies on Porphyry*, ed. George Karamanolis and Anne Sheppard (London: *BICS* Supplement 98, 2007), 9 and n. 6.

Neo-Platonism develops a hierarchy of daimons, angelic beings and gods.¹⁰ This is particularly evident in Plotinus and Iamblichus, but Porphyry also inquires about the hierarchy and definitions of various classes of divine beings.¹¹

Astrology is sometimes incorporated into the Neo-Platonic system and accepted especially by Porphyry and Proclus, while reservations are expressed by Plotinus and Iamblichus. For Plotinus, the emphasis on solely physical causation is problematic (*Ennead* II, 3),¹² while for Iamblichus the faulty interpretations of astrologers give him pause (*DM* IX.4).¹³ In addition, discussions of free will often use astrology as a whipping boy for fatalism (confused with determinism, even today), including popular notions that astrology mandates an unalterable fate and that the stars are not only causes, but allies and enablers, of *heimarmenē* and *anankē*.¹⁴ With regard to the daimon and astrology, Porphyry seems most interested in reconciling concepts of daimon with astrological practice, including techniques for finding a representative personal daimon in the birthchart (see section 3 of this chapter). But let us begin with Plotinus and his thoughts about daimons and astrology. Porphyry was the student of Plotinus, and Iamblichus may have been taught by Porphyry (but differed from him in many respects, not the least being the importance of theurgy). This lineage has a bearing on the integration of the daimon into the astrological practice of Neo-Platonists.

1.1 *Plotinus*

In his *Life of Plotinus*, Porphyry recounts how the personal daimon of Plotinus was discovered to be not a mere daimon, but a god. An Egyptian who had come to Rome offered to invoke Plotinus's 'personal daimon' (οἰκεῖος δαίμων), but a

10 For a substantial discussion of the daimon in Neo-Platonism, see Timotin, *Démonologie*, 141–61.

11 See the discussion of J. Dillon, 'Iamblichus of Chalcis (c. 240–325 AD)', in *ANRW*, vol. II.36.2, ed. Wolfgang Haase (Berlin/New York: Walter de Gruyter, 1987), 862–909, here 900–02.

12 Though not all astrologers would subscribe to this view. Ptolemy is the main proponent of physical causation.

13 Blaming the technique and interpretive skills of astrologers has a long history, even (or perhaps especially) among astrologers themselves. See the discussion of Clarke, *Iamblichus' De mysteriis: A manifesto of the miraculous*, 30, concerning the contamination of prediction by human fallibility.

14 Seen in Hermetic texts, but also used by opponents of astrology such as Sextus Empiricus, though less in the works of actual astrologers, who tend to be more nuanced in their assessments of fate and necessity (see, e.g. Ptolemy and Vettius Valens, though both have very different views of astrology and its connection to fate).

god appeared instead (*Vita Plotini* 10.14–33).¹⁵ This event was supposedly the impetus for Plotinus's discussion of the personal daimon in *Ennead* III, 4.¹⁶

Plotinus views astrology as something that can be semiotic but not necessarily causal.¹⁷ If some astral connection and responsibility in human lives is admitted, as in the Myth of Er, this provides a reason for astrology, and astrology must be (partly) bound up in fate and providence. Plotinus follows the basic idea of the Myth of Er (II, 3.9.1–14; 3.15.1–5).¹⁸ Souls come to birth choosing their lives, but affected by the planetary circumstances in which they are born. Plotinus says that the universe is a mixture of God and daimon, and the passions (τὰ πάθη) are the daimonic part: 'And so [the All] is a God when that [highest divine soul] is counted in with it, but the rest, he [*i.e. Plato*] says, is a great Daimon,¹⁹ and the passions in it are daimonic.'²⁰

15 Plotinus, *Opera*, eds Paul Henry and Hans-Rudolf Schwyzer, 3 vols (Leiden: Brill, 1951–1973), here vol. 1 (*Vita Plotini*), 16–17. See also Porphyry, *Porphyry: La vie de Plotin*, ed., trans. and comm. Luc Brisson, 2 vols., vol. II (Paris: Librairie Philosophique J. Vrin, 1992), 152–53; and *Neoplatonic Saints: The Lives of Plotinus and Proclus by their Students*, trans. Mark Edwards (Liverpool: Liverpool University Press, 2000), 19–20.

16 Plotinus, *Plotinus Ennead III*, trans. A. H. Armstrong (Cambridge, MA/London: Harvard University Press, 1967, repr. 2006), Introductory Note, 140. See also the discussion of this event and of *Ennead* III, 4 in Timotin, *Démonologie*, 286–300.

17 E.g. *Ennead* II, 3; III, 1. This is a simplified description of a complex essay. For more on how Plotinus viewed astrology, see four analyses that approach it from different perspectives: J. Dillon, 'Plotinus on Whether the Stars are Causes', *Res Orientales* 12 (*La Science des Cieux. Sages, mages, astrologues*) (1999): 87–92; M. Lawrence, 'Who Thought the Stars are Causes? The Astrological Doctrine Criticized by Plotinus', in *Metaphysical Patterns in Platonism*, ed. John F. Finamore and Robert M. Berchman (New Orleans: University Press of the South, 2007); P. Adamson, 'Plotinus on Astrology', *OSAPh* 35 (2008): 265–91; and C. Addey, *Divination and Theurgy in Neoplatonism: Oracles of the Gods* (Farnham, Surrey/Burlington, VT: Ashgate, 2014), 205–08. Plotinus focuses on *σημαίνειν* versus *ποιεῖν* and the philosophical differences between them. But Lawrence is right to point out (29) that astrological treatises often interchangeably (and apparently without considering philosophical implications) use 'σημαίνει' and 'ποιεῖ' when they talk about effects arising from astrological configurations. The practice is widespread (cf. Valens, Paulus, Olympiodorus, Hephaestio). Even today, modern astrologers speak *as if* the planets 'do' things to people, though many do not actually think there is a mechanism or physical influence by which astrological configurations correlate with human events.

18 For more on the Myth of Er, daimon and astrology, see Chapter 8, 1.1 ('The Daimon and the Lot'), 282–85.

19 Meaning Eros, the 'great daimon' of *Symposium* 202d.

20 II, 3.9.46–47 (Henry/Schwyzler): Θεός μὲν οὖν ἐκείνης συναριθμουμένης, τὸ δὲ λοιπὸν δαίμων, φησί, μέγας καὶ τὰ πάθη τὰ ἐν αὐτῷ δαιμόνια. Armstrong translates τὰ πάθη as 'what happens': 'The universe is a god if the separable soul is reckoned as part of it; the rest, Plato

Plotinus draws on portions of Plato's *Republic* (x, 616c–d), mentioning the spindle, planets and stars and the Moirai; and the *Timaeus*, saying that the planets' relationships to the passions 'bind us to the stars, from which we get our souls';²¹ whence come our characters and the actions resulting from them. When he says, about the soul approaching its coming into birth, that 'something comes to it' (ἤκειν τι) (II, 3.10.4),²² something that is subject to passions²³ (τι παθητικὸν ἔχουσα) (3.10.5–6), what could he mean? Peter Adamson suggests that 'the soul acquires its passive part as it descends',²⁴ and Plotinus has already said that the heavenly gods provide the soul with 'the terrible and necessary passions'.²⁵ In the essay *On What is Up to Us*, Porphyry speaks of the seven spheres the souls pass through, each inciting it with different desires.²⁶

says, is a "great daemon" and *what happens* in it is daemonic.' McKenna translates 'and its ways are subdivine'. Neither, in my opinion, conveys the message that passions are linked to daimons, which is what I think Plotinus is saying.

- 21 II, 3.9.10–11 (Henry/Schwyzler): Οὐτοὶ γὰρ οἱ λόγοι συνδέουσιν ἡμᾶς τοῖς ἄστροις παρ' αὐτῶν ψυχὴν κομιζομένους. . . . (trans. Armstrong). The *Timaeus* passage, 69c–d, refers to the passions which make a part of the 'mortal soul'. These passions, says Plotinus, come from the gods-as-planets (II, 3.9.6–10, Henry/Schwyzler). (The astrological Sun and Moon are both associated with the soul.)
- 22 Trans. Adamson, 'Plotinus on Astrology', 288.
- 23 I use the translation 'passions', but no one English word adequately expresses the Greek sense of *pathē*; neither passions, affections, emotions, passivity, suffering nor even experience.
- 24 Adamson, 'Plotinus on Astrology', 287–88, n. 44 (in the note he mentions the entire passage from which this comes, and the difficulty in interpreting it).
- 25 II, 3.9.7–8: τὰ δεινὰ καὶ ἀναγκαῖα πάθη (Henry-Schwyzler).
- 26 Porphyry, 'Περὶ τοῦ ἐφ' ἡμῖν' (Smith, 305.68–71 [P.37, 271F] ≈ Wachsmuth, II, 171.1–5): . . . τοῦ <δὲ> πρώτου βίου ἢ διέξοδος διὰ τῶν ἑπτὰ σφαιρῶν γιγνομένη, ἄλλως ἄλλης κατ' αὐτὰς κινουμένης κατὰ τὰς προθυμίας πρὸς τινὰς τῶν δευτέρων βίων. . . . 'When the [soul's] passage through the seven spheres of the first type of life happens, another passage down them incites [the soul] differently, according to the desires it has for certain of the second lives. . . . J. Wilberding, in *Porphyry: To Gaurus on How Embryos are Ensouled and On What is in Our Power*, 146, translates 'The pathway of the first life takes place across the seven spheres, but each [soul] moves through these [spheres] in a different way according to their impulses towards certain second lives. . . . In his commentary (130), he ingeniously suggests (130–31), based on the soul's location, that ' . . . after making its choice, a soul ascends to the hōrokopos in the sphere of the fixed stars before descending back down through the planetary spheres to the sublunary region. . . . This accounts for two passages through the spheres, one up and one down. Proclus Diadochus, *Proclus, Commentaire sur la République*, trans. and annot. A. J. Festugière, 3 vols. (Paris: Librairie Philosophique J. Vrin, 1970), here vol. 3, 356, renders this passage: 'D'autre part, comme, en sa première descente, l'âme passe à travers les sept sphères, et que, juste à ce moment-là,

Macrobius describes well the different attributes, akin to passions, that the soul acquires from each of the planets as it descends.²⁷

Since Plotinus has just mentioned the 'great daimon' and that the passions in the universe are daimonic, could the something that comes to the soul also be its allotted daimon who, being subject to passions itself (but on a higher level than the soul), can help the incarnated soul strive to control them? The connection between daimons and passions is well known;²⁸ being subject to passions is a condition of being human. The daimon, nevertheless, is both the bearer of passions and the guide toward the attainment of virtue. When the soul incarnates, it brings its daimonic guide with it (as the Myth of Er says). Iamblichus, furthermore, says as much when he tells us:

chaque sphère imprime en l'âme des désirs différents qui influenceront sur son choix de telle ou telle deuxième vie. . . ! He thus suggests that both passages are downward. Note that A. Smith, 'Porphyrian Studies Since 1913', in *ANRW*, vol. II.36.2, ed. Wolfgang Haase (Berlin/New York: Walter de Gruyter, 1987), 717–73, here 727 n. 49, has miscited the source of Festugière's translation. He has also, I think, misunderstood Festugière's position on the stages of 'first' and 'second' lives the soul passes through on its way to incarnation. I do not believe, as Smith suggests, that Festugière understood the first and second lives (*bioi*) as distinct from one another, but as stages of choice for the soul in becoming incarnated into one eventual life which has two components. See Festugière, 349, nn. 1 and 2, and Festugière's translation, 354, of 169.15–20, 'types d'existence de premier ordre et des types de second ordre.' (Perhaps we could apply the 'first' and 'second' lives to the moment of conception and the moment of birth.)

27 Macrobius, *Commentary on the Dream of Scipio*, I, 12.14 (Willis, II, 50): 'in Saturni ratiocinationem et intellegentiam, quod λογιστικόν et θεωρητικόν vocant: in Iovis vim agendi, quod πρακτικόν dicitur: in Martis animositatis ardorem, quod θυμικόν nuncupatur: in solis sentiendi opinandique naturam, quod αισθητικόν et φανταστικόν appellant; desiderii vero motum, quod επιθυμητικόν vocatur, in Veneris: pronuntiandi et interpretandi quae sentiat quod έρμηνευτικόν dicitur in orbe Mercurii: φυτικόν vero, id est naturam plantandi et augendi corpora, in ingressu globi lunaris exercet.' 'In the sphere of Saturn it obtains reason and understanding, called *logistikón* and *theoretikón*; in Jupiter's sphere, the power to act, called *praktikón*; in Mars' sphere, a bold spirit or *thymikón*; in the sun's sphere, sense-perception and imagination, *aisthetikón* and *phantastikón*; in Venus' sphere, the impulse of passion, *epithymetikón*, in Mercury's sphere, the ability to speak and interpret, *hermeneutikón*; and in the lunar sphere, the function of molding and increasing bodies, *phytikón*.' (Trans. Stahl, in *Macrobius. Commentary on the Dream of Scipio*, trans. and annot. William Harris Stahl (New York: Columbia University Press, 1952).)

28 See, e.g. Plutarch, *De Iside et Osiride*, 25.360d–e. (See also Chapter 4, 1.3, 'Greek Demons', 123–24.) For more discussion of the daimon and passions, see Timotin, *Démonologie*, e.g. 96–99, 122–25, 137, 165–67, 213–19, etc.

If I am to reveal to you the truth about the personal daimon, it is not from one part only of the heavenly regions nor from any one element of the visible realm that this entity is imparted to us, but from the whole cosmos and from the whole variety of life within it and from every sort of body, through all of which the soul descends into generation, there is apportioned to us an individual lot, assigned to each of the parts within us according to an individual authorising principle. This daimon, then, stands as a model for us even before the souls descend into generation.²⁹

We see the lineage of the idea of a personal daimon accompanying the soul into generation deriving from Plato and moving from Plotinus through Porphyry to Iamblichus. Natal astrology becomes a part of this system, since it is already predicated on the moment of birth (and tries to find the moment of conception: the moment of incarnation). Astrology is logically associated with a system like Plato's that ties fate and the daimon into incarnation.³⁰

Plotinus's early treatise on the personal daimon (*Ennead* III, 4, number 15 in the chronological order of the *Ennead* treatises) was, as Armstrong's introduction says, 'written... before Porphyry came to Rome'.³¹ Plotinus's goal is to reconcile the various treatments of the daimon in Plato (*Republic*, *Timaeus*, *Phaedrus*, *Phaedo*, *Theaetetus*). He sees the personal daimon as a guiding spirit who is hierarchically above the level at which a human life is being lived (III, 4.3.6–20, esp. 18–20), serving both as guide and as aspiration.³² Furthermore, he connects this guiding daimon with the stars and planets, following the idea of the *Timaeus* that each soul has its own star.³³

29 *DM* IX.6, 280.1–8 (Des Places, trans. Clarke/Dillon/Hershbell): Εἰ δὲ δεῖ σοι τὸν ἀληθῆ περι τοῦ οἰκείου δαίμονος λόγον ἀποκαλύψαι, οὐκ ἀφ' ἑνὸς μέρους τῶν ἐν τῷ οὐρανῷ οὐδ' ἀπό τινος στοιχείου τῶν ὀρωμένων ἀπονέμεται ἡμῖν οὗτος, ἀφ' ὅλου δὲ τοῦ κόσμου καὶ τῆς παντοδαπῆς ἐν αὐτῷ ζωῆς καὶ τοῦ παντοδαποῦ σώματος, δι' ὧν ἡ ψυχὴ κάτεισιν ἐπὶ τὴν γένεσιν, ἀπομερίζεται τις ἡμῖν μοῖρα ἰδίᾳ πρὸς ἕκαστον τῶν ἐν ἡμῖν ἀπομερίζομένη κατ' ἰδίαν ἐπιστάσιαν. Οὗτος δὲ οὖν ὁ δαίμων ἔστηκεν ἐν παραδείγματι πρὸ τοῦ καὶ τὰς ψυχὰς κατιέναι εἰς γένεσιν.

30 And it is logical for Porphyry, as a student of Plotinus and following the Platonist line, to seek the personal daimon in the astrological chart. The two, daimon and soul, are intertwined before birth, so why not at the moment of birth, which the birthchart shows in its arrangement of planets and zodiacal signs?

31 Armstrong, *Plotinus Ennead III*, 140. Armstrong also cites Dodds, *Greeks and the Irrational*, 289–91.

32 See Armstrong, *Plotinus Ennead III*, 140–41. For additional views, see Timotin, *Démonologie*, 299–300 and n. 212.

33 *Timaeus* 41d–e. What about bad daimons? Plotinus says they can be in charge of souls which come into 'bestial bodies' (θῆρεια σώματα) (III, 4.6.17–19, Henry/Schwyzler).

The soul is drawn to ‘the star which is in harmony with the character and power which lived and worked in them; and each will have a god of this kind as its daimon . . .’.³⁴ This may be where Porphyry got the idea of a ruling planet in the chart as representative of the personal daimon.

Plotinus says the guardian daimon can be the same or change from life to life, depending on the life the soul chooses (III, 4.6.10–12, 4.6.46–47).³⁵ Here Plotinus uses the metaphor of a soul aboard a ship, as the soul moves through the life with its daimon. Nature, called ‘a spindle’ (*Republic* x.616c), puts the soul with its daimon ‘in some seat of fortune’, likened to a particular ship the soul inhabits during the human’s life.³⁶ The events of the life are moved by the circuit of heaven and its winds, and the human responds both to the tossing of the ship and his own impulses or desires. Plotinus makes allowances for individual and particular reactions to life events by saying

... he is on the ship precisely in his own way. For everyone is not moved and does not will or act alike in the same circumstances. So different things happen to different people as a result of the same or different occurrences, or the same things to others even if the circumstances they encounter are different; for that is what *heimarmenē* is like.³⁷

(By asking if these are less than daimons, Plotinus implies that bad daimons fall into a different category than good ones.) I think Plotinus uses the adjective ‘θήρεια’ to apply only to animals, and not to a human of ‘bestial’ character, thus giving bad daimons only to the souls of animals and leaving good daimons to humans. This seems to interpret *Timaeus* 42c, where those who have lived wicked lives reincarnate as animals. Plotinus also mentions a wicked man entering into a ‘bestial life’, βίον θήρειον (i.e. the life of an animal), in III, 4.3.16–17 (Henry/Schwyzler).

34 III, 4.6.27–29 (Henry/Schwyzler, trans. Armstrong): πρὸς ἄστρον τὸ σύμφωνον τῷ ἐνεργήσαντι καὶ ζήσαντι ἦθει καὶ δυνάμει· καὶ τοιοῦτῳ θεῷ καὶ δαίμονι . . . χρήσεται . . .

35 In fact he is somewhat inconsistent, for he claims in III, 4.3.10–14 (Henry/Schwyzler) that the ‘principle’ (that which activates the life) chosen by the soul/life, which has its own daimon, does not remain after death but must yield to the principle of the next life and another daimon. But perhaps the soul can choose the same ‘principle’ again and have the same daimon, as in this later example.

36 III, 4.6.47–50 (Henry/Schwyzler): Ἐπιβαίνει οὖν μετὰ τούτου τοῦ δαίμονος ὡς περ σκάφους τοῦδε τοῦ παντὸς πρώτον, εἶτα παραλαβοῦσα ἢ τοῦ ἀτράκτου λεγομένη φύσις κατέταξεν ὡς περ ἐν νηὶ εἰς τινα ἔδραν τύχης. This ship metaphor is prominent in Plato. See below, section 3, 269–70.

37 III, 4.6.55–60 (Henry/Schwyzler, trans. Armstrong): . . . ἐπὶ νεῶς εἶναι παρὰ τὸν ἑαυτοῦ τρόπον. Οὐ γὰρ ὁμοίως ἐν τοῖς αὐτοῖς πᾶς κινεῖται ἢ βούλεται ἢ ἐνεργεῖ. Γίνεται οὖν διάφορα διαφοροῖς ἢ ἐκ τῶν αὐτῶν ἢ διαφορῶν προσπεσόντων, ἢ τὰ αὐτὰ ἄλλοις, κἂν διάφορα τὰ προσπεσόντα τοιοῦτον γὰρ ἢ εἰμαρμένη.

Human *heimarmenē*, then, is composed of both nature and the body (the moving ship) and human desires, creating a unique and not totally pre-ordained destiny (just as different actors can play the same part in a play in many different ways; they must stay within the structure of the play and the lines they are given, but the interpretation is their own). The soul, having been placed in a particular configuration and ‘circuit of heaven’ (περιφορά, the paths of the planets revolving around the spindle in the Myth of Er), is buffeted by the winds of that heavenly circuit. It is not much of a stretch to envision this beginning with the configuration of planets in the heavens at the time of birth. The rôle we are given is analogous to the astrological configuration at birth, but how we play it depends on us. Moreover, Plotinus says twice in this treatise³⁸ that we are each ‘an intelligible cosmos’ connecting upper and lower worlds by means of the soul;³⁹ since the planets are seen as representatives of divine intelligence, again it is not a stretch to consider that the astrological chart shows the placement of these divine intelligences in our personal universe. Plotinus has specifically mentioned the spindle, the fates and the ‘circuit of heaven’ (II, 3.9). He accepts the idea of souls wedded to the gods of the heavens: God gives humans soul, but the ‘gods borne through the heavens’ (i.e. the planets) give them passions. But we also have our chosen daimon, and the ability to control our passions, our reactions to events.

The reaction to the events created by the movement of the metaphorical ship of III, 4.6 is partly based on human choice, which is why the same circumstances affect different people differently, or why different circumstances may produce the same reactions in people. There are parallels to this kind of thinking in Vettius Valens (VII, 6.127–160). Coincidentally employing the theme of ships and their passengers,⁴⁰ this section concerns six survivors of a near-shipwreck, one of whom was probably Valens himself. The six, naturally with different birthcharts, were all experiencing astrological crisis periods. The planets involved were different in each case, but in every case were those connected with ships and accidents—namely either Saturn (‘disposed toward

38 III, 4.3.22–24 (Henry/Schwyzler):...καὶ ἑσμεν ἕκαστος κόσμος νοητός, τοῖς μὲν κάτω συνάπτοντες τῷδε, τοῖς δὲ ἄνω καὶ τοῖς κόσμου τῷ νοητῷ....‘...and we are each an intelligible cosmos, conjoining the lower cosmos with the parts of the soul below and to the intelligible cosmos with the parts above...’. III, 4.6.21–23 (Henry/Schwyzler):...χρὴ γὰρ οἶσθαι καὶ κόσμον εἶναι ἐν τῇ ψυχῇ ἡμῶν μὴ μόνον νοητόν ἀλλὰ καὶ ψυχῆς τῆς κόσμου ὁμοειδῆ διάθεσιν....‘...for one must know also that there is a cosmos in our soul, not only intelligible, but also an arrangement like the form of the World Soul...’.

39 This is similar to the macrocosm/microcosm idea.

40 But allusions to ships would not be uncommon in this Mediterranean culture.

sailing, those plying waterside trades⁴¹ and bringing about ‘violent deaths in water . . .’),⁴² the Moon (being alive, the body, ships)⁴³ and/or Mars (violence, losses, piracy).⁴⁴ But the six survivors had benefics involved which mitigated the disastrous effects: thus all survived the shipwreck by the ability of the pilot to use the wind in the sails skilfully, even though the ship had taken on water and the steering oar had been lost.

Valens, as Plotinus, is aware of the natural operation of *heimarmenē* and uses this example to show it: ‘In order to show the wonder of nature, and that nothing happens apart from fate, but that those caught with one accord in battle and accidental collapse, or fire and shipwreck, or some other cause are brought together by fate, we shall show by a brief example.’⁴⁵ The six are brought by *heimarmenē* (reflected in their astrological configurations at the time) to be together on a ship that runs into trouble, where the pilot, through his skill, saves their lives and the ship. For Valens, possibly, the skilful pilot represents the benefics each survivor had working in his chart at the time.⁴⁶ For Plotinus, perhaps the pilot’s good decisions and skill would show the human will and ability to make right choices, aided by the encouragement of the personal daimon. For Valens, the same circumstances supply different astrological reasons for different people, while for Plotinus, different things happen to different people in the same circumstances as a result of both nature and human choice. Certainly Valens, a working astrologer, is mainly interested here in showing how *astrology* illumines the workings of fate, and not necessarily

41 *Anthology*, I, 1.7 (Pingree, 2.4): . . . πλευστικούς, πάρυγρα πράσσοντας.

42 *Ibid.*, I, 1.15 (Pingree, 2.17): τούς δὲ θανάτους ἀποτελεῖ βιαίους ἐν ὕδατι. . .

43 *Ibid.*, I, 1.4 (Pingree, 1.15–16, 19): . . . σημαίνει μὲν κατὰ γένεσιν ἀνθρώποις ζώην, σῶμα . . . πλοῖα. . .

44 *Ibid.*, I, 1.21 (Pingree, 2.31–3.2): <’Ο> δὲ τοῦ Ἄρεως σημαίνει βίας . . . ἐκπτώσεις . . . ληστείας. . . Ἐκπτώσεις can also mean shipwrecks.

45 *Ibid.*, VII, 6.127 (Pingree, 274.11–14): Πρὸς δὲ τὸ θαυμάσαι τὴν φύσιν καὶ ὅτι χωρὶς εἰμαρμένης οὐδὲν γίνεται, ἀλλὰ καὶ οἱ ἐν πολέμῳ καὶ συμπτώσει ἢ ἐμπρησμῷ καὶ ναυαγίῳ ἢ καὶ κατὰ ἄλλην αἰτίαν τινὰ ἀλίσκόμενοι ὁμοθυμαδὸν συνάγονται ὑπὸ τῆς εἰμαρμένης, ἐκ μικροῦ ὑποδείγματος δηλώσωμεν. (The chart that is probably Valens’ is one of the examples.)

46 In this case the outcome was happy, and the decisions made by the pilot were good. In modern times, on the other hand, see the unfortunate example of the Titanic. A more recent shipwreck, dogged seemingly by *heimarmenē*, occurred off the coast of Gloucester, Massachusetts in October 1991, where every decision made by captain and crew led more inexorably to their destruction: see S. Junger, *The Perfect Storm: A True Story of Men Against the Sea* (New York: W. W. Norton & Co., 1997).

on the human capacity for choice,⁴⁷ but we should not forget that since Valens himself was probably a passenger on the ship, the workings of fate and degrees of choice, or the intervention of providence, may have had some immediacy for him.

The human capability of choosing how to react, either yielding to passion or controlling it (to continue the analogy, falling to the deck or having the presence of mind to grab on to the railing of the ship), has something to do with the guardian daimon and its encouragement toward a higher and more virtuous life. (The daimons, as usual, lie in the middle: they are paradoxically subject to passions, but they are also, according to Plotinus, on a higher and more virtuous plane so that they can guide us.)

These kinds of ideas may have led Porphyry to develop his idea of the guiding daimon represented by a ruling planet called the *oikodespotēs*, or one called the lord of the geniture (as laid out in the *Letter to Anebo*, 2.14c, 15c). The methods for finding such a ruling star—from which length of life can be determined, but character as well—are given in his *Introduction to the Tetrabiblos* (see below).

The daimon's importance to Neo-Platonists is summed up by Proclus (who was influenced by Porphyry and Plotinus) in this paean:

The daimon alone moves all, governs all, orders all our affairs. For it perfects the reason, moderates passions, inspires nature, maintains the body, provides the accidentals, fulfils the decrees of fate and bestows gifts from providence; and this one being is king of all that is in us and all that has to do with us, steering our whole life.⁴⁸

Statements like this demonstrate why finding one's personal daimon was so important (and not only to Neo-Platonists: as we have seen in Chapter Six, the Magical Papyri contain examples of how to find the personal daimon). We turn

47 Komorowska, *Valens*, 352–60, esp. 355–58 also discusses the shipwreck passage, acknowledging Valens' primary interest not in philosophy or ontology, but in astrological practice.

48 Proclus, *On Alcibiades* I, 78.1–6 (Westerink): *μόνος δὲ ὁ δαίμων πάντα κινεῖ, πάντα κυβερνᾷ, πάντα διακοσμεῖ τὰ ἡμέτερα. καὶ γὰρ τὸν λόγον τελειοῖ καὶ τὰ πάθη μετρεῖ καὶ τὴν φύσιν ἐμπνεῖ καὶ τὸ σῶμα συνέχει καὶ τὰ τυχαῖα χορηγεῖ καὶ τὰ εἰμαρμένα πληροῖ καὶ τὰ ἐκ τῆς προνοίας δωρεῖται· καὶ εἰς ἐστὶν οὗτος ἀπάντων τῶν ἐν ἡμῖν καὶ περὶ ἡμᾶς βασιλεὺς, οἰακίζων ἡμῶν τὴν σύμπασαν ζωήν.* (Trans. [modified] of W. O'Neill, in Proclus Diadochus, *Proclus: Alcibiades I, A Translation and Commentary*, trans. and comm. William O'Neill (The Hague: Martinus Nijhoff, 1965)) This statement has similarities with Iamblichus's at *DM* IX.6, 280 (as quoted in J. Dillon, 'Iamblichus on the Personal Daemon', *AncW* 32.1 (2001): 3–9, here 4). See also Timotin, *Démonologie*, 311–12.

now to Iamblichus on daimons and astrology. His development of theurgy as a way to be one with the divine is a counterpoint to Porphyry, both in his understanding of the daimonic and the divine, and in his use of astrology as a practicing Neo-Platonist.

1.2 *Iamblichus*

I approach Iamblichus's work through the dialogue with Porphyry which shapes large sections of *De mysteriis*. The treatise is set up as answers to questions posed by Porphyry in his *Letter to Anebo*,⁴⁹ who wants to know, among other things, about the place of daimons in the cosmos, and about astrology.

Porphyry asks 'Anebo' about predicting the future (2.1a = *DM* III.1, 99). Divination can be attained through dreams, divine inspiration, possession, visions and magical incantations (2.2a–f). There is also a 'technical' side to divination (τέχνη ἀνθρωπίνη) (2.2g), and this is where astrology comes in, as a 'technique for pursuing the future through . . . stars' (2.2g).⁵⁰ Porphyry wants to know who provides information about the future: is it gods, angels, daimons or something else (2.3b)? Iamblichus does not deny that divine beings come in various guises and exist at different levels, but they are not to be used to see the future willy-nilly, but to help the human soul advance on the path of becoming more divine. The preferred method for this is through theurgy. In fact, he claims that gods can deliberately *not* tell the future when it is in the interest of the human soul's virtue: 'Whenever it is necessary for the soul to exercise virtue, and uncertainty of the future contributes to this, the Gods conceal the things that will happen in order to make the soul better' (*DM* x.4, 289.13–15).⁵¹ The goal is not to see the future, but to become more god-like. (One wonders if the influence of the personal daimon also comes into play, urging the incarnated soul towards the path of virtue, as Plotinus might say.)

This does not mean that technical means of divination as a component of theurgy are ignored. Iamblichus allows that astrology could be a tool of theurgy. Taking his cue from the Egyptian astrologers, he is aware of the opportune moment (*kairos*) at which theurgic rituals, leading the soul to realms beyond fate and toward the highest god, should be begun:

49 What remains of the *Letter to Anebo* are portions quoted in *DM* and Eusebius, *PE* (plus a couple of others). The fragments were collected and arranged by A. R. Sodano. I follow his numbering here.

50 2.2g (Sodano, 11.4): . . . δι' ἀστέρων τέχνην . . . τῆς θήρας τοῦ μέλλοντος.

51 Shaw, *Theurgy and the Soul*, 234, discusses this matter (this is Shaw's translation, slightly modified).

but they recommend that we ascend through the practice of sacred theurgy to the regions that are higher, more universal and superior to fate, towards the god who is the creator, without calling in the aid of matter or bringing to bear anything other than *the observation of the opportune moment*.⁵² (my italics)

This clearly means katarchic astrology, which includes choosing the right astrological moment (*kairos*) to begin something.⁵³ Iamblichus privileges this form of divination as an aid to the theurgic practice of becoming more divine.

Regarding other astrological practices, especially as they relate to the personal daimon, Iamblichus is more wary. Porphyry wants to know what Anebo thinks of the notion that the planet which is the astrological 'house-master of the nativity', the *οικοδεσπότης τῆς γενέσεως*,⁵⁴ imparts the personal daimon (the daimon is the spirit of that planetary god).⁵⁵ Iamblichus replies by explaining that there are two ways to approach the discovery of the personal daimon: one is theurgic and one technical (astrological):

To put the matter simply, one may take two approaches to the personal daimon, the one theurgic, the other technical; following the former procedure, one summons the daimon down from the higher causal principles, while according to the latter, from the visible cycles in the nativity; the former makes no use of natal astrology, while the latter makes use also of such procedures; the former operates on a more universal basis, transcending the realm of nature, while the latter conducts its worship on a particular level, following the dictates of nature. All this being the case, you seem to me to be proceeding inappropriately in dragging down

52 *DM VIII.4*, 267.6–10 (Des Places): ... ἀλλὰ καὶ διὰ τῆς ἱερατικῆς θεουργίας ἀναβαίνειν ἐπὶ τὰ ὑψηλότερα καὶ καθολικώτερα καὶ τῆς εἰμαρμένης ὑπερκείμενα παραγγέλλουσι πρὸς τὸν θεὸν καὶ δημιουργόν, μήτε ἄλλην προσποιουμένους μήτε ἄλλο τι προσπαραλαμβάνοντας ἢ μόνον καιροῦ παρατήρησιν. (trans. Clarke/Dillon/Hershbell, slightly modified). Shaw, *Theurgy and the Soul*, 201, points out that astrology was used to find the proper time for a theurgic ritual. See the discussion of this passage in Addey, *Divination and Theurgy*, 105–06.

53 For katarchic astrology in ritual, see Hephaestio, III, 6.11 (this passage will be discussed in Chapter 10). Katarchic charts are used in spells of the Magical Papyri, e.g. PGM IV.2967–3006, PGM VII.505–528, PGM XIII.1027–1039, PDM XIV.1–114 (see Chapter 6, 1.1–1.4, 1.6).

54 *Letter to Anebo*, 2.15c = *DM IX.5*, 278.12–13.

55 For similarities to this in the Arabic tradition, see C. Burnett, 'Ṭābit Ibn Qurra the Ḥarrānian on the Talismans and the Spirits of the Planets', *La Corónica* 36.1 (2007): 13–40.

the more perfect type of worship to the merely human level, and exercising your prowess in raising difficulties on that.⁵⁶

Naturally Iamblichus is more interested in (and finds more effective) the theurgic practice. (Porphyry's slant, stemming from his interest in astrology, is different.) Iamblichus does not dismiss astrology entirely, although he obviously considers it inferior to pure theurgy. But for him, theurgy transcends nature (while also operating through nature), while astrology must operate within nature. When Porphyry emphasises the *oikodespotēs* as the personal daimon, Iamblichus is quick to point out that it is not quite that simple:

... you seem to me to be cutting off just a small portion of the whole question concerning the daimon. For whereas those experts who operate within the bounds of nature are accustomed to give it its designation in due order on the basis of the decans and the 'servitors', the zodiacal signs and the stars, the sun and the moon, from the Greater and Lesser Bear, and from all the elements and the cosmos as a whole, you are making the error of detaching one small part of this, that of the 'master of the house', and have concentrated all your enquiries on that. (*Letter to Anebo*, 14b = *DM IX.2*, 273.10–274.3)⁵⁷

Iamblichus's point is that one cannot find the personal daimon by using just one astrological technique, or even the astrological chart as a whole, but must take every part of the entire cosmos into account, presumably by methods

56 *DM IX.1*, 273.2–9 (Des Places): ὡς μὲν οὖν ἀπλῶς εἰπεῖν, διττῆς οὐσης περὶ τὸν ἴδιον δαίμονα πραγματείας, τῆς μὲν θεουργικῆς, τῆς δὲ τεχνικῆς, καὶ τῆς μὲν ἀπὸ τῶν ἄνωθεν αἰτιῶν αὐτὸν ἐπικαλουμένης, τῆς δὲ ἀπὸ τῶν ἐν τῇ γενέσει φανερῶν περιόδων, καὶ τῆς μὲν οὐδὲν προσχρωμένης γενεθλιαλογίᾳ, τῆς δὲ ἐφαπτομένης καὶ τῶν τοιούτων μεθόδων, καὶ τῆς μὲν ὑπὲρ τὴν φύσιν καθολικώτερον, τῆς δὲ μεριστῶς κατὰ τὴν φύσιν αὐτὸν θεραπευούσης, ἀτόπως μοι σὺ δοκεῖς τὴν τελειοτέραν ἱεουργίαν ἐπὶ τὴν ἀνθρωπίνην ὑπενεχθῆναι καὶ ἐπὶ ταύτης γυμνάσαι τὰς σαυτοῦ ἐρωτήσεις. (trans. Clarke/Dillon/Hershbell, modified. They have missed the obvious astrological terminology in this passage, translating *genesis* [nativity] as 'generated realm' and *genethliologia* [natal astrology] as generic 'horoscopes and suchlike' rather than the specific branch of *natal* astrology [as opposed to *katarchic*, which Iamblichus seems to favour, or universal/mundane astrology]).

57 (Des Places): ... μοι φαίνει βραχὺ τι μόριον τῆς περὶ αὐτὸν πραγματείας ἀποτεμέσθαι· εἰωθότων γὰρ τῶν περὶ τὴν φύσιν ἐργοτεχνιῶν ἀπὸ τε τῶν δεκανῶν καὶ τῶν λειτουργῶν, ζῳδίων τε καὶ ἄστρον, ἡλίου τε καὶ σελήνης, καὶ ἀπὸ τῶν ἄρκτων, ἀφ' ὧν τε τῶν στοιχείων καὶ ἀπὸ τοῦ κόσμου καλεῖν αὐτὸν τεταγμένως, οὐκ ὀρθῶς σὺ κατανειμάμενος ἔν τι βραχύτατον τὸ τοῦ οἰκοδεσπότης μόριον, περὶ αὐτὸ τὰς ζητήσεις ἐποίησας. (trans. Clarke/Dillon/Hershbell).

in addition to astrology. His remark about the personal daimon, cited earlier (242), makes this clear:

If I am to reveal to you the truth about the personal daimon, it is not from one part only of the heavenly regions nor from any one element of the visible realm that this entity is imparted to us, but from the whole cosmos and from the whole variety of life within it and from every sort of body. . . . (DM IX.6, 280.1–4)⁵⁸

He continues:

. . . For the personal daimon does not guide just one or another part of our being, but all of them at once, and it extends to the whole administration of us, even as it has been allotted to us from all the regions of the universe. And indeed the evidence that you adduce concerning daimons presiding over various parts of the body which attend to their health and condition, and then a single overseer established over all in common, this you may take as an indication of the supervisory role granted to a single daimon over everything that concerns us; do not therefore make a distinction between one daimon concerned with the body, another with the soul, and another with the intellect. (*Letter to Anebo*, 16a = DM IX.7, 281.6–13)⁵⁹

Here Iamblichus seems to say that an *oikodespotēs* is a daimon; he also warns Porphyry against seeing the personal daimon as anything less than an overall ruler (and implies that astrology ignores a single overseer in favour of lesser

58 (Des Places): Εἰ δὲ δεῖ σοι τὸν ἀληθῆ περὶ τοῦ οἰκείου δαίμονος λόγον ἀποκαλύψαι, οὐκ ἀφ' ἑνὸς μέρους τῶν ἐν τῷ οὐρανῷ οὐδ' ἀπὸ τινος στοιχείου τῶν ὀρωμένων ἀπονέμεται ἡμῖν οὗτος, ἀφ' ὅλου δὲ τοῦ κόσμου καὶ τῆς παντοδαπῆς ἐν αὐτῷ ζωῆς καὶ τοῦ παντοδαποῦ σώματος. . . . (trans. Clarke/Dillon/Hershbell).

59 (Des Places): Οὐ γάρ τινος τῶν ἐν ἡμῖν μέρους, πάντων δ' ἅπαξ ἀπλῶς ἡγείται, διήκει τε ἐπὶ πάσαν τὴν ἐφ' ἡμῖν ἀρχήν, ὥσπερ ἀφ' ὅλων τῶν ἐν τῷ παντὶ διατάξεων ἀπονενέμηται. Καὶ γὰρ ὅπερ σὺ παρατίθεις τεκμήριον τὸ περὶ τῶν κατὰ μέρη τοῦ σώματος ἐφεστηκότων δαιμόνων ὑγείας καὶ τοῦ εἶδους καὶ τῆς ἕξεως τῆς ἐν αὐτοῖς ὄντων συνοχέων καὶ ἐνὸς τοῦ ἐπὶ πᾶσι κοινῶς ἐπιβεβηκότος προστάτου, τοῦτο ποιοῦ δείγμα τῆς εἰς ἕνα δαίμονα πάντων τῶν ἐν ἡμῖν ἀνηκούσης προστασίας· μὴ τοῖνον διαίρει τὸν μὲν σώματος τὸν δὲ ψυχῆς τὸν δὲ νοῦ δαίμονα. (trans. Clarke/Dillon/Hershbell). By extension, then, all *oikodespotai*, both overall rulers and those concerned with specific areas, are daimons. For the different types of *oikodespotai*, see below, 2.1–2.8 and Table 7.1, 265–66.

oikodespotai).⁶⁰ But Porphyry's position as an astrologer is that astrological analogues of the personal daimon can be found in the chart, and they are overall chart rulers.⁶¹ Astrology has an abiding interest in finding 'administrators' who oversee the chart, along with an interest in daimons and where they fit into an astrological scheme.

Incidentally, these passages⁶² show that Iamblichus was better versed in astrology than Plotinus. He knows about the decans. The 'servitors' (*leitourgoi*) are the daimons associated with the decans (decan stars are called *leitourgoi* in *SH* VI.12).⁶³ There are references to decans and ministers in the *Pistis Sophia*,⁶⁴ Firmicus Maternus (II, 4.4–5) and Anubio.⁶⁵ The 'Greater and Lesser

60 The *oikodespotēs* ruling over a particular area of life is not the same as the *oikodespotēs* of the nativity which imparts the personal daimon astrologically.

61 See *Introduction to the Tetrabiblos*, ch. 30, discussed below. Broze and Van Liefferinge, 'Le démon personnel', 68, 77 conclude that Porphyry doubts that astrologers can discover the personal daimon from the master of the house, but they seem unaware of Porphyrian material on astrology and his interest in finding the personal daimon in the birthchart (as in ch. 30, and in *On What is Up to Us*). It is also evident that they do not understand the astrological uses of the *oikodespotēs*. Regarding my assertion that Porphyry was an astrologer as well as a philosopher (the two are *not* mutually incompatible), I strongly disagree with the assumption of A. P. Johnson, *Religion and Identity in Porphyry*, 113, 170–72, that Porphyry the philosopher could only write about astrology out of intellectual interest and with a 'critical attitude'.

62 He refers to similar astrological techniques also at VIII.4, 266.

63 *SH* VI.12 (Nock and Festugière, *CH* III, 36): ἔτι καὶ ἐν οὐρανῷ φερόμενοι ἀστέρας γεννῶσιν αὐτοῖς ὑποleitourγούς, <οὐς> καὶ ὑπηρέτας καὶ στρατιώτας ἔχουσιν. 'Moreover, as they [the Decan gods] move in heaven, they engender stars for themselves called servitors, whom they have as servants and soldiers'. See also Chapter 6, 3.3. There are decan gods as *liturgi* in Martianus Capella, *De Nuptiis Philologiae et Mercurii*, 11.200 (Willis, 54.21). Stahl et al. in Martianus Capella, *Martianus Capella and the Seven Liberal Arts*, trans. and annot. William Harris Stahl, Richard Johnson, and E. L. Burge, 2 vols., vol. 2, *The Marriage of Philology and Mercury* (New York: Columbia University Press, 1977), here II, 2, 60, translate *liturgi* as 'attendants'.

64 I, 45.8 (Schmidt/MacDermot, translation 77, Coptic 76.7–8, 11–14): I will fulfil you in all the mysteries of the light, and every *gnosis* . . . from all the gods [ἡνοῦγτε] to the demons [ἡδαίμονιον]; from all the lords [ἡξοεῖς] to the decans [ἡδεκανός]; from all the authorities [ἡεξογεία] to the ministers [ἡλιγογροῖς]; from the creation of men to (that of) beasts. . . . MacDermot's translation, slightly modified (other references to decans as ministers at I, 1; I, 8 and IV, 136). See also Chapter 5, 2.3.

65 Frs 1 and 2 (Obbink, 23–25). Discussed with the Firmicus passages in Chapter 6, 4.4.

Bear' refers to an Egyptian Hermetic practice detailed both in the astrologer Manetho⁶⁶ and in the *Hermetica*.

Manetho: . . . and the course of the signs about the pole which, / in its half journey along the earth and the etherial path, dividing / the moving (celestial bodies) in two, arranges the god-devised universe / from dawn to night and from rising to setting. For these things, / (which come) from the temple sanctuaries, the nature of the ether-roaming / planets has established for men who conjecture rightly about the stars, / for whom the chorus of the cosmos is determinative of Fate for mortals.⁶⁷

Hermetica: And under these [decans] is the constellation called the Bear, composed of seven stars centrally located in regard to the zodiac. Overhead it has another Bear matching it. The activity of the Bear is like that of an axle, never setting or rising, but remaining in the same place, revolving around the same [point], activating the life-bearing circle . . . transmitting the whole [world] from night to day, and from day to night.⁶⁸

Iamblichus also, evidently, has some knowledge of the techniques used to find a 'housemaster', since he reminds Porphyry 'of the clear methods for its discovery . . . when in doubtful cases they [*the Chaldeans and Egyptians*] set out for their elucidation in some cases five elements, in others even more

66 Manetho does not specifically mention the Bear, but his passage has many points of similarity with the *Hermetica* passage, which does. It seems clear he had either read this passage or a similar text, or both he and the author of the *Hermetica* passage were drawing from the same source. In any case, the Bear revolves around the *pole* which is central to Manetho's point.

67 *Apotelesmatica*, IV.5–11 (Lopilato, 75): ζωιδίων τε πόλοιο περί δρομον, δε κατά γαίαν / αιθερίην τε κέλευθον ἐν ἡμιτμητί πορείῃ / πλαγκτὰ διχαζόμενος διέπει θεομήστορα κόσμον / ἐξ ἡοῦς ἐπὶ νύκτα καὶ ἀντολῆς ἐπὶ δυσμᾶς. / ταῦτα γὰρ ἐξ ἱερῶν ἀδύτων φύσις αιθερόπλαγκτων / ὀρθὰ τεκμαιρομένοισι διώρισεν ἀνδράσιν ἄστρα, / οἷς πλαγκτὴ κόσμοιο βροτοκλώστειρα χορεῖη. Trans. Lopilato, 239.

68 *SH VI.13* (Nock and Festugière, *CH III*, 37): ὑπὸ δὲ τούτους ἐστὶν ἡ καλουμένη ἄρκτος, κατὰ μέσον τοῦ ζωδιακοῦ ἐξ ἀστέρων συγκειμένη ἑπτὰ, ἔχουσα ἀντίζυγον ἑτέραν ὑπὲρ κεφαλῆς. ταύτης μὲν ἡ ἐνέργειά ἐστι καθάπερ ἄξονος, μηδαμοῦ μὲν δυσούσης μηδὲ ἀνατελλούσης, μενούσης δὲ ἐν τῷ αὐτῷ τόπῳ αὐτῆς περὶ <τὸ> αὐτὸ στρεφομένης, ἐνεργούσης δὲ τὴν ζωοφόρου κύκλου <. . .>, παραδιδούσα τὸ πᾶν τοῦτο ἀπὸ μὲν τῆς νυκτὸς ἡμέρα, ἀπὸ <δ'> ἡμέρας νυκτὶ. My translation after W. Scott, ed. and trans., *Hermetica*, I, 412–13.

than that, while in others less?’⁶⁹ These ‘five elements’ must refer to the steps used by astrologers to find an *oikodespotēs* (see, e.g., the technique of Ptolemy, below, 2.3, 259–60).⁷⁰ Furthermore, Iamblichus uses the word ‘ἐπικράτεια’ in relation to the daimon (*DM IX.2*, 274.8); the astrological technique of ‘predomination’ is involved in the discovery of the *oikodespotēs*, as we shall see.

There is one more area where astrology overlaps with theurgy, and that is the use of material objects such as statues in theurgic rites.⁷¹ The statue is literally imbued with the divine essence of the god it represents.

Since it was necessary that earthly things not be deprived of participation in the divine, the earth received a certain divine portion capable of receiving the Gods. The theurgic art, therefore, . . . often twines together stones, herbs, animals, aromatics, and other sacred, perfect, and deiform objects of a similar kind. Then, from all these it produces a perfect and pure receptacle.⁷²

Porphyry’s treatise *On Statues* (*Περὶ ἀγαλμάτων*), surviving in fragments,⁷³ gives a context for this kind of practice. Astrology was often used to determine the right moment for consecrating statues and other holy images, and the proper astrological moment was based on characteristics, both astrological and religious/mythological, of the deity in question; see particularly Hephaestio

69 *DM*, IX.5, 279.2–5 (Des Places), trans. Clarke/Dillon/Hershbell, slightly modified): ὁπότε μεθόδους παραδεδώκασι περὶ τῆς εὐρέσεως αὐτοῦ σαφεῖς, ἐπὶ τε τῶν ἀμφισβητουμένων στοιχεῖα πρὸς τὴν διάκρισιν ἀναδιδάσκουσιν οἱ μὲν πέντε οἱ δὲ καὶ πλείονα τούτων οἱ δὲ ἐλάττωνα.

70 Recapitulated by Hephaestio (I, 13.2). Both T. Gale, in Iamblichus, *Iamblichus Chalcidensis ex Coele-Syria, De mysteriis liber Præmittitur epistola Porphyrii ad Anebonem Ægyptium, eodem argumento*, ed. Thomas Gale (Oxford: E theatro Sheldoniano, 1678), 312 (n. to p. 168.25) and T. Taylor, in Iamblichus, *Iamblichus on The Mysteries of the Egyptians, Chaldeans and Assyrians*, trans. Thomas Taylor (London: Stuart and Watkins, 1821, repr. 1968), 319, cite Hephaestio for this passage, but of course he was later than Iamblichus.

71 See Shaw, *Theurgy and the Soul*, 47–48. Addey, *Divination and Theurgy*, 252–55, argues persuasively for Iamblichus’s sanction of statue divination.

72 *DM*, V.23, 233.6–9, 11–13 (Des Places), trans. Shaw (slightly modified), 47–48: ἐπεὶ γὰρ ἔδει καὶ τὰ ἐν γῆ μηδαμῶς εἶναι ἄμοιρα τῆς θείας κοινωνίας, ἐδέξατο τινα ἀπ’ αὐτῆς θεῖαν μοῖραν καὶ ἡ γῆ, ἱκανὴν οὖσαν χωρῆσαι τοὺς θεοὺς. . . ἡ θεουργικὴ τέχνη. . . συμπλέκει πολλάκις λίθους βοτάνας ζῶα ἀρώματα ἄλλα τοιαῦτα ἱερά καὶ τέλεια καὶ θεοειδῆ, κάπειτα ἀπὸ πάντων τούτων ὑποδοχὴν ὀλοτελῆ καὶ καθαρὰν ἀπεργάζεται.

73 Drawn from Eusebius, *PE*, collected in J. Bidez, *Vie de Porphyre: Le philosophe Néoplatonicien* (Ghent/Leipzig: E. Van Goethem/B. G. Teubner, 1913).

(fl. early fifth century), and Julian of Laodicea (ca. 500 CE).⁷⁴ While it would be speculative to infer any theurgic tendencies on the part of Hephaestio and Julian, it is evident that the involvement of astrology in the consecration of statues was not uncommon in this period.

1.3 *Porphyry*

Porphyry is the link between Plotinus and Iamblichus. Plotinus was his teacher, and Porphyry organised and disseminated what is known as the *Enneads*. Iamblichus may have studied with Porphyry (or been a fellow colleague), but the two had intellectual, philosophical and religious differences, as evident from Iamblichus's responses to Porphyry's *Letter to Anebo*. Porphyry was an intellectual eclectic—highly curious, not fixed in his intellectual opinions (compared to Plotinus and Iamblichus), not afraid to ask questions and perfectly willing to admit his own ignorance in certain areas. There is something refreshing about his unpretentious attitude. He has been accused of being an intellectual lightweight;⁷⁵ Bidez, who wrote an early study of him and his work, thinks he was spoiled by his flexibility.⁷⁶ But ultimately these perceptions are unfair, and recent scholarship has rehabilitated his intellectual powers.⁷⁷

Several of Porphyry's treatises deal with both daimons and astrology (*Letter to Anebo*, *On What is Up to Us*, *Philosophy from Oracles*,⁷⁸ *The Cave of the Nymphs in the Odyssey*). *On Abstinence* deals in part with daimons of all kinds; and he is the presumed author (of most chapters) of the astrological treatise *Introduction to the Tetrabiblos* (see below, Section 3, 'Porphyry's Astrological Treatise', esp. nn. 122–125). We may thus consider him knowledgeable, even expert, in these two fields.

74 See Hephaestio, III, 7.13–18 (Pingree, 258–59); and for Julian, *CCAG* VIII/4, 252.6–22. For more on astrology and the consecration of images, see Pérez Jiménez, 'Hephaestio and the Consecration of Statues'.

75 Dodds, *Greeks and the Irrational*, 286–87: 'no consistent or creative thinker'.

76 Bidez, *Vie de Porphyre*, 132: 'Le travail de Porphyre nous révèle un génie victime de sa curiosité et gâté par trop de souplesse.' He continues in the same vein, 133–34.

77 E.g., Hornblower and Spawforth, eds, *Oxford Classical Dictionary*, s.v. 'Porphyry'; P. Athanassiadi, 'Dreams, Theurgy and Freelance Divination: The Testimony of Iamblichus', *JRS* 83 (1993): 115–30, here 117–18; the Introduction in G. Karamanolis and A. Sheppard, eds., *Studies on Porphyry* (London: *BICS* Supplement 98, 2007), 4–5; Smith, 'Porphyry—Scope for a Reassessment' in *Studies on Porphyry*, 7; Clarke, Dillon and Hershbell in Iamblichus, *On The Mysteries*, Introduction, xxx–xxxii. For scholarship on Porphyry in the 20th century up to 1987, see Smith, 'Porphyrian Studies Since 1913'.

78 For a discussion of the astrology in *Phil. Orac.*, see Addey, *Divination and Theurgy*, 117–24.

2 The Astrological Personal Daimon

Arguably the most important astrological issue for Porphyry is how to find the personal daimon in the birthchart. We have seen Iamblichus's response to Porphyry's questions about the personal daimon. We have not, however, looked at this issue from Porphyry's standpoint. From his statements in the essay *On What is Up to Us*, Porphyry's interest in applying Plato's concept of the personal daimon from the Myth of Er to the astrological chart is plain. He believes each incarnated soul enters into the chosen life, with her daimon ratifying the chosen life, at the appropriate astrological moment.⁷⁹

Porphyry is convinced of a connection between the personal daimon and the analogue of that daimon which can be found in the birthchart. For him, this analogue is found by determining the predominator and the οἰκοδεσπότης γενέσεως, the 'housemaster of the nativity', and from that the lord of the nativity.⁸⁰

2.1 *Master of the House: Definitions and Context*

In Hellenistic culture, connotations of the word *oikodespotēs* encompass not only the literal 'master of the house', i.e. the ruler of the household in the private sphere of the home, but by extension a general ruler or lord. In the New Testament, it is used not just for the master of a household but allegorically for God: for example, the vineyard-owning *oikodespotēs* of the parable in Matthew 21:33–41 is an allegory for the Lord.⁸¹ Broader connotations of *oikodespotēs*

79 'Περὶ τοῦ ἐφ' ἡμῖν', Wachsmuth, II, 164.8–13; 171.20–24 = Smith, 296.16–297.1 (268F); 306.89–92 (271F) = Wilberding, *To Gaurus*, 143, 146. This last passage emphasises the connection of the astrological Ascendant, the sign and degree on the eastern horizon at the moment of birth, with the chosen life and the accompanying daimon. (See also Chapter 6, 2.1, for similarities in *Hermetica*).

80 Porphyry, *Introduction to the Tetrabiblos*, CAG V/4, 206.3, ch. 30.1 (= ὁ οἰκοδεσπότης τῆς γενέσεως at DM IX.5, 278.12–13 [*Letter to Anebo* 15c]).

81 This is made clear in 21:40 when the '*oikodespotēs*' of the vineyard becomes a '*kurios*'. Matt. 21:33 (King James Version): 'Hear another parable: There was a certain householder (*oikodespotēs*), which planted a vineyard, and hedged it round about, and digged a winepress in it, and built a tower, and let it out to husbandmen, and went into a far country . . . 21:40: 'When the lord (*kurios*) therefore of the vineyard cometh, what will he do unto those husbandmen?' (The Biblical definitions cited and discussed by G. Bezza, 'Astrological Considerations on the Length of Life in Hellenistic, Persian and Arabic Astrology', *Culture and Cosmos* 2, no. 2 (1998): 3–15, here 5 and n. 5.).

appear in its astrological use.⁸² An astrological *oikodespotēs* is not just the ruler of a zodiac sign (its ‘house’), but can also apply to any ‘familial’ tie a planet has.⁸³ In astrology, the term seems to have four meanings (some with variations):⁸⁴

- 1) **1a)** the ‘house-lord’ of a sign, planet or place (e.g. the house lord of Jupiter in Taurus is Venus; Venus is the house-ruler of Taurus);⁸⁵
 - 1b)** ‘Co-housemasters’ (*sunioikodespotai*), defined as planets co-ruling signs where they have house, exaltation or triplicity in common, e.g. Sun and Mars in Aries;
 - 1c)** the luminaries are also said to be general co-housemasters;⁸⁶
- 2) **2a)** a planet having more counts of rulership in a particular degree or place of the chart, thus ruling over that one area or aspect of life;
 - 2b)** a planet having more counts of rulership over several planets/positions in the chart (this planet must also be in ‘aphetic places’);

82 In LSJ, s.v., five of the nine meanings for *oikodespotēs* and its derivatives are astrological in nature.

83 Bezza, ‘Length of Life’, 5. ‘It therefore does not depend on οἶκος in the sense of planetary domicile or “house” as defined by its walls, but as the “hearth”, the home, the family as defined by blood ties.’

84 Unfortunately, the astrological texts do not always make the distinctions clear with every use; they must be distinguished by context.

85 See, e.g. Dorotheus (Pingree, 329.3, 406.6, 421.8). These are a few of many examples in astrological writings.

86 Porphyry, *Introduction*, CCAG V/4, 197.11–22 (≈ Antiochus, *Introduction*, ch. 5, CCAG VIII/3, 113.14–22; cf. also Antiochus, *Thesaurus*, ch. 32; a similar passage also in Hephaestius, I 13.1 [Pingree, 39.16–18]): Συνοικοδεσπότηται δ’ ἀλλήλων λέγονται, ὅταν τοῦ μὲν οἶκος ᾗ, τοῦ δὲ ὕψωμα. τινὲς δὲ τοὺς τῶν οἴκων καὶ τοὺς τῶν τριγῶνων κυρίου συνοικοδεσπότητας λέγουσιν, οἶον Κριοῦ Ἥλιος καὶ Ἄρης, Ταύρου Σελήνη καὶ Ἀφροδίτη, Διδύμων Ἑρμῆς καὶ Κρόνος, Καρκίνου Ζεὺς καὶ Σελήνη, Ζυγοῦ Κρόνος καὶ Ἀφροδίτη, Σκορπίου Ἄρης μόνος, Τοξότου Ζεὺς καὶ Ἥλιος, Αἰγυγίου Ἄρης καὶ Κρόνος, Ὑδροχόου Κρόνος καὶ Ἑρμῆς, Ἰχθύων Ἀφροδίτη καὶ Ζεὺς. ὁμοίως δὲ καὶ ἐπὶ τῶν λοιπῶν. φωστήρας καὶ φῶτα καὶ βασιλεῖς λέγουσιν Ἥλιον καὶ Σελήνην καὶ τὸν μὲν ἡμέρας, τὴν δὲ νυκτὸς κυρίου. ἐν ταῖς συνοικοδεσποτήταις τοὺς τῆς αἰρέσεως λέγουσι φωστήρας, ἐν οἷς ὕψωμά τινας λαβεῖν οὐκ ἔστι. ‘They are said to be co-housemasters of each other when the house of one is the exaltation of the other. Some say the co-housemasters are the lords of the houses and the triplicities, such as the Sun and Ares in Aries, the Moon and Aphrodite in Taurus, Hermes and Kronos in Gemini, Zeus and the Moon in Cancer, Kronos and Aphrodite in Libra, Ares alone in Scorpio, Zeus and the Sun in Sagittarius, Ares and Kronos in Capricorn, Kronos and Hermes in Aquarius, Aphrodite and Zeus in Pisces; also in like fashion for the rest. They say also that the Sun and Moon are the light-givers, luminaries and kings, and he is lord of the day, she of the night; they say the light-givers are in co-housemastership of the sect, in which one is not to be exalted over the other.’

- 3) a planet ruling the bounds of a predominating planet; or
- 4) an overall ruler of the chart.

Many Hellenistic astrologers mention the *oikodespotēs*.⁸⁷

The *oikodespotēs* is an old term in Hellenistic astrology. It is mentioned in the fragments (quoted by later astrologers) of Nechepso and Petosiris,⁸⁸ some of the earliest astrologers whose writings we possess. One of these fragments is found in the summaries of Antiochus of Athens:⁸⁹

But as Nechepso says, and to which Petosiris also agrees with the king, the things being sought turn out to be understood from the examination of both the housemaster and the lord. For the housemaster on the one hand [deals with] the length of human lifetimes, but the lord, on the other hand, the type of life of those about to come into existence.⁹⁰

87 A *TLG* search on 'oikodespot' yielded the names of Ptolemy, Vettius Valens, Antiochus, Dorotheus, Porphyry, Hephaestio, Rhetorius, Olympiodorus (called 'Heliodorus'), Paulus, Julian of Laodicea, Serapion, Antigonos, Protagoras and Deucalion as well as Arabic-era astrologers Theophilus, Māshā'allāh, Abū Ma'shar and the pseudonymous 'Palchus'. The *TLG* does not have Riess's fragments of Nechepso-Petosiris (see n. 88).

88 First collected in Nechepso and Petosiris, *Fragmenta magica*, ed. Riess. (Note: these fragments have been revised and augmented by S. Heilen, 'Some metrical fragments from Nechepsos and Petosiris', in *La poésie astrologique dans l'Antiquité*, ed. Isabelle Boehm and Wolfgang Hübner (Paris: De Boccard, 2011).

89 *CCAG* VIII/3, 104–19 contains summaries of Antiochus's *Thesaurus* and *Introduction*. A summary of four chapters of a 'second book', says D. Pingree, 'Antiochus and Rhetorius', *CPh* 72, no. 3 (1977): 203–23, here 206, 'probably belongs to a work other than Antiochus' *Εἰσαγωγικά*, but it follows the summary of the first book of the *Introduction*.

90 *CCAG* VIII/3, 119.25–29 (not in Riess; = fr. +18 in Heilen, 'Metrical Fragments', 33): φησὶν δὲ ὡς Νεχεψῶ τε τῷ βασιλεῖ, ᾧ καὶ Πετόσιρις συμφωνεῖ, ἐκ τῆς διασκέψεως τοῦ τε οἰκοδεσπότου καὶ τοῦ κυρίου εἰς κατάληψιν τὰ ζητούμενα πίπτει. καὶ γὰρ τὸν μὲν οἰκοδεσπότην τὸν ζωτικὸν ἀνθρώπων χρόνον, τὸν δὲ κύριον τῶν συγκυρεῖν μελλόντων τὸν βίον. Here my translation uses συγκυρεῖν as Cumont doubtfully suggests (119, *app. crit.* to ll. 28–29: 'συγκυρεῖν cod. Leg. συγκυρεῖν?'). He ultimately decides on συγκυρεῖν as a variant of συγκυραίνω, a form of κηραίνω, destroy. LSJ s.v. συγκυρέω gives the 'destroy' meaning and cites this very text. (The translation would then read 'the lord destroys the life of those about to be'.) The 'destroy' meaning could connect with the idea of an *anairetēs*, a planet which cuts off a life. Unfortunately the confusion between verbs is symptomatic of the confusions and variations which arise with delineating the doctrine of the *oikodespotēs*. But my interpretation, using συγκύρω, 'happen', 'occur', makes more sense here, especially if we think of the lord of the nativity ruling over the *kind* of life the native lives, which fits with Porphyry's idea that one of these overall chart rulers connects to a personal daimon guiding a human through life. This theory is given some reinforcement by the use of ζωτικὸν

It is found as well in some of the earliest extant charts: in *Greek Horoscopes*, the charts numbered 15/22, 81, 95, 137a and b and 138/161 make references to the *oikodespotēs* of the nativity.⁹¹ L76 (the chart of the Emperor Hadrian) refers, in determining the length of his life, to the *oikodespotēs* of the Moon.⁹² One of the ‘deluxe’ horoscopes in *APO*, no. 4278, mentions an *oikodespotēs* and a *sunoikodespotēs*.⁹³ Of the Hellenistic astrologers, Dorotheus, Ptolemy, Vettius Valens, Antiochus, Firmicus Maternus, Paulus Alexandrinus, his commentator Olympiodorus, Hephaestio, Serapion and Rhetorius all provide instructions for determining an *oikodespotēs* of one kind or another. Often it is associated with determining life expectancy. Porphyry is not particularly eccentric in his methods for the *oikodespotēs* (although his motives may be different). We shall look at some other astrologers’ methods before examining Porphyry’s in more depth.

2.2 Dorotheus’ Oikodespotēs

The techniques Dorotheus uses for finding rulers of the chart appear in the Arabic translation of his work (111, 1 and 2), and in a Greek fragment preserved in Hephaestio (11, 26). Unfortunately, they are somewhat opaque (possibly Dorotheus was one of the astrologers whom Porphyry meant when he said, ‘For the ancients entangle the names up and do not distinguish their characteristics’).⁹⁴ The Greek fragment refers only to a ‘releaser’ (*aphetēs*), not calling it by any other name, though he seems to mean something like Porphyry’s ‘predominator’. The Arabic version calls the releaser the *haylāj*

χρόνον (the same phrase used by Vettius Valens of the *epikratētōr* in 111, 1.1) in regard to the *oikodespotēs*, but βίον in regard to the *kurios*. (Porphyry’s treatise *On What is Up to Us* makes the same distinctions between ζώη and βίος [Wachsmuth 11, 163.16–167.7 = Smith, 295.1–300.104 (268F); Wilberding, *To Gaurus*, 141–43].) On this distinction in Porphyry’s essay see Festugière’s translation and commentary in his *Proclus, Commentaire sur la République*, vol. 3, 349 n. 2.).

91 Citations in *GH*: for 138/161:10, 13, [15]; 15/22:16; 81:163; 95:[79]; 137a:42; 137b:41. In literary charts: L40 (Antigonus ap. Hephaestio), L76 (Antigonus ap. Hephaestio), L13,1V (Antigonus ap. Hephaestio), L482 (Rhetorius). In *kataarchai*: L486 and L487. See Appendix 7.A for analysis of the *oikodespotai* of these charts.

92 See *GH*, 90. This section about the *oikodespotēs* does not appear in Pingree’s critical edition of Hephaestio, but it does appear in *CCAG* VI, 68.4–9 and was included by Neugebauer and Van Hoesen in *GH*. See Appendix 7.A. For charts from Antigonus of Nicaea, see Heilen, *Hadriani genitura*, F2 § 54.

93 Jones, *Astronomical Papyri from Oxyrhynchus*, vol. 1, 286–87; vol. 2, 426–27 (No. 4278). See Appendix 7.A.

94 Porphyry, *Introduction*, 206.4–5.

(Medieval 'hyleg') and the *oikodespotēs* the *kadhkhudāh* (Medieval 'alcocoden'). The *haylāj* is the 'indicator' and the *kadhkhudāh* the 'governor of the matter of life'.⁹⁵

To find the *haylāj*, one looks first at the Sun by day and the Moon by night, but if they are not suitably placed, one looks in turn at the Lot of Fortune, the prenatal lunation (whether new or full), or the lord of the Ascendant.⁹⁶ The Greek fragment and the Arabic text both insist that the *haylāj* be aspected by one of its lords (either its house, exaltation, triplicity or bound lord). Once the *haylāj* is determined, its bound-lord becomes the *kadhkhudāh*. The technique is clarified by an example in Dorotheus (III, 2.19–25),⁹⁷ where the Ascendant is the *haylāj* and its bound lord, Mars, is the *kadhkhudāh*.

2.3 Ptolemy's Oikodespotēs

Ptolemy uses the concept of a 'housemaster' to apply in a number of different areas, including length of life, quality of soul, eclipses, action/profession etc. The general principle is outlined in Book II, 8.2–4, in reference to eclipses. Ptolemy explains that one finds a planet with the most relationships in a certain position (here, the place of an eclipse). These relationships, relations or claims (the slippery Greek word *logos*) consist of the rulerships by house (sign), triplicity, exaltation and bound that the planet holds in that position, as well as the phase or configuration (aspect) it makes. For the phase or configuration, Ptolemy is interested in the 'visible applications or separations'. If two (or more) planets have the same number of claims to rulership, he looks for the one which is closest to an angle, in a more productive place, or in the sect of the chart.

95 Dorotheus III, 2.2 (Pingree, 242). The Arabic description of III, 1 (Pingree, 235) also uses the terms 'indicator' and 'governor' for *haylāj* and *kadhkhudāh*.

96 In fact, this procedure has certain similarities with Porphyry's instructions for finding the lord of the nativity, where a list of candidates includes the lord of the Lot of Fortune, the bound-lord of the preceding lunation and the lord of the Ascendant. But Dorotheus uses this list sequentially to find the *haylāj/apheta*, not the lord of the nativity.

97 Pingree dates this chart to ca. 7 a.m., 20 October 281. But J. H. Holden, *A History of Horoscopic Astrology from the Babylonian Period to the Modern Age* (Tempe, AZ: American Federation of Astrologers, 1996), 34, n. 83 suggests 'a better fit to the positions given in the text is 2 October 44, which is also consistent with the dates of Dorotheus's other example charts.' A check of this chart (2 October 44, ca. 8:00 a.m.) in a modern calculation program (Solar Fire v. 5.1) shows agreement with Dorotheus's positions by sign, though not by degree (Pingree's suggested date gives a different sign for Venus and Mercury). (See this chart in a Latin version in Hugo of Santalla, *The Liber Aristotilis of Hugo of Santalla*, ed. Charles Burnett and David Pingree, (London: The Warburg Institute, 1997), 8, 44–46.

In Book III, 3, similar directions for finding an *oikodespotēs* are given (in reference to finding the Ascendant degree): ‘...to see the stars which have a relationship as housemaster to it, generally the method for observing the house-mastership is in these five [ways]: by both triplicity and house, exaltation, bound and phase or configuration.’⁹⁸

The determinations of the *oikodespotēs* in both ways Ptolemy uses it are what would be known as finding an almuten (Arabic *al-mubtazz*) in Medieval astrology. They accord with meaning #2a.

III, 11 gives doctrine on the length of life, ‘taken in complex ways from the predomination of the most authoritative places.’⁹⁹ This involves finding a ruling planet from certain positions (Sun, Moon, Ascendant, Prenatal Syzygy, Lot of Fortune)¹⁰⁰ when placed in ‘aphetic’ places (roughly corresponding to the first, eleventh, tenth, ninth and seventh places). For a day chart, one would favour the Sun, if in aphetic places; for a night chart, the Moon (also in aphetic places); but if not, the preceding syzygy and the Ascendant; the planet with the most ‘relations’ is the *oikodespotēs*. Note the use of the word ‘predomination’ (*epikratēsis*). This technique is similar to Dorotheus’s for finding (in the Arabic version) the *haylāj* (releaser, or *aphetēs*, in Dorotheus ap. Heph. II, 26). This is meaning #2b.

2.4 Valens’ Oikodespotēs

Valens, as well, works with different concepts of an *oikodespotēs*. In Book II, 41 of the *Anthology*, he quotes Petosiris’s description of the *oikodespotēs*:

Beginning, end, power over all the places under close investigation¹⁰¹—the star ruling as house-master in each nativity which, for those being born, makes clear beforehand whoever will be part of life and the quality of support they have for it, what kind of habits they will have, the type of bodily form, all of which come to be consequent from this [star].

98 III, 3.3 (Hübner, 174.141–45):... ἰδεῖν τοὺς πρὸς αὐτὴν οἰκοδεσποτικὸν λόγον ἔχοντας τῶν ἀστέρων, τοῦ τρόπου καθόλου τοῦ κατὰ τὴν οἰκοδεσποτείαν ἐν πέντε τούτοις θεωρουμένων (τριγώνω τε καὶ οἴκῳ καὶ ὑψώματι καὶ ὀρίῳ καὶ φάσει ἢ συσχηματισμῶ.... Note the ‘five’ as similar to Iamblichus’s ‘five elements’.

99 III, 11.2 (Hübner, 202.555–56):... τῆς τῶν κυριωτάτων τόπων ἐπικρατήσεως πολυμερῶς λαμβανόμενος.

100 Considered in order by strength of their positions, starting with the Sun by day and the Moon by night.

101 διοπτρευτήριον. A *hapax legomenon* in the *TLG*. LSJ, s.v. says ‘dub. sens.’ and cites this reference. I have tried to convey the sense of something being scrutinised or looked at closely.

Without this [star] there is nothing, neither achievement nor reputation nor anything else.¹⁰²

But Valens is somewhat dubious that one planet will supply the same fortune for every area of life; he prefers to think of either different rulers for different areas of life, or changes over time in the rulership of the planet in question.¹⁰³ (This seems similar to Ptolemy's different *oikodespotai* for different areas of life.) Valens also distinguishes between the planet which gives life and the planet which sustains life: 'So one [planet] was the life-giver, and another <the> lord of the existence and the death.'¹⁰⁴ These are akin to the functions of Dorotheus's *haylāj* and *kadhkhudāh*.

Finding these astrologically is taken up in the next book. First, a method for determining a 'predominator' (ἐπικρατήτωρ) is delineated in III, 1, and from that the *oikodespotēs* is found.¹⁰⁵ The predominator is generally the Sun by day and the Moon by night, but this depends on its placement in the chart—considering its aspects (to the Ascendant or Midheaven), its sect vis-à-vis that of the chart, whether it is in its own triplicity, and the productiveness or effectiveness of the place in which it lies (i.e. an angle, eleventh or fifth, etc.). If the Sun or Moon is not found in a productive place, one can look at the Hourmarker and its lords, or even the Midheaven and its lords. Once the predominator is found, the bound-lord of the predominator becomes the *oikodespotēs* (meaning #3). Valens gives numerous examples of Sun and Moon positions to illustrate the hierarchy of the concept. He also illustrates the technique in actual charts (III, 5); these turn out not to have an *oikodespotēs*, since what would be the *oikodespotai*, the bound rulers of the predominator (in these cases the sect luminary), are not well-placed (L75 and L10,III in *GH*). For Valens, the bound-lord must also be in good condition to be an *oikodespotēs*. (Valens is the only writer aside from Porphyry to give detailed instructions for finding an *epikratētōr*.)¹⁰⁶

102 II, 41.3–4 (Pingree, 118.3–8): 'ἀρχή, τέλος, κράτησις τῶν ὅλων διοπτρευτηρίων—ὁ καθ' ἐκάστην γένεσιν ἀστὴρ οἰκοδεσποτῶν ὅστις πρόδηλα ποιεῖ τοῖς γεννωμένοις ὅτινες ἔσονται τοῦ βίου τε ὑπόστασιν ὅποιαν τινὰ ἔξουσιν, τοῖς τρόποις τε ὅποιοι, σώματος μορφῆς τύπον, ἅ πάντα τοῦ-τω κατακόλουθα γίνεται. τούτου δ' ἀνευθεν οὐδέν, οὔτε πρᾶξις οὔτε δόξα, προσπάρεστιν οὐδενί.'

103 See II, 41.5–20 (Pingree, 118.8–119.26).

104 II, 41.9 (Pingree, 118.26–27): ἕτερος οὖν ὁ ζωοδότης ἐγένετο καὶ ἕτερος <ὁ> τῆς ὑπάρξεως καὶ τοῦ θανάτου κύριος.

105 We discussed this procedure in a different context in Chapter 3, 2.5, 107.

106 If the predominator or *oikodespotēs* is not 'oikeiōs', Valens propounds a technique said to be from Nechepso (III, 7.1–15 = fr. 18 Riess, 360–362; = fr. 18 in Heilen, 'Metrical Fragments', 32); this is a technique for life expectancy involving a lot found using the positions of

In Book VII, 2 Valens lays out a system of determining ‘effective and ineffective’ (*empraktos* and *apraktos*) times of life, using an *oikodespotēs*. It is not entirely clear whether he means an *oikodespotēs* which is the overall lord of the nativity (meaning #4), or whether he is looking at several planets who are house-masters. His first statement seems to mean the former:

For every nativity, when the stars have been set out accurately, it will be necessary to examine how the House-master is configured, or by what [stars] it is witnessed, and if it is in a state of emergence or setting [*i.e. visibility or invisibility with respect to the Sun*], and if it possesses a configuration which is ‘domestic’ or ‘foreign’ to the sect [of the chart]...¹⁰⁷

Yet he continues by saying that ‘in common with this’¹⁰⁸ one must also look especially at the condition of the Lot of Fortune and its lord, then the Ascendant and its lord, planets in the Ascendant, the Midheaven and its lord, and the lords of the other two angles, as well as aspects with the Moon (VII, 2.2–15, Pingree, 252.4–34). It is hard to tell whether he means all of these contribute in some way to the effectiveness of the times, or whether the strongest planet in these positions becomes the *oikodespotēs*. The latter is more in line with Porphyry’s position about the ‘lord’, as we shall see.

2.5 Firmicus’s *Oikodespotēs*

Firmicus gives several different methods for finding the *oikodespotēs* in *Mathesis* IV, 19.2. The Latin phrase *dominus geniturae* translates his transliteration of the Greek, *oecodespotes*, described as controlling ‘the sum of the whole nativity, and from it the individual stars are allotted the license to decree’¹⁰⁹

new and full moons; it is called the Lot of Hyleg by Bonatti. (See the note by R. Hand, ed. in Vettius Valens, *Vettius Valens, The Anthology, Book II (concl.)*, & *Book III*, trans. Robert Schmidt (Berkeley Springs, WV: The Golden Hind Press, 1994), 54 n. 1.)

107 VII, 2.2 (Pingree, 252.1–4): ἐπὶ πάσης γενέσεως ἀκριβῶς τῶν ἀστέρων ἐκτεθέντων σκοπεῖν δεήσει τὸν οἰκοδεσπότην πῶς ἐσχημάτισται ἢ ὑπὸ τίνων μαρτυρεῖται καὶ εἰ ἀνατολικός <ἢ> ἢ δυτικὸς καὶ εἰ οἰκείον σχῆμα ἢ ἀλλότριον τῆς αἰρέσεως κέκτηται. . . .

108 VII, 2.2 (Pingree, 252.4): . . . τὸν τε τούτου ἐπίκοινων. . . .

109 IV, 19.1 (KSZ, I, 243.2–5 = *Monat*, II, 178–79): ‘. . . <geniturae> dominum, quem Graeci oecodespotes vocant, qua debeas ratione colligere; ipse enim totius geniturae possidet summam et ab ipso stellae singulae decreti licentiam sortiuntur. . . .’ *Monat* (179) translates in part: ‘. . . c’est de lui que chacun des astres reçoit son pouvoir de décision’. Firmicus emphasises how pervasive the control of the *oecodespotes* is when he uses two different words for ‘whole’ in the same phrase: *totius geniturae* . . . *summam*.

(meaning #4). The first method says the ‘lord of the geniture’ is any planet dignified both accidentally (by place) and essentially (by house or terms). A second method looks at the term (bound) lord of the Sun by day and the Moon by night. Firmicus acknowledges the logic of this. A third method uses the exaltation ruler of the Moon. A fourth method finds the ruler from the lord of the sign following that in which the Moon is found—a method seen in no one but Firmicus, but which he favours, claiming it is ‘most true and approved by all’.¹¹⁰ For Firmicus, neither the Sun nor the Moon can be the *dominus geniturae* (IV, 19.4).

2.6 Paulus’s Oikodespotēs

Paulus lays out the necessary conditions for the *oikodespotēs* in Chapter 36 (Boer, 95–98). It is found from either the Sun or the Moon, if the Sun and Moon are ‘in the operative places’. These are, in a diurnal chart, the Hour-marker, Midheaven, Good Daimon, Setting and Post-Setting (i.e. eighth) places. By night the operative places are all four angles and the places of Good Fortune, Good Daimon, the post-ascension of the Hour-marker (the second), and the Post-Setting (the eighth) (these are the succedent places). If the Sun or Moon do not fall in any of these, one looks at the bound lord, triplicity lord or house lord of the prenatal syzygy (new or full). If those are not in operative places, one looks at the house, triplicity or bound ruler of the Lots of Fortune and Daimon, as well as the lord of the Hour-marker. These techniques have commonalities with Dorotheus and with Ptolemy, though the latter does not intentionally use the Lot of Daimon. Finally, a planet ruling in these places in aspect with the planet it rules will become the overall ‘authority’ (*kuria*) of the nativity. At one point Paulus calls this ὁ τῆς γενέσεως οἰκοδεσπότης (meaning #4).¹¹¹ (The astrologer Serapion also talks about an ‘authority’ being found from the bound-lord of the Moon, based on whether the Moon is present in the same bounds with its ruler, either applying or separating.)¹¹²

110 Ibid., IV, 19.3 (KSZ, I, 243.28–29 = Monat, II, 179): ‘... haec enim est verissima et ab omnibus comprobata.’ The Renaissance thinker Marsilio Ficino, who had a great interest in the personal daimon, had read both Porphyry’s and Firmicus’s methods for finding the *oikodespotēs* (which Ficino, following Firmicus, calls the ‘*dominus geniturae*’). See *De vita coelitus comparanda*, 23 (Kaske and Clark, 370–77).

111 Ch. 36 (Boer, 97.19–20).

112 CCAG VIII/4, 229.1–3: ἔάν δὲ ὁ κύριος ἐπιτρέχει μοίραις τῶν ὀρίων <καὶ> Σελήνη συμπαρῆ αὐτῷ κατὰ τὰ αὐτὰ ὅρια, εἰ δὲ Σελήνη αὐτῷ συνάπτει, κυρία ἔσται ἢ συναφή· ὡσαύτως ἔάν ἀπορρῆ, κυρία ἔσται ἢ ἀπόρροια.

Olympiodorus's *Commentary*, ch. 40, gives more details on how to do this. When the planet has been found, one looks at how it is positioned in the chart, and what aspects it makes. The *oikodespotēs* is used by Paulus and Olympiodorus in length of life calculations.

2.7 *Hephaestio's Oikodespotēs*

In Book I, 13, Hephaestio summarises the definitions of an *oikodespotēs*. It is the house ruler of a zodiac sign (meaning #1a), but any planet ruling by exaltation, triplicity and/or bound also is a co-*oikodespotēs* (meaning #1b; Antiochus and Porphyry also mention this meaning). Following the rules of Ptolemy, he defines a 'house-master of the nativity',¹¹³ from the 'five' rulerships by house, exaltation, triplicity, bound and 'phase in relation to the Sun'.¹¹⁴ But he does not say how to find the planet for which these should be calculated. However, the passages from Dorotheus on the *aphetēs*, found in Hephaestio's Book II, 26, go into the procedure in much greater detail. The earlier reference may assume a planet in an aphetic place which is free of affliction from malefics: 'In addition to these [rules], it is necessary to examine the aphetic places and discern the one that is delivered from and free of the disturbance of a malefic.'¹¹⁵

Interestingly, and relevant to our discussion of the personal daimon, Hephaestio actually mentions a personal daimon in I, 1. He says that for someone whose Ascendant is in the first decan of Virgo, '... his personal daimon and fortune will take care of him. He will be unhealthy, but will be provided with medical remedies; and after [his] youth he will be kindly treated by a woman and will be provided with a good end of life.'¹¹⁶ If the Ascendant falling in a particular decan has something to do with the personal daimon, would this association, then, give more weight to the Ascendant and/or its lord in the selection of a ruler of the nativity? Hephaestio does not address this issue, though, nor does he mention a personal daimon in any other delineations of decans.

113 Hephaestio I, 13.2 (Pingree, 39.18–19): ... ὁ δὲ τῆς γενέσεως οἰκοδεσπότης...

114 Ibid., 39.21: ... φάσεως πρὸς τὸν Ἥλιον.

115 II, 26.32 (Pingree, 198.1–3): Πρὸς τοῦτοις δὲ χρῆ σκοπεῖν τοὺς ἀφετικούς τόπους καὶ προκρίνειν τὸν ἀπηλλαγμένον καὶ ἐλεύθερον κακοποιουῦ συστάσεως.

116 I, 1.109 (Pingree, 15.24–16.3): ... καὶ κηδεμονίαν αὐτοῦ ποιήσεται ὁ οἰκείος αὐτοῦ δαίμων καὶ τύχη, ἔσται δὲ ἐπίνοσος, τεύξεται δὲ καὶ ἰατρικῶν βοηθημάτων καὶ μετὰ τὴν νεότητα εὐνοηθήσεται ἀπὸ γυναικὸς καὶ ἐσχάτης καλῆς τεύξεται.

2.8 *Rhetorius's Oikodespotēs*

Rhetorius provides several chapters on the predominator and the housemaster.¹¹⁷ He claims to be using the techniques of Valens.¹¹⁸ His method also shows the influence of Dorotheus, as he stresses that the *oikodespotēs* must aspect the Sun or Moon (he quotes Dorotheus on the importance of looking at what aspects the *aphetēs*).¹¹⁹ For the *oikodespotēs*, Rhetorius uses either the house- or bound-lord of one of the luminaries.¹²⁰ Finding the *oikodespotēs* is essential for determining lifespan. The length of life is based on the condition of the *oikodespotēs*, which gives a certain number of years (if it is in very bad condition, it gives not years, but 'months, days or hours').¹²¹

TABLE 7.1 *Summary of meanings of Oikodespotēs*

Astrological Authors on the *Oikodespotēs*

Dorotheus: The *haylāj* of the Arabic version equates to the Greek version's *aphetēs*, and Porphyry's 'predominator'. This *haylāj* must be aspected by one of its lords (house, exaltation, triplicity or bound). The bound lord of the *haylāj* is the *kadhkhudāh*, equivalent to the *oikodespotēs*.

Ptolemy: There can be more than one *oikodespotēs* (i.e. an *oikodespotēs* of length of life, of quality of soul, etc.). To find it, look at the planet's house, triplicity, exaltation and bound lords, plus the planet's phase or configuration (this would especially privilege a visible planet making an aspect, either applying or separating, or a planet in a phase of visibility). He does not mention anything here about looking first at the Sun or Moon. However, his methods for finding a predominator and *oikodespotēs* for life expectancy do use the Sun and Moon, as well as the preceding syzygy and the Ascendant.

117 CCAg VIII/1, 239–41, chapters 17, 19 and 20 (from Par. gr. 2506); see Appendix 7.A, #10 (L482), for an excerpt from these chapters and a chart delineated using Rhetorius's rules.

118 One of Rhetorius's chapters (19) is entitled 'On Nativities without a housemaster according to Valens' (CCAg VIII/1, 240). See Valens, III, 1; III, 3 and the examples in III, 5 (the examples do not have a housemaster).

119 Chapter 20, CCAg VIII/1, 241.9–10: καὶ τοῦτο λέγει Δωρόθεος ὅτι «παντὸς ἀφέτου χρῆ τὴν μαρτυρίαν βλέπειν»...

120 Ibid., Chapters 17 and 19, 239–40.

121 Ibid., 239.16: ... ἀλλὰ μῆνας ἢ ἡμέρας ἢ ὥρας.

TABLE 7.1 Summary of meanings of *Oikodespotēs* (cont.)

Astrological Authors on the *Oikodespotēs*

Valens: In III, 1: find the predominator (Sun, Moon, possibly Ascendant or Midheaven lord), and the bound-lord of this is the *oikodespotēs*, as long as it is well-placed. (This is used to determine life expectancy.) Book VII, 2 has more on an *oikodespotēs* ruling over effective or ineffective times of life.

Firmicus: Ultimately, the *oikodespotēs* is the lord of the sign following the Moon's sign. It is considered as a whole chart ruler.

Paulus and Olympiodorus: Sun, Moon, rulers of prenatal syzygy, rulers of Lots of Fortune and Daimon, and lord of Ascendant are considered for the *oikodespotēs*, if they are in the right places. From this is derived a planet with the most authority for the nativity. Again, this is used in length of life calculations.

Hephaestio: An *oikodespotēs* can be the house-ruler of a sign, but also have another dignity in the sign (i.e. by exaltation, triplicity or bound). An *oikodespotēs* of the nativity seems to follow Ptolemy's rules, also possibly using a planet in an aphetic place.

Rhetorius: The *oikodespotēs* must be the house- or bound-lord of the Sun, Moon or Hour-marker. It must be in aspect to these as well. It is used in length of life determinations.

3 Porphyry's Astrological Treatise

Although some scholars have questioned whether Porphyry is the author of the *Introduction to the Tetrabiblos*,¹²² I am reasonably confident of his authorship

122 Chiefly, it appears, Franz Boll (F. Boll, *Studien über Claudius Ptolemäus: ein Beitrag zur Geschichte der griechischen Philosophie und Astrologie* (Leipzig: B. G. Teubner, 1894), 112–18, esp. 117–18). One of Boll's arguments (117) is that if the treatise were truly Porphyry's he could not have refrained from commenting on *heimarmenē* and free will as he did in *What is Up to Us*. But the *Introduction* is an astrological text, not a philosophical text. Surely the reverse argument does not hold water, namely that the authorship of *On What is Up to Us* is in question because Porphyry does not give exact astrological techniques like those in his astrological treatise—so why would it be true when applied to the astrologi-

(except for the last chapters, 46–55, which have been shown as late additions to the text).¹²³ Certainly Porphyry lifted large portions of his text from the earlier astrologer Antiochus of Athens,¹²⁴ but this should not invalidate his authorship in general.¹²⁵ Possibly the *Introduction* was written as a teaching text which could have been revised and/or supplemented over a period of

-
- cal treatise? Another argument is that someone who claims in the *Letter to Anebo* that the tenets of astrology are 'akatalēptos' would not even dare to write an introduction to a book which claims in the beginning that knowledge through astronomy *is* graspable: 'Und wie kann derselbe, dem diese ganze Theorie ἀκατάληπτος erscheint, eine Einleitung zu einem astrologischen Werk schreiben, dessen erstes Kapitel betitelt ist: ὅτι καταληπτικὴ ἢ δι' ἀστρονομίας γινώσις?' (117) (this is the title of ch. 2, Book I of the *Tetrabiblos*). But 1) Porphyry could be playing devil's advocate in asking if astrological techniques are truly 'ungraspable'; 2) his words are paraphrased by Iamblichus for the latter's own purposes (i.e., to make Porphyry look inconsistent) in this section (15a–c = *DM* IX.3, 276.5–10; *DM* IX.4, 277.1–4; *DM* IX.5, 278.12–15); 3) it makes little sense that Porphyry would claim an astrological *oikodespotēs* if he thought it could not be found; and 4) he does claim in the Proemium of the *Introduction* (*CCAG* V/4, 190.9–10) that astrological technique can be grasped, as long as it is properly laid out. Boll's third argument (118) uses quotations from the anonymous *Commentary on the Tetrabiblos*, the *Tetrabiblos* itself, and the *Introduction* to claim essentially that Porphyry would have quoted himself more if the *Introduction* were genuinely his. How can Boll know this? I do not find these arguments compelling (and I wonder if Boll was influenced by the astrological prejudice of his day). Among current scholars, Giuseppe Bezza also does not accept Porphyry's authorship. See Bezza, 'Length of Life', 5; '... falsely attributed to Porphyry: (He gives no reason.)
- 123 D. Pingree, 'From Alexandria to Baghdād to Byzantium', 7–8. Chapters 47–52 were inserted by Demophilus, and 46 and 53–55 should also not be attributed to Porphyry, but Pingree accepts the rest of the chapters as authentic. In fact, he uses Porphyry as the author of the *Introduction to the Tetrabiblos* to help date Antiochus (as a *terminus ante quem*).
- 124 Pingree, 'Antiochus and Rhetorius', 205–08, has done the work of comparing the texts. Pingree drew on and expanded the work of Cumont, 'Antiochus d'Athènes et Porphyre', whom he cites, but he disagrees with Cumont's dates for Antiochus.
- 125 In addition to Pingree as above, n. 123, most scholars accept the work as genuine Porphyry, including Stefan Weinstock and Emilie Boer, who edited the original *CCAG* version ('... vix est quod dubitemus, quin Porphyrius philosophus ipse Introductionem in astrologiam composuerit', *CCAG* V/4, 187). Bidez, *Vie de Porphyre*, 72*, No. 70, also accepts it as genuine, and Andrew Smith in his *Fragmenta*, liii, includes it as a genuine work of the 'Scientifica et Miscellanea' and at 490 numbers it P. 64, though he does not provide the text. An early printed edition was Basle 1559. It may be the same as what the *Suda* IV, 178.30–31 (Adler) calls 'Εἰσαγωγὴν ἀστρονομουμένων ἐν βιβλίῳ τρισί' (see the note for 418T in Smith, ed., Porphyry, *Fragmenta*, 490; also the introduction of Boer and Weinstock, *CCAG* V/4, 187). Harold Tarrant kindly put selected representative passages of the *Introduction* through a statistical analysis for me, which did not dispute Porphyry's authorship, although as a more technical piece of writing it was distant in style from his purely philosophical

time.¹²⁶ Marilyn Lawrence has plausibly suggested that the *Introduction* may even have been a response to Plotinus's statements on astrology, especially those in Book 11, 3 of the *Enneads*.¹²⁷ I add that Porphyry may not only have been writing in response to Plotinus (fulfilling a debt to his teacher at long last), but also, with his extensive discussion of the *oikodespotēs* in Chapter 30, specifically rebutting Iamblichus's criticisms.¹²⁸

There is some additional, circumstantial evidence for Porphyry's authorship. He did not just lift Antiochus without commentary. Chapter 30 contains illuminating comments. Given Porphyry's interest in finding the astrological personal daimon by the technique of the *oikodespotēs*, these comments stress its significance and provide another indication that the work is his, sandwiched as they are between the words of Antiochus. Here are the parallel passages from Antiochus and Porphyry (similarities are underlined; additions in Porphyry are italicised).

Antiochus:

Λέγει δὲ ὡς οἰκοδεσπότης γενέσεως καὶ κύριος καὶ ἐπικρατήτωρ διαφέρουσιν ἄλλήλων. ἐπικρατήτορα μὲν γὰρ λέγει τῶν δύο φωστήρων ὃς μᾶλλον τῷ γενετήρι διαθέματος ἐπικρατεῖ, καὶ τινας μὲν λέγειν ὡς ἡμέρας ὁ Ἥλιος ἐπικρατεῖ, νυκτὸς δὲ ἡ Σελήνη. (*Introduction*, CCAG VIII/3, 118.9–12)

He (Antiochus) says that the House-master of the nativity, lord and predominator are different from one another. For he says that the predominator is the one of the two luminaries which predominates more over the theme's birth-hour,¹²⁹ and some say that by day the Sun predominates, but by night the Moon.

commentaries. The closest parallels were to portions of *Contra Christianorum*, the *Commentary on Ptolemy's Harmonics*, and *De antro Nympharum*.

126 Harold Tarrant suggested this to me in a personal conversation (17 Feb 2015). See also Johnson, *Religion and Identity in Porphyry*, 156, 163–64, 167–68.

127 Lawrence, 'Who Thought the Stars are Causes?', 30–31.

128 Porphyry died ca. 305 CE (Iamblichus, *On The Mysteries*, trans. Clarke/Dillon/Hershbell, Introduction, xxi). *DM* was composed between 280 and 305 (ibid., xxvii), but the odds are it appeared before Porphyry's death, especially if we accept Dillon's argument that *DM* was a youthful work (Iamblichus, *In Platonis dialogos commentariorum fragmenta*, ed. John Dillon, (Leiden: Brill, 1973), 13).

129 LSJ, s.v., says that γενετήρ = γενέτης, 'begetter, ancestor'. Though I suppose one could translate 'dominates more over the theme's begetter', i.e. taking the native as the literal cause of the creation of the chart, I think γενετή, 'hour of birth' may fit the context better here. But I am not sure of this translation.

Porphyry:

Ἔτι τίνι διαφέρουσιν ἀλλήλων οἰκοδεσπότης γενέσεως καὶ κύριος καὶ ἐπικρατήτωρ, χρὴ διεσταλκέναι. οἱ γὰρ ἀρχαῖοι πλέξαντες τὰς ὀνομασίας τὴν ἐπαγγελίαν οὐ διέκριναν. ἰδίαν γὰρ ἕκαστος ἔχει δύναμιν, ὡσπερ ναύκληρος καὶ κυβερνήτης· διδάξομεν οὖν, τίνι ἀλλήλων διαφέρουσι. τινὲς μὲν οὖν ἡμέρας τὸν Ἥλιον, νυκτὸς δὲ τὴν Σελήνην ἐπικρατεῖν τίθενται. . . . (*Introduction*, CCG V/4, 206.3–8)

Furthermore, *precise definitions are required* to differentiate house-master of the nativity, lord and predominator from one another. *For the ancients entangle the names up and do not distinguish their characteristics. For each has its own power, just like a skipper and a pilot; so we will teach how they are different from each other.* Now some hold that the Sun by day and the Moon by night predominate. . . .

I have underlined the points of agreement between the two texts, but the points of deviation (in italics) are more interesting. Note what Porphyry says when he diverges from Antiochus: '*precise definitions are required. For the ancients entangle the names up and do not distinguish their characteristics. For each has its own power, just like a skipper and a pilot; so we will teach how they are different from each other*' (my italics). What was a matter-of-fact statement in Antiochus has taken on a certain urgency in Porphyry. Porphyry stresses the difference between the three concepts, and the importance of distinguishing between them (which he is prepared to do). He even provides a poetic simile to emphasise how important the differences are, a simile with philosophical implications. The '*kubernētēs* metaphor' is well-known in philosophical circles, especially Platonic.¹³⁰ We have seen Plotinus using the metaphor of the soul as if onboard a ship and the daimon as encouraging its virtuous behaviour. Plato calls *nous* the 'pilot of the soul' (*Phaedrus* 247c7), and we have previously seen connections between the daimon and *nous* in the *Timaeus*. Other middle and

130 See the informative paper of E. Afonasin, 'The *Kybernētikē Technē* Metaphor in the Platonic Tradition' (paper presented at the 12th Annual Conference of the International Society for Neoplatonic Studies, Lisbon, Portugal, 16–21 June 2014), 2–3. Afonasin cites numerous examples of this metaphor from Plato (e.g. *Rep.* 488a, *Statesman* 272e, 296e, *Phaedrus* 247c) and later Platonic traditions (e.g. Numenius, Fr. 18; Iamblichus, *Comm. in Tim.*, Fr. 87 (Dillon, 200–01); Iamblichus, *DM* 3.26.163.10; Alexander of Aphrodisias, *De anima* 20.29; Plotinus, *Ennead* 4.3; Porphyry, *Ad Gaurum* 10.4–6).

Neo-Platonic examples show the daimon as governor of the soul,¹³¹ earlier we also saw Proclus using similar language to describe the powers of the daimon (246 and n. 48). Porphyry even uses the metaphor elsewhere, in *To Gaurus on how embryos are ensouled*, where at birth a ‘pilot’ (the [self-moving] soul) of the fetus comes into the body (the ship, built by Nature).¹³² Later (16.5.1–5) this ‘pilot’ is connected to the soul which enters the body at the right astrological moment,¹³³ a concept fleshed out in *On What is Up to Us*. This pilot, I would argue, is the personal daimon guiding the soul of the newly incarnated life. Thus I suggest that the reasons for Porphyry’s insistence in Chapter 30 on enhancing these definitions, and the specific language he uses, are precisely because of this Platonic background inciting his interest in seeing what imparts the personal daimon in the birthchart.

The rest of this chapter shows us Porphyry’s treatment of the predominator, house-master and lord, what he means by *oikodespotēs* (and if he distinguishes more than one meaning) and how these may relate to the discovery of an astrological personal daimon. The first section is clearly borrowed from the summary of Antiochus’ *Introduction*, chapter 28 (29 Cumont) (see Appendix 7.B for a full comparison between ch. 30 of Porphyry and ch. 28 of Antiochus). Here is the entire paragraph as written by Porphyry:

Furthermore, precise definitions are required to differentiate *house-master* of the nativity, *lord* and *predominator* from one another. For the ancients entangle the names up and do not distinguish their characteristics. For each has its own power, just like a skipper and a pilot; so we will teach how they are different from each other. Now some hold that the Sun by day and the Moon by night predominate, but it is set out precisely like this: for a diurnal nativity the Sun, if it is being carried up in the east, will itself take the predomination; but when the Sun is declining on the west

131 See Timotin, *Démonologie*, 248–49, 315–16.

132 *Ad Gaurum*, 10.4–11.2 (see Wilberding, *To Gaurus*, 44–45 and commentary), e.g. 10.4.1–4 (Kalbfleisch, 47.5–8): ὁ δὴ πάς χρόνος ἐν τῇ γαστρὶ εἷς τε τὴν πλάσιν καὶ τὴν πῆξιν ἀναλίσκεται, εὐκίως νεῶς κατασκευῆ εἰς ἣν αὐτίκα δὴ μάλα ὅταν ἐκτελέσας αὐτὴν ὁ ναυπηγὸς εἰς τὴν θάλασσαν καθελκύσῃ, ὁ κυβερνήτης εἰσοικίζεται. ‘Indeed, the entire time in the belly is spent on forming and solidifying, like in the building of a ship, where at the very moment when the ship-builder has completed the ship and launches it into the sea, the ship’s pilot is settled in it (Trans. Wilberding, 44, modified slightly. I have translated κυβερνήτης as ‘pilot’ and εἰσοικίζεται as ‘is settled in’).

133 See Wilberding, *To Gaurus*, 53 and n. 220 (he follows Festugière’s reading of <ατὰ καιρὸν> ψυχὴ τῷ τεχθέντι γενομένη: Festugière, *La révélation d’Hermès Trismégiste*, vol. 3, *Les doctrines de l’âme*, 297, n. 1).

[side of the chart], if the Moon is in the east, that one [*the Moon*] will take it, even if she is post-ascending the Hour-marker [*i.e. in the second place*], because she is going up on the east [side of the chart]. But if both [the luminaries] are declining on the west [side], the Hour-marker will hold the predomination. For a nocturnal nativity, if the Moon is being carried up on the east [side], she herself will take the predomination. But if she is declining on the west [side of the chart], but the Sun, though still under the earth, is post-ascending the Hour-marker, that one will predominate.¹³⁴

The Antiochus portion breaks off at this point, but it is not unreasonable to assume Porphyry would have continued to follow Antiochus while adding his own commentaries. (See Appendix 7.C for Porphyry's whole chapter.) This first part explains how to determine the 'predominator', the *epikratētōr* of the chart: either the Sun or the Moon are preferred, but the Ascendant can also become the predominator if the luminaries are not well-positioned. 'For generally the luminary that is more on a centrepin, and more in the east and of the sect determines the predominator. If both [the luminaries] are declining, then the Hour-marker will obtain the predomination.'¹³⁵ The reason that Porphyry (following Antiochus) is interested in finding the predominator is because the *oikodespotēs* is determined from it: it is the lord (i.e. house-ruler) of the sign in which the predominator is found, and a co-house-master is the planet that rules the bounds of that place (this is approximately meaning #3).

Porphyry continues, at length, on ways to find the overall 'lord' (*kurios*) of the chart, and gives the opinions of others on to how to find it. He says the process is intricate and difficult, 'For the search for this is long and perhaps more difficult than all others.'¹³⁶ He looks at a number of 'rulers'—he calls them *oikodespotai*—who can be considered for the job of overall chart ruler. They are lords of particular places in the chart: the Midheaven, the Ascendant, a planet in the first place, etc. (207.7–23). After giving the candidates, he finally says that to choose the overall lord of the chart (to be known as the 'lord of the geniture' in medieval and Renaissance astrology), find 'the one placed most sympathetically in the nativity, that is, the one situated better [*in a good place*],

134 The portions about determining the ability of the Sun or Moon, based on their position in the chart (eastern or western, rising or setting), to be the leading chart authority have a certain similarity to a passage in Serapion (CCAG VIII/4, 228.12–15).

135 Porphyry, *Introduction to the Tetrabiblos*, CCAG V/4, 206.21–24: τὸ γὰρ ἔλον ὁ ἐπικεντρότερος τῶν φῶτων καὶ ὁ μᾶλλον ἐν τῷ ἀπηλιώτῃ καὶ τῆς αἰρέσεως κρίνεται ἐπικρατήτωρ. ἐὰν δὲ ἀμόφτεροι ἀποκλίνωσιν, ἀποίσεται τὴν ἐπικράτησιν ὁ ὠροσκόπος τότε. . . .

136 CCAG V/4, 208.1–2: πολλὴ γὰρ ἡ περὶ τούτου ζήτησις καὶ σχεδὸν ἀπάντων δυσκολωτέρα.

more in a phase of visibility, or more on its own places and having the most power in relation to the configuration of the nativity and those co-witnessing it.¹³⁷ (This is approximately meaning #4). This process makes clear that Porphyry, contrary to what Iamblichus has said about him flitting between one daimon (i.e. *oikodespotēs*)¹³⁸ for this and another daimon for that (*DM* IX.7, 281.5–13), is ultimately interested in a single lord of the nativity (thus representing the astrological personal daimon).

At each step Porphyry looks for the planet in the best condition in the chart, one most able to give benefits. Each succeeding ruler builds on the strength of the one before it. Each time a planet is seen to have difficulty (cadent, setting in the west, in a phase of invisibility, out of sect with the chart), it is discarded in favour of a stronger planet. The finding of these three rulers helps coordinate the selection of an overall ruler of the chart. One planet may be both house-master and lord. In that case, Porphyry says, it ‘will [then] rule over a great outcome.’¹³⁹ (One planet could also be both predominator and house-master, if one takes the sign ruler of the predominator as the house-master.¹⁴⁰ This seems to be Porphyry’s preference, with the bound-lord being a co-housemaster.)¹⁴¹

Porphyry’s methods are similar to those of the other astrologers previously cited, except for Firmicus.¹⁴² All except Firmicus use the positions of the Sun, Moon or Ascendant in some way (Firmicus indirectly uses the Moon position). The concept of an *oikodespotēs* determined from a predominator is covered by Dorotheus and Valens. Some of the procedures he describes are similar to those attributed to Dorotheus in Hephæstio II, 26 (though they are each finding different kinds of rulers). Porphyry relies on ‘good’ or ‘operative’ places for his determinations (not unlike Ptolemy’s aphetic places). Paulus and Olympiodorus ultimately want to find a planet with the ‘most authority’, similar to Porphyry’s *kurios*, lord (which is clearly the forerunner of the Medieval *almuten thematis*). While the interests of the other astrologers are mostly in determining length of life, Porphyry does not mention length of life in this

137 Ibid., 207.23–27: ἐκ δὲ τούτων πάντων τὸν συμπαθέστατα πρὸς τὴν γένεσιν κείμενον ἀποφαίνονται κύριον, τουτέστι τὸν ἐπικείμενον πρότερον, τὸν ἀνατολικώτερον ἢ τὸν μᾶλλον ἐπ’ οἰκείων τόπων καὶ τὴν πλείστην δύναμιν πρὸς τὸ σχῆμα τῆς γενέσεως ἔχοντα τοὺς τε συμμαρτυροῦντας αὐτῷ.

138 See 250 and n. 59.

139 Ibid., 208.4–5: . . . ἄρξει μεγάλου ἀποτελέσματος.

140 E.g., the Sun in Leo as predominator in a diurnal chart would also be the house-master, if the house-master is the sign ruler.

141 Ibid., 207.1–3: ὁ μὲν γὰρ κύριος τοῦ ζωδίου, ἐν ᾧ ἐστὶν ὁ ἐπικρατήτωρ, οἰκοδεσπότης ἔσται, ὁ δὲ τῶν ὀρίων συνοικοδεσπότης.

142 His method clearly is anomalous.

chapter. In fact, his interest seems to be, ultimately, in finding an ‘authentic’ or ‘authoritative’ (αὐθεντικόν) planet which rules over the whole life (‘rule over those who have been born’ (τῶν γεννωμένων κυριεύειν),¹⁴³ whatever its length.

What, for Porphyry, is the ultimate relationship among the predominant, house-master and lord? All three are involved in finding an overall ruler for the chart, a planet that connects all the important parts of the chart together: the luminaries, the Ascendant, the aspects between these places and planets, the important places of the chart like the Ascendant, Midheaven, eleventh place, the Lot of Fortune; the planets in phases of visibility. The planet with strong position, good phase, connection with luminaries and relationships with important places in the chart becomes able to coordinate the whole work and purpose of the chart. Here, in astrological language, is the work of the personal daimon made manifest. The planet which represents the personal daimon becomes a way for the astrologer to do a kind of astrological theurgy, either for himself or for his client: a ritual involving stars, mathematics, harmony (*sympatheia*) and light. He is not just finding a strong and well-endowed planet, but a planet which becomes the astrological analogue of the personal daimon. Again, that planet cannot be one in a weak position—this is not a technique which comes up with a feeble daimon, but one which can spur the holder of such a chart on to his/her highest potential.

How might Porphyry see this procedure in relation to theurgy? In discussing the ‘higher’ and ‘lower’ theurgy of Iamblichus,¹⁴⁴ Andrew Smith suggests that ‘lower’ theurgy has to do with *sympatheia* and the material world, which includes daimons.¹⁴⁵ However some scholars, e.g. Addey and Shaw, prefer not to divide theurgy into ‘lower’ (suggesting ‘inferior’) and ‘higher’ levels, but consider theurgical practice as more integrative and cumulative in attaining unity with the divine.¹⁴⁶ Though Iamblichus also distinguishes, as we saw, between the ‘theurgic’ and ‘technical’ way to find the personal daimon (DM IX.1, 273.2–9), both methods would be useful in theurgic practice; one would not necessarily be inferior to the other. In the *Cave of the Nymphs*, Porphyry mentions propitiating one’s personal daimon as a good thing to do (using the example

143 Ibid., 207.16–18 (giving context): τοῦτον γὰρ τῆς κοσμικῆς ἐπισημασίας τότε γινόμενον αὐθεντικὸν ὁμολογουμένως καὶ τῶν γεννωμένων κυριεύειν. . . .

144 A. Smith, *Porphyry’s Place in the Neoplatonic Tradition: A Study in Post-Plotinian Neoplatonism* (The Hague: Martinus Nijhoff, 1974), 90–99.

145 Ibid., 90.

146 Addey, *Divination and Theurgy*, 39–40; G. Shaw, ‘Theurgy: Rituals of Unification in the Neoplatonism of Iamblichus’, *Traditio* 41 (1985): 1–28, esp. 7–8.

of Odysseus): ‘Hence his sitting under the olive tree befits him, since he is the god’s suppliant and appeases the natal daimon under the olive branch.’¹⁴⁷

Even if Porphyry considered theurgic ritual in general to ‘purify the lower soul’,¹⁴⁸ and regarded discovering the personal daimon through astrology as a theurgic ritual, this discovery would still be an important way to increase knowledge which would lead to becoming more virtuous. Knowing about one’s personal daimon in whatever ways are available, including astrological, could only improve one’s ability to understand the plan of the life the soul has chosen, and aid in the achievement of virtue. There may even be, in finding the astrological daimon, a way to free oneself from part of fate by propitiating the right gods in the right way. In the *Letter to Anebo*, Porphyry connects *heimarmenē* with the stars, but these stars represent gods who can deliver one from it:

And most of them [the Egyptians] even made what is up to us dependent on the motion of the stars, binding them fast, I do not know how, by the indissoluble bonds of Necessity, which they call Fate, and making all things dependent on these gods whom, as *the only deliverers from Fate*, they worship with temples, and statues, and the like.¹⁴⁹ (my italics)

More importantly, the personal daimon has a role to play in the release from *heimarmenē*: ‘he is surely happy (*eudaimōn*) who, learning the celestial configuration of his own birth, and hence recognising his personal daimon, is enabled to neutralise by sacrifices the power of fate.’¹⁵⁰ For Porphyry, neutralising

147 Porphyry, *De antro nympharum*, Nauck, 35.8–11; Seminar Classics 609, 32.26–27: ἔνθεν αὐτῷ καὶ ἡ ὑπὸ τὴν ἐλαίαν καθέδρα οἰκεία ὡς ἰκέτη τοῦ θεοῦ καὶ ὑπὸ τὴν ἰκετηρίαν ἀπομειλισσομένῳ τὸν γενέθλιον δαίμονα. Translation (slightly modified) of Seminar Classics 609, eds, *The Cave of the Nymphs*, 33.

148 Shaw, ‘Theurgy: Rituals of Unification’, 2 (citing Porphyry, *De regressu animae*, 27.21–28.15).

149 *Letter to Anebo*, 2.13a (Sodano, 25.3–7): «Ὡν οἱ πλείους καὶ τὸ ἐφ’ ἡμῖν ἐκ τῆς τῶν ἀστέρων ἀνήψαν κινήσεως, οὐκ οἶδ’ ὅπως δεσμοῖς ἀλύτοις Ἀνάγκης, ἣν εἰμαρμένην λέγουσιν, πάντα καταδήσαντες καὶ πάντα τούτοις ἀνάψαντες τοῖς θεοῖς, οὓς ὡς λυτήρας τῆς εἰμαρμένης μόνους ἐν τε ἱεροῖς καὶ ξοάνοις καὶ τοῖς ἄλλοις θεραπεύουσιν.» See also the fragment (no. 5) of Chaeremon which incorporates this, Chaeremon of Alexandria, *Chaeremon: Egyptian Priest and Stoic Philosopher. The fragments collected and translated with explanatory notes*, ed. P. W. van der Horst (Leiden: E. J. Brill, 1987), 14–15.

150 *Letter to Anebo*, 2.14d (Sodano, 26.15–16 = *DM* IX.3, 275.1–3 [Des Places], trans. Clarke/Dillon/Hershbelle, modified): ‘... δὴ ὡς οὗτος ἦν ἄρα εὐδαίμων ὅστις μαθὼν τὸ σχῆμα τῆς αὐτοῦ γενέσεως τὰ εἰμαρμένα ἐκθύσαιτο γινὼς τὸν ἑαυτοῦ δαίμονα. Broze and Van Liefferinge, ‘Le démon personnel’, 75, misinterprets this passage as meaning that once an astrologer

the power of fate would not have been achieved through actual sacrifice, but through the wisdom and virtue obtained from knowing the personal daimon via astrology.

By knowing his own astrological configurations, then, Porphyry thinks he will be better able to free himself from the material bonds of *heimarmenē*, and to construct his theurgic rituals accordingly. In this way Porphyry, by taking on the long and difficult task of finding the true strongest and best planet in the chart, is actually beginning his own theurgy with astrology; for him, this task becomes a religious endeavour every bit as sacred and elevating as the theurgical rites Iamblichus finds so inspiring.

discovers his daimon in the chart, he 'can influence him and be master of his fate' ('... peut influer sur lui et être maître de son destin!'). They go too far in ascribing an urge for power over the daimon to an astrologer. The point is to work *with* the daimon, not control it, to become free of *heimarmenē*; at any rate, this is clearly Porphyry's intention.

PART 3

Lots and the Daimon



Allotment, The Daimon and Astrology

There was a daimon in me, and in the end its presence proved decisive.

CARL JUNG¹

Lots are a major technique in Hellenistic astrology, and some of them involve the daimon either directly or tangentially. This chapter will first explore the use of lots in Hellenistic culture, along with their relationship to the daimon, and continue by investigating lots in astrological technique. This chapter introduces the general concept of lots; the following two chapters will concentrate on the specific lots of Fortune, Daimon, Eros and Necessity. What does the cultural understanding of lots tell us about the way they are used in astrology? Can the theory of the astrological lots give us insight into the cultural significance of lots? Let us keep these questions in mind as we continue our exploration.

The earliest clearly datable writing on lots in Hellenistic astrology is Manilius, *Astronomica* (3.75–202) (the poem can be dated to the time of Augustus and his successor Tiberius).² The earliest evidence of employing lots in practice appears to be 1) a chart of 43 BCE discussed by Balbillus (L-42 in *GH*)³ and, possibly, 2) a chart in the Arabic translation of Dorotheus that mentions ‘Fortune’;⁴ dated by David Pingree to 13 CE. There is lot doctrine in Nechepso and Petosiris, of uncertain date, but probably second to first century BCE. This suggests that the astrological lot had, in part at least, a Hellenistic-Egyptian origin. Dorotheus (first century CE), mentions not only the Lot of Fortune but the Lots of Daimon, marriage, father, mother, brothers and others. In the *Liber Hermetis* and Rhetorius, lot interpretation is given some prominence;⁵ though these texts are late, they are thought to have drawn on Hermetic material

* With many thanks to †Josèphe-Henriette Abry for her helpful comments on this chapter.

1 C. G. Jung, *Memories, Dreams, Reflections*, trans. Richard and Clara Winston (New York: Vintage Books, 1961, repr. 1989), 356.

2 See Goold’s Introduction to the *Astronomica* (Loeb), xii.

3 This chart appears to calculate the Midheaven position from the Lot of Fortune, though Fortune’s position is not listed.

4 But probably does not mean the Lot of Fortune; in *Carmen Astrologicum*, 1, 24 (Pingree, 185). See discussion in Chapter 2, 2.4, 63–64; Chapter 9, section 4, 311 and n. 31.

5 *Liber Hermetis*, ch. 16, seventh consideration (Feraboli, 58–62); Rhetorius, ‘Investigation of Chart Factors’, fifth consideration (see Appendix 8.C).

which may be as early as the second century BCE. Lots are a continuing theme in much Hellenistic astrological writing.

1 Lots in Hellenistic Culture

In using lots, astrology is drawing on a well-developed tradition in Greek culture. The Greek word for a lot, κλήρος, probably derives from the shard of stone or wood used to cast lots.⁶ It seems to be related to the verb κλάω, 'break'.⁷ Its original meaning describes the lot which is cast to give an allotment; in the beginning this was property. Later a κλήρος itself was a piece of property, or a received inheritance. But it was also part of a divinatory practice in that the casting of lots, and the decisions gained thereby, were seen as a way to know the will of the gods. The decision of the lot was seen as binding. In fact (though paradoxically), even the gods cast lots to make decisions: the allotments of the portions of the world to Zeus, Poseidon and Hades were made by lot.⁸ In Babylonian mythology, Anu, Ea (Enki) and Enlil also were given their kingdoms of heaven, water and earth by lot.⁹

As well as being a divinatory tool on its own, sortition was used in traditional oracles. Delphi had a lot oracle,¹⁰ and Cicero mentions a lot oracle at Dodona, which the Spartans consulted before the battle of Leuctra.¹¹

6 See 'κλήρος' in R. S. P. Beekes, 'Etymological Dictionary of Greek' (BrillOnline *Dictionaries*), online at <http://dictionaries.brillonline.com/greek> (accessed 29 April 2015). I thank Katelyn Chin for accessing this entry for me. Chantraine, Tome II, 542–43 and Frisk, Bd. 1, 872–73, say the same. Interestingly, κλήρος is also said to be related to the Celtic word clār, which means a board or a piece of wood (Chantraine, II, 543; Frisk, I, 873).

7 Bezza, *AM*, vol. 2, 963 also gives an etymology of κλήρος. His entire chapter on lots is informative, and has served as a source for my investigation.

8 See *Iliad*, 15.187–93. (Bezza, *AM*, vol. 2, 963, gives this allusion.) In *Iliad*, 7.171–199, lots are cast to decide who fights Hector.

9 'They [the Annunaki] took the box . . . / Cast the lots; the gods made the division. / Anu went up to the sky, / [And Ellil (?)] took the earth for his people (?). / The bolt which bars the sea / Was assigned to far-sighted Enki.' Trans. Dalley, *Myths from Mesopotamia*, 9, 'Atrahasis' (The Flood), Tablet 1, 11–16. The similarity between the passage in the *Iliad* and this myth is also mentioned by W. Burkert, 'Signs, Commands, and Knowledge: Ancient Divination between Enigma and Epiphany', in *Mantikê. Studies in Ancient Divination*, ed. Sarah Iles Johnston and Peter Struck (Leiden: Brill, 2005), 29–49, here 37. Burkert stresses the random nature of lot-casting as a sign of its complete objectivity, and therefore rationality; but see below, 281 and n. 16, for Plato's take on this.

10 Burkert, *Greek Religion*, 116.

11 Cicero, *De divinatione*, 1.34.75–76.

The political use of lots in Athenian civil society was widespread.¹² Aristotle tells us, in *The Athenian Constitution*, that many judicial practices were made by lot,¹³ as well as the selection of Greek archons and many officials.¹⁴ Even in modern Greece land has sometimes been apportioned by lot.¹⁵ However the casting of lots, while often seen as the fairest way to choose something, was not universally employed. Lots were not used for occupations requiring specific skills; e.g. generals were not chosen by lot. Plato (*Laws* 757b–758a) points out this drawback: choosing by lot, though allowing all an equal chance, does not always obtain the best person. Therefore, he says, it is important to pray to Zeus and to Good Fortune to have the lot fall out so that the best is chosen (Plato calls this ‘proportional’ justice).¹⁶ Here then, chance is linked with divinity in finding the outcome by lot. This linkage may have something to do with the antiquity of the Lot of Fortune and why it is the most prevalent lot in astrology.

12 For a survey of Athenian practices, see R. G. Mulgan, ‘Lot as a Democratic Device of Selection’, *The Review of Politics* 46, no. 4 (1984): 539–60.

13 Aristotle, *The Athenian Constitution*, 58–59.

14 *Ibid.*, 8.1–2, 22.5, 26.2, 55.

15 See H. L. Levy, ‘Property Distribution by Lot in Present-Day Greece’, *TAPhA* 87 (1956): 42–46. Lotteries can assign students to charter schools in the United States today.

16 Plato states (*Laws*): [757b] ‘... there are two kinds of equality [*arithmetical and proportional*] which, though identical in name, are often almost opposites in their practical results. The one ... employing the lot to give even results in the distributions; but the truest and best form of equality is ... the judgement of Zeus, and ... [757c] it produces all things good; for it dispenses more to the greater and less to the smaller, giving due measure to each according to nature; ... it assigns in proportion [*κατὰ λόγον*] what is fitting to each. ... [757d] But there are times at which every state is compelled to use the words, “just”, “equal”, in a secondary sense, in the hope of escaping ... from factions. [757e] ... this is the reason why it is necessary to use the equality of the lot, in order to avoid the discontent of the people; and so we invoke God and good fortune (*θεὸν καὶ ἀγαθὴν τύχην*) in our prayers, and beg that they themselves will direct the lot with a view to supreme justice. ... although we are compelled to use [758a] both equalities, we should use that into which the element of chance enters as seldom as possible.’ Trans. R. G. Bury (757b–757c), Plato, *Laws*, (Cambridge, MA: Harvard University Press, 1926, repr. 1967); and B. Jowett (757d–758a), Plato, *Dialogues of Plato*, trans. Benjamin Jowett, vol. 5: *Laws*, Index (Oxford: Clarendon Press, 1892).

Thus in casting a lot, which is only equitable but not necessarily just, one must pray that Zeus and Good Fortune will give ‘proportional’ justice. Bezza, *AM*, vol. 2, 963, commenting on this passage, says ‘La sorte è un dio, “è il giudizio di Zeus.”’. I am not sure Plato goes that far. Rather, I think he means not that the lot itself is a god, but that *proportional judgement* is given by God (Zeus). Plato realises the indiscriminate equality of the lot can sometimes bring the wrong choice, so he invokes ‘God and good fortune’ to amend this lack of discrimination.

The Greeks were not the only society to use lots. Casting of lots was employed in Jewish culture of this same time-frame,¹⁷ and there are many other examples of the use of sortition in Roman and other cultures of the Republic, Empire and late Empire.¹⁸

1.1 *The Daimon and the Lot*

One of the best-known relationships between the daimon and lots in Hellenistic culture is exemplified in Plato's Myth of Er (*Republic* x). It provides an important backdrop for astrological lots, so is worth quoting extensively:

[617d–e] When Er and the souls arrived, their duty was to go at once to Lachesis; but first of all there came a prophet (*prophētēs*) who arranged them in order; then he took from the knees of Lachesis lots (*klēroi*) and examples (*paradeigmata*) of lives, and having mounted a high pulpit, spoke as follows: 'Hear the word of Lachesis, the maiden daughter of Necessity. Mortal souls, behold a new cycle of life and mortality. Your daimon will not be allotted (*lanchanō*) to you, but you will choose your daimon; and let him who draws the first lot have the first choice, and the life which he chooses shall be his of necessity. Virtue has no master, and as a man honours or dishonours her he will have more or less of her; the responsibility is with the chooser—God is not responsible.' So saying, the prophet scattered lots indifferently among them all, and each of them took up the lot which fell near him. . . . [618a] Next, the prophet placed on the

17 See I. Czachesz, "'As God Counsellor Socrates:" Commission Narratives in Cognitive Perspective', in *Reflecting Diversity: Historical and Thematic Perspectives in the Jewish and Christian Tradition*, ed. Péter Losonczi and Géza Xeravits (Berlin: LIT Verlag, 2007), here 18–20. Also online (with different pagination) at http://religionandcognition.com/publications/czachesz_commission.pdf (accessed 24 April 2015).

18 See, e.g., the articles of F. Graf, W. E. Klingshirn and C. Grottanelli in S. I. Johnston and P. Struck, eds., *Mantiké. Studies in Ancient Divination*, vol. 155, Religions in the Graeco-Roman World (Leiden: Brill, 2005). See also N. Rosenstein, 'Sorting out the Lot in Republican Rome', *AJPh* 116, no. 1 (1995): 43–75. In Egypt, the 'ticket oracle' is a relative of lot-casting, in which the petitioner would submit a positive or negative answer to a question ('I will marry x; I will not marry x'), and the god would send back one of the answers. See, e.g. K.-T. Zauzich, 'Die demotischen Orakelfragen—eine Zwischenbilanz', in *A Miscellany of Demotic Texts and Studies (The Carlsberg Papyri 3)*, vol. 22, CNI Publications, ed. P. J. Frandsen and Kim Ryholt (Copenhagen: Museum Tusulanum Press, 2000). A recent, and extensive, discussion of ticket oracles is in F. Naether, *Die Sortes Astrampsychi. Problemlösungsstrategien durch Orakel im römischen Ägypten* (Tübingen: Mohr Siebeck, 2010), 359–406.

ground in front of them the sample lives, of which there were far more than there were souls in the crowd. . . . [619b] And when he had spoken, he who had the first choice came forward and straightaway [*euthus*] chose the greatest tyranny. . . . [619c] . . . instead of throwing the blame of his misfortune on himself, he accused chance and the daimons and everything rather than himself. . . . [619d] . . . And owing to this [inexperience of theirs], and also because of the chance of the lot, many of the souls exchanged a good destiny for an evil or an evil for a good. [620d–e; 621a] Now when all the souls had chosen their lives, they approached Lachesis in the order the lottery had assigned them, and she sent with them the daimon whom they had chosen, to be the guardian of their lives and the fulfiller of the choice: this daimon led the souls first to Clotho, and drew them within the revolution of the spindle impelled by her hand, thus ratifying the destiny (*moira*) of each; and then, when they were fastened to this, carried them to Atropos, who spun the threads and made them irreversible, whence without turning round they passed beneath the throne of Necessity. . . .¹⁹

This passage shows the important connection between the daimon and fate, the ideas of choice and allotment strongly connected with the daimon, and lots

19 Plato, *Republic* 617d–e, 618a, 620d–e, 621a (Burnet, vol. 4); slightly modified from the Benjamin Jowett translation (vol. 3): [617d] σφᾶς οὖν, ἐπειδὴ ἀφικέσθαι, εὐθὺς δεῖν ἰέναι πρὸς τὴν Λάχῃσιν. προφήτην οὖν τινα σφᾶς πρῶτον μὲν ἐν τάξει διαστήσῃ, ἔπειτα λαβόντα ἐκ τῶν τῆς Λαχέσεως γονάτων κλήρους τε καὶ βίων παραδείγματα, ἀναβάντα ἐπὶ τὴν βῆμα ὑψηλὸν εἰπεῖν—“Ἀνάγκης θυγατρὸς κόρης Λαχέσεως λόγος. Ψυχαὶ ἐφήμεροι, ἀρχὴ ἄλλης περιόδου θνητοῦ γένους θανατηφόρου. [e] οὐχ ὑμᾶς δαίμων λήξεται, ἀλλ’ ὑμεῖς δαίμονα αἰρήσεσθε. πρῶτος δ’ ὁ λαχὼν πρῶτος αἰρείσθω βίον ᾧ συνέσται ἐξ ἀνάγκης. ἀρετὴ δὲ ἀδέσποτος, ἦν τιμῶν καὶ ἀτιμάζων πλέον καὶ ἔλαττον αὐτῆς ἕκαστος ἔξει. αἰτία ἐλομένου· θεὸς ἀνάτιος.” Ταῦτα εἰπόντα ῥίψαι ἐπὶ πάντας τοὺς κλήρους, τὸν δὲ παρ’ αὐτὸν πεσόντα ἕκαστον ἀναιρεῖσθαι. . . . [618a] μετὰ δὲ τοῦτο αὐθις τὰ τῶν βίων παραδείγματα εἰς τὸ πρόσθεν σφῶν θείναι ἐπὶ τὴν γῆν, πολὺ πλείω τῶν παρόντων. . . . [619b] Εἰπόντος δὲ ταῦτα τὸν πρῶτον λαχόντα ἔφη εὐθὺς ἐπιόντα τὴν μεγίστην τυραννίδα ἐλέσθαι. . . . [619c] . . . οὐ γὰρ ἑαυτὸν αἰτιάσθαι τῶν κακῶν, ἀλλὰ τύχην τε καὶ δαίμονα καὶ πάντα μᾶλλον ἀνθ’ ἑαυτοῦ. . . . [619d] . . . διὸ δὴ καὶ μεταβολὴν τῶν κακῶν καὶ τῶν ἀγαθῶν ταῖς πολλαῖς τῶν ψυχῶν γίγνεσθαι καὶ διὰ τὴν τοῦ κλήρου τύχην. . . . [620d] Ἐπειδὴ δ’ οὖν πάσας τὰς ψυχὰς τοὺς βίους ἤρησθαι, ὥσπερ ἔλαχον ἐν τάξει προσιέναι πρὸς τὴν Λάχῃσιν· ἐκείνην δ’ ἕκαστῶ ἐν εἴλετο δαίμονα, τοῦτον φύλακα συμ- [e] πέμπειν τοῦ βίου καὶ ἀποπληρωτὴν τῶν αἰρεθέντων. ὃν πρῶτον μὲν ἄγειν αὐτὴν πρὸς τὴν Κλωθῶ ὑπὸ τὴν ἐκείνης χεῖρά τε καὶ ἐπιστροφὴν τῆς τοῦ ἀτράκτου δίνης, κυροῦντα ἦν λαχὼν εἴλετο μοῖραν· ταύτης δ’ ἐφαψάμενον αὐθις ἐπὶ τὴν τῆς Ἀτρόπου ἄγειν νῆσιν, ἀμετάστροφα τὰ ἐπικλωσθέντα ποιοῦντα· ἐντεῦθεν δὲ δὴ ἀμεταστρεπτὶ ὑπὸ τὸν τῆς [621a] Ἀνάγκης ἰέναι θρόνον. . . .

as the medium of allotment. In addition, the element of chance (*tuchē*) plays an important role in this story. Let us go over the main points of the quotation.

- 1) A 'prophet' is in charge of the whole process of allotment and choice. At an oracle, prophets interpret the words of the *mantis* (diviner). As such, they are associated both with the act of divination and, implicitly, with prediction. The prophet here is the representative of the divine.
- 2) The prophet takes the lots and examples of lives from the knees of Lachesis. Here Plato uses two words to express allotment: the *κλήροι*, the literal, physical lots, and Lachesis, one of the Moirai, whose name comes from the verb *λαγχάνω*, which means 'allot as one's portion', thus connecting with *μοῖρα*, a portion and a destiny. Plato brings our attention to the idea of allotment linked to human life, which is controlled by the divine and administered by those who interpret for the divine ('prophet' meaning to 'speak for' the god).
- 3) The prophet tells the souls to 'hear the word of Lachesis'. As the 'daughter of Necessity', of that which is compelled, and over which there is no choice, she is the apportioner to whom they must listen.
- 4) But Lachesis paradoxically allows the souls some choice. The souls pick the life they want, and there are more lives available than there are souls, so that all have the opportunity to pick a good one, even if they are among the last to choose. They choose their own daimon, who is the guide for the life chosen. However, within the choice there is also compulsion, or necessity: the souls must choose in the order the lots fall, and there are only enough lots for each soul. Necessity, which controls the spindle and whorls representing the physical world, also comes when the souls must enter the material world of generation after they have chosen their lives.
- 5) 'Virtue has no master.' Whether each soul values virtue or not is up to her. The souls decide whether they want to choose a virtuous life or not, and their choice is the first demonstration of virtue (or lack thereof). The daimon does not interfere with that decision; it merely fulfils their choice. Here is perhaps an inkling of a 'good' or a 'bad' daimon, who fulfils either a 'good' or 'bad' life. But the daimon is only following the soul's choice: it is not *inherently* good or bad. Choosing to be virtuous, then, is the way in which we can exercise free will. Choosing virtue follows directly on choosing a daimon; by doing this Plato may be linking the two choices together, virtue being the corollary to our choice of a daimon. Both are examples of our free will.
- 6) 'God is not responsible': here the split between *theos* and *daimōn* is displayed, perhaps even the idea of an impersonal god who is above the fray

of human existence (this is where the daimon comes in). Fundamentally the soul is responsible for the choice she makes, though once that choice has been made, it is not God who fulfils it, but the daimon. (The daimons are both 'ministers' and those who 'administer'.) Nevertheless, the daimon only enforces the soul's choice of life and, like God, is not responsible for it.

- 7) We cannot ignore the workings of chance in all this. It is the chance of where the lot falls that brings about what soul picks it up. The prophet 'scatters the lots indifferently'; this random scattering,²⁰ however, leads to a certain order. (In astrology, we can compare this with the moment when the human happens to be born. The astrological lots pertinent to this discussion all project from the Ascendant, which correlates time of birth to the zodiac; thus this moment creates means for the apportionment which the lot gives. In a way, the astrological lots which use the Ascendant in astrology show the fulfilment of the order arising out of this chance event.)
- 8) The daimon, the soul's personal companion, leads the souls to fate, to the Moirai who weave, measure and cut the cloth of the life selected. The chosen daimon thus cooperates in the process of allotment.

Porphyry's exegesis of this passage in *On What is Up to Us* tries to reconcile 'what is up to us' with this allotment of lives in the Myth of Er.²¹ Furthermore, he correlates the souls' choosing of their lives, and the moment of incarnation, with the hour-marker (Ascendant) and arrangement of planets in the astrological chart. Porphyry's description shows that he knows the Egyptian doctrine of decans as life predictors; he guesses that Plato too might have known of such doctrine.²² While there is no proof that Plato knew of this, Porphyry's essay

20 This same kind of scattering occurs in geomancy; see T. Charmasson, *Recherches sur une technique divinatoire: la géomancie dans l'Occident médiéval* (Geneva/Paris: Librairie Droz/Librairie H. Champion, 1980), 21.

21 Porphyry, Περὶ τοῦ ἐφ' ἡμῶν (Wachsmuth, II, 163–73, 8.39–42 = Smith, 295–308, 268F–271F). For the astrological part, see esp. (Wachsmuth) 169–72. For commentary see Festugière in *Proclus, Commentaire sur la République*, vol. III, 349–57; Amand, *Fatalisme et liberté*, 163–66. Amand borrowed heavily in his analysis from Bouché-Leclercq, *AG*, 601–02. See also Wilberding's translation and excellent commentary in *Porphyry: To Gaurus on How Embryos are Ensouled and On What is in Our Power*, 123–53. (See also Chapter 7, 1.1, n. 26; section 2 ['The Astrological Personal Daimon'], 255 and n. 79.)

22 See Porphyry, Περὶ τοῦ ἐφ' ἡμῶν (Wachsmuth, II, 169.21–170.6, 8.42 = Smith, 303.38–304.48, 271F). For discussion of part of this passage, text and translation see Chapter 6, 2.1 and esp. n. 67. *Timaeus* 41d–e describes the soul's assignment to an individual star, and a destiny.

demonstrates his own interest in applying the Myth of Er's themes to astrological doctrine. *CH XVI.15* also has certain similarities with Plato's myth, although it is more astrologically inclined (see Chapter Six, 2.1). *Asclepius* 35, as well, seems to describe something akin to what Porphyry says about each changing moment on the horizon being equated with a different form within a common class of forms. Proclus, in his commentary on Plato's *Republic*, even considers the allotments of daimon and fortune in the Myth of Er to be correlated to the astrological lots of Fortune and Daimon: 'One particular cause determines [the daimon and fortune]: the Sun and Moon, respectively, because the Lots of Daimon and Fortune are found from these gods in our nativities, which is clear to those trained in astrology.'²³

While it would be difficult to argue that Plato makes a specific correlation between the lots in the Myth of Er and the astrological lots, this section of *Republic* certainly shows astrological knowledge and a linkage between the planets and destiny.²⁴ Porphyry and the Hermetic material build the astrological connection, and Proclus does specifically link astrological lots to it. The cultural connotation of a 'lot', created in part from stories like the Myth of Er, will play in the background of the employment of lots in astrology, and even be reinforced by astrology's use of the same word, κλήρος, for a lot. This conception of destiny does not obviate the influence of Egyptian/Mesopotamian conceptions of fate on astrology, but acts as a counterpoise to them. The strength of both conceptions within astrology shows in the diversity of the ways fate plays out in the practice of Hellenistic astrology.

2 Lot Doctrine in Astrology

My focus in this section will be particularly on the astrological lots' relationship to divinatory aspects of astrology, and the technique of lots as a way of enhancing those aspects. There is evidence of this relationship especially in Manilius and his places from the Lot of Fortune. Since the lot is created in a way that is personal and unique to each chart, it becomes a special indicator of personal outcomes in a life. The lot as interpreted by Vettius Valens has a role to play in the determination of happiness, while Paulus and Olympiodorus

23 Proclus, *Commentary on Plato's Republic* (Kroll, II, 299.25–28): ἀφορίζει δὲ ὡς ἐν αἴτιον τὸν μὲν ὁ ἥλιος, τὴν δὲ ἡ Σελήνη· διὸ καὶ οἱ κλήροι τούτων ἀπὸ τούτων εὐρίσκονται τῶν θεῶν ἐν ταῖς γενέσεσιν ἡμῶν, ὡς ἐστὶν δῆλον τοῖς περὶ ἀστρολογίαν γεγυμνασμένοις.

24 See R. Waterfield, 'The Evidence for Astrology in Classical Greece', *Culture and Cosmos* 3.2 (1999): 3–15, here 6, 11, who is of the same opinion.

assign character traits to ‘planetary’ lots. All these connect lots with a person’s ‘fate’, fortunate or unfortunate, as dispensed by a divine heaven.

Since it is formed by projecting the arc between two points from a third point, the lot, obviously, is invisible and non-corporeal (in that it is not an actual body in space). Nevertheless (or maybe we should suggest the opposite sentiment, ‘so therefore’, given the philosophical superiority of invisible and non-corporeal beings) its impact in the chart is given some weight—just as the Ascendant and Midheaven, though not actual bodies, have importance. However, unlike the Ascendant and Midheaven (and the Moon’s Nodes as well), the lot is a purely mathematical construct which has no physical basis (other than deriving secondarily from the positions of physical bodies). The lots, though based on observable points, carry the ratio of those points a step further than the non-corporeal points of the Ascendant, Midheaven and Nodes. Since they form a ratio (the distance between the two points used in the lot is proportional to the distance from the Ascendant), we may compare this to the way that Plato describes the casting of lots (*κατὰ λόγον*, by proportion or ratio) in the *Laws* as including a prayer to receive the proportional justice of Zeus (see above, 281). In this way the astrological lots, with their built-in proportion, may come nearer to the gods, or nearer to what the gods intend.

The earliest information on the Lot of Fortune appears in the writings ascribed to Nechepso and Petosiris. It has particular importance in helping to determine length of life²⁵ and whether particular times of life are effective or not; the Lot of Daimon also plays a part in these doctrines²⁶ (see Chapter Nine, section 7). This material shows the earliest Greek astrology using the lot to discover information about the length and productivity of human life. Ptolemy and Hephaestio especially use the Lot of Fortune in length of life prediction; in Dorotheus, the Lots of Fortune and Daimon are involved in infant vitality:

Look concerning the matters of bringing up at the lot of fortune and the lot of the demon. If you find the Moon with one of them or aspecting them in trine, this is a good indication in the matter of bringing up, and this is an indicator of the beauty of his face and the perfection of his

25 See, e.g. Valens, III, 11.3 (Pingree, 146.26–147.1), in connection with length of life determinations.

26 *Ibid.*, III, 11, esp. III, 11.12; IV, 4; IX, 2, esp. IX, 2.5 (Petosiris and Nechepso are quoted in IX, 2.7–8). For the Lot of Fortune see also VII, 6, though it is not completely certain that the Lot of Fortune is always being considered here.

limbs and the sprouting of his teeth without discomfort. If the Moon is free from these two, say the contrary to what I said.²⁷

In this doctrine the Moon, as a nutritive body, works with the Lots of Fortune and Daimon. The importance of both physical nurturing and bodily normality is not insignificant in Greek astrology.²⁸ In the Greek fragments of Dorotheus, this paragraph is paraphrased in the Nativity of Constantine VII Porphyrogenitus: ‘Thus according to Dorotheus: when the Moon happens to be with the Lot of Daimon, it signifies the offspring will be well-nourished and produce teeth without trouble.’²⁹

Other astrologers are interested in the quality of life the lots provide (e.g. Vettius Valens, ‘Antiochus’³⁰ and Rhetorius). Appendices 8.A, 8.B and 8.C contain descriptions, formulae and interpretations of these three authors. We shall discuss the lot technique of Julius Firmicus Maternus in the next chapter; I mention here only that he uses several lots associated with daimon and/or fortune: *Cupido*, *Necessitas*, *Basis* and *Nemesis*.³¹ The Nemesis lot uses Fortune and the Moon in its calculation: (positions of) Asc + Moon – Fortune (N) and Asc + Fortune – Moon (D). This is an interesting combination, because Nemesis is associated with the goddess Tyche in religious cults,³² and Tyche (Fortune) is the Moon’s lot. The word ‘nemesis’, which derives from the verb νέμω, has to do with receiving one’s due.³³ Again we connect to allotment and the daimon, who also fulfils the chosen destiny. As with the Lot of Nemesis, Firmicus also uses the Greek word for the Lot of Basis, with the following formula: Asc + Daimon – Fortune (N) and Asc + Fortune – Daimon (D). This lot will also be

27 Dorotheus, I, 9 (Pingree, 167).

28 See, e.g., Ptolemy, *Tetrabiblos*, III, chs 9 (‘On Monsters’) and 10 (‘On Children who are Unnourished’). Similar passages are in Hephaestio, II, 9 and 10 (these are largely based on Ptolemy, however).

29 In Dorotheus, Pingree, 327.10–12 (= fr. 22 Stegemann; III, 2 in horoscope of Constantine): Κατὰ δὲ Δωρόθεον οὕτως· ἢ Σελήνη μετὰ τοῦ κλήρου τοῦ δαί<μονος> τυχοῦσα εὐτροφον σημαίνει τὸ τεχνεῖν καὶ ἀπόνως ἐκφυῆναι <τοὺς> ὀδόντας.

30 In quotation marks because part of Rhetorius’s excerpt here is actually a close copy of Paulus.

31 Firmicus, VI.32.45–46 for *Cupido* and *Necessitas*; VI, 32.56 for *Nemesis* and *Basis* (KSZ, II, 189.21–22, 23; Monat, III, 128): ‘Nemesis nocte a Fortuna ad Lunam, . . . basis nocte a fortuna ad genium.

32 See, e.g., Edwards, ‘Tyche at Corinth’, 532–33, 535–37.

33 LSJ, s.v. See also D. Grene, ‘Herodotus: The Historian as Dramatist’, *JPh* 58, no. 18 (1961): 477–88, here 481.

examined in Chapter Nine. *Cupido* and *necessitas* (Greek Eros and Ananke) will be discussed in Chapter Ten.

The following case studies, on Manilius, and Paulus and Olympiodorus, will demonstrate clear links between the lot doctrine of astrologers and the lot doctrine of Hellenistic culture, including connections to divination and the daimon.

2.1 *Manilius and the Circle of Athla*

Manilius connects the lots to fate from a Stoic³⁴ (rather than Platonic) point of view. His position takes up a substantial chunk of Book 3 of the *Astronomica* (more than 125 lines out of almost 700), and he is almost unique among astrological authors in describing in great detail a place system based on where the Lot of Fortune falls.³⁵ This system is in marked contrast to his descriptions of the places based on where the Hour-marker, or Ascendant, falls (the degree and sign on the eastern horizon at the moment of birth). The lot places have their own special meanings, all of which have to do with specific areas of life, unlike the meanings of the places starting from the Ascendant sign, which are described in more general terms as being favourable or unfavourable and are associated with various planets/gods.³⁶ These places from the Ascendant often take their meanings from where the place lies in the diagram of the sky that the chart represents, with particular attention to where they lie in relation to the horizon and meridian.

34 Scholarship has fairly unanimously identified Manilius's Stoic tendencies. See, e.g., Goold in Manilius, *Astronomica*, Introduction, xxxvii (Loeb); W. Hübner, 'Manilius als Astrologe und Dichter', in *ANRW*, vol. II.32.1, ed. Wolfgang Haase (Berlin/New York: Walter de Gruyter & Co., 1984), 126–320, here 234–36; and F. Cumont, *Astrology and Religion among the Greeks and Romans* (New York/London: G. P. Putnam's Sons, 1912), 85; recently K. Volk, *Manilius and his Intellectual Background* (Oxford: Oxford University Press, 2009), esp. 226–34 (she also discusses other influences); T. Habinek, 'Manilius' Conflicted Stoicism', in *Forgotten Stars: Rediscovering Manilius' Astronomica*, ed. Steven J. Green and Katharina Volk (Oxford: Oxford University Press, 2011). Among other indications, Manilius's treatment of the elements and his belief in the power of fate show his Stoic inclinations.

35 Valens describes such a system as well, but not nearly in the detail that Manilius does; and Valens' descriptions are very different from those of Manilius. However, Valens does give examples using this technique. See Chapter 9.

36 The only specific areas of life mentioned in the place system from the Ascendant are health (6th place), brothers (3rd), marriage (10th), fathers (4th) and children (1st). The lot places, by contrast, mention many more areas of life (see below, Figure 8.1, Circle of Athla).

For Manilius, the 'lot places' combine with the other ways of arranging the sky and help to personalise the chart, to make it a unique expression of a person's fate. The Lot of Fortune individualises that fate. Because it not only derives from the Ascendant (arguably the most personal degree because it is based on the time and place of birth), but also is combined with the positions of the Sun and Moon projected from the Ascendant, this qualifies it to be the arbiter and allotter of the events of a life. By creating a system of places based on and starting from the Lot of Fortune, Manilius astrologically mimics the casting out of the lot; where it falls is where the fate begins.

With a choice of words that emphasises the connection to fate and proper allotment, Manilius tells us that everything in the sky is allotted its own recompense, and all is part of the fulfilment of destiny. '... to each [zodiac sign] she consecrated its own reciprocal service and fulfilled the sum total in every respect, so that the rendering of fate should be drawn from everywhere into a single whole' (3.64–66).³⁷ Here are words like 'vices', reciprocal service, or recompense, what the sign 'in turn' gives back.³⁸ The recompense is 'consecrated' (*sacrare*), and the whole 'fulfilled' (*sancire*), a word which has the sense of fulfilling a prophecy or ratifying a law.

These are the fixed laws of the universe: in his lead-up to the description of lot places, Manilius emphasises nature's fixity of the heavens, the fixed order by which the world operates, the fixing in the sky of the zodiac and the planets tied to human fate. He says '... by fixed rules she joined separate limbs into a single body...' (3.50–51); '... she assigned... fixed functions, and conducted the whole inventory of a human's condition under a fixed system...' (3.71–73).³⁹ When he begins to talk about the lot apportionments and their relationship to the zodiac, by contrast, he uses words of fluidity and impermanence, as if to acknowledge the individual, particular contribution the lots give to each person.

The lots of these activities she allocated each to a sign, *not* in such a way that they should *remain* in a *permanent* quarter of the sky... but so that

37 Manilius, *Astronomica*, 3.64–66 (Goold): '... propriasque sacravit / unicuique vices sanxitque per omnia summam, / undique uti fati ratio traheretur in unum.'

38 *Vices* (there is no nominative singular) has the sense of alternation and reciprocity; it can also mean 'hap' or 'fortune', probably deriving from its fundamental meaning of 'change' (Lewis and Short, s.v.).

39 Manilius, *Astronomica*, 3.50–51 (Goold): '... diversaque membra / ordinibus certis sociaret corpus in unum...'; 3.71–73: '... certasque vices... /attribuit, totumque hominis per sidera censum ordine sub certo duxit...'

they should receive their proper position according to the moment of birth and *change* from sign to sign, each lot at a *different time* moving to a *different constellation*, so that the nativity then meets with a *new pattern* in the zodiac. . . .⁴⁰ (Italics mine.)

The activities of the lot places are fixed, since the lots go in zodiacal order, but the beginning sign, i.e. the allotment, is fluid, based on the position of the Lot of Fortune, which in turn is based on the time of birth, the moment when the allotment begins. 'For they [the activities] do not keep permanent homes or preserve the same stars for every person born, but they change with time, moving now hither, now thither, through the circle of signs . . .'⁴¹ In a way, this is a doubly fluid system, since it is already building on the shifting of the Ascendant for each birth.

Manilius calls the lot places *athla* from the Greek word for contest, and they are described as *aerumnosus*, 'toilsome' (3.172) in Goold's translation, suggesting that life, at least the life that the lot apportions, is an uphill battle. We are probably also to be reminded of the twelve *athla*, or labours, of Heracles for which, as M. L. West plausibly argues, there seem to be some cosmological-astrological connections.⁴² It is important to note here that Manilius uses a number of other words to describe the lots and their places: *sors*, *pars*, *locus*, *sedes*. *Sors* has the same range of meanings as κλήρος, and could fairly be said to be its Latin equivalent. Manilius is careful to use it when referring specifically to the Lot of Fortune, e.g. 'the first lot has been given to Fortune.'⁴³ In apposition to *sors* is *pars*, which means 'a portion', but specifically here the portion assigned to the lot, *sors*.⁴⁴ For Manilius, the *sors* allots the *pars*. Contrasted

40 Ibid., 3.75–81: 'horum operum sortes ad singula signa locavit, / non ut in aeterna caeli statione manerent / et cunctos hominum pariter traherentur in ortus / ex isdem repetita locis, sed tempore sedes / nascentum acciperent proprias signisque migrarent / atque alias alii sors quaeque accederet astro, ut caperet genitura novam per sidera formam . . .'. Goold's translation.

41 Ibid., 3.165–167: 'perpetuas neque enim sedes eademve per omnis / sidera nascentis retinent, sed tempore mutant, / nunc huc nunc illuc signorum mota per orbem. . .'. Goold's translation, modified.

42 M. L. West, *The Orphic Poems* (Oxford: Oxford University Press, 1983, repr. 1984), 192–94. He connects Heracles' Twelve Labours with the Platonic Great Year, and also with a Stoic allegory of the myth, citing Cleanthes as the probable source. Since Manilius's outlook is primarily Stoic, for him to make the same connection would not be improbable. (For more on Orphic connections to astrology, see Chapter 10.)

43 Manilius, *Astronomica*, 3.96 (Goold): 'Fortunae sors prima data est.'

44 Ibid.; see 3.67–85, which shows the contrast between these words.

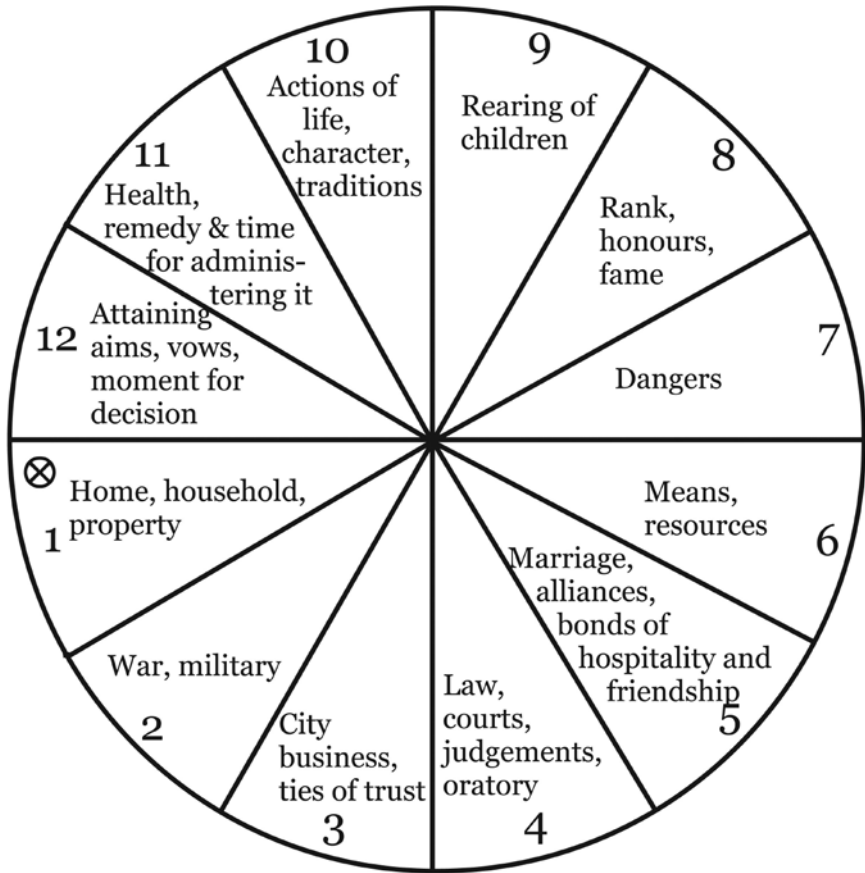

FIGURE 8.1 Manilius's Circle of Athla, or places from the Lot of Fortune.

to these two words are 'place' words like *locus*, *sedes*, *statio* and *gradus*: these are used by the poet to tell us where the lot 'place' falls in the order it takes from the Lot of Fortune.⁴⁵ It is as if these words bring into actuality the apportionment of the lot; they place it in the business of the material world.

In his descriptions of the second through the tenth lot 'places' Manilius uses all these 'place' words. But in the description of the eleventh lot place,

45 Actually, Manilius calls the places from the Lot of Fortune 'lots', *sortes*, as if they are secondary lots in themselves. Where this lot falls is a 'locus', place (the second, fourth, ninth and tenth); a 'statio', station (the third); a 'gradus', step (the fifth); a 'sedes', seat (the sixth, seventh and eighth). Each 'place' variant also serves a different metrical function. See 3.102–137.

he reverts to the word *pars*, and also reminds us that what makes the *pars* is the *sors*: 'Outstanding is the portion located in the eleventh lot.'⁴⁶ These words take us back to the idea of divination, of allotment by divine sanction. In the eleventh and twelfth lot places Manilius describes not only apportionments which arrive at birth, but also refers to what are called elections and interrogations, both of which are included in katarthic astrology.⁴⁷ This seems to imply that the lot places from Fortune are used not only in natal astrology, but in the astrology of choosing or interpreting 'moments' in later time (this is different from predictive techniques like profections). The eleventh place is where one can find the 'choice of remedy and the moment for administering it, or in whose hour therapy and the mixing of life-saving potions have greater efficacy'.⁴⁸ The twelfth, Manilius says, gives us information on whether we should take a job or initiate a lawsuit, whether our crops will succeed or fail—'this is the portion in which day and hour for a decision shall be given, if the planets as they move through the zodiac are favourably situated' (3.149–155).⁴⁹

Notably, the two places so qualified to provide this information are the eleventh and twelfth from the Lot of Fortune. The eleventh from Fortune is a place of acquisition in Vettius Valens. The association of this place with Jupiter and with the Agathos Daimon makes this a logical assignment. But this powerful assignment of decision-making to the *twelfth* place from Fortune is curious. In the normal scheme of the twelve places, the twelfth place has negative implications for the native. However, it is also called *metakosmios*, 'between worlds'.⁵⁰ Is this, then a place where the daimonic can move between and thereby connect the divine and human realms? The liminal space is often connected with divination.⁵¹ Could we also consider this place, as the one that

46 Manilius, *Astronomica*, 3.138 (Goold): 'Praecipua undecima pars est in sorte locata'.

47 Goold has also noticed this connection: see his introduction (Loeb translation), lxiv–lxv; as has S. Feraboli: M. Manilius, *Il poema degli astri (Astronomica)*, Edited by Enrico Flores, translation and commentary by Riccardo Scarcia, commentary by Simonetta Feraboli, 2 vols (Milan: Fondazione Lorenzo Valla, Arnoldo Mondadori Editore, 1996, 2001), II, 261.

48 Manilius, *Astronomica*, 3.142–144 (Goold): '...tempusve genusve medendi / quae sibi deposcat vel cuius tempore praestet / auxilium et vitae sucos miscere salubris.'

49 Ibid. This is the entire passage described here (quotation in italics): 'seu ferat officium nutus blanditus in omnis, / aspera sive foro per litem iurgia temptet, / fortunamve petat pelago ventisque sequatur, / seu Cererem plena vincentem credita messe / aut repetat Bacchum per pingua musta fluentem, / hac in parte dies atque hac momenta dabuntur, / si bene convenient stellae per signa sequentes'.

50 Rhetorius, *CCAG*, VIII/4, 126 (12th), 154 (6th), 144 (3rd), 163 (9th). (See Chapter 4, 145.)

51 See Chapter 4, 145 and n. 145.

first rises from Fortune, similar to a planet heliacally rising from the Sun, and therefore becoming powerful and efficacious?

Let us consider further the significance of the fact that it is the eleventh and twelfth places from Fortune which are associated with katarchic astrology, which is inherently divinational in nature. Note that in the normal assignation of the twelve places from the Ascendant, the eleventh and twelfth are places of the *daimōn*, in both good and bad manifestation. We have seen the *daimōn*'s association with divinatory practices such as oracles and the casting of lots. There is also evidence of connections between Fortune and Daimon (as divinities) in religious areas. Might some of these same connections apply here in Manilius's delineation of the eleventh and twelfth places from Fortune, and his linking them to katarchic astrology? Are the clear katarchic references limited to the eleventh and twelfth places because of connections to the daimon and divination? Bouché-Leclercq points out a highly interesting correlation between some of these 'lot places' and the sixteen regions of the liver in Etruscan divination.⁵² (A bronze model of a liver found at Piacenza, Italy in 1877 has provided much information about this kind of divination.)⁵³ The regions of the liver were assigned to divinities, and also were correlated to the heavens (thus relating to divination by lightning, another Etruscan divinatory specialty). Both Pliny (*HN* II, 55.143–144) and Cicero (*De div.* II, 18.42) speak about the sixteen regions of the heavens, and their attributions in divination by lightning. The division of the sky into sixteen portions is also peculiarly Etruscan. Martianus Capella's list of sixteen regions linked to divinities has been shown to have Etruscan and astrological connotations by both Carl Thulin and Stefan Weinstock.⁵⁴ (It is interesting for our purposes to note that a number of these are minor divinities who could certainly be classed as the equivalent of daimons, including *lares* and *di manes*.) In addition, some of these regions correlate with Manilius's descriptions of lot places.

52 Bouché-Leclercq, *AG*, 298 n. 2. See also his *Histoire de la divination dans l'antiquité*, 4 vols. (Paris: E. Leroux, 1879–1882), here vol. 4, 24–28.

53 See, among others, C. Thulin, *Die götter des Martianus Capella und der bronzeleber von Piacenza*, vol. 3.1 (Giessen: A. Töpelmann, 1906); M. Pallottino, 'Deorum sedes', in *Studi in onore di Aristide Calderini e Roberto Paribeni*, 3 vols., vol. 3 (Milan: Ceschina, 1956–1957), 223–34; and especially L. B. van der Meer, *The Bronze Liver of Piacenza: Analysis of a Polytheistic Structure* (Amsterdam: J. C. Gieben, 1987), including his bibliography.

54 Thulin, *Die Götter des Martianus Capella*; S. Weinstock, 'Martianus Capella and the Cosmic System of the Etruscans', *JRS* 36.1 and 2 (1946): 101–29. Others such as van der Meer have also studied the connections between the Piacenza liver and Martianus Capella; see van der Meer, *Bronze Liver of Piacenza*; also idem, 'Iecur Placentinum and the Orientation of the Etruscan Haruspex', *BABesch* 54 (1979): 49–58, esp. 50; also A. Aveni and G. Romano, 'Orientation and Etruscan Ritual', *Antiquity* 68 (1994): 545–63, esp. 550–54.

TABLE 8.1 *Comparison of Martianus Capella and Manilius*⁵⁵ (similarities in **bold typeface**)

From Martianus Capella, 1.45–61	From Manilius, 3.96–155
Region One: Jupiter; gods of the council, god of welfare, household gods , Janus, secret gods of goodwill, god of night	First portion: Fortune, home, household, property
Region Two: Mars Quirinus and Lars the warrior ; Jupiter, Juno, Fons; the Lymphae; nine gods of lightning	Second portion: place of warfare/ army (<i>locus militiae</i>); foreign wars and cities
Region Five: Domains of the royal couple , Ceres, Tellurus, ⁵⁶ Vulcan, Genius	Fifth portion: Marriage ; alliances of hosts and guests; bonds of friendship
Region Seven: Liber; Pales of the second rank; Deceit	Seventh portion: Dangers
Region Nine: Genius of Juno of Hospitality or Nurturing (<i>hospitae</i> or <i>sospitae</i>) ⁵⁷	Ninth portion: Rearing of children
Region Eleven: Fortune; Health; Goodwill	Eleventh portion: whole being and health ; remedies and when to administer them

It is true that we are here making a sixteen-fold division correspond to a twelve-fold one, but it is hard to deny that the similarity between the descriptions of

55 Martianus Capella, *De nuptiis Philologiae et Mercurii*, ed. Adolf Dick, with additions and corrections by Jean Préaux (Stuttgart B. G. Teubner, 1969; reprint, 1978), 27–29; van der Meer, *Bronze Liver of Piacenza*, 175–77; the translations of Stahl, Johnson and Burge in *Martianus Capella and the Seven Liberal Arts*, vol. 2. *The Marriage of Philology and Mercury*, 22–24; and D. Shanzer, *A Philosophical and Literary Commentary on Martianus Capella's De Nuptiis Philologiae et Mercurii Book 1* (Berkeley/Los Angeles: University of California Press, 1986), 213–14. See also Thulin, *Die Götter des Martianus Capella*, 60–61.

56 Thulin, *Die Götter des Martianus Capella*, 3 and n. 11, suggests that Ceres and Tellurus be combined: 'Ceres Tellurus (= Genius Telluris)'.
 57 'Sospitae' is in one manuscript. See Martianus Capella, *De nuptiis*, ed. Dick, 28.20–21 and *apparatus criticus* for line 21 (Liber 1. 54).

the Regions of Martianus Capella and the lot places of Manilius is not deliberate. Still other portions of both the Piacenza liver (especially when one considers the orientation of the liver) and Martianus Capella's list may correspond to Manilius's twelve-part place scheme from the Ascendant, and to his 'octotropos'. Manilius seems to make a synthesis of several different systems here, creating his own personal system by combining Hellenistic astrological doctrines with Etruscan divinatory ones. As far as the connection between liver divination and astrology in general goes, let us just remark that the Babylonian 'horoscopes' also have some commonalities with Babylonian extispicy texts.⁵⁸

Manilius finishes with careful instructions on how to calculate the Lot based on the sect of the chart (3.176–200).⁵⁹ Whether the chart is diurnal or nocturnal (thus changing the lot formula) is an important criterion.

2.2 Paulus, Olympiodorus and the 'Hermetic' Lots

Possibly because his descriptions of the lots are so clear, Paulus (along with his commentator Olympiodorus) is the Hellenistic astrologer most often quoted by secondary sources on lot doctrine.⁶⁰ We learn from Paulus that the 'planetary' lots described in Rhetorius's excerpt of Antiochus's *Thesaurus* (whose words appear in Paulus as well; see Appendix 8.B) come from a book called the *Panaretus* ('All-Virtue'), ascribed to Hermes Trismegistus. (The names used for the planetary lots also, strangely, figure in a list of decans in Cosmas of Jerusalem: see Chapter Six, 4.8.) Paulus gives their formulae.⁶¹ Each of the seven lots so described is formed by the arcs between their respective planets taken either from the Lot of Fortune or the Lot of Daimon.

58 See F. Rochberg, *Babylonian Horoscopes*, TAPS, vol. 88, part 1 (Philadelphia: American Philosophical Society, 1998), 16.

59 Bouché-Leclercq, *AG*, 289 and n. 4, seems to think that Manilius had one formula for both the day and night positions of the Lot of Fortune, or that both of his formulae produced the same place for the lot. I disagree; I think Manilius 1) would not have mentioned two methods if two positions were not going to result and 2) is clear in his wording that two places for the lot, differentiated by night and day, are meant. Goold, in his explanation of the Lots (Manilius, *Astronomica*, pp. lxxv–lxxviii), interprets Manilius correctly. Dora Liuzzi has followed the (incorrect) reasoning of Bouché-Leclercq in her commentary on Manilius Book III; see M. Manilius, *M. Manilio Astronomica libro terzo*, ed. and trans. Dora Liuzzi (Lecce: Milella Editore, 1988), Introduction, 9 and commentary, 97–98.

60 He is quoted by Bouché-Leclercq, Neugebauer and Van Hoesen, Barton, Tester, Holden and Bezza, among others.

61 See Paulus, ch. 23, Περι τῶν ἑπτα κλήρων τῶν ἐν τῇ Παναρέτῳ.

TABLE 8.2 *'Hermetic' lots in Paulus and Olympiodorus*⁶²

Lot of Fortune (Moon) ὁ τῆς Τύχης κλήρος	ASC + Moon – Sun (D) ASC + Sun – Moon (N)
Lot of Daimon (Sun) ὁ τοῦ Δαίμονος κλήρος	ASC + Sun – Moon (D) ASC + Moon – Sun (N)
Lot of Necessity (Mercury) ὁ κλήρος τῆς Ἀνάγκης	ASC + Fortune – Mercury (D) ASC + Mercury – Fortune (N)
Lot of Eros (Venus) ὁ κλήρος τῆς Ἐρωτος	ASC + Venus – Daimon (D) ASC + Daimon – Venus (N)
Lot of Courage (Mars) ὁ κλήρος τῆς Τόλμης	ASC + Fortune – Mars (D) ASC + Mars – Fortune (N)
Lot of Victory (Jupiter) ὁ κλήρος τῆς Νίκης	ASC + Jupiter – Daimon (D) ASC + Daimon – Jupiter (N)
Lot of Nemesis (Saturn) ὁ κλήρος τῆς Νεμέσεως	ASC + Fortune – Saturn (D) ASC + Saturn – Fortune (N)

Olympiodorus quotes, mostly verbatim, Paulus's descriptions of lots, but also adds some useful commentary, referring to the body and soul attributes of the Lots of Fortune and Daimon:

Then after this [*the Lot of Fortune*], [we look at] the Lot of the Good Daimon,⁶³ since we can get to know the character of the soul, intentional mind and purpose from this [lot], just as [we learn] the body and things concerning the body from Fortune. Especially concerning these things, the greatest power of divination abides with knowing the character of the soul and instruction about the body; that is to say, how a soul having come from above, is here a citizen in the cosmos, and how she will

62 Paulus, ch. 23; Olympiodorus, chs 21 and 22.

63 This is a rare instance where the Lot is called 'Good Daimon' and not just 'Daimon'. It may betray the lot's innate benefic character.

encounter the body and things concerning the body and, speaking generally, all the things which are not up to us.⁶⁴

In Olympiodorus's comment we see a direct connection, through their attributes, between the lots and divination. In another passage, Olympiodorus emphasises the importance of the Lots of Fortune and Daimon by pointing out that unless we know where they fall, we cannot compute any of the other 'planetary' lots.⁶⁵

Note, in the table above, that the lots of the malefics, Mars and Saturn, use the Lot of Fortune in their calculation, but the benefics, Venus and Jupiter, use the Lot of Daimon. Mercury's lot, the Lot of Necessity, also uses the Lot of Fortune. Why might this be the case? Fortune connects to the physical plane and the material world of generation and corruption. Those lots which use it may be seen as connected to the chance happenings over which humans have no control. The malefic planets with Fortune reinforce the difficulty of changing physical circumstances. The lots using Daimon, on the other hand, link with the conscious and the intentional, and the ability of humans to reason. The benefic planets with Daimon reinforce the possibility of choosing intention and free will. The daimon, in its role as a guardian spirit and personal guide, connected to the rational soul and with some access to providence

64 Olympiodorus, ch. 22 (Boer, 46.13–47.5): Ἐῖτα μετὰ ταύτην τὸν τοῦ Ἀγαθοῦ Δαίμονος, ἐπειδὴ ἦθη ψυχῆς καὶ φρόνησιν καὶ προαίρεσιν ἐκ τούτου δυνάμεθα γινώσκειν, ὡσπερ ἐκ τῆς Τύχης περὶ τοῦ σώματος καὶ τῶν περὶ τὸ σῶμα. περὶ ταῦτα δὲ μάλιστα ἢ μεγίστη μαντεία καταγίνεται τοῦ γνῶναι ἦθη ψυχῆς καὶ διαγωγὴν σώματος, ταῦτόν δὲ εἰπεῖν, πῶς μὲν ψυχὴ πολιτεύεται κατὰ τὸν τῆδε κόσμον, ἄνωθεν ἔλθοῦσα, πῶς δὲ τὸ σῶμα καὶ τὰ περὶ τὸ σῶμα, καὶ ἀπλῶς εἰπεῖν, πάντα τὰ οὐκ ἐφ' ἡμῖν ὑπαντήσει. (See also Olympiodorus in Greenbaum, trans., *Late Classical Astrology*, 103–04.) This passage is filled with Stoic allusions. Note the phrase 'οὐκ ἐφ' ἡμῖν'. What is 'up to us' is a question long considered in philosophical writings on fate and determinism (we have seen Porphyry's version). In the *Manual* of Epictetus, 1, we find: 'Of all existing things some are in our power [i.e., up to us], and others are not in our power. In our power are thought, impulse, will to get and will to avoid, and, in a word, everything which is our own doing. Things not in our power include the body, property, reputation, office, and in a word, everything which is not our own doing' (trans. P. E. Matheson in W. J. Oates, ed., *The Stoic and Epicurean Philosophers: The Complete Extant Writings of Epicurus, Epictetus, Lucretius, Marcus Aurelius* (New York: Random House, 1940), 468). We have seen Porphyry take up this question in light of astrology. See also discussion of this passage in M. Lawrence, 'The Meaning of Astrology for Late Neoplatonists'.

65 Olympiodorus, ch. 22 (Boer, 47.5–10): τούτου χάριν πρὸ πάντων τῶν κλήρων τὸν τοῦ Δαίμονος καὶ τῆς Τύχης κλήρον ζητητέον. ἀλλὰ μὴν καὶ ἑτέραν αἰτίαν εἶπε, ὅτι διὰ τοῦτο τὸν τοῦ Δαίμονος καὶ τῆς Τύχης κλήρον δεῖ προεμβάλλειν, ἐπειδὴ ἀπὸ τούτων καὶ τοὺς ἄλλους πάντας ἐκβάλλομεν. οὐκ ἡδυνάμεθα οὖν τούτων μὴ ἐκβληθέντων τοὺς λοιποὺς ἐκβάλλειν. (See also Olympiodorus in Greenbaum, trans., *Late Classical Astrology*, 104.)

and foreknowledge, can steer a human toward this non-predestined path; the Daimon lots may represent this as well.

Each planetary lot embraces qualities associated with that planet. (For descriptions of these lots in Paulus and Olympiodorus, see Appendix 8.D.) Regarding the Moon's and Sun's lots—Fortune and Daimon—let us just say that, since these lots are formed from both the Sun and Moon, they bring in both of those qualities in varying degrees and under different circumstances. For Saturn, the Lot of Nemesis, retribution, has to do with getting what one is due, and with the final allotment, which is death. (Note that Paulus's formula for this lot is different from the one given by Firmicus.) For Jupiter, the Lot of Victory shows the quality of success, of attainment. For Mars, the Lot of Courage shows boldness but also rashness. For Venus, the Lot of Eros has to do with voluntary associations. Only for Mercury does the Lot of Necessity not seem to correlate well with its planetary attributes. It signifies enemies and constraining circumstances, which do not seem related to anything Mercurial. Olympiodorus strains a little, I think, when he says that 'since Hermes is lord of reason, and reason is actually necessary, for this reason he [Hermes Trismegistus] called his lot Necessity.'⁶⁶

Giuseppe Bezza has pointed out that in these planetary lots we find the purest, most unadulterated expression of that planet, uncontaminated by either the sign, the place in which it falls or its aspects to other planets.⁶⁷ I would add that unlike the other lots, these lots represent abstract concepts which, though expressed in material outcomes by the astrologers, also take into account states of mind and emotion for the holder of the chart.

3 Some Reflections

There is a strange consistency in these 'abstract' lots: the names given to them are abstract qualities which have been personalised in Greek religion, often as daimons. Walter Burkert tells us that '*Daimon* is the veiled countenance of divine activity.'⁶⁸ Are these lots ways for the daimonic to show itself in the

66 Olympiodorus, (Boer, 42.22–43.2): ... ἀλλὰ μὴν ἐπειδὴ καὶ ὁ Ἑρμῆς κύριός ἐστι λόγου, ὁ δὲ λόγος ἀναγκαστικός ὑπάρχει, τοῦτου χάριν Ἀνάγκην ἐκάλεσε τὸν κληρὸν αὐτοῦ. ... (See also Greenbaum, trans., *Late Classical Astrology*, 102.) We shall see, in Chapter 10, reasons for the meaning of this lot which have nothing to do with Hermes/Mercury.

67 Bezza, *AM*, vol. 2, 970.

68 Burkert, *Greek Religion*, 180.

chart? Tolma, Eros, Ananke, Nike, Nemesis—all have daimonic connections.⁶⁹ We have seen the odd correlations of the lot places in Manilius with the regions of the sky ascribed to what could be considered daimonic divinities in Martianus Capella. The cults of Agathe Tyche and Agathos Daimon (whose functions as guardians and protectors of humans seem more daimonic than godly) arise in Alexandria and the Greek islands at the same time that Greek astrology is being developed. The lots, in fact, mediate between the gods (planets) and humans (represented by the Ascendant) just as the daimons do.

These lots are named for abstractions—emotions, spiritual concepts, philosophical ideas, mental states. Daimons named for abstractions might suggest that the states of mind and body so indicated are part of a divine heritage which, like the daimons themselves, links us to the gods. As Burkert says, ‘*Daimon* does not designate a specific class of divine beings, but a peculiar mode of activity.’⁷⁰

Then there is the idea of the lots as points of personal destiny,⁷¹ originating from the first lot, the Lot of Fortune, and the second lot, the Lot of Daimon. Just the names ‘Tyche’ and ‘Daimon’ beg for this correlation to destiny, as do the words *κλήρος* and *sors*. In astrology, the Ascendant provides the personal aspect as a zodiacal translation of the time and place of birth, which mathematically is far more personal a point in the chart than, say, the Midheaven.⁷²

The astrological lots evoke, and translate into an astrological context, the cultural use of lots to allot people jobs in civil government. When Bezza remarks that the lots show the planets in their purest form, what may underlie his think-

69 See H. Nowak, *Zur Entwicklungsgeschichte des Begriffes Daimon: eine Untersuchung epigraphischer Zeugnisse vom 5. Jh. v. Chr. bis zum 5. Jh. n. Chr.* (Bonn: Rheinische Friedrich-Wilhelms-Universität, 1960), 16–17, for epigraphy which associates some of these names with daimons. Empedocles, Parmenides and Plato also refer to some of these as daimons (see Chapter 10); and see Cosmas of Jerusalem in Chapter 6, 4.8. This would fit with the idea of daimonic power—for instance, the power of courage, love, necessity, etc., representing some kind of divine force.

70 Burkert, *Greek Religion*, 180 (one suspects his view comes from the Hermetic material which associates daimons with *energeia*). But in Classical and post-Classical Greece, one sees daimons also as specific divine beings, usually expressing abstract concepts or emotions. So the concept of daimon becomes more multi-valent.

71 Giuseppe Bezza has also put forth this idea, at least for the idea of the lot in general (but with an implication for the astrological lots, it seems to me): see *AM*, vol. 2, 964: ‘Ma il kleros, per lo più sotto forma di un dischetto o di un ossicino, è anche la sorte che porta con sé la personalità dell’individuo e che una divinità trae, fissandone il destino.’ (‘But the kleros, whether in the form of a sherd or a small bone, is also the lot that carries with itself the personality of the individual and that a divinity casts, securing the destiny.’).

72 The Midheaven degree is the same at all latitudes, but the Ascendant degree is based on both longitude and latitude, and both must be considered in calculation.

ing is the idea of the impartiality which casting lots provides. Yet as Plato reminds us, the equality of the lot does not provide proportional justice, a justice based on merit. Is this true in astrology? One could make the case both ways. Even if the Ascendant changes in the chart, as it will depending on the time of day, the distance of the lot from the Ascendant will always be fairly consistent on that day. Yet when we bring in the idea of reversing the day formula at night, we do more to personalise, and therefore take in more particular, merits of the chart. It is also true that the lots are an arithmetical construct, but they are founded on the idea of ratios which are proportional. One could also say that the particular arc between the points in the chart, and the particular Ascendant based on the time and place of birth, do mitigate the idea of complete impartiality: where the lot falls, whether fortunate or unfortunate, is based on the particular circumstances of the chart at birth.

Finally, what are we to make of the idea of lots in general, and of all these lots? It may seem as if the imposition of lots upon the chart in addition to planets results in needless clutter and confusion for the chart.⁷³ Certainly much scholarship seems mystified or disdainful about the multitude of techniques used by the Hellenistic astrologers. But those who belittle the myriad techniques employed by the astrologers and attribute to them an innate confusion and lack of rigour on the part of the astrologer may have missed the point. The astrologers, just as diviners, priests and philosophers, are searching for ways to show the connections between the heavenly and the human, and within the chart to show the power of the gods to influence human lives. The chart as a means of divination depends on having the most options available for interpretation. Lots, in fact, may represent a kind of divinatory ritual translated to the chart.

Gods and daimons form a divine network. If the planets themselves do not show a particular outcome in a life, the lots can provide another layer of interpretation for that life, one that may pick up an outcome not seen in the planetary picture alone. Certainly this kind of thinking, this piling of layers of technique on the chart to find answers, can be overblown and overused; multiple techniques overwhelm and become meaningless ways to make everything in a life correspond with the stars. It becomes not a *reductio* but a *multiplicatio ad absurdum*. The literal and material intrudes on the metaphorical and spiritual. Astrologers are as prone as anyone else to be seduced by the lure of technology.

But the use of the chart as a divinatory tool begs for multiple ways of interpretation; not everything has meaning, but that one particular thing that *is* meaningful must be available for the astrologer to see, often in a flash of insight and sense of rightness about the meaningfulness of a particular configuration

73 Other techniques such as *dodekatēmoría* and *monomoiría* could also be included.

in the chart.⁷⁴ In the world of daimonic reality, the metaphor is always present. It is as if, in the chart, the meaningful configuration sits quietly waiting to be noticed, and it is the task of the astrologer, with the client's aid, to find the meaningful interpretation from the (metaphorical) cacophony of sounds or multitude of images that present themselves to ear and eye.

The same configuration does not always mean the same thing. (The ancient astrologers acknowledge this.)⁷⁵ The skill of the astrologer is shown in his ability to find the unique metaphorical symbolism in the multivalency of meanings offered by astrological technique.⁷⁶

Here the lots affirm the divinatory origins of astrology. They come from the world of divination, of oracles, of the random toss of the bones that portrays, to those able to see the symbolism, the will of the gods. Yes, they are indeed things 'for which no cause can be reckoned'.⁷⁷ That is their fundamental divinatory function. They are points which cannot be seen, but only created in the mind. Because they are imaginal, not physical, they fall easily into a noumenal and symbolic space where the astrologer, in his interpretation, is able, like the daimon, to mediate between the worlds of gods and humans.

74 This kind of insight and sense of rightness is familiar to anyone involved in creative endeavours. As Patrick Harpur remarks in his book *Daimonic Reality: Understanding Otherworld Encounters* (London: Arkana Penguin, 1995), 250, '...every scholar, for instance, knows how the very book he requires can fall off a library shelf at his feet!' Also see M. Gladwell, *Blink: The Power of Thinking Without Thinking* (New York: Little, Brown & Company, 2005), esp. 107, 179–84. Gladwell calls the ability to synthesise and make judgements in an instant 'thin-slicing'.

75 For example, see Valens IV, 11.54 (Pingree, 168.1–2): ἐπει γὰρ δὴ δωδεκαετίας αἱ αὐταὶ παραδόσεις σημαίνονται, οὐ τὴν αὐτὴν ἐνέργειαν τῶν ἀποτελεσμάτων ἐφέξουσιν ἀλλὰ διάφορον. 'In fact, when the same handings over in a twelve-year period are interpreted, they will not possess the same actuality of outcomes, but different.'

76 T. Barton, 'Augustus and Capricorn: Astrological Polyvalency and Imperial Rhetoric', *JRS* 85 (1995): 33–51, here 39, acknowledges this multivalency. She makes insightful statements like 'a competent astrologer would improvise creatively' and '[Astrology] combined familiar, very rich symbols in new ways, so that a complex network of signs could be created' with 'enough density for astrological symbols to be read at different levels by different audiences'. Yet she still refers to the abundance of astrological techniques as an 'accretion of doctrines', and remarks that astrologers did not worry about 'contradictions'. In fact, the astrologer sorts through possibilities and applies the symbolism that is right at that particular place of interpretation. See G. Cornelius, 'Interpreting Interpretations: The Aphorism in the Practice of the Renaissance Astrologers', in *From Māshā'allāh to Kepler: Theory and Practice in Medieval and Renaissance Astrology*, ed. Charles Burnett and Dorian Gieseler Greenbaum (Ceredigion, Wales: Sophia Centre Press, 2015).

77 Ptolemy, *Tetr.* III, 4.4 (Hübner, 177.197):... διὰ κλήρων καὶ ἀριθμῶν ἀνατιτολογήτων... .

Endowment and Chance: The Lots of Fortune and Daimon

Δαίμων καὶ Τύχη bestimmen das Schicksal eines Menschen; selten, vielleicht niemals, einer dieser Mächte allein.¹

SIGMUND FREUD

We have seen daimon and fortune linked together in the chapters on the astrological places, as well as in the general discussion of lots in the previous chapter. Additional connections are presented in this chapter, which explores the technique and tradition of the Lots of Fortune and Daimon in Hellenistic astrology. This chapter will look not only at the various uses of these lots by Hellenistic astrologers, but also keep in mind the philosophical and religious underpinnings behind fortune and daimon. Are these underpinnings reflected in their astrological use, and are the links between fortune and daimon sustained in their use as astrological lots? Can the astrological lots enhance our understanding of the way that Fortune and Daimon were perceived in the Empire and Late Antiquity? This chapter will investigate these issues.

In this investigation, we should not forget that the Lots of Fortune and Daimon are closely linked through the way in which they are calculated, so that they become mirror images of each other in the chart. This entwinement may have implications for what they mean, how they are used, and why there has been confusion in finding the ‘correct’ calculation for them. They are the first pair of lots to be linked in this way;² that their names correlate to

-
- 1 ‘*Daimōn kai Tuchē* (Endowment and Chance) determine a man’s fate—rarely or never one of these powers alone.’ English translation in S. Freud, ‘The Dynamics of Transference’, in *The Standard Edition of the Complete Psychological Works of Sigmund Freud*, vol. XII, ed. James Strachey, et al. (London: The Hogarth Press, 1958, repr. 1981), 99, n. 2. German in S. Freud, ‘Zur Dynamik der Übertragung’, in *Gesammelte Werke*, Band 8, ed. Anna Freud et al. (London: Imago Publishing Company, 1943, repr. 1948), 364–65, n. 2. Freud left the Greek untranslated in the original; the Greek translation here is Strachey’s. While properly speaking ‘Endowment’ does not exactly translate ‘daimon’ (the daimon ‘endows’; it is not the endowment itself), by the use of the word ‘endowment’ a distinction is being made here between several concepts: nature vs. nurture, talent vs. luck, the innate vs. the external. We shall return to these themes at the end of this chapter.
 - 2 The other pair so entwined are the Lots of Eros and Necessity, to be discussed in the next chapter.

two most important concepts in Greek philosophy and religion may not be coincidental.

Of the seven ‘Hermetic lots’³ (the so-called planetary lots),⁴ the Lot of Fortune, followed by the Lot of Daimon, are used the most frequently in astrological technique. The philosophical link between the daimon and lots is amply demonstrated in Plato, as we saw in Chapter Eight. Fortune has a similar connection to lots. The cultural and historical uses of Tyche and Daimon supply some reasons why the Lots of Fortune and Daimon become important in Hellenistic astrology. That importance will be established by examining some of the history of their use in extant charts, investigating the formulae with which they are calculated and the techniques employing them. This examination may also shed some astrological light on the concept of lots and daimons in other contexts.

The Lot of Fortune is by far the lot most used in interpretation. It is mentioned by almost every Hellenistic astrologer. Of the 326 extant Greek charts,⁵ 88 (plus two)⁶ calculate the Lot of Fortune. The Lot of Daimon is second, with 33.⁷ (See my article for the extant charts containing these lots.)⁸

3 See the previous chapter.

4 Paulus associates one lot with each of the seven classical planets (including the luminaries). I use the phrase ‘so-called’ because in other authors the formulae for some of these lots do not use planets.

5 This sum includes the 23 charts in Vettius Valens, *Anthology* VIII, 7 and 8, which do not appear in the literary section of *Greek Horoscopes* (but are mentioned on 180–81). I have drawn from the collections in *GH*; Jones, *APO*; D. Baccani, *Oroscopi greci: documentazione papirologica* (Messina: Sicania, 1992); T. de Jong and K. A. Worp, ‘A Greek Horoscope from 373 AD.’ *ZPE* 106 (1995): 235–40; and T. de Jong and K. A. Worp, ‘More Greek Horoscopes from Kellis (Dakhleh Oasis),’ *ZPE* 137 (2001): 203–14. Some of these charts are quite fragmentary. I also include a newly-discovered chart (in February 2009, by Alexander Jones) which contains the calculations of all seven ‘Hermetic’ lots.

6 I have also included one Demotic (Egyptian) chart and one chart of Dorotheus which, though extant only in the Arabic translation, can be supposed to have originally been in Greek. Both are included because they *may* include the Lot of Fortune.

7 Two charts, both in *GH*, nos 95 and 137, also calculate lots. No. 95 mentions three *klēroi*, one of which is called ‘Agathos Daimon’ and another ‘concerning death’, yet I am not convinced that these refer to lots as we know them *per se*, but may refer to places from the Ascendant as ‘allotments’ of different facets of life (perhaps there is a connection with Demotic *tnyt*, ‘part’, used of places in Ostracon 3, ll. 14–18, 20 [in Neugebauer, ‘Demotic Horoscopes’, 116–17]). No. 137 claims to calculate two different lots of Fortune, yet neither conforms to a recognised formula. Again, these may refer to places, the 2nd and the 8th, rather than lots (the ‘lots’ fall in Capricorn and Cancer, the 2nd and 8th places respectively). Also in Ostracon 3, ll. 13 and 19 (116–17), we find the 2nd and 8th places called ‘the provision of life’ and ‘the provision of

1 The Lots and their Luminaries

The lots are calculated using the positions of the luminaries, the Sun and the Moon. The Moon is associated with the body, and the Sun with the mind, the soul and spirit. By a certain amount of assimilation, the two lots also gain these associations. The Moon is traditionally the boundary between heaven and earth—the ‘sublunary sphere’ as opposed to the celestial home of the gods. Daimons are also associated with the Moon, e.g. in Plutarch, where they are said to live on the Moon,⁹ the better to keep an eye on the affairs of humans. The Moon is also the traditional planet associated with Fortune, as it is a literal representation of the changeability of life with its cycles of waxing and waning. Firmicus says of the Moon: ‘... enduring in the manifold variety of her course ... she procreates all the bodies and conceptions of living things and dissolves them when they have been generated.’¹⁰ Valens writes: ‘For cosmically the Moon is fortune and body and breath, and since she is close to the earth and sends her effluence into us, she brings about something similar as she has authority over our body.’¹¹

The Sun, on the other hand, is connected to the Daimon, in that it is metaphorically associated with mind and spirit. As Valens says, ‘the all-seeing Sun, being fiery and a light of the mind, instrument of the soul’s sense-perception, signifies ... intelligence, practical and intentional mind ...’¹² And, he adds, ‘The Sun, which is cosmically mind and daimon on account of his own activity and lovely nature, stirring up human souls for undertakings, is established as a cause of action and movement.’¹³

death; something similar may be occurring here. I have not included these in the list in my article cited at n. 8.

8 D. G. Greenbaum, ‘The Lots of Fortune and Daemon in Extant Charts from Antiquity (First Century BCE to Seventh Century CE)’, *MHNH* 8 (2008): 173–90.

9 Cf. *De facie quae in orbe lunae apparet*, 944c-d. Cf. above, Chapter 1, 1.2, 21; 1.4., 26.

10 *Mathesis*, IV, 1.6 (KSZ, I, 198.17, 21–23 = Monat, II, 129–30): ... cursus sui multiplici varietate sustentans ... omnia animantium corpora et concepta procreat et generata dissolvit.

11 Valens IV, 4.2 (Pingree, 151.26–28): κοσμικῶς γὰρ ἡ Σελήνη τύχη ὑπάρχουσα καὶ σῶμα καὶ πνεῦμα, περίγειος οὖσα καὶ τὴν ἀπόρροιαν εἰς ἡμᾶς πέμπουσα, τὸ ὅμοιον ἀποτελεῖ κυρία οὖσα τοῦ καθ’ ἡμᾶς σώματος: ...

12 Valens I, 1.1 (Pingree, 1.1–3): <O> μὲν οὖν παντεπόπτῆς Ἡλῖος πυρώδης ὑπάρχων καὶ φῶς νοερόν, ψυχικῆς αἰσθησεως ὄργανον, σημαίνει ... νοῦν, φρόνησιν: ...

13 Valens IV, 4.2 (Pingree, 151.28–31): ὁ δὲ Ἡλῖος νοῦς καὶ δαίμων κοσμικῶς ὑπάρχων διὰ τῆς ἰδίας ἐνεργείας καὶ φύσεως ἐρασμίον, τὰς τῶν ἀνθρώπων ψυχὰς διεγείρων περὶ τὰς ἐγχειρήσεις, αἴτιος πράξεως καὶ κινήσεως καθίσταται.

Correlations between the Moon and the Lot of Fortune, and the Sun and the Lot of Daimon are shown in the following table:

TABLE 9.1 *Attributions of the Sun/Lot of Daimon and the Moon/Lot of Fortune*¹⁴

Sun	Lot of Daimon	Moon	Lot of Fortune
breath	soul	body	human bodies
soul	intentional mind	mother	actions in life
movement	character	conception	sufferings of soul
mind	power	fortune	companionship
light of the mind	worth	breath	reputation
intentional mind	reputation	an eye	fortune
spirit (<i>daimôn</i>)	religious rites	<i>pronoia</i>	bodily passions
action	intended plans		acquisitions
vision, an eye	advice		
oracular response	mental activity		
of gods	action		
soul's sense- perception			

The Sun and Moon were considered the most significant bodies in astrological interpretation. They receive this importance from their astronomical prominence, their clear causal connections to life on earth and particularly, I suspect, from the light they provide. (Their importance in Egyptian and Babylonian cosmology, which influenced the doctrines and principles of Hellenistic astrology, also should not be discounted.) Even though they are treated as 'planets' in astrology,¹⁵ they are also set apart from the other five visible planets—at least partially—because of the light they give. Note that in Plato's planetary scheme in the Myth of Er (*Republic* x.616c–617d), the sphere of the Sun is the 'brightest' and that of the Moon 'reflected light'. In the planetary listings for both the

14 Attributions drawn from Vettius Valens (I, 1; II, 20; IV, 4 and 25; IX, 2), Antiochus (*CCAG* I, 160; *CCAG* VII, 127), Paulus (ch. 23); Olympiodorus (ch. 22); Rhetorius (ch. 54, *CCAG* VIII/4, 122.20–23).

15 In that they 'wander' as the other planets do, unlike the 'fixed stars' which move only extremely slowly (approximately 1° every 72 years) against the backdrop of the ecliptic.

non-literary and literary extant Greek charts, the luminaries are usually listed together, before or after the other planets.¹⁶ Demotic charts also seem to follow these kinds of arrangements.¹⁷ Babylonian charts usually list the Moon first and the Sun next, before the rest of the planets.¹⁸

The fact that the Lots of Fortune and Daimon are aligned with and formed from the luminaries may help account for their importance and in turn emphasise the importance of the luminaries. In Valens, the lots are used both in elaborate time-lord systems and in the predictive technique known as profections. (We shall survey these systems later in this chapter.) In Manilius and in Valens, the Lot of Fortune and places from it have much interpretive significance. In Paulus Alexandrinus and Olympiodorus, his commentator, Fortune and Daimon are listed first in the chapters on lots; indeed, Olympiodorus points out that they are crucial to the creation of the other planetary lots.

2 Calculating the Lots of Fortune and Daimon

In the formulae for the Lots of Fortune and Daimon, we know that, except for Ptolemy, virtually all Hellenistic astrologers take the sect of the chart into account. For the Lot of Fortune, they take the arc from Sun to Moon in a diurnal chart, and the arc from Moon to Sun in a nocturnal one, and project this arc from the Ascendant to find the position of the lot.¹⁹ We can state this mathematically as:

$$\text{Asc} + \text{Moon} - \text{Sun} \text{ (D)} \quad \text{or} \quad \text{Asc} + \text{Sun} - \text{Moon} \text{ (N)}$$

16 GH, 164.

17 Ross, 'Horoscopic Ostraca from Medīnet Mādi', 24–25.

18 The Babylonian Moon god was considered to be of primary importance, which is probably why the Moon is listed first. The extant chart listings can be found in Rochberg, *Babylonian Horoscopes*. While there is no reason to believe that the order will change in charts discovered in the future, it is likely that more Babylonian horoscopes will be discovered, considering the large amount of unpublished and only partially catalogued cuneiform tablets. For example, Francesca Rochberg has told me (personal communication, 7 May 2007) of a newly-found duplicate of Text 9, the horoscope of Anu-bēlšunu, in *Babylonian Horoscopes*, 79–81.

19 For a discussion of one extant chart which seems not to do this, see D. G. Greenbaum, 'Calculating the Lots of Fortune and Daemon in Hellenistic Astrology', *Culture and Cosmos* 11 (2007): 163–87, esp. 173–84.

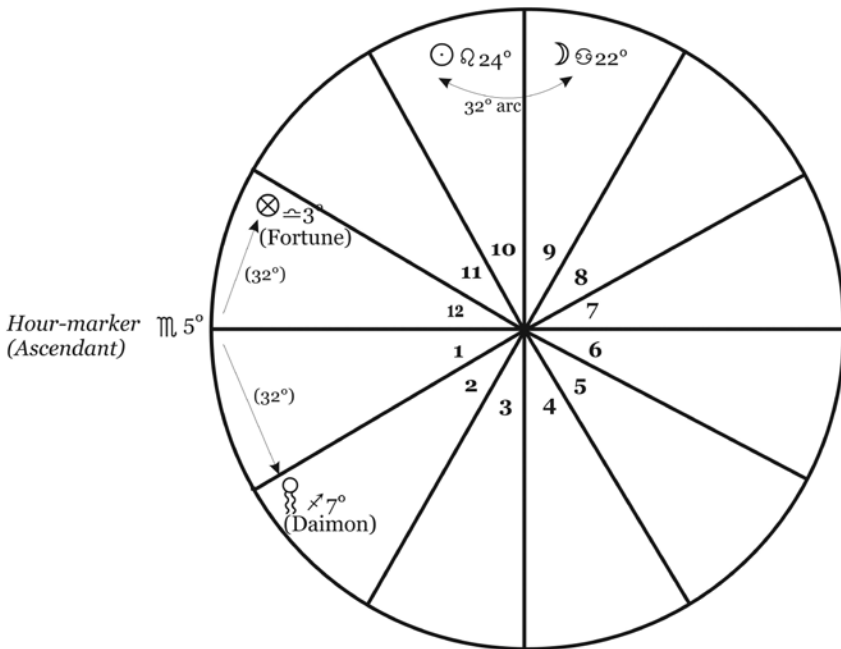

FIGURE 9.1 *The Lots of Fortune and Daimon in a diurnal chart.*

The arc is determined from the sect luminary—the Sun by day and the Moon by night. For the Lot of Daimon, the formula reverses:

$$\text{Asc} + \text{Sun} - \text{Moon (D)} \quad \text{or} \quad \text{Asc} + \text{Moon} - \text{Sun (N)}$$

Through the incorporation of the sect requirement in the formula, the relationship between the lots is visually seen, as they become mirror images of each other. In addition, they are linked mathematically via their equal proportion from the Ascendant. The Lot of Fortune is called the ‘archetypal’ lot in Valens and Serapion,²⁰ while the Lot of Daimon is the ‘second’ lot.²¹ In Olympiodorus’s *Commentary on Paulus*, recall (Chapter Eight, 2.2, 297–98) that he says, referring to the Lots of Fortune and Daimon, ‘Especially concerning these things, the greatest power of divination abides with knowing the

20 Valens, II, 13.1 (Pingree, 65.5):... τὸν ἀρχέτυπον κλήρον... Serapion: *CCAG* VIII/4, 227.17: Ἀρχέτυπος λέγεται ὁ καλούμενος κλήρος τύχης...

21 Valens, II, 15.9 (Pingree, 66.30–31):... τοῦ δευτέρου κλήρου... (ὅς προσαγορεύεται δαίμων)...

characteristics of the soul and instruction about the body. . . . one must seek the Lot of Daimon and Fortune before all the [other] lots.²²

3 Variation on a Theme: The Lot of Basis

Another lot has a strong affiliation with the Lots of Fortune and Daimon. This is the Lot of Basis, or Foundation, used in the ‘Investigation of Chart Factors’ (Ἐπίσκεψις πινακικῆ) of Rhetorius,²³ in Antiochus/Rhetorius (Paulus)²⁴ and by Firmicus Maternus.²⁵ Vettius Valens gives the most thorough treatment. Its kinship can be seen immediately by its formula, which uses the lots of both Fortune and Daimon in its calculation. The formula is given in Valens, 11, 23, in a rather difficult passage, unfortunately:

... and likewise from the Lot of Basis (which is found from Fortune to Daimon and from Daimon to Fortune, and the equal amount from the Hour-marker; yet it will not carry over the seventh number for both night and day [nativities], but one must cast out from the nearer lot to the other lot)...²⁶

22 Olympiodorus, ch. 22 (Boer, 46.16–47.2; 47.5–6): ... περὶ ταῦτα δὲ μάλιστα ἡ μεγίστη μαντεία καταγίνεται τοῦ γνῶναι ἤθη ψυχῆς καὶ διαγωγὴν σώματος. . . . πρὸ πάντων τῶν κλήρων τὸν τοῦ Δαίμονος καὶ τῆς Τύχης κλήρον ζητητέον.

23 Rhetorius 54 (Pingree, 39.5–6 = CCAG VIII/4, 120.27–28): ... δεῖον ζητεῖν τὸν κλήρον τῆς τύχης καὶ τοῦ δαίμονος καὶ τῆς βάσεως. . . (See Appendix 8.C.)

24 In CCAG I, 160.16–18. See full quotation in n. 30.

25 Firmicus, *Mathesis*, VI, 32.56.

26 11, 23.7 (Pingree, 84.2–6): ... ὁμοίως δὲ καὶ τὸν κλήρον τῆς βάσεως (ὅς εὑρίσκεται ἀπὸ τύχης ἐπὶ δαίμονα καὶ ἀπὸ δαίμονος ἐπὶ τύχην, καὶ τὰ ἴσα ἀπὸ ὠροσκόπου· τὸν μέντοι ἑβδομαδικὸν ἀριθμὸν οὐχ ὑπερῆσει ἐπὶ τε τῶν νυκτὸς καὶ ἡμέρας, ἀλλὰ ἀπὸ τοῦ ἐγγίονος κλήρου ἐπὶ τὸν ἔτερον κλήρον δεῖ λαμβάνειν). . . . Neugebauer and Van Hoesen, *GH*, 9, think the formula is a straightforward reversal of Fortune and Daimon by night and day. Some other Hellenistic authors use this formula (e.g., Olympiodorus, ch. 22, Boer, 58.21 and 60.3–5; Firmicus, VI, 32.56), but Valens clearly qualifies the first statement he makes about it, and those qualifiers cannot be dismissed. (The passage is the same, save for some parentheses, in both the Kroll and Pingree editions of Valens.)

The meaning seems to be that one uses the shorter arc between Fortune and Daimon,²⁷ but projects always in zodiacal order from the Ascendant.²⁸ Using the shorter arc will ensure that the Lot of Basis will always fall below the horizon, which makes symbolic sense as it is the lot of foundations (the fourth place, at the bottom of the chart, is also known as a foundation).²⁹ As for what the lot shows, Antiochus (Paulus)/Rhetorius says ‘The Hour-marker’s Lot—the Lot of Basis—is established as responsible for life and breath; for Basis itself is the giver of breath for the *Hōroskopos*, and signifies bodily things and living abroad.’³⁰ It is perhaps significant that this Lot is tied to the Hour-marker and underlies its expression.

The Lot of Basis, bound, so to speak, with the Lots of Fortune and Daimon, is delineated with them as indicative of fame and fortune in Valens (see examples below). The Lot of Basis is also related by its formula to two other lots as Valens calculates them, those of Eros and Necessity. The position of Basis will be identical to one or the other of them.

4 The Lots in Interpretation: Descriptions

In the *Carmen Astrologicum*, Dorotheus devotes 1, 26 to the Lot of Fortune and its interpretation. The previous few chapters dealt with the effect of the Sun and Moon, and their triplicity lords, on fortune; this chapter is the capstone

27 ‘Carry over the seventh number’ must refer to an arc larger than 180 degrees. I follow the analysis of Robert Hand, Vettius Valens, *Anthology Book 11, Part 1*, trans. Robert Schmidt, Robert Hand ed. (Berkeley Springs, WV: Golden Hind Press, 1994), 43, n. 1.

28 With other lots that reverse the positions in the formula, the arc always goes in zodiacal order, but the reversal creates a shorter arc in one instance and a longer arc in the other. Different positions are obtained by projecting each arc in zodiacal order from the Ascendant. (Geometrically, one can take the shorter arc in all cases, but project from the Ascendant in different directions; but this is not the way Hellenistic astrologers explain it, though there may be an instance of the implicit application of this procedure in Valens IX, 2.5, 7: see below, Section 7.)

29 See Paulus (Boer, 56.5), Olympiodorus (Boer, 65.15), Dorotheus (Pingree, 382.4–5), Rhetorius, *CCAG VIII/4*, 148.26–149.1 (the word used is θεμέλιον, which LSJ, s.v., translates as ‘foundation’). Yet in Paulus (Boer, 49.15–16) and Olympiodorus (Boer, 56.22–23), the Hour-marker is also called ‘basis’, the base or foundation of the chart. Perhaps there is a connection here between the beginning of life (the Hour-marker) and its end (the fourth); both places are thus ‘foundational’.

30 Antiochus (Paulus)/Rhetorius, *CCAG I*, 160.16–18: ὠροσκόπου ὁ κλήρος τῆς βάσεως ζωῆς καὶ πνεύματος παραίτιος καθέστηκεν· αὐτὴ γὰρ ἢ βασις πνεύματός ἐστι δοτικὴ τοῦ ὠροσκόπου καὶ τὰ σωματικὰ καὶ τὰς ξενιτείας σημαίνει.

on how to find fortune in a nativity. Dorotheus tells us to look at the Lot if the lords of the luminaries are in bad condition. His method of interpretation is the usual one: look at where the lot falls, its aspects from benefic or malefic planets, and the lord of the lot and its condition. The best indication of fortune and property, he says, is if the lord of the Lot of Fortune is dignified, either by house, triplicity, exaltation or bound. He does not give any charts as examples in this chapter. In I, 24 (on fortune and property in the nativity), Dorotheus presents one chart which mentions the 'fortune' (Pingree, 185). This probably means the eleventh place, although it could refer to the Lot of Fortune because the chart is diurnal, and using a diurnal formula the Lot would fall where he says 'fortune' is located (see discussion in Chapter Two, 2.4 and Fig. 2.2).³¹

Antiochus of Athens gives only descriptions, not examples, of the effects of the Lots of Fortune and Daimon (See Appendix 8.B). These appear in Chapter 48 of his *Thesaurus*. The effects often have to do with banishment, injury or violent death. Only one condition is fortunate: 'When Zeus is beholding the Lot of Daimon, it makes such a one receive divine revelation from gods and dreams and will have all divine favours, even if [Zeus beholds it] by square or opposition.'³² In the circumstances when malefics aspect the lots, madness results; and when they are with the new or full moon and oppose the lords of the lots, 'braggarts and insolent people.'³³

Firmicus considers sect in his formulae for the Lots of Fortune and Daimon, and is careful to give instructions on calculating the lots either by sign (*platice*) or by degree (*partiliter*). (For a complete translation of Firmicus on this subject, see Appendix 9.A). In each of his lot descriptions, we can see how they are linked together in his mind:

[The Lot of Fortune] <5.> From this place [where the Lot of Fortune is] is said to be shown the quality of life, the father's estate, and the course of both happiness and unhappiness. The quality of love, also, and the affections of husbands toward wives is learnt from this place. Sought from the

31 From the positions of the Sun and Moon, the Lot of Fortune would fall in the eleventh place in a diurnal chart as this one is; but the reference could equally be to the eleventh as a 'place of fortune' (The Arabic version of Dorotheus describes the 11th that way in v, 17.2 [Pingree, 275]: 'If you find the Sun... in the house of good fortune [the eleventh]...! (But a Greek parallel uses ἐν τῷ ια' instead of 'good fortune' [Dorotheus v, 17 ap. Hephaestio, III, 11.2, Pingree, 394.2].)

32 CCAG I, 161.2–5: Ζεὺς θεωρῶν τὸν κλῆρον τοῦ δαίμονος ποιεῖ τὸν τοιοῦτον ὑπὸ θεῶν καὶ ἐνυπνίων χρηματισθῆναι καὶ πάντα τὰ θεῖα εὐμενῆ ἔξει, κὰν τετραγωνῆ κὰν διαμετρῆ.

33 CCAG VII, 113.2:... πανσελήνων <ῆ> συνόδων, ἡνίκα ὁ κύριος τοῦ κλήρου τοῦ δαίμονος ἐναντιούμενος <ῆ> αὐτῷ, ποιεῖ ἀλαζόνας καὶ ὕβριστάς.

substance of this particular place, as well, is the effect of nourishment and all desires. This place or the lateral squares of this place³⁴ denotes, with easy reckoning, the fatherland. Moreover it is called, as Abraham defines it, the place of the Moon. <6.> See, therefore, who is the lord of the entire sign, and the lord of the particular degree, that is, in the bounds of what star that degree is and in what place both the lord of the sign as well as the degree, namely the degree in which the place of Fortune was found, and in what places of the geniture they have been set—whether in the foremost places, that is, the cardines; or in secondary places; or in cadent ones; or whether they are in their own heights [*i.e. exaltations*] or domiciles or falls. And also whether the lord of the sign itself, from the place it is in, regards its sign, that is, the place of Fortune, with suitable rays; and if the lord of the lot itself, that is, if the lord of the bounds in which the place of Fortune is found, regards its own lot from the place it is in with suitable rays; and if both have been joined to each other in a cardine.³⁵

[The Lot of Daemon] This place is also called the substance (*substantia*) of the soul; from this place we seek actions and increases of all substance. It shows what sort of affection there is of a wife toward her husband. But this place and its lateral squares denote with clear reckoning the fatherland to us. See, therefore, what malefic and what benefic stars

34 'Lateral squares of this place' omitted by Ksz, but perhaps this refers to angles from the Lot.

35 Julius Firmicus Maternus, *Mathesis*, IV.17.5–6 (Ksz, I, 239.13–240.6 = Monat, II, 174–75): '<5.> Ex hoc loco qualitatem vitae et patrimonii substantiam et felicitatis atque infelicitatis cursus ostendi datur. Amor etiam et adfectus virorum circa mulieres qualis sit, ex hoc loco discitur et nutrimentorum et desideriorum omnium effectus ex istius loci substantia quaeritur. Hic locus patriam [vel huius loci quadrata latera] facili ratione demonstrat. Appellatur autem, sicut Abraham designat, Lunae locus. <6.> Vide ergo dominum totius signi, qui est, et dominum partis istius, id est in cuius stellae finibus ista pars sit et quo in loco sit uterque dominus signi pariter et partis, eius scilicet partis, in qua locus Fortunae fuerit inventus, et in quibus geniturae locis sint constituti, an in principalibus, id est in cardinibus aut in secundis locis, an <in> deiectis, an in altitudinibus suis an in domibus an in deiectionibus; et an dominus ipsius signi [et] ex eo loco, in quo est, signum ipsius, id est locum Fortunae oportunis radiationibus respicit; et si dominus partis ipsius, id est si dominus finium, in quibus locus Fortunae fuerit inventus, ipsam partem ex eo loco, in quo est, oportunis radiationibus respicit; et si sint ambo invicem sibi cardinaliter iuncti.'

[i.e. *planets*] regard this place, and thus explain the outcomes by the testimonies of individual stars.³⁶

Firmicus contrasts the food (nourishment) and desire³⁷ that Fortune represents with the action and increase of Daimon, and associates both lots with affection and the fatherland (the 'lateral squares' would be equivalent to the fourth and tenth places). Interestingly, he uses the word *substantia* in connection with *both* lots.

Finally, there is a rather strange melothesia in Valens II, 37, in which he describes the assignment of body parts to the Lots of Fortune and Daimon.³⁸ (See Appendix 9.B.) The assignments from the Lot of Fortune start from the breast, and seem to connect to Cancer; while those from the Lot of Daimon start from the heart, associated with Leo. This is because, Valens says, the 'Moon is the Fortune of the cosmos, and the Sun is mind and Daimon.'³⁹ Wolfgang Hübner has noticed that the outer parts of the body are assigned to the Lot of Fortune, and the inner parts to the Lot of Daimon.⁴⁰ The Moon and Fortune represent what can be seen from the outside, but the Sun and Daimon that which is hidden, on the inside.⁴¹ Valens attributes this system to the 'ancients' but adds that his experience has allowed him also to show what

36 Ibid., IV.18.2 (KSZ, I, 242.21–28 = Monat, II, 178): 'Hic locus vocatur et animae substantia; ex hoc loco actus omnisque augmenta substantiae quaerimus [invenimus], et ostendit, qualis circa virum mulieris sit adfectus. Sed et hic locus et quadrata latera ipsius loci patriam nobis manifesta ratione demonstrat. Vide ergo, locum hunc quae malivolae stellae, quae benevolae respiciant, et sic apotelesmata pro singularum stellarum testimoniis explica.'

37 My thanks to Guido Giglioli for pointing out the close connection between desires and food in ancient culture: among the Greeks, they are said to be associated with the same area of the body, i.e. the abdomen (stomach and liver).

38 An Italian translation of this section is in Bezza, *AM*, vol. 2, 731–39, along with Valens' list of zodiacal assignments on 722–31.

39 Valens, II, 37.5 (Pingree, 104.11–12): ... ἡ μὲν Σελήνη τύχη τοῦ κόσμου ἐστίν, ὁ δὲ ἥλιος νοῦς καὶ δαίμων. For a repetition of Σελήνη τύχη τοῦ κόσμου, cf. IX, 2.2 (Pingree, 318.23–24).

40 W. Hübner, 'Eine unbeachtete zodiakale Melothesie bei Vettius Valens', *RhM* 120, no. 3 & 4 (1977): 247–54, here 249. Hübner also points out, 248, that Antiochus, *CCAG* VIII/3, 113.8–13, assigns the outer parts of the body to the zodiac signs, but the inner parts to the planets.

41 This might be a clue about the reason why, in Arabic astrology, the Lot of Daimon is called the 'pars absentiae' or 'pars celati' (part of the absent or the hidden). (E.g., Al-Qabiṣī, *Introduction*, v, 4 [Burnett/Yamamoto/Yano, eds, 141], 'lot of the absent'; John of Seville's translation of Abū Ma'shar's *Greater Introduction* (Lemay, vol. v), VIII.333–334, says the lot signifies 'res occultas et celatas'.) In a new edition, Abū Ma'shar, *Abū Ma'shar: Great*

and how injuries and diseases manifest from each of these. Fortune, he says, brings about injuries (determined from its sign), while Daimon (and its sign) brings about diseases. Eleven charts illustrate these principles. Antiochus may have drawn on a similar doctrine when he gave his descriptions of injury and illness from the Lots of Fortune and Daimon.⁴²

Why are injuries ascribed to the Lot of Fortune, while illnesses are the province of the Lot of Daimon? It may be because an injury usually has an identifiable cause outside oneself. It is an obvious assault on the body. An illness, however, is not so easily assigned a physical cause, although the role of external factors in affecting a person's health was recognised in antiquity (e.g. the six non-naturals);⁴³ the prevailing Hippocratic and Galenic tradition would say it was an imbalance of humours. In addition, diseases, both mental and physical, were sometimes seen as being caused by evil daimons (as we have seen). Both physical and mental illness are assigned to the Lot of Daimon. These lots, joining Sun, Moon and Ascendant, become a potent force for affecting body and mind.

5 The Lots in Interpretation: Case Studies

Some case studies will illustrate the use of the lots in practice. We shall begin with the only currently known Demotic chart which may list the Lot of Fortune.

5.1 Case Study Number One: A Demotic Chart with the Lot of Fortune?

The work on Demotic charts is far from done.⁴⁴ Within the present corpus, there is one chart which appears to mention the Lot of Fortune. It was found

Introduction to Astrology, ed. Keiji Yamamoto, trans. and comm. Keiji Yamamoto and Charles Burnett, (Leiden/Boston: Brill, forthcoming), see VIII, 3.10.

42 *Introduction*, CCAG VIII/3, 113.8–13; melothesia from Lots of Fortune and Daimon also in *Thesaurus*, 14, CCAG I, 152 (= Porphyry, *Intr. Tetr.*, 50, CCAG V/4, 223.1–9).

43 See L. García-Ballester, 'On the origin of the "six non-natural things" in Galen', in *Galen and Galenism: Theory and Medical Practice from Antiquity to the European Renaissance*, ed. Jon Arrizabalaga, et al. (Aldershot: Ashgate, 2002), IV.105–15, and his bibliography.

44 Much remains unpublished on the horoscopic ostraca from Medīnet Mādi. Previous publications of Demotic charts include Neugebauer, 'Demotic Horoscopes'; O. Neugebauer and R. A. Parker, 'Two Demotic Horoscopes', *JEA* 54 (1968): 231–35; R. A. Parker, 'A horoscopic text in triplicate', in *Grammata demotika: Festschrift für Erich Lüdeckens zum 15. Juni 1983*, ed. H.-J. Thissen and Karl-Th. Zauzich (Würzburg: Gisela Zauzich, 1984), 141–43; Spiegelberg, 'Namen und Zeichen'; Thompson, 'Demotic Horoscopes'; Quack, 'Ein

on an ostracon from Medînet Mâdi.⁴⁵ This ostracon, OMM 134, contains two charts in list form, divided by a horizontal line, plus a third section, separated by rectangular lines, which appears to go with the second chart. For our purposes, the relevant lines are 7–14:

<i>Transliteration:</i> ⁴⁶	<i>Translation:</i>	
7 <i>Hr-p³-K³: 3h.t. ꜥh: 3h.t.</i>	Saturn: Libra	Moon: Libra
8 <i>Hr-p³-Št: M3i. R^c-H^c: Htr.</i>	Jupiter: Leo	Ascendant: Gemini
9 <i>Ntr.t: 3h.t</i>	Venus: Libra	
10 <i>Swg³: M3i.</i>	Mercury: Leo	
11 <i>R ꜥ, [Hr-p³-Tš]: Rpi</i>	Sun, [Mars]: Virgo	
12 <i>Sr: t3 R^c.</i>	Aries: the Lot	
13 <i>.t Šy</i>	[of] Fortune	
14 (<i>fate determinative</i>)	(<i>fate determinative</i>)	

This chart is tentatively dated to 4 September 129 CE, at about 10:30 p.m.⁴⁷ This time gives an Ascendant in early Gemini. The chart is nocturnal, and if the signs Ross has interpreted as being the Lot of Fortune are correct, the lot falls in late degrees of Aries, which fits with the nocturnal formula:

$$\text{Fortune (N)} = \text{ASC} + \text{Sun} - \text{Moon}$$

I offer an alternative translation for lines 13 and 14. The translation of line 13, instead of ‘Fortune’, might be ‘Shai’. This alternative seems plausible because another Demotic chart on an Egyptian ostracon lists the names of the astrological places, and the eleventh place is called ‘the Shai’,⁴⁸ which fits well considering that the Egyptian equivalent of the Agathos Daimon is the god Shai.

astrologisches Ostrakon’. See also Ross’s bibliography, ‘Horoscopic Ostraca from Medînet Mâdi’, 3–7; Quack’s bibliography, ‘Dekane’, 2.1.14 (2.2.14 2014).

45 I am grateful to Micah Ross for alerting me to this chart, which he has analysed in ‘Horoscopic Ostraca from Medînet Mâdi’, 109–17; also M. Ross, ‘A Provisional Conclusion to the Horoscopic Ostraca from Medînet Mâdi’, *EVO* 34 (2011): 47–80, here 56–62.

46 I am using Ross’s transliteration and translation, ‘Horoscopic Ostraca’, 110.

47 Ross and I have agreed that this date and time accords best with the planetary positions listed on the ostracon. Modern values, based on a time of 10:30 p.m. LMT, 4 Sep 129 CE, Abu Jandir, Egypt (2 km from Medînet Mâdi) are: Asc $\text{II}4^{\circ}09'$; $\odot\text{II}10^{\circ}38'$; $\text{♁}18^{\circ}34'$; $\text{♃}26^{\circ}02'$; $\text{♂}14^{\circ}36'$; $\text{♄}23^{\circ}23'$; $\text{♀}17^{\circ}33'$; $\text{♁}22^{\circ}53'$; Lot (of Fortune) $\text{♈}26^{\circ}13'$. (The calculation program was Solar Fire v. 5.1.)

48 Neugebauer, ‘Demotic Horoscopes’, 116–17 (line 22 of Ostracon 3). (See discussion in Chapter 2, 2.2, 54–55.)

Note that this is only an hypothesis at this point, based on the following assumptions: the date of the chart as 129 CE, the identification of Aries with both the place and the lot and finally, the computation of the lot by degree, not just by sign.⁵¹

5.2 Case Study Number Two: Places from the Lot of Fortune

In keeping with their status as the premier lots, Vettius Valens sets out elaborate predictive techniques using the Lots of Fortune and Daimon in Books II and IV of the *Anthology*, with examples. Chapters in Book II focus on the lots in relation to happiness (*eudaimonia*, literally ‘having a good daimon’), and introduce the idea of using the Lot of Fortune as an Ascendant (ὥροσκόπος: ‘Hour-marker’).

We have seen (Chapter Eight) the Lot of Fortune used as an Hour-marker in Manilius’s ‘Circle of Athla’ (3.96–168), and the ‘lot’ places’ possible connections to liver divination and katarthic astrology. Valens, too, creates a system of places from lots, describing those from the Lot of Fortune in some detail (II, 18, 20, 21). In both Manilius and Valens, the eleventh place from Fortune is seen as particularly beneficial (is this because it is analogous to the place of the Good Daimon?). Valens emphasises that the Lot of Fortune is equal in power to the Hour-marker (Ascendant).⁵² He also quotes an interesting passage which he does not specifically ascribe to anyone:⁵³

... from which they prognosticate in their works, saying: ‘in varying figures when the Lot is allotted the authority of the centrepins, neither the tropical, nor solid, nor bi-corporeal [signs] will possess the same power throughout. And so one must also look at the stars which are witnessing or co-present in relation to the lot, so that if a benefic is in this [place where the lot is], or witnessing it, it becomes predictive of good things and a giver of possessions. But if a causer of destruction [*i.e. a malefic*], it

the synastry between marriage partners in Book III, chapters 9 and 10, he makes several references to just ‘the lot’ (Pingree, 262–63, 265), and obviously means the Lot of Fortune.

51 Micah Ross and I have discussed these possibilities, personal communications, 24–30 April and 20–22 May 2007.

52 See especially II, 18.5 (Pingree, 76.13–18), where he equates the Lot with the Hour-marker, and its squares and oppositions with the Midheaven, Underground and Setting places.

53 Kroll, the previous editor of Valens, suggests ‘they’ are Nechepso and Petosiris (Vettius Valens, *Anthologiarum libri*, ed. Wilhelm Kroll, (Berlin: Weidmann, 1908), 79, *app. crit.*, line 27 (Book II, 17): ‘Nechepso et Petosiris, ut opinor’). Riess does not include it in his fragments of Nechepso and Petosiris published in 1892. The use of the word μυστικῶς in the previous sentence, though, might well obliquely refer to Nechepso and Petosiris.

will become a cause of a loss of possessions and of the body wasting away.’⁵⁴

So the Lot of Fortune is specifically given the same authority and effective power as the centrepins formed from the Ascendant (the Lots of Fortune, Daimon, Eros and Necessity are given like power in Book IV, 11). Valens gives six examples of this technique.⁵⁵ This is L82 in *Greek Horoscopes*, dated 9 July 82 CE, about noon.

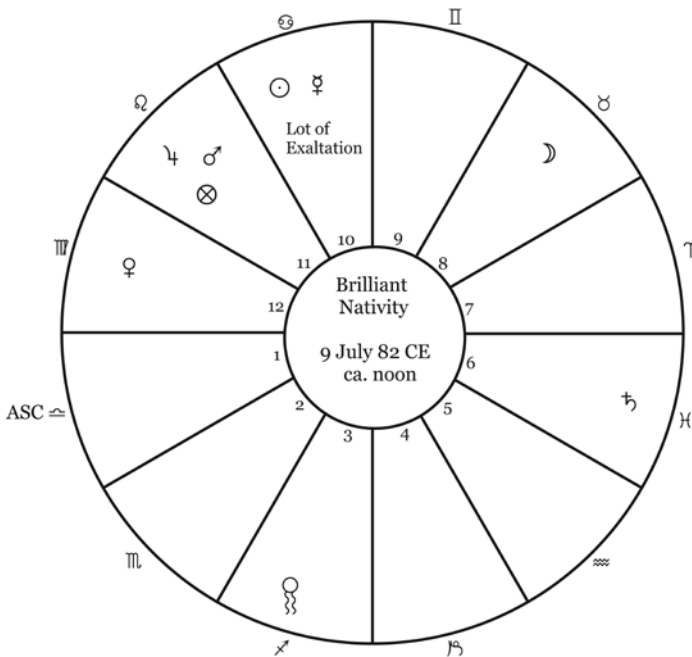

FIGURE 9.3 Chart using places from the Lot of Fortune.

- 54 Valens, II, 18.7–8 (Pingree, 76.20–27): ὅθεν καὶ ἐν τοῖς συντάγμασι προδηλοῦσι λέγοντες· ἐν δὲ ἑτεροτρόποις σχήμασι τῶν κέντρων τοῦ κλήρου τὴν δυναστείαν λαχόντος, καὶ οὔτε μὴν διὰ παντός τὰ τροπικὰ οὔτε τὰ στερεὰ οὔτε τὰ δίσιμα τὴν αὐτὴν δύναμιν ἐφέξει. δεῖ οὖν καὶ τὰς μαρτυρίας τῶν ἀστέρων ἢ συμπαρουσίας θεωρεῖν τὰς πρὸς τὸν κλήρον ἴν' εἰ μὲν ἀγαθοποιὸς ἐπὶ τούτῳ ἐπέιη ἢ καὶ τῷδε μαρτυρήσῃ, προδηλωτικὸς ἀγαθῶν καὶ δοτὴρ ὑπαρχόντων γένηται· εἰ δὲ φθοροποιός, ἀποβολῆς ὑπαρχόντων καὶ φθίσεως σώματος αἴτιος γενήσεται.
- 55 Other examples delineating the *uth* place from Fortune as a place of acquisition (all in II, 22) are sentences 2–9 (= L50 in *GH*); 17–20 (= L83); 36–37 (= L65,X); 38–39 (= L105); and 40–42 (= L61,V).

Another. Sun, Hermes in Cancer; Moon in Taurus; Kronos in Pisces; Zeus, Ares in Leo; Aphrodite in Virgo; Hour-marker in Libra. This nativity became brilliant and remarkable; for he was entrusted with royal offices and deemed worthy of a high priesthood. For the lord of the triplicity was found with the lord of the [Lot of] Daimon, in the place of the Good Daimon and with the Lot of Fortune, and the Sun, culminating, was allotted the Lot, and the lady of the exaltation, the Moon, was culminating with respect to the Lot. But the acquisition was irregular and unstable, sometimes quite abundant, sometimes insufficient; for Kronos and Aphrodite witnessed the place.⁵⁶

The positions of Fortune and Daimon are not given, but Fortune is in Leo, and Daimon is in Sagittarius. These accord with the daytime formulae. The lord of Fortune is the Sun; the lord of Daimon, Jupiter. Jupiter and Mars are found together in the place of the Good Daimon (Valens deems Mars the triplicity lord), and the Lot of Fortune is also there. Fortune's ruler, the Sun, is in the Midheaven with the Lot of Exaltation. Exaltation's lady, the Moon, is in a tenth place position from the Lot of Fortune. All this denotes the brilliance of the nativity. As far as acquisition goes, however, things are not so rosy, because the eleventh place from Fortune, Gemini, is squared by Saturn in Pisces and Venus in Virgo. What the Lots giveth, the Lots taketh away. Valens weaves his interpretation of the lots together to give the picture of the native.

5.3 Case Study Number Three: Places from the Lot of Daimon

In an example in v, 6, Valens uses the Lot of Daimon as an Ascendant in his chart interpretation (this is number L123 in *GH*).

... for the Lot of Fortune was in Aries, but the lord of the exaltation for the nativity, the Sun, was found culminating with respect to the Lot [of Fortune], and Ares [culminating] with respect to the [Lot of] Daimon. ...

56 Valens, II, 22.26–29 (Pingree, 81.16–24): "Ἄλλη. Ἡλῖος, Ἑρμῆς Καρκίνω, Σελήνη Ταύρω, Κρόνος Ἰχθύσιν, Ζεὺς, Ἄρης Λέοντι, Ἀφροδίτη Παρθένω, ὠροσκόπος Ζυγῷ. καὶ αὕτη ἡ γένεσις λαμπρὰ καὶ ἐπίσημος γέγονεν· ἐπιστεύθη γὰρ βασιλείας καὶ ἀρχιερωσύνης κατηξιώθη. εὐρέθη γὰρ ὁ κύριος τοῦ τριγώνου σὺν τῷ κυρίῳ τοῦ δαίμονος ἀγαθοδαιμονῶν καὶ μετὰ τοῦ κλήρου τῆς τύχης, καὶ <ὁ> Ἡλῖος κληρωσάμενος τὴν τύχην μεσουρανῶν, ἡ δὲ τοῦ ὑψώματος κυρία Σελήνη κατὰ τὸν κλήρον μεσουρανοῦσα. ἡ δὲ περιποίησις ἀνώμαλος καὶ ἄστατος, ὅτε μὲν ὑπερπλεονάσασα, ὅτε δὲ ἐνδεής· ἐμαρτύρει γὰρ τῷ τόπῳ Κρόνος καὶ Ἀφροδίτη.

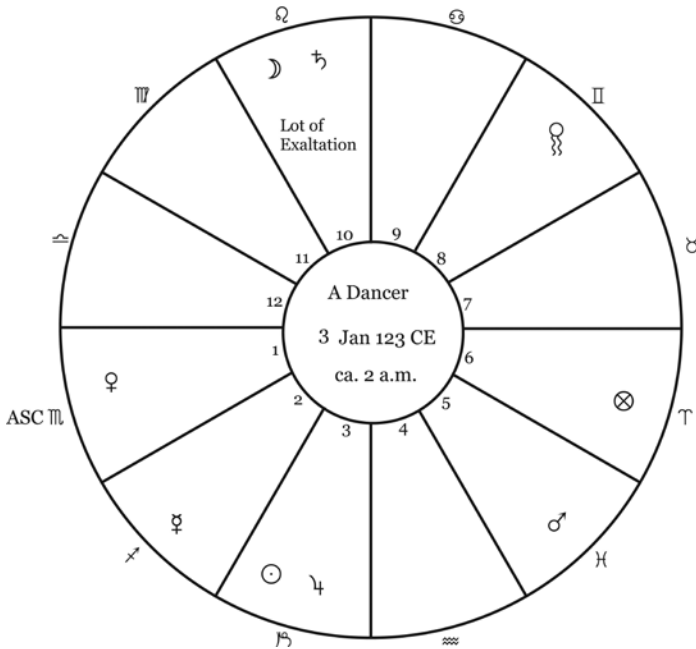

FIGURE 9.4 Chart using places from the Lot of Daimon.

For the lord of the [Lot of] Daimon and the intellectual place, Hermes, was opposed to itself (that is, to Gemini).⁵⁷

It is clear that the ‘Daimon’ referred to here is indeed the Lot of Daimon, and not the eleventh place, because Mars in Pisces is culminating with respect to the Lot of Daimon in Gemini, but does not culminate with respect to the eleventh place. Mercury in Sagittarius rules the Lot of Daimon in Gemini, and indeed opposes the Lot. The ‘intellectual place’ could be interpreted in two ways: where the Lot of Daimon falls is an ‘intellectual place’, or the Good Daimon place is ‘intellectual’ (both places are ruled by Mercury, so we cannot tell which is meant).

But why create, so to speak, a second Hour-marker and set of delineations about its places? The reason for this may be in the particularity and individualisation that the *lots* represent in the chart, versus the universal and general

57 Valens, v, 6.119–125 (Pingree, 219.22–220.11), esp. 6.124–125, (Pingree, 220.3–5, 10–11): ἦν γὰρ ὁ κληρὸς τῆς τύχης Κριῶ, τοῦ δὲ ὑψώματος κατὰ τὴν γένεσιν κύριος ὁ Ἥλιος εὐρέθη μεσουρανῶν κατὰ τὸν κληρὸν καὶ Ἄρης κατὰ τὸν δαίμονα. . . καὶ γὰρ ὁ κύριος τοῦ δαίμονος καὶ τοῦ διανοητικοῦ τόπου Ἑρμῆς ἑαυτῷ ἠγναντιώθη (τουτέστι τοῖς Διδύμοις).

position of the *planets* in the zodiac. When Valens talks about lot places from Fortune, he says that ‘some have mystically laid down the universal Hourmarker and its squares as the cosmic centrepins (*kentra*), but the Lot and its squares as the genethliological centrepins.’⁵⁸ The Lot of Fortune, representing the body and material existence, becomes a useful point from which to determine things which happen in the ‘real’ world. Also, as an astrological representative of Tyche, it can show specifically the way in which the native is affected by the ‘slings and arrows of outrageous fortune’, what happens by chance.

The Lot of Daimon, on the other hand, though it is used as an Ascendant only in that one example in Valens, shows the particular way that the native makes use of the cards she has been dealt in the real world: the ‘things to do with the soul, actions, reputations and character’,⁵⁹ in other words, the conscious, even intentional, reactions one makes as a result of the things that happen to one. This could be a decision, perhaps, to make the best of a bad situation or, more negatively, to react in a way that will bring something more unpleasant down the road. More of this will be seen in predictive techniques using the Lots of Fortune and Daimon, as in the next case.

5.4 *Case Study Number Four: Aphesis from the Lots of Fortune and Daimon*

Several chapters in Book IV lay out the use of the Lots of Fortune and Daimon in prediction. (II, 30.5–6 anticipates the technique later discussed comprehensively in Book IV.) Chapters 4–10 outline an elaborate time-lord system (the assignment of a particular planet to rule a certain period in the native’s life) using the Lots of Fortune and Daimon as ‘releasers’ (*aphetēs*)⁶⁰ for assigning different zodiac signs and their rulers to different periods of life, in order to make predictions about those periods. The periods ruled by different planets can show the astrologer which times in the native’s life are going to be difficult, either in matters concerning the body (for Fortune) or those concerning the actions one takes and one’s subsequent reputation as a result (for Daimon). Each planet is assigned to a specific period of life. How do we know which planet rules the first period (and how long is that period)? We look at the zodiac sign of the Lot of Fortune (or Daimon), and the lord, or ruler, of that

58 Valens, II, 18.6 (Pingree, 76.18–20): ὑφίστανται γὰρ τινες μυστικῶς τὸν μὲν καθολικὸν ὥροσκόπον καὶ τὰ τοῦτου τετράγωνα κοσμικὰ κέντρα, τὸν δὲ κλήρον καὶ τὰ τοῦτου τετράγωνα γενεθλιαλογικὰ κέντρα.

59 Rhetorius, ‘Investigation of Chart Factors’, *CCAG* VIII/4, 122.22–23: ... τὰ ψυχικὰ καὶ τὰς πράξεις καὶ τὰς δόξας καὶ τὸν τρόπον. For the entire text, see Appendix 8.C.

60 See the definition of *aphetēs* in Appendix 1.A, 3.1.

sign. The length of the period is based on the amount of years assigned to that planet.⁶¹ Each major period is divided into sub-periods, each with a sub-ruler, who is actually in charge of the day-to-day outcomes of the period in question, while the major ruler gives the general flavour of the period.

So, for example, if the major period zodiac sign is Sagittarius, the ruler, Jupiter, would rule overall for twelve years. But those twelve years would be divided up amongst each of the other planets (beginning with the major ruler), giving each the number of its years, but in months. So Sagittarius-Jupiter would be the sub-ruler of the first twelve months, Capricorn-Saturn twenty-seven months, Aquarius-Saturn thirty months, Pisces-Jupiter twelve months, Aries-Mars fifteen months, and so on until the twelve years is filled up. Any planets falling in those signs, or aspecting them, would be considered important to the outcome. (For a table of the planetary years of the major period lords, and the months of the sub-period lords, see Appendix 9.C.)

After explaining this in more detail than I have done here, Valens gives a long example (L75 in *GH*),⁶² in which he delineates outcomes from both Fortune and Daimon. The chart is depicted in Figure 9.5.⁶³

Valens tells us that, because of the position of the Lot of Fortune, his client died of a cough at the age of sixty-nine, when Sagittarius was the major ruler of the period, but Saturn there made this a difficult time (and the ruler of the Lot was in Cancer, which he says rules the throat). Via the Lot of Daimon, he was in an Aquarius period, with Mars squaring and Mercury opposing, and the benefics were in aversion, so he lost the trusts and acquisitions he had gained in the previous period; when he died he was in a Sagittarius-Jupiter sub-period, Jupiter being retrograde and in fall in Capricorn.

Valens' long delineation shows that he is combining effects from both the Lots of Fortune and Daimon to explain all the circumstances, both physical and mental, which led to the client's death. Effectively, the linkages between the lots are difficult to separate, as both outcomes influence each other.

61 Valens uses the minor periods (least years) of each planet: 30 years for Saturn (though for Capricorn he uses 27 years), 12 years for Jupiter, 15 years for Mars, 19 years for the Sun, 8 years for Venus, 20 years for Mercury and 25 years for the Moon. Most are based on recurrence cycles with the Sun. For more on planetary years see Bouché-Leclercq, *AG*, 409–10; Holden, *History of Horoscopic Astrology*, 89, 93; J. Tester, *A History of Western Astrology* (Woodbridge, Suffolk: The Boydell Press, 1987, repr. 1996), 86–87; *GH*, 10–11. See also 'Planetary Periods' in Appendix I.A, 2.2.

62 Valens, IV, 8.1–23 (Pingree, 158.19–160.6).

63 Note: the ☾ glyph in the chart illustration stands for the previous full moon, which occurred in Capricorn.

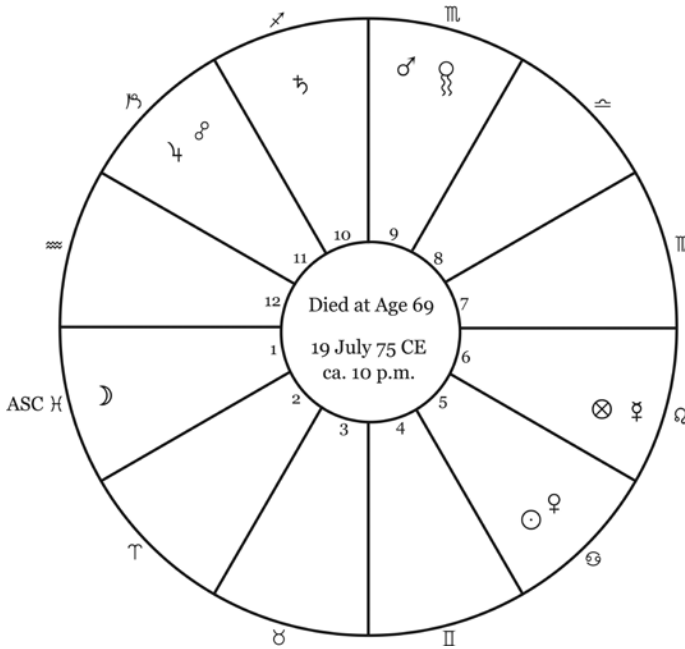

FIGURE 9.5 Chart illustrating Aphesis from *Fortune and Daimon*.

5.5 Case Study Number Five: Profections

In Book IV, Chapter 11 Valens begins a long section on ‘yearly times’ (ἐνιαυσιαῖοι χρόνοι),⁶⁴ otherwise known as profections.⁶⁵ One moves the particular point in question (e.g. the Sun or Moon) forward one sign per year, and interprets the chart according to this new position, its aspects and rulers. He devotes an entire chapter (25) to outcomes determined using four lots, Fortune, Daimon, Eros and Necessity as profected points. Here are those for the Lots of Fortune and Daimon:

64 Valens, IV, 11.6, (Pingree, 163.13).

65 This is a common predictive technique. As well as by Valens, it is given a paragraph by Ptolemy, *Tetrabiblos* IV, 10.20 (Hübner, 355.837–39): τοὺς...χρονοκράτορας ληψόμεθα... τοὺς δ’ ἐνιαυσίους ἐκβάλλοντες τὸ πλῆθος τῶν ἀπὸ τῆς γενέσεως ἐτῶν... ‘We will find... the yearly lords by casting out the multitude of years from the birth...’. The technique can also be found in Paulus, ch. 31; Olympiodorus, chs 29–33; Firmicus, II, 27–28; Hephaestio, II, 27–28; Dorotheus, IV, 1.1–64. It continues into medieval and Renaissance astrology (for example, it is fully described and delineated by W. Lilly, *Christian Astrology* (London: Tho. Brudenell, 1647, repr. Exeter: Regulus, 1985), 715–33).

The Lot of Fortune handing or taking over in operative places, with benefics in them or witnessing, indicates good fortune and promotion, both <in> actions and reputations, and setting things right, the achievement of expectations and profits from deaths. But when it is declining⁶⁶ or witnessed by malefics, it makes the actions and reputations less and temporary, or it makes whatever they may gain for themselves subject to oppositions, dangers or trials, and insults.

Daimon handing or taking over in operative places, with benefics in them, brings about the plans they have in mind, discriminating and easily effected arguments and advantageous advice from friends, and recommendations of superiors, gifts and reputation; and it brings about those who hit the mark in their enterprises, and those who are puffed up in their intellect, having a great amount of conceit. But when it has fallen astray⁶⁷ or is witnessed by malefics, it leads to mental disturbances and tortures of the soul, mental obtuseness and contrary purposes. It brings about those who consider their own faults to be right and others to be at fault, but they are the ones who miss the mark in most things, whereby such persons become faint-hearted sometimes and devise something dangerous against themselves, and they are treated as mad and come to be out of their minds.⁶⁸

For our example we return to the chart of the dancer, L123, first examined under places from the Lot of Daimon (above, 5,3, 319–21). Most of Valens' inter-

66 I.e., in a cadent place, which 'declines' or 'falls' from the angles).

67 I believe this means placed in a cadent place, or the 2nd or 8th places (these placements are considered unfortunate). Rhetorius (*CCAG VIII/4*, 124.22; 204.15, 18, 21; *CCAG VIII/1*, 240.12) is the only other astrologer to use this term in this way.

68 Valens, IV, 25.1–4 (Pingree, 191.9–26): 'Ο κλήρος τῆς τύχης παραδιδούς ἢ παραλαμβάνων ἐν χρηματιστικῶν τόποις, ἀγαθοποιῶν ἐπόντων ἢ μαρτυρούντων, εὐτυχίαν δηλοῖ καὶ προκοπήν, πράξεις τε καὶ δόξας καὶ πραγμάτων κατορθώσεις καὶ προσδοκωμένων συντέλειαν καὶ ἀπὸ νεκρικῶν ὠφελείας. ἀποκεκλικῶς δὲ ἢ ὑπὸ κακοποιῶν μαρτυρούμενος ἤττονας μὲν τὰς πράξεις ἢ τὰς δόξας παρέχει, ἀπαραμόνους δὲ ἢ ὅσα ἂν διαπράξωνται μετὰ ἐναντιωμάτων καὶ κινδύνων ἢ κρίσεων καὶ ἐπηρεῶν.

Ὁ δαίμων παραδιδούς ἢ παραλαμβάνων ἐν χρηματιστικῶν τόποις, ἀγαθοποιῶν ἐπόντων, καταθυμῶν προαιρέσεις ἀποτελεῖ, κριτικούς τε καὶ εὐκατορθώτους λογισμούς καὶ φίλων συμβουλίας ἐπωφελείς, συστάσεις τε μειζόνων, δωρεάς τε καὶ δόξας καὶ εἰς τὰς ἐπιβολὰς εὐεπιτεύκτους, παρεπρημένους τε τῇ διανοίᾳ, οἷσιν πλείστην ἔχοντας. παραπεπτωκῶς δὲ ἢ ὑπὸ κακοποιῶν μαρτυρούμενος μετεωρισμούς καὶ ψυχικὰς βασάνους ἐπάγει, ἀναισθησίας τε καὶ ἐναντιοβουλίας, τὰ ἴδια ἀμαρτήματα κατορθώσεις νομίζοντας καὶ ἄλλοις τὰς αἰτίας ἐπιφέροντας, τῶν δὲ πλείστων ἀστοχοῦντας, ὅθεν οἱ τοιοῦτοι ἐκκακοῦντες ἔσθ' ὅτε καὶ καθ' αὐτῶν κινδυνῶδες τι μηχανῶνται καὶ ὡς μανιώδεις διαλαμβάνονται καὶ ἐν ἐκστάσει φρενῶν γίνονται.

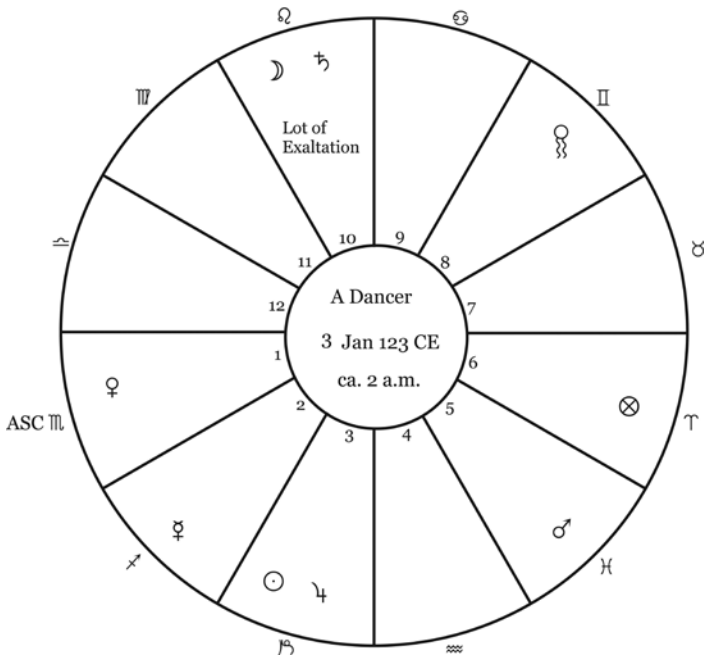

FIGURE 9.6 Chart illustrating projections from Fortune and Daimon.

pretation focuses on its profections. He first interprets the profections of the twentieth year, i.e., when the native was nineteen years old, and then the same set twelve years later.

[121] The native was a dancer. In his 20th year he came to be imprisoned because of a mob riot and, defending himself before a magistrate, was released because of the aid of his friends and the petition of the mob, after which he became more renowned. [122] For the handing over of the year was from Kronos and the Moon to Ares and the accusative place, and from Zeus and the Sun, who were in the place of authority,⁶⁹ to Kronos and the Moon, who were <in> the Midheaven and active place.⁷⁰ And especially in the division by 4,⁷¹ signs appear from Kronos and the Moon to Aphrodite and the Hour-marker, so that the riot, contentiousness and rivalry came to be through the action, and from Hermes to Ares and the accusative place. [123] And so all the stars in the 20th year were operative. The nativity incurred risk of his reputation being demolished, adverse judgement and danger of drawing his last breath. [124] But since

69 They were in the 10th place from the Lot of Fortune.

70 The tenth place is called 'praxis' (action), e.g. in Paulus, ch. 24 (Boer, 64.14).

71 Meaning the square aspects to these planets.

Aphrodite was found in the Hour-marker, <Ares> in the accusative place and Zeus with the Sun, he had an easily imaginable release and was successful concerning the action. For the Lot of Fortune was in Aries, but the lord of the exaltation for the nativity, the Sun, was found culminating with respect to the Lot [of Fortune], and Ares [culminating] with respect to the [Lot of] Daimon. [125] Later, in his 32nd year, when his honour, reputation and livelihood had been demolished, he lived without honour, because the Lot happened to be in a decline and Kronos, culminating, was out of sect and opposed to the acquisitive place, Aquarius, which was its own house—from which he himself became responsible for his downfall, having become insolent and a braggart; for the lord of the [Lot of] Daimon and the intellectual place, Hermes, was opposed to itself (that is, to Gemini).⁷²

This description seems rather impenetrable, but let us try to see what Valens is doing with the profected lots. When he was nineteen, the native managed to avoid permanent trouble because Venus in the powerful first place, and Jupiter and the Sun (ruler of the Lot of Exaltation), in the tenth place from Fortune, were able to prevail over Mars, ruler of the Lot of Fortune. In addition, Mars was in the tenth place from the Lot of Daimon. However, when this same set of profections came around again, when he was thirty-one ('in his 32nd year'), he was not so fortunate. Now, Valens emphasises that the Lot of Daimon has profected to a 'decline' (the third, Capricorn), ruled by Saturn. Saturn, though in a good position in the Midheaven, is opposed to the 'acquisitive place' (the

72 Valens v, 6.121–125 (Pingree, 219.25–220.11): <121> ὀρχηστής ὢν, διὰ στάσιν ὄχλων τῷ κ' ἔτει ἐν συνοχῇ γενόμενος καὶ ἀπολογηθεὶς ἡγεμόνι, διὰ φίλων βοήθειαν καὶ ὄχλων δέησιν ἀπολυθεὶς, ἐνδοξότερος ἐγένετο. <122> ἦν μὲν γὰρ ἡ παράδοσις τοῦ ἔτους ἀπὸ Κρόνου καὶ Σελήνης ἐπὶ Ἄρεα καὶ τὸν αἰτιατικὸν τόπον, καὶ ἀπὸ Διὸς καὶ [ἀπὸ] Ἡλίου ὄντων ἐν τῷ περὶ ἐξουσίας τόπῳ ἐπὶ Κρόνον καὶ Σελήνην ὄντας <ἐν> τῷ μεσουρανήματι καὶ πρακτικῷ τόπῳ. ἄλλως τε καὶ κατὰ τὴν [διὰ η] διὰ δ' αἴρεσιν σημαίνει ἀπὸ Κρόνου καὶ Σελήνης ἐπὶ Ἀφροδίτην καὶ ὠροσκόπον, ἵνα γένηται ἡ στάσις καὶ φιλονεικία καὶ ἀντιζήλια διὰ τὴν πράξιν, καὶ ἀπὸ Ἑρμοῦ δ' ἐπὶ Ἄρεα καὶ τὸν αἰτιατικὸν τόπον. <123> πάντες οὖν οἱ ἀστέρες τῷ κ' ἔτει ἐχρημάτισαν· εὐλαβήθη ἡ γένεσις περὶ καθαιρέσεως δόξης καὶ περὶ καταδίκης καὶ πνευματικοῦ κινδύνου. <124> Ἀφροδίτης δὲ εὐρεθείσης ἐν τῷ ὠροσκόπῳ καὶ <Ἄρεως> ἐν τῷ αἰτιατικῷ καὶ Διὸς σὺν Ἡλίῳ, εὐφαντασίωτον τὴν ἀπόλυσιν ἔσχε καὶ περὶ τὴν πράξιν εὐημέρησεν· ἦν γὰρ καὶ ὁ κληῖρος τῆς τύχης Κριῶ, τοῦ δὲ ὑψώματος κατὰ τὴν γένεσιν κύριος ὁ Ἥλιος εὐρέθη μεσουρανῶν κατὰ τὸν κληῖρον καὶ Ἄρης κατὰ τὸν δαίμονα. <125> ἐξ ὑστέρου τῷ λβ' ἔτει τιμῆς καὶ δόξης καὶ βίου καθαιρεθείς ἀτίμως διήξε διὰ τὸ ἐν ἀποκλίσει τετευχέναι τὸν κληῖρον καὶ Κρόνον παρ' αἴρεσιν μεσουρανοῦντα ἐναντιωθῆναι τῷ περιποιητικῷ τόπῳ, Ὑδροχόφῳ, ἰδίῳ οἴκῳ, ὅθεν καὶ ἐαυτῷ παραίτιος τῆς καθαιρέσεως ἐγένετο, ὑβριστῆς καὶ ἀλαζῶν γενόμενος· καὶ γὰρ ὁ κύριος τοῦ δαίμονος καὶ τοῦ διανοητικοῦ τόπου Ἑρμῆς ἐαυτῷ ἠγναντίωθη (τουτέστι τοῖς Διδύμοις).

eleventh from the Lot of Fortune), which happens to be Aquarius, Saturn's own house. He loses his livelihood and with it his reputation. Furthermore, the mind is ruled by that same Lot of Daimon, natively in Gemini and so ruled by Mercury. But Mercury, unfortunately for our dancer, opposes the Lot of Daimon and so acts against the best interests of the Lot of Daimon, the dancer's mental actions. His overweening pride and boasting get the better of him. He managed to avoid this when he was nineteen, but by the time he is thirty-one, it catches up with him—a perfect example of pride going before a fall.

We can compare Valens' interpretation here to the general conditions he lists for the profected Lots of Fortune and Daimon.

The Lot of Fortune has profected to the Hour-marker, and Venus is there. 'The Lot of Fortune handing or taking over in operative places, with benefics in them or witnessing, indicates good fortune and promotion, both <in> actions and reputations, and setting things right, the achievement of expectations . . .' (IV, 25.1). However, the profected lot is also squared by Saturn, a malefic: 'But when it is . . . witnessed by malefics, it makes the actions and reputations less and temporary, or it makes whatever they may gain for themselves subject to oppositions, dangers or trials, and insults' (IV, 25.2).

The Lot of Daimon profects to a decline, but that decline does contain Jupiter, so he will have 'discriminating and easily effected arguments and advantageous advice from friends,' (IV, 25.3) but the 'actions and reputations' will be 'less and temporary' (IV, 25.2). Furthermore, he becomes 'puffed up in his intellect, having a great amount of conceit' (IV, 25.3). The fact that the ruler of the profected Lot of Daimon is Saturn means that he works against his interests, 'devising something dangerous against himself' (IV, 25.4). The natal ruler of his lot cannot help him, because it opposes the place of the lot.

Valens has shown in this example how he intertwines the workings of the lots, so that the actions of one feed on the other, and future circumstances can be foreseen in earlier events. When the dancer was nineteen, Fortune got him out of a jam, but he didn't learn from it, so in the next round of profections Daimon's unfortunate position and his own mental actions, a hyper-arrogance about the good things which have come to him by fortune, brought about his downfall. That Valens uses the word *paraitios*, 'responsible', here shows he considers the Lot of Daimon as 'intentional' and with some qualities of what we could call free will, at least in the mental sphere. You can lead the soul to water, but you can't make her drink.

5.6 Case Study Number Six: *The Lot of Basis*

The final case study is a chart employing the Lot of Basis (previously described in Section 3 above). This is the lot formed by the arc between the Lots of Fortune and Daimon, but, we think, projected always below the Ascendant.

From Valens' descriptions of the Lot of Basis, it seems to be connected with both fortune and fame, particularly when in a relationship with the Lots of Fortune or Daimon or their lords, and especially if the lot or its lords are together with the Lots of Fortune or Daimon or their lords. Of course, the Lots of Fortune and Daimon, and therefore Basis, will only be in the same sign when the birth is at a new or full moon.

Valens gives two examples of this in practice. In both, the Sun and Moon are conjunct, making the Lots of Basis, Fortune and Daimon also conjunct in the Ascendant/first place. This is probably because Valens was showcasing notable nativities. But since these charts do not list degrees, we cannot be sure where the Lot of Basis is going to fall, above or below the horizon, and therefore we cannot be entirely sure that our interpretation of how to calculate the lot is correct. In this same section of examples, there are two charts which do not have the Sun and Moon conjunct (L86 and L101, 111 in *GH*); but these do not mention the Lot of Basis in the interpretation. We cannot be sure whether Valens intended for it to be considered, or not. However, here is an example where he does mention the lot.

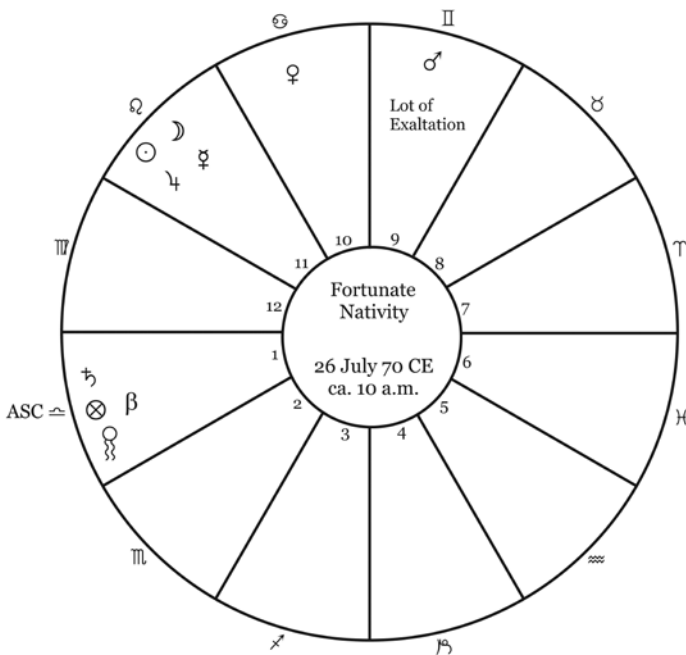

FIGURE 9.7 Chart illustrating the Lot of Basis.⁷³

73 This is No. L188 in *GH*; the chart was wrongly dated. Pingree corrected the date in his critical edition, 89, *app. crit.*: '§§1–2: thema 14 (26 Iul. 70)'. Note: the glyph β in the chart represents the Lot of Basis.

For an illustration, let the Sun, Moon, Zeus, Hermes be in Leo; Kronos, the Hour-marker in Libra; Ares in Gemini, Aphrodite in Cancer. Such a person will be fortunate, capable of leading, kingly, possessing a royal destiny and established in great abundance. For the Lots of Fortune, Daimon and Basis all fell out in the same [zodiac sign], and the lady of these was Aphrodite on the Midheaven in Cancer, and the triplicity lord and that of the Exaltation were found in the Good Daimon in the place of acquisition.⁷⁴

Since the nativity occurred at a new moon, all the lots fall in the Ascendant, Libra, whose ruler is Venus. Since she is in the tenth, always a place of authority, and the triplicity lord of fire (in this case, the Sun), as well as the lord of the Lot of Exaltation, are in the eleventh, the Good Daimon, the nativity can only be superlative!

6 Lot Calculation and the Doctrine of Sect⁷⁵

We have now seen how a Hellenistic astrologer used the Lots of Fortune, Daimon and Basis in interpretation. These interpretations show how Valens weaves the symbolism of the lots together to form a tapestry of the native's life. In particular, Valens takes care to show the way that the Lots of Fortune and Daimon, and their rulers, work together both in a physical and mental sense. The two seem to be dependent on each other, and the outcomes for the natives reflect this.

An important criterion for proper interpretation of lots is making sure the correct formula is used, based on the sect of the chart. Ptolemy alone uses only the diurnal formula for the Lot of Fortune. In general, he has no use for 'lots and numbers for which no cause can be reckoned'.⁷⁶ Since his goal was to find physical causation behind astrology, this is not surprising. Yet even Ptolemy could not ignore the Lot of Fortune; he just needed to find some kind of physical

74 Valens, II, 27.1–2 (Pingree, 89.8–14): "Ἐστω δὲ ἐπὶ ὑποδείγματος Ἥλιος, Σελήνη, Ζεὺς, Ἑρμῆς Λέοντι, Κρόνος, ὠροσκόπος Ζυγῷ, Ἄρης Διδύμοις, Ἀφροδίτη Καρκίνῳ. ὁ τοιοῦτος εὐτυχῆς, ἡγεμονικός, τυραννικός, βασιλικὴν τύχην κεκτημένος καὶ ἐν περιουσίᾳ μεγάλη κατασταθείς· ἐν τῷ αὐτῷ γὰρ ἐξέπεσεν ὁ τε κλήρος τῆς τύχης καὶ ὁ δαίμων καὶ ἡ βᾶσις, ἡ δὲ τούτων κυρία Ἀφροδίτη μεσουρανοῦσα Καρκίνῳ, ὁ δὲ τοῦ τριγώνου κύριος καὶ <ὁ> τοῦ ὕψματος εὐρέθησαν ἀγαθοδαίμονοι ἐν τῇ περιποιήσει.

75 For more on the importance of sect in calculating the Lots of Fortune and Daimon, see Greenbaum, 'Calculating the Lots'.

76 *Tetr.* III, 4.4 (Hübner, 177.197): ... διὰ κλήρων καὶ ἀριθμῶν ἀναιτιολογήτων. ...

justification for using it. He realised that if one employed only the daytime formula to construct the lot, it became a ‘lunar horoscope’—i.e., there was the same proportion between the Sun and the Ascendant as there was between the Moon and the Lot of Fortune.⁷⁷ Furthermore, if one uses only the diurnal formula, taking the arc from the Sun to the Moon, one also brings in the solilunar phase, a physical phenomenon.⁷⁸ For this reason, he could then use it as one of his aphetic points in determining length of life—the earliest material on the Lot of Fortune (in Nechepso-Petosiris as quoted by Valens) gives it this capacity of determining lifespan.

Even in antiquity, astrologers were aware that Ptolemy was iconoclastic in using only one formula: in his ‘Investigation of Chart Factors’ (see Appendix 8.C) Rhetorius remarks that

... if the Lot of Fortune and its lord happen to be well [placed], but the Lot of Daimon and its lord happen to be badly [placed] and beheld by malefics, they result in banishment for the nativity, especially for a nocturnal nativity, *on account of the Ptolemaic Lot of Fortune actually being the Lot of Daimon* (my italics).⁷⁹

What are the larger implications of this zeal to use the ‘correct’ formula? We may find some answers by returning to the prediction of length of life in ancient astrology (first discussed in Chapter Two, 2.4 and Chapter Three, 2.5).

7 The Lots and Length of Life

The luminaries and the Lots of Fortune and Daimon appear in astrological techniques on finding the length of life from the chart. It is possible that the rationale behind the use of the luminaries and Ascendant in the formulae for the Lots of Fortune and Daimon, especially in their use in calculating lifespan,

77 Ptolemy, *ibid.*, III, 11.5 (Hübner, 206.591–93):...ἵνα ὃν ἔχει λόγον καὶ σχηματισμὸν ὁ ἥλιος πρὸς τὸν ὥροσκόπον, τοῦτον ἔχη καὶ ἡ σελήνη πρὸς τὸν κλήρον τῆς τύχης, καὶ ἡ ὡσπερ σεληνιακὸς ὥροσκόπος. ‘...so that the ratio and configuration which the Sun has in relation to the Hour-marker, the Moon may also have in relation to the Lot of Fortune, and be like a lunar Hour-marker.’

78 Thanks to Joseph Crane for pointing this out.

79 *CCAG*, VIII/4, 121.7–11: εἰ δὲ ὁ κλήρος τῆς τύχης καὶ ὁ κύριος αὐτοῦ καλῶς τύχωσιν, ὁ δὲ κλήρος τοῦ δαίμονος καὶ ὁ κύριος αὐτοῦ κακῶς τύχωσιν καὶ ὑπὸ κακοποιῶν θεωρηθῶσι, ἔκπτωσιν τελοῦσι τῇ γενέσει μάλιστα ἐπὶ νυκτερινῆς γενέσεως διὰ τὸ κατὰ Πτολεμαίων κλήρον τύχης ὑπάρχειν τὸν κλήρον τοῦ δαίμονος.

is because the Sun, Moon and Ascendant are indicators of time: the Sun the month, the Moon the day, and the Ascendant ('Hour-marker') the hour.⁸⁰ This literal association with time makes them perfect representatives for discovering how long someone will live; and, in the positions of the Sun, Moon and Ascendant at birth, the ability of the beginning of life to predict the end of it.

Both Ptolemy and Valens employ the luminaries and Lot of Fortune in their (different) techniques for finding length of life. Both consider the Lot of Fortune as a possible aphetic point, from which length of life can be determined (Valens also uses the Lot of Daimon). Valens uses both diurnal and nocturnal formulae for Fortune, but we have seen that Ptolemy used only the diurnal formula for the Lot.

Hephaestio also takes up this question in his section on length of life (*Apotelesmatika*, II, 11). He follows Ptolemy and even mentions his rationale behind using only the diurnal formula, but also refers to Nechepso and Petosiris in a difficult passage, which has had to be extensively restored, on which formula to use at night.⁸¹

Though Manetho the astrologer, in his poem *Apotelesmatika*, does not mention the Lot of Fortune in his considerations on length of life, he does take the strength of the Sun and Moon into account. His general rule is to use the Sun by day and the Moon by night as the *aphetēs* (releaser), but makes an exception if the luminaries are cadent or below the horizon.⁸² This is a circumstance also addressed by Valens and by Serapion.⁸³

In fact, Valens is very concerned with using the proper formula, especially for length of life issues. In III, 11.5, the ruler of the Lot of Fortune allots a certain

80 Thanks to Micah Ross for suggesting the Sun, Moon and Ascendant as time indicators.

81 Hephaestio, II, 11.23–25. For more discussion of this passage, see Greenbaum, 'Calculating the Lots', 184–85. This passage also discussed in S. Heilen, *Hadriani genitura*, comm. on Antig. Nic., F3 §63, ὁ κλήρος τῆς Τύχης εἰς Ταύρον πίπτει.

82 Manetho, *Apotelesmatica*, III.399–415, and esp. 406–13 (Lopilato, 74): "Ὅσσοις μὲν Τιτὰν ἡοὶ ἔνι γεινομένοισιν / κέντρῳ ἔπεμβεβαῶς ἰνδάλλεται. ἐξ ἄρα κείνου / μοίρης ἀρχεσθαι βίτου χρόνου ἐξαρτιμοῦντας / νυκτερινῇ γενέθλι δὲ, Σελιηναίης ἀπὸ μοίρης. / ὅπποτε δ' ἂν κέντρων ἐκτὸς φαέθοντ' ἀποκλιθῆ, / ἥτ' ἂν ἐνὶ μοίραισι κατωφερέεσσι πόλοιο / | νίσηται προθέοντα. τὸτ' ἀστέρος ἀρχεο κείνου, / ὅς ῥά τε δεσπόζει γενέθλης. μέγα τε κράτος ἴσχει. 'For whomever being born in the daytime Titan [the Sun] is seen / standing on a centrepin, from that / degree begin to count out the time of life; / and in a nocturnal nativity from the degree of the Moon. / When the shining ones have declined outside the centrepins / or proceed in their headlong course / in the degrees of the lower hemisphere, then begin with that star /which rules the geniture, since it has great power.' (My translation following Lopilato, 237.)

83 CCAG VIII/4, 228.1–16. See Greenbaum, 'Calculating the Lots', 180–83.

amount of years to the native depending on its position. Valens also says, quoting and then interpreting Nechepso (III, 11.3–5), that the diurnal formula is used at night when the Moon is below the horizon; but he also tells us that if the Lot or its lord ‘falls astray’, then ‘Daimon and the horoscopic place’ can be used (III, 11.12).⁸⁴ He makes a similar statement in Book IV, 4.5–6.⁸⁵ This chapter, as we saw in 5.4 above, also details Valens’ use of both the Lots of Fortune and Daimon as aphetic points, determining events of the native’s life and circumstances of his death.

In Book IX, Chapter 2, Valens devotes an entire chapter to the Lots of Fortune and Daimon and their use in both quality and length of life. He tells us that the two lots are combined to give information about lifespan:

Regarding lengths of life the two lots are combined; both in relation to the Sun and the Moon and the degree-separation between them, and in relation to the Hour-marker, the planetary-marker⁸⁶ and its degree, they show plainly the years likely to be lived from the distance between them. They measure the half [of the entire distance] in one direction and then the other, either adding to the longitude of the hour-marker [*i.e. in zodiacal order*], or falling short of [*i.e. subtracting from*] this [longitude] [*i.e. in diurnal order*], so two degrees of the zodiac are necessarily operative, and the nativity, though subject to death, takes up the life-giving breath in relation to the sympathy of the cosmos.⁸⁷

84 Pingree, 147.30–32: Τὸ δ’ αὐτὸ καὶ ὁ δαίμων καὶ ὁ ὠροσκοπικὸς τόπος ἐφρέξει τῷ κλήρῳ κατὰ τὸν μερισμὸν ὁπόταν οἱ κληρικοὶ τόποι ἢ οἱ κύριοι παραπέσωσιν, μάλιστα ὁπόταν ὁ κλήρος τῷ δαίμονι τὸν μερισμὸν ἐκχωρήσῃ. ‘[The Lot of] Daimon and the Hour-marking place will have the same function as the Lot [of Fortune] in the apportionment whenever the lot places or their lords should fall astray, especially when the Lot cedes the apportionment to the Daimon.’

85 Valens’ positions are explored in detail in Greenbaum, ‘Calculating the Lots’, 181–82.

86 This must mean the position of each luminary involved.

87 IX, 2.5 (Pingree, 319.7–14): πρὸς δὲ τοὺς τῆς ζωῆς χρόνους συγκρινόμενοι οἱ δύο κλήροι, πρὸς τε τὸν Ἥλιον καὶ τὴν Σελήνην καὶ τὴν μοιρικὴν αὐτῶν ἀπόρροιαν, πρὸς τε τὸν ὠροσκόπον καὶ τὸν πλανητικὸν σκοπὸν καὶ τὴν μοίραν προδηλώσουσι καὶ τοὺς βιωσίμους χρόνους ἐκ τοῦ διαστήματος, τὴν ἡμίσειαν ἔμπαλιν καὶ ἀνάπαλιν ἐκμετρηθέντες, ἢ προλαβόμενοι τοῦ μεγέθους τῆς ὥρας ἢ ἀπολειφθέντες τούτου, ὡς δύο μοίρας χρηματίζειν τοῦ ζωδι<ακ>οῦ ἐξ ἀνάγκης, τὴν δὲ γένεσιν καίπερ ἐπίκηρον οὖσαν πρὸς τὴν τοῦ κόσμου συμπάθειαν τὸ ζωτικὸν ἀναλαβεῖν πνεῦμα. (I emend ζωδίου το ζωδι<ακ>οῦ.) For rich commentary on this passage (and an interpretation different from mine), see Heilen, *Hadriani genitura*, comm. on Antig. Nic. F3 § 63, ὁ κλήρος τῆς Τύχης εἰς Ταῦρον πίπτει. I thank him for much useful information and fruitful discussions on this topic, and especially for drawing my attention to the importance of this chapter for the two lots.

This passage is part of a larger section containing circumstantial evidence to show that Nechepso and Petosiris used the Lot of Daimon in length and quality of life issues. Stephan Heilen, in a persuasive proposal, has argued⁸⁸ that the Lot of Daimon as well as the Lot of Fortune was treated by them. We have already seen supporting testimony that this was the case, especially in Valens III, 11, where a main point of the chapter is that the Lot of Daimon can also be used in determining length of life, where the King and also ‘the ancient one’⁸⁹ (Petosiris?) are quoted extensively in techniques for calculations of the Lot of Fortune; and where a technique endorsed by Nechepso results in the use of the *de facto* Lot of Daimon (III, 11.3–5).

Heilen’s proposal focuses on the context around IX, 2.7 (attributed to Petosiris), namely IX, 2.1–8, where uses of the two lots concern length and quality of life.⁹⁰ He has made a compelling case, based on context, precedents and supporting texts, for interpreting IX, 2.7 as referring, not solely to the Lot of Fortune, but also to the Lot of Daimon: Petosiris actually refers to *both* lots by their respective daytime formulae.⁹¹ The pertinent part of the passage reads:

Petosiris does not speak aimlessly [*i.e.*, *without a goal in mind*] in the *Definitions* about the sympathy of the Sun and Moon: whether the [separation] from the Sun to the Moon and the equal amount from the Hour-marker, or from the Moon to the Sun and the equal amount from the Hour-marker, you will find [that amount] falling by the same [interval] into [the respective zodiac sign/place]. . . .⁹²

88 See Heilen, *Hadriani genitura*, comm. on Antig. Nic. F3 § 63, ὁ κλήρος τῆς Τύχης εἰς Ταῦρον πίπτει. I thank him for letting me see this important analysis prior to publication.

89 III, 11.7 (Pingree, 147.17): ὁ παλαιός.

90 The title of the chapter is ‘On the Lots of Fortune and Daimon in the topic concerning Effective and Ineffective Times and Length of Life’, IX, 2.t (Pingree, 318.13–14): Περὶ κλήρου τύχης καὶ Ὡ εἰς τὸν περὶ ἐμπράκτων καὶ ἀπράκτων χρόνων καὶ ζωῆς τόπον (my redrawing of the glyph for Daimon, in cod. Oxon. Selden 22, 153r; redrawn in CorelDraw). This section is full of citations and possible allusions to Nechepso and Petosiris (see, e.g., Heilen, ‘Metrical Fragments’, 58–61; idem, *Hadriani genitura*, F3 § 63, ὁ κλήρος τῆς Τύχης εἰς Ταῦρον πίπτει).

91 I shall not go into the ramifications of his argument here, but refer the reader to his book: *Hadriani genitura*, comm. on Antig. Nic. F3 § 63, ὁ κλήρος τῆς Τύχης εἰς Ταῦρον πίπτει.

92 (Pingree 319.17–21): οὐκ ἀσκόπως δὲ ὁ Πετόσιρις περὶ συμπαθείας Ἥλιου καὶ Σελήνης λέγει ἐν τοῖς Ὀροις· εἶτε τὴν [sc. ἀπόρροϊαν] ἀπὸ Ἥλιου ἐπὶ Σελήνην καὶ τὰ ἴσα ἀπὸ ὠροσκόπου εἶτε ἀπὸ Σελήνης ἐπὶ τὸν Ἥλιον καὶ τὰ ἴσα ἀπὸ ὠροσκόπου, κατὰ τὸ αὐτὸ ἐμπεπτωκότα εὐρήσεις, ὁράται τε ἔνθεν ὁ διακρατῶν τοῦ ζητουμένου, πρὸς δὲ τὰ ὅλα τετύχηκε καὶ συμβήσεται! (‘ἀπόρροϊαν’ to accord with its use in IX, 2.5: see, in this context, Heilen’s rich word analysis, in *Hadriani*

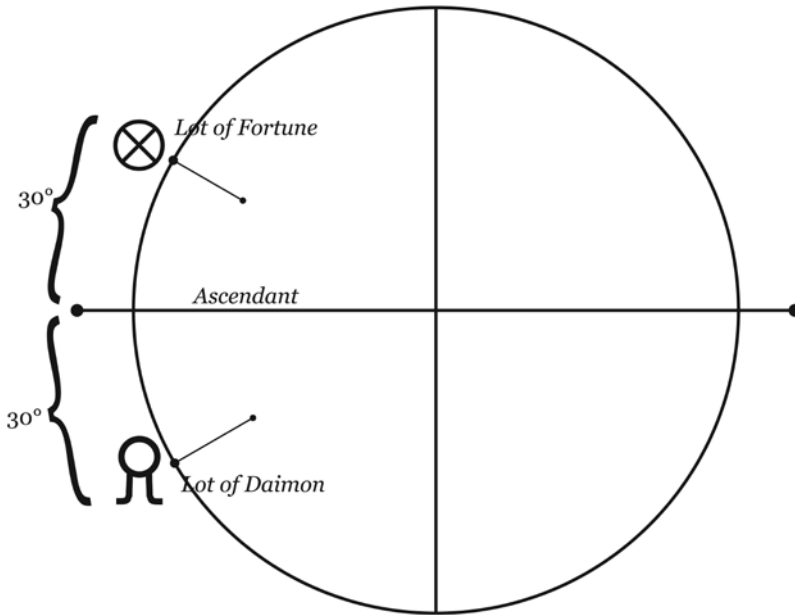

FIGURE 9.8 *Equal distance of the lots from the Ascendant.*

Thus, what the passage really means is that the *distance of the two lots from the Ascendant* is the same, whether in one direction or the other (one direction producing the Lot of Fortune, and the other producing the Lot of Daimon).

If Heilen's proposal is correct, it adds to the circumstantial evidence that the earliest writers on Hellenistic astrology used both the Lot of Fortune and the Lot of Daimon in their techniques, especially regarding the length of life and also, as the title of IX, 2 indicates, the 'effectiveness and ineffectiveness' of certain times of life.

IX, 2 thus enhances the power of the two lots and the importance of the day and night formulae for Hellenistic astrology. Two comments may be made in this regard. First, the issue of which formula—day or night—to use seems to

genitura, comm. on Antig. Nic. F3 § 63, ὁ κληῖρος τῆς Τύχης εἰς Ταῦρον πίπτει.) My translation follows Heilen's interpretation, *ibid.*; I follow his proposed reconstruction of this passage ('Metrical Fragments', 57), based on Kroll's insertion of the comma after the second ὠροσκόπου. My translation in Greenbaum, 'Calculating the Lots', 177, should now be superseded. For my translation of II, 3.1 (176) and IX, 2.8 (177), I now agree with Heilen that ἔμπαλιν is iterative ('again') not spatial. My conclusion (177–78, Fig. 3b, Interpretation no. 2), that the lots effectively are found by projecting the Sun-Moon arc in opposite directions from the Ascendant, remains correct.

arise mainly in questions of life expectancy (both for Valens and for Ptolemy, who are the main delineators of the technique). For Ptolemy, any nocturnal chart would show what other astrologers called the Lot of Daimon, not the Lot of Fortune (Rhetorius even points this out). The Lot of Daimon, therefore, whether *de facto* or *de jure*, is fully involved in this determination. Life expectancy requires finding the most powerful place in the chart, and the first things the astrologer looks at are the Sun and the Moon. The power of the luminary is dependent on its sect, dignity and placement in the chart. Each luminary is stronger when in its own sect: the Sun in the day, the Moon at night. The formulae for the Lot of Fortune clearly try to take this into account, in that the planet from which the arc is calculated is the planet in sect. When there are variations in this method, they are because the sect luminary is weakened (and, of course, only the nocturnal formula is affected).

Secondly, practice as well as theory may have dictated that two lots, in their day/night formulae, were better than one: astrologers may have found it difficult to get consistent results on life expectancy only from one lot formula, and so used both as needed. This could be the reason why Valens makes so much of which formula to use, and perhaps even why he places so much emphasis on the Lot of Daimon in other contexts.

8 Conclusions

While the overt use of the Lot of Daimon is limited (but not absent) in discussions of life expectancy, it is often used in natal interpretation, time-lord systems (*Aphesis* from Daimon) and in profections, to show the mental state of the native and to show how this mental state interacts with the events seen to be brought about by the Lot of Fortune. In addition, it is considered a factor in physical and mental illness. It is sometimes difficult to disentangle the effects of both of the lots, since at times they are seen as responsible for the same outcome. Remember that in the chart of attributions of the Lots (Table 9.1), both Fortune and Daimon were assigned reputation and actions. The two lots, separated in the chart, nevertheless remain joined by the bond of the Ascendant, from which they equally project.

Chance and Endowment, Fortune and Daimon, as Freud says, are *both* responsible for a man's life; neither is alone responsible. We take what we have been endowed with—let's call it talent—and apply it to what life brings us. Our circumstances—our luck, if you will—are informed by this gift and how we choose to use it. The chance events that befall us are what test us in physical, mental and spiritual ways. Here happenstance meets intentionality. The

influence is mutual, not sequential. Circumstances evoke action and reaction, based not only on physical impulses but also on mental ones. We choose how to react; the reaction may be based on past habit, or it may be more liberated from it, but there is always the possibility of conscious intention.

Underlying all the interpretive moves Valens makes is a foundation based on the interaction between chance and intention. The Lots of Fortune and Daimon and their midpoint, the Ascendant, demonstrate this foundation. (The Lot of Basis is both a literal and a metaphorical symbol of this combination.) In his work, as in the work of Paulus, Olympiodorus, Firmicus and Rhetorius, Valens seems to acknowledge, in the dependency of Fortune and Daimon on each other, this relationship between chance and intention, the body's desires and the soul's decisions.

It is strange that, throughout all his delineations, Valens keeps allowing for 'escape clauses' from an afflicted lot or planet ruling the lot. Fortune can substitute for Daimon, or the other way around. The Moon can take over from the Sun and vice versa. Why might this be? It is perhaps because Valens cannot let go of the idea that we are in some ways responsible for our lives, and the astrological scheme can show this: there are escape clauses both in astrology and in life (we *can* learn from our mistakes). Valens may be deterministic in his outlook (as may most astrologers), but he is not a fatalist. Peter Struck, talking about the Stoic position on fate, has articulated the difference between determinism and fatalism:

Determinism tells us that, given the totality of causal conditions at one time, what happens next is entirely determined. However, fatalism, in the sense in which the term is commonly used, claims something slightly different. It states that everything is determined to happen, *independent of* human choices, efforts or deliberations. But Chrysippus never claimed that. Our choices, effort, and deliberations do matter in his picture.⁹³

We could ask 'How much does happenstance influence intentionality?'⁹⁴ Or perhaps it would be better to say, 'What is the relationship between happen-

93 P. Struck, 'A World full of Signs: Understanding Divination in Ancient Stoicism', in *Seeing with Different Eyes: Essays in Astrology and Divination*, ed. Patrick Curry and Angela Voss (Newcastle: Cambridge Scholars Publishing, 2007), 11 (*italics* Struck's). This essay, I think, has implications for astrology, so I will explore it in some detail. For more on fatalism versus determinism, see R. Sharples' introduction in Alexander of Aphrodisias, *On Fate*, ed. and trans. Robert W. Sharples (London: Duckworth, 1983), 9–10.

94 My thanks to Marcia Butchart for discussing this section with me.

stance and intentionality?' What we see in astrological interpretations, like Valens' of the dancer, is the reciprocal nature of happenstance and intentionality.⁹⁵ The causes of the dancer's elevation and fall—events and his decision, i.e. his intention, on how to behave—are mutually dependent and reciprocal. And the representatives of this reciprocation are the Lots of Fortune and Daimon (we see reciprocation and mutuality even in the very formulae for the lots).

There is another intentionality to be considered here, and that is divine intentionality.⁹⁶ If we think that events in the world are determined, but that we can discover things in advance by the grace of the gods and our own wisdom, does this say anything about the intentionality of the gods/ensouled cosmos to provide such guidance through divination in general and astrology in particular? Who makes the patterns—we or the gods?⁹⁷ Or are we imprinted or endowed with the ability to see the patterns, to receive the signs and put together the symbols?⁹⁸ For the ancients, is this the endowment that the daimon provides? Is it, then, the daimon who is the bearer of intention from god to human?

Both we and the gods have an interest in communication. As Struck points out, 'the divine sign' is 'an act of communication.'⁹⁹ If this is the case, then again the daimon works as the mediator, communicator and administrator between the divine and human. In astrology the Lot of Daimon, the lot of *nous* and *phronēsis*, is a symbol of this mediation. As an analogue to the Lot of Fortune, it is the third point of the triangle created by Fortune, Daimon and the Ascendant.¹⁰⁰ This, then, points to an intentionality on both sides, both human and divine—for the gods who intend us to read the patterns, and for ourselves who, with our own ability for intention, can make up our own minds.

95 Struck, 'World full of Signs', 12–13, also takes up this issue. His thoughts have helped prompt my own.

96 A 'purposive cosmos', as Struck, *ibid.*, 16, points out, was accepted by most ancient philosophers.

97 I thank Darby Costello for conversations on this subject which have helped with these questions and conjectures.

98 Struck suggests following the lead of Walter Burkert in this regard, positing an 'early [human] evolutionary state and a divinatory mentality'. See Struck, 'World full of Signs', 18 and n. 35, referring to W. Burkert, *Creation of the Sacred: Tracks of Biology in Early Religions* (Cambridge, MA: Harvard University Press, 1996). See esp. 156–63. Burkert tells us (163) that 'humans construe their *kosmos* of sense. It hints at the divine.'

99 Struck, 'World full of Signs', 17.

100 Strangely, the form they make is an isosceles triangle, that called daimonic by Xenocrates (cited in Plutarch, *De defectu oraculorum*, 416d).

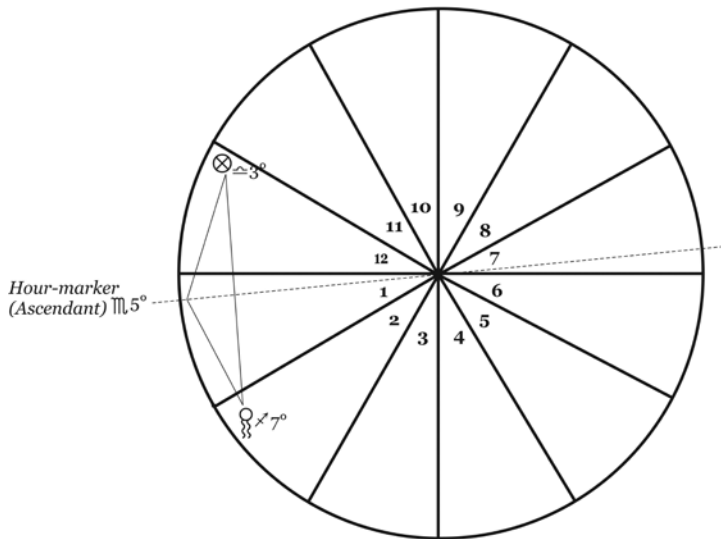

FIGURE 9.9 *An isosceles triangle with lots and Ascendant*

Throughout the history of Greek astrology, from Dorotheus through Valens to Rhetorius,¹⁰¹ both the Fortune and Daimon lots were closely linked, and could even substitute for each other in chart interpretation. In description and interpretation, the two are spoken of as if they were variations on a theme, or as the mirror images which they actually are in the chart. Theirs is a ‘secret mutual connivance’ hiding in plain sight, and it is the astrologer who must take note of it.¹⁰² Just as in the culture of the Greco-Roman world Tyche and Daimon form a pair linked to divination, lots, and even toasts to health, the Lots of Fortune and Daimon cannot be astrologically interpreted in isolation from each other. The Sun and Moon that form them, the happenstance of the time and space tie (the Ascendant) that binds them—these create links that forge in astrological language the reflection of reality shown in the chart. The Hellenistic astrologers, literally, cannot separate body from mind, soul from spirit.

101 I.e., the ‘5th consideration’ on Fortune and Daimon: see Appendix 8.C.

102 The phrase ‘secret mutual connivance’ comes from C. G. Jung, *Synchronicity—An Acausal Connecting Principle*, trans. R. F. C. Hull (London: Routledge & Kegan Paul, 1972), 85. (Also in C. G. Jung, *The Collected Works of C. G. Jung*, vol. 8, trans. R. F. C. Hull (London: Routledge & Kegan Paul, 1960), 478.) Jung speaks of this in terms of the correspondence between the astrologer’s psychic state and the astrological material.

'Parents of Human Civilisation': The Lots of Love and Necessity

Eros und Ananke sind auch die Eltern der menschlichen Kultur geworden.

SIGMUND FREUD¹

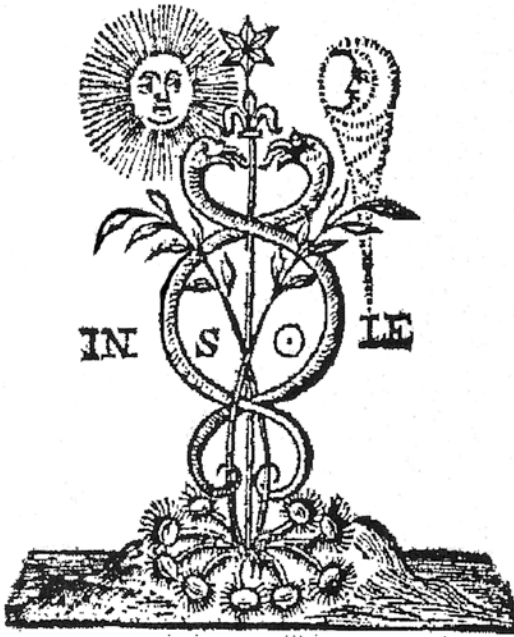

FIGURE 10.1 A Caduceus.²

- 1 S. Freud, *Das Unbehagen in der Kultur* (Vienna: Internationaler Psychoanalytischer Verlag, 1930), 64; also S. Freud, *Civilization and its Discontents*, trans. Joan Rivière, in *Complete Psychological Works of Sigmund Freud*, ed. James Strachey (London: The Hogarth Press and the Institute of Psychoanalysis, 1961, repr. 1973), vol. 21, 101 ('Eros and Ananke [Love and Necessity] have become the parents of human civilization too!').
- 2 In *Das Geheimniss der Hermetischen Philosophie, in welchem die Verborgenheit der Natur und der Kunst, die Materie und Weise zu würken betreffende, vom Steine der Weisen, durch gewisse Regeln ordentlich geoffenbaret wird. Aus der dritten vermehrten und verbesserten Lateinischen Ausfertigung Parisischen Drucks ins Hochdeutsche übersetzt* (Frankfurt and Leipzig: In der Fleischerischen Buchhandlung, 1770), title page.

Prologue: Macrobius's Caduceus

Macrobius, who wrote in the late fourth and early fifth centuries, is known for two works, the *Commentary on the Dream of Scipio* and the *Saturnalia*. In both of these he shows his familiarity with current religious and philosophical traditions, including Pythagoreanism, Orphism, Platonism and what we now call Neo-Platonism. It is also obvious that he had at least a working knowledge of astrology and astrological principles, for both the *Commentary* and the *Saturnalia* contain discussions on the planets, the zodiac and the use of astrology.³ Several chapters of the *Saturnalia* are devoted to syncretizing other gods with the Sun,⁴ and within those chapters is the following:

[16] Another clear proof that it is the sun that we worship under the name of Mercury is the caduceus, which the Egyptians⁵ have designed as the sacred staff of Mercury. It shows a pair of serpents, male and female, intertwined; the middle parts of the serpents' coils are joined together as in a knot, called the knot of Hercules; their upper parts are bent into a circle and complete the circle as they meet in a kiss; below the knot their tails rejoin the staff at the point at which it is held, and at that point appear the wings with which they are provided. [17] The Egyptians also maintain that the attributes of the caduceus illustrate the nativity, or 'genesis' as it is called, of mankind; for they say that four deities are present to preside over a man's birth: his *Daimōn*, *Tuchē*, *Erōs* and *Anankē* [Daimon, Fortune, Love and Necessity]. By the first two they understand the sun and the moon; for the sun, as the source of the breath of life and of heat and of light, is the creator and the guardian of a man's life and is therefore believed to be the daimon, or god, of a newborn child; the moon is *Tuchē* [Fortune], since she has charge of the body, and the body is at the mercy of the fickleness of change; the kiss of the serpents is the symbol of Love; and the knot is the symbol of Necessity. [18] Why wings are added has already been explained, and of the above-mentioned attributes the coiled bodies of the serpents have been specially chosen, as

3 *Commentary*, I, 12, 19, 20.1–8, 21; II, 11; *Saturnalia*, I, 19.16–18, 21.

4 Perhaps in an effort, during a period where Christianity was becoming ever more powerful, to 'monotheize' paganism.

5 Recall Chapter 3, Figure 3.2, right (no. 3180), 82, and Figure 3.3, 86, with the caduceus pictured with the Agathos Daimon; Dunand mentions a few more such images in LIMC I/1, 281 (nos 31–35).

illustrating the serpentine course of each of the two stars [*i.e.*, *Sun and Moon*].⁶

The four birth deities Macrobius describes in this passage correspond to four astrological lots mentioned by Vettius Valens, Paulus Alexandrinus and others. We examined Fortune and Daimon in the previous chapter, but the others mentioned in this quotation, Eros (Love) and Necessity, are equally worth considering. As we shall see, in one calculation format, the lots of Eros and Necessity are formed from the lots of Fortune and Daimon, which is why this chapter is devoted to them. They are significant not only in the astrological world but in the world of Hellenistic philosophy and religion.⁷ It is scarcely an overstatement to say that the concepts of Love and Necessity are fundamental to Greek culture, mythology, religion and philosophy, and perhaps even to the study of what is called 'natural science'.

This chapter starts with the religious, philosophical and cultural understanding of Eros and Ananke. Then we revisit Macrobius's caduceus in light of these findings. Next, we explain how the lots of Eros and Necessity⁸ were used in astrological technique; and finally, we discuss the interpretations of Eros and Ananke within astrological technique in combination with their wider interpretations within the Hellenistic astrological timeframe. Our first investigation of these concepts will provide a backdrop against which to place their position in astrological technique; and then within astrological technique, to examine the

6 Macrobius, *Saturnalia*, I, 19.16–18 (Willis, I, 111.4–24): '[16] In Mercurio solem coli etiam ex caduceo claret, quod Aegyptii in specie draconum maris et feminae coniunctorum figuraverunt Mercurio consecrandum. Hi dracones parte media voluminis sui in vicem nodo quem vocant Herculis obligantur, primaeque partes, eorum reflexae in circulum pressis oculis ambitum circuli iungunt, et post nodum caudae revocantur ad capulum caducei ornanturque alis ex eadem capuli parte nascentibus. [17] Argumentum caducei ad genituram quoque hominum, quae γένεσις appellatur, Aegyptii protendant, deos praestites homini nascenti quattuor adesse memorantes, Δαίμονα Τύχην Ἐρωτα Ἀνάγκην, et duos priores solem ac lunam intellegi volunt, quod sol auctor spiritus caloris ac luminis humanae vitae genitor et custos est, et ideo nascentis Δαίμων, id est deus, creditur: luna Τύχη, quia corporum praesul est quae fortuitorum varietate iactantur: Amor osculo significatur; Necessitas nodo. [18] Cur pennae adiciantur, iam superius absolutum est. Ad huius modi argumenta draconum praecipue volumen electum est propter iter utriusque sideris flexuosum.' Trans. (slightly modified) of P. V. Davies, in Macrobius, *The Saturnalia*, trans. and annot. Percival Vaughan Davies (New York: Columbia University Press, 1969), Book I, 19.16–18, 135–36. Used with permission of the Columbia University Press.

7 Though the three fields would not have been culturally separated.

8 I shall consistently call the lots 'Eros' and 'Necessity' throughout this chapter. Otherwise, I shall mostly refer to the deities/daimons as 'Ananke' and 'Eros'.

astrological philosophy behind them. Some astrological practice associates the lots of Eros and Necessity very specifically with the Lots of Fortune and Daimon. This astrological link of Eros and Ananke to Tyche and Daimon may also provide us with insights on how they were perceived in other areas.

1 Eros and Ananke in Greek Religion and Philosophy: An Overview

1.1 *The Early Tradition*

Hesiod counts Eros among the three initiating gods in the *Theogony*, along with Chaos and Gaia (Earth). Eros is ‘most beautiful among the deathless gods’;⁹ after Aphrodite’s birth, Eros and Himeros (Longing/Desire) follow her.¹⁰ Ananke is not mentioned as a divinity in the *Theogony*, but the word is used with the sense of a force or constraint, and even at this early stage is joined with the idea of binding.¹¹ In the first Homeric Hymn to Aphrodite we find the liaison of Aphrodite and Anchises, she being ‘compelled’ by Zeus to have a relationship with a mortal man. This ‘erotic *anankē*’, as Hugh Parry describes it, is Eros not by persuasion but by compulsion, and intimates a force linked to subjugation, taming and enslavement.¹² Zeus delivers this *anankē*, though; it is not yet a divinity on its own.¹³

For both Parmenides and Empedocles, Ananke has become a goddess (actually, she is called a daimon). Parmenides’ cosmogony contains bands (*stephanai*) which ‘cross one another’ (Testimonia A37),¹⁴ described thus:

9 *Theogony*, 120 (West): ἡδ’ Ἔρος, ὃς κάλλιστος ἐν ἀθανάτοισι θεοῖσι. . .

10 *Theogony*, 201.

11 Ἀνάγκη appears twice in the *Theogony*, at 517 and 615. Context shows this connotation of force or constraint. The first reference is to Atlas holding up the sky ‘κρατερῆς ὑπ’ ἀνάγκης’, ‘under masterful constraint’. The second, associating ἀνάγκη with binding, is to Prometheus, who was bound by force, ‘. . . ὑπ’ ἀνάγκης . . . μέγας κατὰ δεσμὸς ἐρύκει.’ Note that Atlas and Prometheus, both associated with force or constraint here, are brothers, the sons of Iapetus and Clymene (*Theog.* 507–11). See Hesiod, *Theogony*, trans. Hugh G. Evelyn-White, in *Hesiod; Homeric Hymns; Epic Cycle; Homeric* (Cambridge, MA: Harvard University Press, 1914, repr. 1995); *The Homeric Hymns*, trans. and annot. Apostolos N. Athanassakis (Baltimore: Johns Hopkins University Press, 1976), 47–55, notes 92–96; Hesiod, *Theogony, with prolegomena and commentary*, ed. M. L. West, (Oxford: Clarendon Press, 1966, repr. 1997).

12 H. Parry, ‘The Homeric Hymn to Aphrodite: Erotic *Ananke*’, *Phoenix* 40 (1986): 253–64, here 255, 257. *Anankē* in the *Iliad* (6.458) is tied to the enslavement of Andromache (Parry, 258).

13 Zeus may be the provider of *anankē* in this poem, but later, when *anankē* acquires its connections with fate, ‘even Zeus cannot escape fate’.

14 D-K, I, 224.

Fragment B12: For the narrower [bands] are filled with unmixed fire... and in the middle of them a daimon which governs all; for she rules over hateful childbirth and union,¹⁵ sending female to mingle with male and the opposite again, male with female...¹⁶

Fragment B13: First of all the gods she crafted Eros...¹⁷

Testimonia A37 (Aëtius, II 7, 1):... Of the mixed [bands], the middlemost is actually the <beginning> and <cause> of motion and birth for all of them, which he [Parmenides] names both a governor and an allotter daimon, namely Justice (*Dikē*) and Necessity.¹⁸

-
- 15 μίξις, lit. 'mixing', 'mingling' (LSJ, s.v.) but also the usual word for sexual intercourse.
- 16 D-K, I, 242.12, 243.2–5: αἱ γὰρ στενιότεραι πλήντο πυρὸς ἀκρήσιοι, /... / ἐν δὲ μέσῳ τούτων δαίμων ἢ πάντα κυβερνᾷ. / πάντα γὰρ <ἢ> στυγεροῖο τόκου καὶ μίξις ἀρχεῖ / πέμπουσ' ἄρσενι θῆλυ μιγῆν τό τ' ἐναντίον αὐτίς / ἄρσεν θηλυτέρῳ. (Diels reads πλήντο for πλήνται of Tarán in Parmenides, *Parmenides: A Text with Translation, Commentary and Critical Essays*, trans. and comm. Leonardo Tarán (Princeton: Princeton University Press, 1965), 166–67 and Gallop in Parmenides, *Parmenides of Elea: Fragments. A text and translation with an introduction*, trans. David Gallop (Toronto: University of Toronto Press, 1984), 82). My translation following Gallop.
- 17 D-K, I, 243.16: πρῶτιστον μὲν Ἔρωτα θεῶν μητίσατο πάντων...
- 18 D-K, I, 224.7–9: τῶν δὲ συμμιγῶν τὴν μεσαιτάτην ἀπάσαις <ἀρχήν> τε καὶ <αἰτίαν> κινήσεως καὶ γενέσεως ὑπάρχειν, ἣντινα καὶ δαίμονα κυβερνήτην [vgl. B 12, 3] καὶ κληροῦχον [B 1, 14] [I am reading κληροῦχον] ἐπονομάζει Δίκην τε καὶ Ἀνάγκην [B 8, 30; 10, 6]. At 224, in the *app. crit.* to line 9, Diels says 'κληροῦχον Fülleborn: κληροῦχον Aët.' Quotation in Stobaeus, *Anthologium*, I, 195.9–12 (1a); Fülleborn has emended κληροῦχον in Mss F and P to κληδοῦχον. I translate κληροῦχον, 'allotter', rather than κληροῦχον, 'key-holding'. Most translations prefer 'key-holding' and/or treat the four descriptives for δαίμονα as an unseparated series (e.g. Gallop, *Parmenides Fragments*, 116; Barnes, *Early Greek Philosophy*, 138; Guthrie, *HGP*, II, 61–62; Burnet, *Early Greek Philosophy*, 187, 190 and n. 3). In contrast with these translations, I think the first two descriptions of δαίμονα, 'governor' and 'allotter' are linked by their proximity and by their status as nouns, and the second two form another set, separated by the verb; in the first set the noun 'governor' connects to Dike in the second set, while 'allotter' in the first set connects to Ananke in the second. This interpretation gives more grammatical weight to κληροῦχος as correct (LSJ, s.v., has it only as a noun), since κυβερνήτης is also a noun. If this is the case, then Justice governs or steers and Necessity allots. Re 'keyholder' versus 'allotter', Burnet (190, n. 3) also favours the 'lots' version, as does Tarán, *Parmenides*, 248. Guthrie, *HGP*, II, 62, n. 2 says 'this may be right' (though finally he rejects it for 'keyholder'). Most prefer 'keyholder' because Justice holds the keys in Fragment 1 (D-K, I, 229.9, Parmenides B1: ... Δίκη πολύποινος ἔχει κληίδας ἀμοιβούς.) However, I am persuaded (as is Burnet) that κληροῦχον fits better with Necessity because of Necessity's association with allotment. For other examinations of this Aëtius quotation, see J. S. Morrison, 'Parmenides and Er', *JHS* 75 (1955): 59–68, esp. 60–65; and A. Finkelberg, 'The Cosmology of Parmenides', *AJPh* 107, no. 3 (1986): 303–17

Who is this daimon? Plutarch names her as Aphrodite,¹⁹ which makes sense because of the association with Eros and (sexual) union. Guthrie agrees with this position.²⁰ Here, the mingling that Aphrodite (the principle of Love) does is with Justice and Necessity. Two (Platonic) thoughts come immediately to mind: Diotima's characterisation of Eros as a great daimon (see below); and, unmistakably, the Myth of Er, where Necessity is the central spindle about which the planets revolve, and Lachesis, the daughter of Necessity, allots each soul the daimon that they choose.²¹ Parmenides' fragments thus align with Plato's characterisation of Ananke in the Myth of Er.²² They also evoke the Orphic deities Eros and Ananke (Adrasteia), as we shall see.

Other fragments mention the goddess/daimon Necessity: '... you will know too the sky which encloses it [the Moon]—whence it grew, and how Necessity led and fettered it to hold the limits of the stars';²³ and '... strong Necessity holds [it] fast in the chains of a limit, which fences it about.'²⁴ Again Necessity is associated with binding and, significantly, with the stars.

1.2 *Empedocles*

Love (*philotēs* = *philia*) and Strife (*neikos*) figure prominently in Empedocles' cosmology as the joining and separating forces of the four 'roots' (*rhizomata*), corresponding to the four elements. Empedocles' usual word for 'Love' is *philia*, also associated with Aphrodite (but Empedocles does not use the word Eros).²⁵

(both Morrison and Finkelberg are primarily interested in the components of the bands, not in the goddess/daimon).

- 19 *Amatorius* 756e–f: Plutarch, *Amatorius*, trans. W. C. Helmbold, in *Moralia*, ix (Cambridge: Harvard University Press, 1961, repr. 1999). For the argument that here Parmenides refers to the planet Aphrodite, see G. Cerri, 'The Astronomical Section in Parmenides' Poem', in *Parmenides, Venerable and Awesome (Plato, Theaetetus 183e). Proceedings of the International Symposium (Buenos Aires, October 29–November 2, 2007)*, ed. Néstor-Luis Cordero (Las Vegas/Zurich/Athens: Parmenides Publishing, 2011), esp. 86–89.
- 20 Guthrie, *HGP*, II, 61. Tarán, *Parmenides*, 248 and n. 50, however, disagrees.
- 21 This is why I prefer *κληροῦχον*, 'allotter', in the description of the daimon. Necessity is naturally associated with allotment.
- 22 Guthrie, *HGP*, II, 63, states that 'The descriptions of Plato and Parmenides are in a common tradition, and the only possible tradition is the Pythagorean.' But perhaps there is also an Orphic thread; see below, 1.7, 'The Orphic Tradition', 350–53.
- 23 D-K, I, 241.16–18, Parmenides B10.5–7; Clement, *Stromateis* V, 14.138.1; as quoted and translated in Barnes, *Early Greek Philosophy*, 139.
- 24 D-K, I, 237.10–11, Parmenides B8.30–31, trans. Gallop, *Parmenides Fragments*, 69.
- 25 Guthrie, *HGP*, II, 182, n.1 also points this out. Later authors such as Plutarch also assumed that *philia* was love: he calls Empedocles' love principle Aphrodite or Eros, and says desire came into nature 'from Providence' (*De facie* 926f–927a: ... ἄχρι οὗ τὸ ἱμερτὸν ἦκεν ἐπὶ τὴν

Love unites and Strife divides, and these two opposing forces join and separate the roots.

Necessity is a goddess in the *Purifications* (Καθαρμοί); she is associated with oracles and oaths, and seems to be very ancient: 'There is an oracle of Necessity, a decree of the gods long ago, eternal and sealed by broad oaths. . . .' (fr. B115).²⁶ Because Necessity forces Charis and Neikos to take turns ruling, it is hated by Charis²⁷ who, as Sandbach²⁸ says, is *philia* by yet another name (Guthrie assumes it is Love).²⁹ Though certainly Empedocles did not intend it, there is a connection, though paradoxically by hate, between love (or Charis) and Necessity. We think we are separate from the object of our hatred, but the act of hatred brings us together with it. Hate, it seems, can bind as much as love.

1.3 *Aeschylus*

By the time of Aeschylus, Zeus is no longer, as in Hesiod, the dispenser of Ananke, but rather subject to it. In *Prometheus Bound* (Προμηθεὺς δεσμώτης), not even Zeus can escape Fate/Necessity: 'Chorus: Who then is the helmsman of Necessity? Prometheus: The three-formed Fates and mindful Furies. Chorus: Can it be that Zeus is weaker than they? Prometheus: Yes, in that even he cannot escape what is fated. Chorus: But what is fated for Zeus except always to have power?'³⁰ Words like power (*kratos*) and force (*bia*) used in this way emphasise these connotations for *anankē*.

φύσιν ἐκ προνοίας, φιλόκτητος ἐγγενομένης καὶ Ἀφροδίτης καὶ Ἐρωτος ὡς Ἐμπεδοκλῆς λέγει καὶ Παρμενίδης καὶ Ἡσίοδος. . . .)

- 26 D-K, I, 357: ἔστιν Ἀνάγκης χρέμα, θεῶν ψήφισμα παλαιόν, / αἰδίων, πλατέεσσι κατεσφρηγισμένον ὄρκοις. My translation after Wright in Empedocles, *Empedocles: The Extant Fragments*, ed. and trans. M. R. Wright (New Haven/London: Yale University Press, 1981), 270. Ananke is also connected with oracles in the Orphic theogony (see below, 1.7, 'The Orphic Tradition', 351).
- 27 Fragment B116, Καθαρμοί (*Purifications*), D-K, I, 358.15: [Χάρις] στυγέει δύσκλητον Ἀνάγκην ('[Charis] hates hard-to-bear Necessity').
- 28 In Plutarch, *Quaestiones convivales*, ed and trans. F. H. Sandbach, in *Moralia*, IX (Loeb), 278, note *a*.
- 29 Guthrie, *HGP*, II, 163.
- 30 Aeschylus, *Prometheus Bound*, (Page, ll. 515–18): Χο. τίς οὖν ἀνάγκης ἐστὶν οἰακοστρόφος; / Πρ. Μοίραι τρίμορφοι μνήμονές τ' Ἐρινύες./Χο. τούτων ἄρα Ζεὺς ἐστὶν ἀσθενέστερος; / Πρ. οὐκ οὖν ἂν ἐκφύγοι γε τὴν πεπρωμένην./Χο. τί γὰρ πέπρωται Ζηνὶ πλὴν αἰὶ κρατεῖν; Note the use of 'peprōmenē', 'fated, destined' (LSJ, s.v. πόρω II.2), an adjective often applied to *Moirai*; it comes from the verb πόρω, perhaps whence comes Latin *pars*, *portio*, with the same idea of one's fate as an apportioned lot. In the Chorus's last question Ananke is juxtaposed with power (χράτος): Zeus thinks he has it, but it is Ananke which embodies that power.

Note the use of the word *oiakostrophos*, helmsman, here, to describe the task of the Moirai (and Furies). In astrology, the hour-marker (Ascendant) is called the *oiax*, rudder, of the chart,³¹ by which the native's fate is turned; it zodiacally represents the time and place where the child comes into being, manifest in the physical world and thus subject to some kind of fate. Most of the lots, whose very name prompts connection with one's allotment or fate, project from this same Ascendant.

1.4 Plato

Plato, as always, provides more grist for the mill. Certainly the two crucial dialogues for understanding Eros and Necessity are *Symposium* and *Republic* (the Myth of Er). In *Symposium*, Eros and what it might be create the structure of the dialogue.³² Diotima's exposition of Eros is the central focus, but it is preceded by Pausanias's speech about the two kinds of Eros, one earthly (Pandemos) and one heavenly (Ouranios) (180d–182a); the earthly Eros is sexual desire, corporeal and hedonistic, while the heavenly Eros is a 'rational' desire, which is pure and focused not on the body but on the soul.³³

There is an interesting juxtaposition of Eros and Necessity in Agathon's speech, when he criticises Hesiod and Parmenides for saying that Eros is the oldest god (195b–c). To make the point that Eros is the youngest, not the oldest, of the gods, Agathon points to the forceful binding and violence of the early gods as proof that this was not Eros, but Necessity. If Eros had been present, he says, there would have been not violence but harmony and peace. This viewpoint clearly echoes the ancient views of Eros as union and Ananke as force or compulsion.

Diotima's slant is different. Her Eros is the *daimōn megas* (202d13) who is, naturally, between gods and mortals. This Eros, offspring of Poros (Provision)

There may be a subtle play on words here, as *kratos* is often paired with *anankē*, and *anankē* itself represents fate.

31 See, e.g. Paulus, ch. 24 (Boer, 54.2); also Chart No. 81 (P. Lond. 130) in Neugebauer and Van Hoesen, *GH*, 22, 24, col. vii.165; and P. Oxy. No. 4277, in Jones, *APO*, vol. 2, 420.17.

32 *Symposium* 178b is a source for the Parmenides fragment cited above: 'First of all the gods she crafted Eros.' For Eros in the *Symposium*, see among others Timotin, *Démonologie*, 37–42 (and his bibliography); idem, 'Éros, le démon philosophe et la polémique anti-gnostique. Plotin lecteur du *Banquet*', in *De Socrate à Tintin. Anges gardiens et démons familiers de l'Antiquité à nos jours*, ed. Jean-Patrice Boudet, Philippe Faure, and Christian Renoux (Rennes: Presses universitaires de Rennes, 2011), 51–54. Here I only lay out those themes in *Symposium* relevant for our discussion of Eros.

33 This dichotomy may, of course, reflect Plato's prejudice against women; still, these two conceptions of love were not unique to Plato.

and Penia (Poverty), seeks wisdom, the good and the beautiful; he moves between the want of Penia and the resourcefulness of Poros. Through pursuing wisdom, the good and the beautiful, this Eros will find both happiness (εὐδαιμονία) and a kind of immortality through creation.

For Ananke, the Myth of Er (*Republic* x.616c–617d), discussed elsewhere,³⁴ is important for understanding the nature of the daimon. Plato's Ananke controls the spindle about which the cosmos revolves, and is thus intimately connected with time, space and the material world of generation. The whorls, which are the paths of the planets, move around this central spindle made of adamant (i.e. unbreakable). On the rim of each whorl a Siren stands, singing a note for her particular whorl, which harmonises with all the others. The three Moirai, daughters of Ananke, help turn the whorls around the spindle. After the souls' required choice of a daimon and a life based on the lot they have drawn (617d–621a), they pass 'beneath the throne of Necessity'.³⁵

Though the souls choose their own lives, they are paradoxically required to do so (Lachesis is, after all, Necessity's daughter). Though we are responsible for our lives (617e),³⁶ we have been forced to choose them, in the order the lots give us. In Hermetic literature (see 1.6 below) Necessity is also connected with the order of the Cosmos (the primary meaning for *kosmos*, of course, is 'order'). Here the lots enforce Necessity. In the singing of the Sirens, as well, is a link between Necessity and harmony (perhaps because it symptomises a pleasing order?).

This joining of Fate and Necessity disseminates from Plato to the Stoics to the Hermetists, and is found especially in those Hellenistic astrologers who have some connection with Egypt, including Valens³⁷ and Manetho. Manetho begins two of the books of his *Apotelesmatika* with references to the fate and necessity which rule the world.³⁸

34 See Chapter 8, 1.1.

35 *Republic* 620e–621a: ... ὑπὸ τὸν τῆς Ἀνάγκης ἰέναι θρόνον. ...

36 αἰτία ἐλομένου θεός ἀναίτιος. 'Responsibility is with the chooser; God is not responsible.'

37 I think it likely Valens visited Egypt in search of astrological knowledge (see *Anthology* IV, 11.4–9), despite the reservations of Komorowska, *Valens*, 248–59; eadem, 'The Lure of Egypt or How to Sound Like a Reliable Source', in *Astrology and the Academy: Papers from the Inaugural Conference of the Sophia Centre, Bath Spa University College, 13–14 June 2003*, ed. Nicholas Campion, Patrick Curry, and Michael York (Bristol: Cinnabar Books, 2004).

38 Manetho, *Apotelesmatika*, 1.7 (Lopilato, 24, 187): Μοιρῶν ἀρρήκτοις μίτοις θεσμοῖσι τ' Ἀνάγκης. [The mortals who are born] 'by the unbreakable threads of the Moirai and the laws of Ananke.' 1V.1–4 (Lopilato, 75, 239): Οὐρανίων ἄστρον ἀτραπούς, πλάστιγγας ἀνάγκης, / αἶψιν ἐφημερίων μερόπων γένος ἐχμεμέτρηται, / Μοιράων τε κέλευθα βροτῆσια καὶ πλάνα φέγγη / ἀπλανέων τ' αὐγὰς πυριλαμπέας ἐξονόμηνα. ... 'The paths of the heavenly stars, the scales

1.5 *Plutarch*

Plutarch compares the Sun with Eros in his essay on Love (Ἐρωτικός).³⁹ Though the two have similarities, the Sun is indicative of the sensible world because it brings us the light with which we perceive it, while Eros, on the other hand, is 'noetic' (νοητός). And because the Sun gives us the sensible world, it 'bewitch(es) us by the charm and brilliance of vision, and convincing us that truth and everything else is to be found in the sun, or in the realm of the sun...'⁴⁰

Plutarch goes on to say that truth is rather to be found in darkness and dreams, in what cannot be seen with the eyes but with the mind; and this truth, which is beauty and worth, is recognised through Love (Eros), a 'divine, chaste Love to be its physician, its saviour, its guide'.⁴¹ This description recalls the 'Heavenly Eros' of the *Symposium*, an Eros not sullied by the messiness of the body. Yet this Love does not come to the soul directly, but enters through the medium of the body. Humans first learn the physical forms of love (the passion and intoxication of the earliest meetings with the beloved), but through that come to know a different form of love, a divine love which fills the soul, so that both corporeal and spiritual love are experienced in the relationship (765a–d). Eros is therefore 'like a mystic guide beside us at our initiation'.⁴²

Eros thus represents both body and soul, in that it feeds the soul through the body.⁴³ From an astrological perspective, Plutarch's comparing Eros to the Sun is interesting, because the Lot of the Sun (i.e. the Lot of Daimon), with Aphrodite in one formula and the Lot of Fortune in another, creates the Lot of Eros prized for its power in interpretation and prediction by Vettius Valens, Firmicus Maternus, Paulus and others.

of necessity / by which the race of ephemeral mortals is measured out, / and the human tracks of the Moirai and the wandering lights / and the fire-bright beams of the fixed stars I have discussed...'. Trans. Lopilato, slightly modified. Manilius, as well, is famous for his comment 'fata regunt orbem' (*Astronomica*, 4.14).

39 Plutarch, *Amatorius*, in *Moralia*, IX, trans. W. C. Helmbold. Translations here are Helmbold's.

40 *Amatorius*, 764e, in *Moralia*, IX, 400–01:... χάριτι και λαμπρότητι τῆς ὄψεως γοητεύων και ἀναπειθῶν ἐν ἑαυτῷ και περὶ αὐτὸν κείσθαι τὰ τ' ἄλλα και τὴν ἀλήθειαν...

41 *Amatorius*, 764f, in *Moralia*, IX, 402–03:... θείου και σώφρονος Ἐρωτος ἱατροῦ και σωτήρος και ἡγεμόνος...

42 *Amatorius*, 765a, in *Moralia IX*, 402–03:... οἶον ἐν τελετῇ παρέστη μυσταγωγός.

43 Plutarch's interpretation, while echoing the earthly and heavenly Eros of the *Symposium*, puts a more positive slant on the body as a necessary conduit; without the body, Eros cannot lead the soul to truth.

1.6 *The Hermetic Tradition and the Chaldean Oracles*

Both the *Hermetica* and the Chaldean Oracles hold conceptions of Eros and Ananke. In *Asclepius*, 'Divinus Cupido' (Latin Eros) relates the Hermetic cosmogony,⁴⁴ where Eros embodies the principle of union:

For I say that the Cosmos is, in its nature, both sensation and growth, and contains growth in itself and preserves all things that have come into being. For each sex is filled with procreation, and the joining of each, or more truly, their uniting, is incomprehensible. Whether you call it Cupid or Venus, or both, you would be correct.⁴⁵

Necessity, on the other hand, is literally bound up with *Heimarmenē*, and described with many word-plays referring to chains, bonds, glue and force. This bonding creates order, which fits the Cosmos itself together. *Heimarmenē*, Necessity and Order are part of God's divine plan, and they are inexorable, swayed neither by anger nor kindness (Empedocles' strife and love?). In *SH XIII*, Necessity and *Heimarmenē* are subservient to Providence (*pronoia*); in fact, Necessity is described as a 'firm decision and unalterable power of Providence'.⁴⁶ In the *Korē Kosmou* (*Pupil of the Eye of the Cosmos*), Kronos (the planet Saturn, as one of the gods who are responsible for various parts of the human condition) calls himself the 'father of Dike and Ananke'.⁴⁷ (Is there an echo of Parmenides here?) Since Necessity is part of the structure of planetary cycles and time, perhaps the Hermetic writer is playing on the common Greek pun of *chronos/kronos*. Eros and Necessity are described as masters over the souls who are bound to bodies: 'It is Eros, O souls, and Ananke, who will be

44 *Asclepius*, Prologue, 1 (Nock and Festugière, *CH* II, 297.16). See also *Hermetica*, ed. and trans. Scott, I, 288; and *Hermetica*, trans. Copenhaver, 67.

45 *Asclepius* III, 21 (Nock and Festugière, *CH* II, 322.3–9): Ego enim et in naturam et sensum et mundum dico in se continere naturam et nata omnia conservare. Procreatione enim uterque plenus est sexus et eius utriusque conexio aut, quod est verius, unitas incomprehensibilis est, quem sive Cupidinem sive Venerem sive utrumque recte poteris nuncupare. See also Scott, *Hermetica* I, 332–35; Copenhaver, *Hermetica*, 79. My translation after Copenhaver.

46 *SH XIII* (Nock and Festugière, *CH* III, 64): Ἀνάγκη ἐστὶ κρίσις βεβαία καὶ ἀμετάτρεπτος δύναμις προνοίας. (Scott, *Hermetica* I, 434–35.)

47 *SH XXIII.28* (*Korē Kosmou*) (Nock and Festugière, *CH* IV, 9.1–2): Κρόνος ἀπήγγειλεν ἦδη πατὴρ γεγονέναι καὶ Δίκης καὶ Ἀναγκῆς. See also Scott, *Hermetica* I, 472–73.

masters over you, for after me [*the primary God, described as μόναρχος*] they are the masters and orderers of all things' in the physical world.⁴⁸

In the Chaldean Oracles, Eros (not Necessity) is a binding force which contributes to the order of the world.⁴⁹ Eros proceeds from Nous, allowing everything in the world to be connected through love, and even becomes part of the tripartite soul: '(The Father) mixed the spark of soul with two unanimous qualities, Nous and Divine Will, to which he added a third, pure Love, as the tamer and holy bond of all things.'⁵⁰

We have now seen Necessity bound with Fate, time and the planets, in threads running from Parmenides to Plato to the Hermetists and beyond. Eros, in turn, is a great creative force which joins together the beings of the Cosmos. The Orphic theogony aligns with all of these conceptions and introduces some new elements.

1.7 *The Orphic Tradition*

The way the Orphics involve Eros and Ananke in their theogony may have implications for its use and philosophical underpinning in astrology (since Orphic cults and writings were prevalent at the time when astrology was flourishing in the late Antique world).⁵¹ The earliest parts of this tradition (the Orphic poems) date to the late sixth/early fifth centuries BCE,⁵² but the Orphic Hymns are from the Imperial period⁵³ and the Rhapsodic Theogony, revered by Neo-Platonists, may date to ca. 100 BCE⁵⁴ (though the Orphic theogony itself survives in far older versions).

48 SH XXIII.38 (Nock and Festugière, *CH* IV, 12.11–12, 15–17): "Ἐρως ὑμῶν, ψυχαί, δεσπόσει καὶ Ἀνάγκη, οἶδε γὰρ μετ' ἐμέ πάντων δεσπότηαι τε καὶ ταξίαρχοι. . . . θνητοῖς καὶ αὐταὶ προσμεμοιρασμένον χῶρον σπλάγγνοις καταδικασθεῖσαι ἐνοικήσετε. See also Scott, *Hermetica* I, 478–79. My paraphrase of the second part here excerpted.

49 Frs 39, 42, 44 (Majercik). See Lewy and Tardieu, eds, *Chaldaean Oracles and Theurgy*, 126–29.

50 Fr. 44 (Majercik, 66–67): '... ψυχαῖον σπινθήρα δυσὶν κράσας ὁμοιοίαις, / νῶ καὶ νεύματι θεῖῳ, ἐφ' οἷς τρίτον ἄγρον ἔρωτα, / συνδετικὸν πάντων ἐπιβήτορα σεμνόν, ἔθηκεν.' Trans. Majercik, modified. See her notes, 160–61, 218 (*sub* Fr. 216).

51 See L. Greene, 'Did Orphic Beliefs Influence the Development of Hellenistic Astrology?' *Culture and Cosmos* 9.2 (2005): 21–45.

52 West, *Orphic Poems*, 7.

53 *Ibid.*, 1.

54 *Ibid.*, 226.

The main parts of the theogony are these:⁵⁵ Earth and Water are (perhaps—there is disagreement here) the first principles. From them are born Chronos/Herakles, a serpent with the heads of a bull and a lion, with a god's face in the middle; and Necessity who is called Adrasteia (the 'inescapable'), whose form is both male and female 'as a sign that she was the cause of bringing all things to birth.'⁵⁶ Thus both Time and Necessity are involved with generation (see my discussion of the caduceus below).

Chronos has three offspring: Aither, Chaos and Erebos; and in Aither, Chronos creates an Egg. This Egg splits (the halves may form heaven and earth) to reveal Phanes, whose name literally means 'shining one' and 'appearance'.⁵⁷ Phanes is the creator of all: he is beautiful, he shines with light, has golden wings and heads of various animals. He contains both sexes (since he will create everything from himself). He is known by several different names: Protogonos (first born), Erikepaios, Metis, Dionysus and Eros. Among his creations is his daughter Night, who becomes his partner in creation and to whom he gives the gift of prophecy (she gives oracles from a cave, and Adrasteia [= Ananke] stands at the entrance to the cave). Night bears Gaia and Ouranos, leading to the Titans and Olympians as in the standard mythological tradition. Yet rather than cede to a new order, in Orphism Night remains a powerful and important counsellor: when Zeus swallows Phanes and becomes in his turn the creator of all, Night advises him.⁵⁸

55 For this recitation I follow the descriptions of W. K. C. Guthrie, *Orpheus and Greek Religion: A Study of the Orphic Movement* (London: Princeton University Press, 1952; reprint, 1993), 79–83; this is the Hieronyman Theogony.

56 Damascius, *De principiis*, i.318.5–6 (Ruelle, vol. 1, 318.5–6): ... ἀρσενόθηλυν αὐτὴν ὑπεστήσατο πρὸς ἔνδειξιν τῆς πάντων γεννητικῆς αἰτίας. Also Kern, *OF*, 131.1–2, Fragment 54 (also cited in Guthrie, *Orpheus*, 101). Damascius describes the Hieronyman Theogony (see West, *Orphic Poems*, 178–79, for his translation of Damascius's entire passage).

57 Myths of the cosmos arising from an egg which splits open are not uncommon in other Mediterranean cultures; for instance, in Phoenician cosmogony heaven and earth are formed from an egg, and in Zoroastrian, Ahura Mazda creates a material heaven in the form of an egg (see West, *Orphic Poems*, 103–06). In the Khonsu cosmogony, Amun-Ptah creates and fertilises an egg from which the Ogdoad comes: see E. Cruz-Uribe, 'The Khonsu Cosmogony', *JARCE* 31 (1994): 169–89. In another Egyptian cosmology, e.g., the Cenotaph of Seti I at Abydos (M. Clagett, *Ancient Egyptian Science: A Source Book*, 3 vols., vol. 2 (Philadelphia: American Philosophical Society, 1995), 399) and the Book of Nut (Fundamentals of the Course of the Stars) (von Lieven, *Grundriss des Laufes der Sterne*, 158–59), Geb (Earth) and Nut (Sky) are separated by Shu (air) so that their separation may produce life. See also G. Thomson, 'From Religion to Philosophy', *JHS* 73 (1953): 77–83, here 77 and n. 7.

58 See Guthrie, *Orpheus*, 106–07.

The Orphic Hymns (dating to the early centuries CE)⁵⁹ propitiate all of these divinities, along with other, astrologically important, deities: some represent parts of the Cosmos,⁶⁰ while others have the same names as astrological lots, including Victory (*Nikē*), Nemesis, Eros, Necessity, Fortune (*Tuchē*) and Daimon (*Daimōn*) (only Courage [*tolma*] does not appear).⁶¹

Both Guthrie and West⁶² have noticed links between the Orphic theogony and Egyptian, Phoenician, Babylonian and Zoroastrian mythologies, as well as Mithraism,⁶³ and Neo-Platonists such as Porphyry, Proclus and Damascius (the last Neo-Platonist) portrayed or interpreted it.⁶⁴

What are the roles of Eros and Ananke in this theogony? Ananke is the axis of the cosmos⁶⁵ and a winged serpent twining around the universe with Chronos, Time.⁶⁶ Eros (a.k.a. Phanes) comes winged, gleaming and golden from an egg, and creates the immortals: ‘... the longed-for Eros, back gleaming with golden wings...’⁶⁷ (this image is especially beloved by the Neo-Platonists).⁶⁸ The word

59 See West, *Orphic Poems*, 29; *The Orphic Hymns: Text, translation and notes*, ed. and trans. Apostolos N. Athanassakis (Missoula, MT: Scholars Press for the Society of Biblical Literature, 1977), vii–viii; *The Orphic Hymns*, trans., intro. and annot. Apostolos N. Athanassakis and Benjamin M. Wolkow (Baltimore: The Johns Hopkins University Press, 2013).

60 As West, *Orphic Poems*, 36, points out: ‘Direct invocation of parts of the cosmos is on the whole a phenomenon of the Imperial Age.’

61 Those of astrological and cosmological interest include Night (3), Ouranos (4), Aither (5), Protogonos (6), the Stars (7), Sun (8), Moon (9), Herakles (12), Kronos (13), Rhea (14), Zeus (15), Earth (26), Hermes (28), Nike (33), Horai (43), Aphrodite (55), Eros (58), Moirai (59), Graces (60), Nemesis (61), Dike (62), Tyche (72), Daimon (73). Adrasteia is mentioned in the Proem, as are Chronos and Pronoia. See Appendix 10.A for the hymns to Eros, Tyche and Daimon.

62 Guthrie, *Orpheus*, 98, 113, 170, 177, 198, 254–56; West, *Orphic Poems*, 101–07; see also M. L. West, *Early Greek Philosophy and the Orient*, esp. 28–36.

63 See below, ‘Caduceus Redux’, 385 and Fig. 10.13, for a connection between Mithraism and Orphism.

64 See West, *Orphic Poems*, 229.

65 Just as she controls the spindle about which the cosmos revolves in the Myth of Er, and is the daimon placed in the middle of the cosmic bands in Parmenides.

66 Damascius, *De principiis*, i.318.1–4. See below, n. 76.

67 Aristophanes, *The Birds* (Coulon), ll. 695–696: Ἔρως ὁ ποθεινός, / στίλβων νῶτον πεπερόγειον χρυσαῖον (cited in West, *Orphic Poems*, 111–12). The shining gold colour suggests a possible link to the sun (see Plutarch’s comments on the Sun and Eros above, 1.5, 348); Charles Burnett (personal communication) pointed out the literal golden yellow of the egg yolk. There may also be a connection between Eros coming forth from the egg, whose two halves may represent heaven and earth (or even sun and moon?), and the planet/goddess Venus whose Greek name was ‘Phosphoros’ (light bringer).

68 Guthrie, *Orpheus*, 93.

used for the gleaming wings is *'stilbōn'*, the astrological name of Hermes.⁶⁹ In a relief from Modena of the second century CE, Phanes-Protagonos is winged and wrapped round by a serpent, surrounded by the signs of the zodiac.⁷⁰ This Orphic theogony connects Eros, Ananke and, perhaps obliquely, Hermes, since his astrological name, *'stilbōn'*, is used here.⁷¹ But something else connects Eros, Ananke and Hermes astrologically, namely the caduceus, whose description by Macrobius we quoted at the beginning of this chapter.

1.8 *Intermezzo: The Caduceus*

Macrobius knows his Orpheus⁷² as well as his astrology.⁷³ His descriptions of the caduceus and the four 'deities' which 'preside over a man's birth' are suspiciously the same as our astrological lots of Fortune, Daimon, Eros and Necessity. Are there connections between the caduceus and the Orphic theogony's Eros and Ananke? And why does Vettius Valens specifically privilege these lots?⁷⁴ Some answers may lie in Orphic material.

West points out that both Athenagoras, a Christian apologist of the second century CE, and Damascius, the last Neo-Platonist, associated Herakles with 'the winged serpent Chronos'⁷⁵ in addition to associating Ananke with Chronos-Herakles.⁷⁶ Damascius, of course, is later than both Valens and Macrobius, but

69 For more about 'light' names ascribed to the planets, see Greenbaum, 'Rising to the Occasion: Appearance, Emergence, Light and Divination in Hellenistic Astrology', 13. See also F. Cumont, 'Les noms des planètes'; and A. Jones, 'The Keskintos Astronomical Inscription: Text and Interpretation', *Sciamus* 7 (2006): 3–41, here 16–17.

70 In M. J. Vermaseren, *Corpus inscriptionum et monumentorum religionis Mithriacae*, 2 vols. (The Hague: M. Nijhoff, 1956–1960), here vol. 1, No. 695; also in West, *Orphic Poems*, Plate 6; Guthrie, *Orpheus*, Plate 12; Gundel and Gundel, *Astrologumena*, Tafel 8. Whether the relief is actually an Orphic artefact, or a Mithraic representation, the birth of Phanes from an egg is an Orphic concept.

71 In addition to Aristophanes, *στίλβων* and similar words describe Phanes (a.k.a. Eros) in Kern, *OF*, Fr. 86.4, 158 (quoted in Proclus and Damascius). The common uses of *στίλβων* are to describe gold, the stars and other heavenly bodies and, particularly, the planet Mercury.

72 See *Saturnalia* I, 17.42, 18.12–22, 23.22; *Commentary on the Dream of Scipio*, I, 12.12.

73 See n. 3.

74 Valens does not mention a caduceus or a Heracleian knot in his lot descriptions, but one wonders where he got the formulae that link Eros and Ananke with Fortune and Daimon, and considers them important enough that they are classed with the best, most operative places in the chart and included in profectioes.

75 West, *Orphic Poems*, 192; see also 193–94, 231, 252.

76 *Ibid.*, 194. The text, cited by West, is Damascius, *De principiis*, i.318.1–4 (Ruelle). To alleviate some difficulties with the text and West's rendition (see his 178, 194), I am following

the Orphic theogony was well known long before that time. Contemporary with Valens, Athenagoras wrote an account of the Orphic theogony in his *Plea for the Christians*, ca. 177 CE.⁷⁷ It contains a passage very similar to Macrobius's description of the knot of Hercules in the caduceus. Athenagoras tells us that Zeus desired to mate with his mother/sister Rhea-Demeter. She resisted and '... became a serpent (*drakōn*)⁷⁸ and he, changing into a serpent himself, [and] binding her in the so-called Heracleian knot, had intercourse with her (the wand of Hermes is a token⁷⁹ of the figure of the intercourse).'⁸⁰ Athenagoras's statement aligns well with Macrobius' description of the caduceus; could it have been a source for him?

Athenagoras and Damascius have their own common source⁸¹ in an Orphic Theogony (described above) ascribed by Damascius to 'Hieronymus'; it incorporates elements of an earlier Protogonos Theogony with 'Stoic embellishment', so West dates it after the second half of the third century BCE.⁸² For the connection between Chronos and Herakles, West cites Cleanthes as the

the version of L. G. Westerink in Damascius, *Traité des premiers principes*, ed. L. G. Westerink, trans. Joseph Combès (Paris: Les Belles Lettres, 1991), 161.7–11. The text and my translation: ... ὠνομάσθαι δὲ Χρόνον ἀγήραον καὶ Ἡρακλῆα τὸν αὐτόν· συνείναι δὲ αὐτῷ τὴν Ἀνάγκην, φύσιν οὖσαν τὴν αὐτὴν καὶ Ἀδράστειαν, δισώματον διωργυριωμένην ἐν παντὶ τῷ κόσμῳ, τῶν περάτων αὐτοῦ ἐφαπτομένην. '... named unaging Time (*Chronos*) and Herakles also; together with him was Ananke, and Adrasteia being of the same nature, double-bodied, stretching her arms out over the whole cosmos, holding fast over its limits.' ἐφάπτω is a fate word, meaning in active voice 'to bind or fix as one's fate'; in middle voice it can mean 'claim as one's property'.

77 Athenagoras, *Legatio pro Christianis*, ed. Miroslav Marcovich (Berlin/New York: De Gruyter, 1990), vii.

78 Δράκων probably comes from δέркоμαι, to perceive, see clearly—not just sight, but sharp sight (from its Sanskrit root); LSJ s.v. For etymology see also Ogden, *Drakōn*, 173 and n. 157. The snake or serpent is, of course, an ancient symbol of wisdom.

79 Σύμβολον contains the sense of its original meaning, that of a token in which the two halves can only have their meaning realised when they are brought together. See my discussion of *symbolon* in 'Rising to the Occasion', 12.

80 Athenagoras, *Legatio*, XX.2 (Marcovich, 61.18–20): ... δρακαίνης δ' αὐτῆς γενομένης καὶ αὐτὸς εἰς δράκοντα μεταβαλὼν <καὶ> συνδήσας αὐτὴν τῷ καλουμένῳ Ἡρακλειωτικῷ ἄμματι ἐμίγη (τοῦ σχήματος τῆς μίξεως σύμβολον <δν> ἢ τοῦ Ἑρμοῦ ῥάβδος)... Quoted in West, *Orphic Poems*, 194–95; West's translation, 195, which I have followed in part.

81 West, *Orphic Poems*, 180.

82 Ibid., 224, 226. Evidence of Stoic influence (219–26) would certainly be congenial to astrological principles. We may have a Stoic component syncretizing with the Orphic, which then came into Hellenistic astrology.

source of a Stoic allegory connecting Herakles’ labours and cosmic time.⁸³ The entwined Chronos and Ananke may be ‘conceived . . . as symbolizing the vertical axis about which the world . . . revolved.’⁸⁴

An interesting parallel between knots, time and the zodiac appears in Aratus, *Phaenomena* 239–45, which connects knots and the vernal point in the ‘knot of the heavens’ (mentioned also by Cicero and Hyginus).⁸⁵ The knot of heaven (α Piscium) connects the two fish, and is the place where the ecliptic, equator and colures meet at the very end of Pisces, between it and the beginning of the zodiac in Aries.⁸⁶ So Necessity, who turns the spindle of time in the Myth of Er, is also the knot in the caduceus; and the knot of heaven, as a *sundesmos*⁸⁷ (a bond), marks the heavenly point at which the year begins. Both knots evoke the shared task of Chronos and Ananke.

Vettius Valens, as well, was not ignorant of Orpheus:

[12] And as the most divine Orpheus says:

A human soul is rooted in aither.

[13] And in another way:

When drawing in air we pluck a divine soul.

[14] In another way:

A deathless and ageless soul is from Zeus.

[15] In another way:

The soul of all is deathless, but the bodies mortal.⁸⁸

83 Ibid., 194 and n. 56.

84 Ibid., 198, where he adds: ‘It is logical enough that Time should be at the centre of the heavens. . . . It is equally logical that Ananke should be there (as in Plato and perhaps Parmenides) to maintain the strict regularity that those heavens display.’

85 Hyginus, *De astronomia*, III, 29; Cicero, *Aratea*, fr. 33.17. See G. de Callataÿ, ‘The Knot of the Heavens’, *JWI* 59 (1996): 1–13, esp. 1–6, who suggests this knot was the vernal point in antiquity.

86 De Callataÿ, ‘Knot of the Heavens’, 3. See also Aratus, *Phaenomena*, ed. and trans. Douglas Kidd, (Cambridge: Cambridge University Press, 1997), 270–71.

87 Σύνδεσμος ὑπουράνιος. *Sundesmos* in astrology, the joining of two bodies, e.g. the Moon to the Sun, or the Moon or Sun to other planets, is of great importance in astrological interpretation.

88 Valens, IX, 1.12–15 (Pingree, 317.19–26 [= Kern, *OF*, 244, Fr. 228]): καθὼς καὶ ὁ θεϊότατος Ὀρφεὺς λέγει·

ψυχὴ δ’ ἀνθρώποισιν ἀπ’ αἰθέρος ἐρρίζωται. καὶ ἄλλως·

ἀέρα δ’ ἔλκοντες ψυχὴν θεῖαν δρεπόμεσθα. ἄλλως·

ψυχὴ δ’ ἀθάνατος καὶ ἀγήρωσ ἐκ Διὸς ἐστίν. ἄλλως·

ψυχὴ δ’ ἀθάνατος πάντων, τὰ δὲ σώματα θνητά.

Given that, in an important predictive method, Valens uses the very lots mentioned in the caduceus of Macrobius (in what methods we will see next), and that he was clearly acquainted with some Orphic literature, it is possible that his astrological use of Eros and Necessity arose in part from his knowledge of the Orphic tradition.⁸⁹ Valens also appears to be the earliest astrological author to use and interpret these particular lots. We turn now to the Lots of Eros and Necessity in the astrological tradition.

2 The Astrological Lots of Eros and Necessity

The Lot of Fortune, as we have seen, was almost universally employed by Hellenistic astrologers (even the cause-minded Ptolemy). The Lot of Daimon, as well, is also regularly found in extant examples of Hellenistic-style charts. Eros and Necessity are among the planetary lots in Antiochus/Rhetorius (Paulus), Paulus and Olympiodorus: the former called Venus's lot and the latter Mercury's. But the Lots of Eros and Necessity are given a special role to play by authors such as Vettius Valens and Firmicus Maternus. What distinguishes these two lots from their planetary siblings? The following examination will provide possible reasons for their exceptionality.

2.1 *The Lots of Eros and Necessity in Astrological Literature*

Valens' techniques employ these lots more than any other astrologer's surviving works. In 11, 16, our four Macrobian lots are singled out among the names for various places of the chart:

The God gives signs about the father, Goddess about the mother, Good Daimon about children, Good Fortune about marriage, Evil Daimon about illnesses, Bad Fortune about injuries, the Lot of Fortune and the Hour-marker about life and manner of living, [the Lot of] Daimon about intentional mind (φρόνησις), Midheaven about action, [the Lot of] Eros about desire, [the Lot of] Necessity about enemies.⁹⁰

89 Komorowska, *Valens*, 319–24, suggests Valens obtained his Orphic knowledge from the *Hermetica*, but she does not discuss it in reference to his lot usage.

90 Valens, 11, 16.1 (Pingree, 67.5–9): Ὁ μὲν θεὸς σημαίνει περὶ πατρός, ἡ δὲ θεὰ περὶ μητρός, ἀγαθὸς δαίμων περὶ τέκνων, ἀγαθὴ τύχη περὶ γάμου, κακὸς δαίμων περὶ παθῶν, κακὴ τύχη περὶ συνῶν, κλήρος τύχης καὶ ὠροσκόπος περὶ ζωῆς καὶ βίου, ὁ δαίμων περὶ φρονήσεως, μεσουράνημα περὶ πράξεως, ἔρωσ περὶ ἐπιθυμίας, ἀνάγκη περὶ ἐχθρῶν. Including lots with places seems to equate them in importance.

We saw in Chapter Nine that Valens uses the Lots of Fortune and Daimon as releasers in finding time-lords for particular periods of life. In Book IV, the places where the four lots fall are called ‘operative and active’.⁹¹ In his subsequent coverage of profections, he includes the four lots as profecting places, describing in detail the resulting outcomes for each (we have already seen those for Fortune and Daimon). For Eros and Necessity, he says:

[5] Eros handing or taking over in profitable places, and with benefics in them or witnessing, furnishes desires with a good moral purpose and lovers of beautiful things. For some are turned toward education and bodily or musical training and, being softened up with pleasure in future hope, they believe in foresight (*pronoia*) as untiring; but some, being beguiled by sexual pleasures and intimacies both with women and men, believe it good. [6] And so Ares and Hermes bearing witness [*i.e. aspecting*] or being in the place, and especially in their own zodiac signs, make lovers of boys, or they are censured for both,⁹² or they are those who love arms, hunting and wrestling; but [if] Aphrodite [is in such a condition], [she makes] sexual intimacies with women. And so sometimes also, since they have been shown affection, they show affection back. [7] And likewise, each of the stars when it has been allotted the place, either bearing witness or taking over the time, will furnish the form (*eidōs*) of the desire according to its own nature. [8] And so generally when malefics are in them or witnessing, the things associated with the desire will come to be by extortion, penalty and danger. [9] And if in any way the [star] of Kronos is co-present with or bears witness to Aphrodite and the Moon, they are blamed for the love of licentious deeds both with men and women, and they endure scandals or, having repented (*metanoēō*),⁹³ are indifferent when conquered by suffering. [10] If in any way the [star] of Zeus is co-testifying, the result will happen in a trustworthy or powerful way, or mystically. [11] When Ares and Hermes are in them or bearing

91 Valens, IV, 11.49 (Pingree, 167.20–23): χρηματιστικά μὲν οὖν καὶ ἐνεργητικά ζώδια ἔστιν ὠροσκόπος, μεσουράνημα, ἀγαθὸς δαίμων, ἀγαθὴ τύχη, κληρὸς τύχης, δαίμων, ἔρωσ, ἀνάγκη· μέσα δὲ θεός, θεὰ καὶ τὰ λοιπὰ δύο κέντρα· μέτρια δὲ καὶ κακωτικά τὰ λοιπὰ. ‘The operative and active zodiac signs are the Hour-marker, Midheaven, Good Daimon, Good Fortune, the Lots of Fortune, Daimon, Eros and Necessity; middling are God, Goddess and the remaining two centrepins; but the rest are barely sufficient and malefic.’ Note that the lots’ power is seen as equal to that of the Ascendant, Midheaven, Good Daimon (the 11th) and Good Fortune (the 5th).

92 I think this means censured for both kinds of sexual preference.

93 More literally, ‘change one’s mind’.

witness, or taking over the time, [they make] the love of wicked and shameful affairs; for they come to be forgers, robbers, burglars, gamblers, with the thinking faculty of a wild beast. [12] And if the [star] of Aphrodite also bears witness, [it makes] poisoners, adulterers, murderers, from which, being involved in evil works with securities and loans, in accordance with the times which are occurring, having the experience of imprisonment or judgement, they live dangerously. <For> the place is actually powerful (*ischuros*) in many [areas], which is why one must take it into consideration.⁹⁴ . . .

[14] Necessity handing or taking over in operative places, when benefics are in them or witnessing, brings on affiliations and alliances with superiors, and the subjugations or deaths of enemies. [15] When malefics are in them, it brings on litigations and trials, and payments [for them], from which, in accomplishing their purpose, they live wretchedly. And if the figure is afflicted in any way, some are condemned or subjugated.⁹⁵

-
- 94 Valens, IV, 25.5–12 (Pingree, 191.27–192.22): [5] Ὁ ἔρωσ παραδιδοῦς ἢ παραλαμβάνων ἐν χρηματιστικῶν τόποις, καὶ ἀγαθοποιῶν ἐπόντων ἢ μαρτυροῦντων, εὐπροαιρέτους ἐπιθυμίας κατασκευάζει καὶ καλῶν ἔραστᾶς· οἱ μὲν γὰρ περὶ παιδείαν καὶ ἀσκησιν σωματικὴν ἢ μουσικὴν τρέπονται καὶ μεθ' ἡδονῆς κολακευόμενοι τῇ μελλούσῃ ἐλπίδι ἀκοπίαστον ἡγούνηται τὴν πρόνοιαν, οἱ δὲ ἀφροδισίοις καὶ συνηθείαις θελχθέντες θηλυκῶν τε καὶ ἀρρενικῶν ἀγαθῶν ἡγούνηται. [6] Ἄρης μὲν οὖν καὶ Ἑρμῆς ἐπιμαρτυρήσαντες ἢ ἐπόντες τῷ τόπῳ, καὶ μάλιστα ἐν ἰδίῳ ζῳδίοις, παιδεραστᾶς ποιοῦσιν ἢ ἐπ' ἀμφοτέροις ψογίζονται ἢ φιλόπλους τε καὶ φιλοκυνήγους καὶ φιλοπαλαίστρους, Ἀφροδίτῃ δὲ θηλυκῶν συνηθείας· ἔσθ' ὅτε μὲν οὖν καὶ στερχθέντες ἀντιστέργουσιν. [7] ὁμοίως δὲ καὶ ἕκαστος τῶν ἀστέρων ὁ κεκληρωμένος τὸν τόπον ἢ ἐπιμαρτυρῶν ἢ παραλαμβάνων τὸν χρόνον κατὰ τὴν ἰδίαν φύσιν τὸ εἶδος τῆς ἐπιθυμίας κατασκευάσει. [8] καθόλου μὲν οὖν κακοποιῶν ἐπόντων ἢ μαρτυροῦντων, ἐπὶ βασάνῳ καὶ ζημίᾳ καὶ κινδύνῳ τὰ τῆς ἐπιθυμίας γενήσεται. [9] ἐὰν δὲ πῶς ὁ τοῦ Κρόνου σὺν τῷ τῆς Ἀφροδίτης καὶ τῇ Σελήνῃ συμπάρῃ ἢ ἐπιμαρτυρήσῃ, αἰσχροῶν καὶ ἀσελγῶν ἔργων ἐρώσιν, ἐπὶ τε ἀρρενικῶν καὶ θηλυκῶν ψογίζονται καὶ περιβοησίας ὑπομένουσιν ἢ μετανοοῦντες ἀνεπιστρεπτοῦσιν ὑπὸ τοῦ πάθους νικῶμενοι. [10] ἐὰν δὲ πῶς ὁ τοῦ Διὸς συνεπιμαρτυρήσῃ, ἀξιοπίστως ἢ δυνατῶς τὸ γενόμενον ἔσται ἢ μυστικῶς. [11] Ἄρεως δὲ καὶ Ἑρμοῦ ἐπόντων ἢ ἐπιμαρτυροῦντων ἢ παραλαμβανόντων τὸν χρόνον, κακούργων πραγμάτων ἢ ληστρικῶν ἐρώσιν· γίνονται γὰρ πλαστογράφοι, ἀρπαγες, θυρεπανόικται, κυβευταί, τεθριωμένην τὴν διάνοιαν ἔχοντες. [12] ἐὰν δὲ καὶ ὁ τῆς Ἀφροδίτης ἐπιμαρτυρήσῃ, φαρμακοί, μοιχοί, αὐτόχειρες, ὅθεν κατὰ τοὺς ἐπιβάλλοντας χρόνους ἐγγύαις καὶ δάνεσι περικυλιόμενοι καὶ κακούργιαις, συνοχῆς ἢ κρίσεως πείραν λαμβάνοντες ἐπικινδύνως διάγουσιν· ἰσχυρὸς <γὰρ> ὁ τόπος πρὸς πολλὰ ὑπάρχει, ὅθεν αὐτῷ προσεκτέον. . . .
- 95 Valens, IV, 25.14–15 (Pingree, 192.25–30): Ἀνάγκη παραδιδοῦσα ἢ παραλαμβάνουσα ἐν χρηματιστικῶν τόποις, ἀγαθοποιῶν ἐπόντων ἢ μαρτυροῦντων, οἰκειώσεις μὲν ἐπάγει καὶ μειζῶνων συστάσεις καὶ ἐχθρῶν καθαιρέσεις ἢ θανάτους· κακοποιῶν δὲ ἐπόντων, ἀντιδικίας καὶ

Firmicus also mentions these lots and their formulae in *Mathesis*, Book VI, but gives little in the way of interpretation. I discuss his formulae below.

For Paulus and Olympiodorus, the Lot of Eros is Aphrodite's lot, and the Lot of Necessity is Hermes's. They say of them: 'Eros signifies appetites and desires occurring by choice, and it becomes responsible for friendship and favour. Necessity signifies imprisonments, subordinations, battles and wars, and it makes enmities, hatreds, condemnations and all the other constraining circumstances which happen to men as their lot at birth.'⁹⁶

In Hephaestio, the Lot of Eros is used in synastry⁹⁷ between friends, and in the *Liber Hermetis* for synastry between parents:

Hephaestio, On Friends and Enemies:

Let us also set out again the things which have been said very well by Dorotheus. Others, he says, look upon the Lot of Eros, namely how it lies [in the chart], by what stars it is beheld (θεωρεῖται), and they examine with [this lot] the things concerning friendship. . . . And the equally-ascending zodiac signs are sympathetic to one another, especially if the Lots of Eros of the two nativities should fall in them.⁹⁸

Liber Hermetis, On Parents:

It is also proper to take note of the Part of Cupid,⁹⁹ if it is configured to the Sun <and> Moon, especially by trine and sextile, and if they are

κρίσεις ἐπάγει καὶ ἐξοδιασμούς, ὅθεν καὶ περὶ προαίρεσιν διαπράξαντες ἀνιαρῶς διάγουσιν. ἐὰν δὲ πῶς τὸ σχῆμα κακωθῆ, τινὲς καταδικάζονται ἢ καθαιροῦνται.

96 Paulus, ch. 23 (Boer, 50.1–7) (Olympiodorus has virtually the same wording, ch. 22 [Boer, 57.5–10]): 'Ὁ δὲ Ἔρως σημαίνει τὰς ὀρέξεις καὶ τὰς ἐπιθυμίας τὰς κατὰ προαίρεσιν γινομένας, φιλίας τε καὶ χάριτος παραίτιος καθέστηκεν.

Ἡ δὲ Ἀνάγκη συνοχὰς καὶ ὑποταγὰς καὶ μάχας καὶ πολέμους, ἔχθρας τε καὶ μῖσος καὶ καταδικὰς καὶ τὰ ἄλλα πάντα τὰ τοῖς ἀνθρώποις συμβαίνοντα βίαια πράγματα ἐν γέννῃ ποιεῖ. See also Greenbaum, *Late Classical Astrology*, 42, 108.

97 The astrological term for making a comparison between the charts of two people.

98 Hephaestio, II, 23.10–11, 16 (Pingree, 183.17–20, 184.3–5): 'Ἐκκείσθω δὲ πάλιν καὶ τὰ παρὰ Δωροθέω σφόδρα καλῶς εἰρημένα. ἄλλοι δέ, φησίν, ἐπιβλέπουσι τὸν κλήρον τοῦ ἔρωτος, δηλονότι πῶς κείται, ὑπὸ ποιῶν ἀστέρων θεωρεῖται, καὶ <πρὸς> αὐτὸν τὰ περὶ φιλίας σκοποῦσιν. . . . καὶ τὰ ἰσανάφορα δὲ ζῴδια συμπαθῆ ἔστιν ἀλλήλοισι, μάλιστα ἐὰν τῶν δύο γενέσεων οἱ κλήροι τοῦ ἔρωτος ἐμπέσωσιν εἰς αὐτά.

99 'Partem Cupidinis' in Dorotheus (Pingree, 433) and W. Gundel, *Neue astrologische Texte des Hermes Trismegistos. Funde und Forschungen auf dem Gebiet der antiken Astronomie und Astrologie* (Munich: Verlag der Bayerischen Akademie der Wissenschaften, 1936), 48.14–16; but 'partem cupidinis' (with a lower-case 'c') in Feraboli, *Hermetis Trismegisti: De triginta sex decanis*, 73.41–44.

in obedient signs,¹⁰⁰ for then <we say> they mutually appreciate each other.¹⁰¹

(Note that both quotations are said to be from Dorotheus.) Additionally, in Hephaestio's book on katarchic astrology, the four lots are used to interpret a *katarchē*:

The composed *katarchē* points out each [part of the ritual] before the opening of the animal: the Hour-marker reveals the one making the sacrifice; the Setting [place] that which is sacrificed or the sacrificial victim; the Midheaven the god or gods; the Underground [place] the reason for the altar,¹⁰² the completion of the matter and how it is sacrificed. One must carefully consider the stars—in what places they are, their position and phase, and the four lots—Fortune, Daimon, Necessity, Eros.¹⁰³

The question we must ask now is: why these four lots? What do they have in common, that they are grouped together and considered worthy of being used in so many types of astrology—natal, predictive and katarchic? The answer may appear obvious, but the development of the tradition has been surprisingly difficult to illuminate.

2.2 *A Double Tradition?*

The formulae given by Paulus and reiterated by Olympiodorus were not the only formulae available for these lots in the ancient world.¹⁰⁴ We will now look

100 Obedient signs are Scorpio, Sagittarius, Capricorn, Aquarius and Pisces; they obey, respectively, the commanding signs of Virgo, Leo, Cancer, Gemini and Taurus. (See Paulus, ch. 9; also Appendix I.A, Fig. 1.3.)

101 Dorotheus (Pingree, 433): 'Oportet etiam observare partem Cupidinis, si configuratur ad Solem et Lunam maxime per trinum et sextilem, et si sunt in signis oboedientibus; tunc enim <dicimus> quod diligunt se ad invicem'. The same in *Liber Hermetis*, ch. 21, 13 (ed. Feraboli, 73.41–44), with slight variation: 'Oportet etiam observare partem cupidinis, si configuratur ad Solem et Lunam maxime per trinum et sextilem, et si sunt in signis oboedientibus; tunc enim <significant> quod diligunt se ad invicem.'

102 I.e., why a sacrifice is needed.

103 Hephaestio, III, 6.11 (Pingree, 253.20–254.4): 'Αποδείκνυσι δὲ ἕκαστα πρὸ τῆς ἀναπτύξεως τοῦ ζώου διατεθεῖσα ἢ καταρχή, καὶ μὴνύουσιν ὁ μὲν ὠροσκόπος τὸν θύοντα, τὸ δὲ δῶνον τὸ θυόμενον ἢ τὸ ἱερεῖον, τὸ δὲ μεσουράνημα τὸν θεὸν ἢ τοὺς θεούς, τὸ δὲ ὑπόγειον τὴν τῆς ἐστίας αἰτίαν καὶ τὴν ἔκβασιν τοῦ πράγματος καὶ δι' ὃ θύεται· τοὺς τε ἀστέρας ἐπιθεωρητέον ἐν οἷς γέ εἰσι τόποις καὶ ἀξίαι καὶ φάσει καὶ τοὺς τέσσαρας κλήρους—τύχης, δαίμονος, ἀνάγκης, ἔρωτος. See below, 366–67, for more on this passage.

104 See Appendix 10.B for a listing of all the lot formulae described in this section.

at the parameters of all these lots. For Paulus's Lot of Eros (associated with Venus), one takes the arc, in a diurnal chart, from the Lot of Daimon to Venus, and projects the same amount from the Ascendant, reversing this formula for a nocturnal chart (Figure 10.2). Thus the following formula (stated slightly differently, but with the same result):

$$\text{Asc} + \text{Venus} - \text{Daimon (D)} \quad \text{or} \quad \text{Asc} + \text{Daimon} - \text{Venus (N)}$$

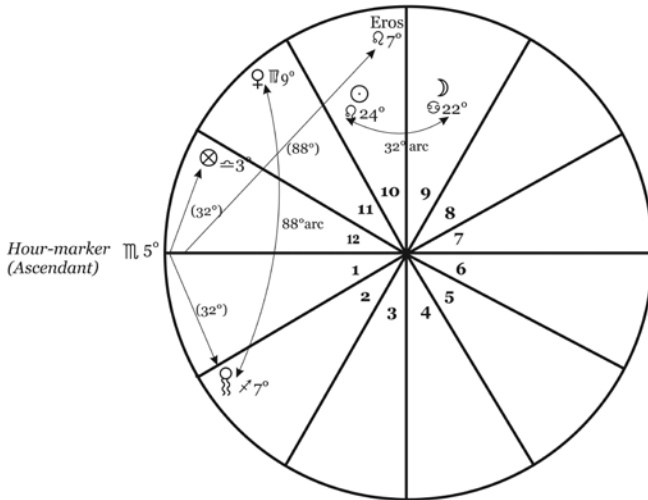

FIGURE 10.2 Paulus's Lot of Eros in a diurnal chart.

For Paulus's Lot of Necessity, one uses the arc from Mercury to Fortune by day and from Fortune to Mercury by night (Figure 10.3), or:

$$\text{Asc} + \text{Fortune} - \text{Mercury (D)} \quad \text{or} \quad \text{Asc} + \text{Mercury} - \text{Fortune (N)}$$

These are the lot formulae cited as the ones in common practice in the Hellenistic astrological world by most of the scholars in this under-studied corner of the field.¹⁰⁵ Yet was this truly common practice? In examining the literature, especially the extant examples of birthcharts, it is clear there is another set of formulations for these lots, using the arcs between the Lots of Fortune and Daimon and projecting from the Ascendant. In the literature, these formulae are given by Firmicus, and by Vettius Valens, but each author gives formulae which reverse the other's.

105 Bouché-Leclercq, *AG*, puts the 'Hermetic' lots in a table within the text (307–08) and cites Paulus for them, while mentioning Firmicus's formulae for the *locus cupidinis* and *necessitatis* only in a footnote (306, n. 6) as part of the multitude of diverse lots that, in

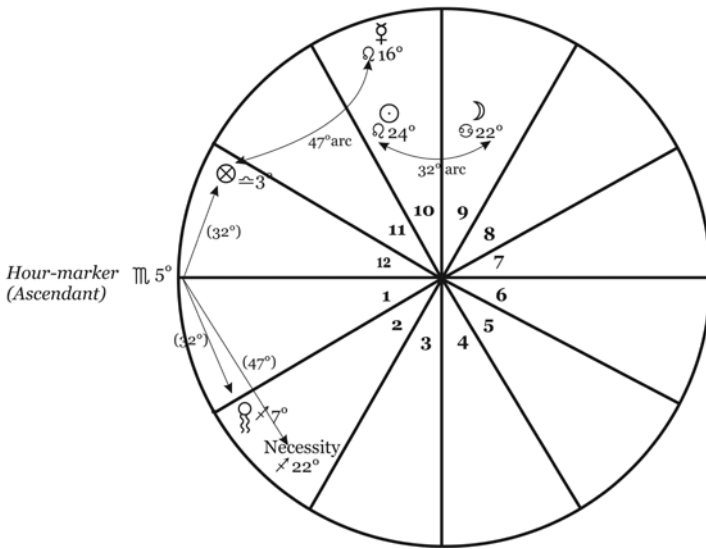

FIGURE 10.3 Paulus's Lot of necessity in a diurnal chart.

In *Mathesis* VI Firmicus gives the formulae for a number of lots, including those of 'Desire' (*Cupido*) and 'Necessity' (*Necessitas*), equated respectively with the Greek Eros and Ananke. For the '*locus Cupidinis*', Firmicus says:

his usual sarcastic style, he characterises as (306) 'une série qui pourrait être prolongée au-delà des bornes de la patience humaine.' Neugebauer and Van Hoesen, *GH*, 9, treat the Paulus formulae as authoritative, though 'no example of this procedure is preserved in the extant horoscopes'. F. Gettings, *The Arkana Dictionary of Astrology* (London: Arkana/Penguin Books, 1985, repr. 1990), 180, 233–34, 288–89, 338, 455, 479, mentions only the Paulus/Hermetic formulae for the Lots of Eros and Necessity. Tester, *A History of Western Astrology*, 28–29, mentions a few lots, but gives no lot formulae except the Lot of Fortune. He claims the calculation of the lot was '... variously described by different authorities, some of whom seem to be not at all clear about what they are doing' (28). (I would say rather than being unclear, astrologers supported one tradition or another.) T. Barton, *Ancient Astrology* (London/New York: Routledge, 1994), 98–99, 123 mentions some of the lots, but provides no formulae. She notes Paulus's description of the Hermetic lots (81). Holden, *A History of Horoscopic Astrology*, 76–78, quotes the Paulus excerpt mentioning the lots and their formulae; provides summaries of the books of Firmicus in detail (71–74), but does not include any lot formulae for Firmicus's Eros or Necessity. Alone among historians of astrology, Giuseppe Bezza devotes an entire chapter of *AM* (vol. 2, 963–1012) to the lots, giving an etymology of *klēros*, formulae and examples of the lots, and even discussing possible philosophical implications (some of these will be taken up later). The non-Paulus formulae for the Lots of Eros and Necessity are on p. 969.

On the place of Cupid and desires. If you want to find the place of desires by degree¹⁰⁶ compute, in a diurnal nativity, from the degree of Daimon to the degree of Fortune, and as much from the Horoscope (Ascendant). But in a nocturnal [nativity], you will compute by the same methods <from> Fortune to Daimon, and as much from the Horoscope, and when you have got the place reckoned by degree (*partili ratione*), every appetite for desires will be demonstrated to you from the sign and from the testimonies of the stars. But by what reckoning you may find the place of Fortune and Daimon, we have said in the fourth book.¹⁰⁷

Thus:

Asc + Fortune – Daimon (D) or Asc + Daimon – Fortune (N)

For the '*locus necessitatis*', Firmicus says:

On the place of necessity. If you wish to find the place of necessity by partile reckoning, you will compute in a diurnal nativity from Fortune to Daimon, in a nocturnal nativity from Daimon to Fortune, and as much from the Horoscope, and when you have got this same place by that same reckoning, you will determine all the things about this place by the quality of the signs and the stars.¹⁰⁸

106 'Partiliter'. This word, the adverbial form of *pars*, here has the technical astrological meaning 'by degree' (not 'partially').

107 VI.32.45 (Ksz, II, 187.3–12 = Monat, III, 125): 'De loco Cupidinis et desideriorum. Locum desideriorum si partiliter volueris invenire, in diurna quidem genitura a parte Daemonis usque ad partem Fortunae computa, et tantum ab horoscopo. In nocturna vero <a>Fortuna usque ad Daemonem simillimis rationibus computabis, et tantum ab horoscopo, et cum locum partili ratione collegeris, ex signo et ex stellarum testimoniis omnis tibi desideriorum cupiditas demonstrabitur. Sed locum Fortunae et locum Daemonis qua ratione invenias, in quarto diximus libro.' Unlike Manilius, who often uses the word 'sors', and later writers in Latin who use the word 'pars' for a lot, Firmicus says 'the place of Fortune' (*locus Fortunae*).

108 VI.32.46 (Ksz, II, 187.13–19 = Monat, III, 126): 'De loco necessitatis. Si necessitatis locum partili volueris invenire ratione, in diurna quidem genitura a Fortuna computabis ad Daemonem, in nocturna vero a Daemone ad Fortunam, et tantundem ab horoscopo, et cum hunc eundem locum ista ratione collegeris, omnia de eo loco pro signorum et pro stellarum qualitate definies.' Monat (126) has translated this wrongly as the 'lieu de l'amitié'.

Thus:

Asc + Daimon – Fortune (D) or Asc + Fortune – Daimon (N)

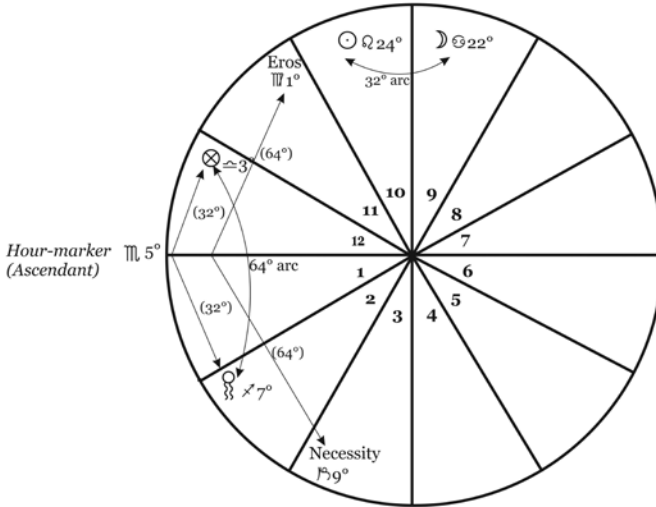

FIGURE 10.4 Firmicus's Lots of Eros and Necessity in a diurnal chart.

Valens' formulae are as follows: 'The Lot of Eros is taken by day from the Lot of Fortune to the [Lot] of Daimon and an equal amount from the Hour-marker, but by night the reverse.' And: 'Take [the Lot of Necessity] from Daimon to Fortune, but by night the reverse.'¹⁰⁹ Valens' formulae came into the early

109 Valens, IV, 25.13 (Pingree, 192.22–24): λαμβάνεται δὲ ὁ κλήρος τοῦ ἔρωτος ἡμέρας μὲν ἀπὸ τοῦ κλήρου τῆς τύχης ἐπὶ τὸν τοῦ δαίμονος [Ϛ in Ms. S] καὶ τὰ ἴσα ἀπὸ τοῦ ὥροσκόπου, νυκτὸς δὲ τὸ ἀνάπαλιν. Valens, IV, 25.16 (Pingree, 192.30–31): λάμβανε δὲ ἀπὸ δαίμονος [Ϛ in S] ἐπὶ τύχην, νυκτὸς δὲ τὸ ἀνάπαλιν. In Kroll's edition of Valens (who also used Ms. S), 202.11–14, 21–22, these formulae are presented in the text without square brackets. In *CCAG* V/2, 113.4–6, 12–13, also edited by Kroll in 1906, the formulae again are not bracketed. But in Pingree's edition of Valens, the formulae are presented within square brackets. I do not know why Pingree did this (he gives no hint in the *apparatus criticus* for this section), since Valens gives formulae for every other lot he uses. Charles Burnett, who inspected Pingree's microfilm of Ms. S (the only one extant for this portion of the *Anthology*) reports that there is no change in the hand of the copyist, nor any indication this is not part of the original text. I have now inspected the original manuscript 'S' at Oxford (Oxon. Seld. 22 [Arch. Selden. B. 19], fol. 88r) and can see no difference in the hand, nor any other distinctions between the other text on this page and the text which gives the formulae for the Lots of Eros and Necessity.

Arabic astrology of Abū Ma'shar,¹¹⁰ Al-Qabīṣī¹¹¹ and al-Bīrūnī¹¹² and continued into the medieval world in the works of authors such as Ibn Ezra¹¹³ and Guido Bonatti.¹¹⁴ These are the reverse of Firmicus's: instead of going from Daimon to Fortune by day for the Lot of Eros, this formula goes from Fortune to Daimon, thus:

Asc + Daimon – Fortune (D) or Asc + Fortune – Daimon (N)

For the Lot of Necessity, the formula is by day from Daimon to Fortune, and by night from Fortune to Daimon (the reverse of the Lot of Eros formulae), thus:

Asc + Fortune – Daimon (D) or Asc + Daimon – Fortune (N)

-
- 110 Abū Ma'shar, *The Abbreviation of the Introduction to Astrology: together with the medieval Latin translation of Adelard of Bath*, ed. and trans. Charles Burnett, Keiji Yamamoto, and Michio Yano (Leiden/New York: E. J. Brill, 1994), 71, ch. 6, 6 and 8 (hereafter *Abbreviation 1*); also Abū Ma'shar, *The Abbreviation of the Introduction to Astrology*, trans. Charles Burnett, annot. Charles Burnett et al. (Reston, VA: ARHAT, 1997), 42, ch. 6, 6 and 8 (hereafter *Abbreviation 2*); also Abū Ma'shar al-Balkhi, *Liber introductorii maioris*, vol. v, ed. Lemay, 332, Tractate VIII, Differentia tercia: Pars Veneris, Pars Mercurii, ll. 420–449 (hereafter *Greater Introduction*). In the new edition of the *Great Introduction* by Yamamoto and Burnett, forthcoming, see VIII, 3.15–16 for the lots of Venus and Mercury.
- 111 Al-Qabīṣī, *The Introduction to Astrology*, eds Burnett, Yamamoto, Yano, 141–42, ch. 5, 4–5 (Eros is called the 'lot of love and affection', also 'lot of firmness, survival', and Necessity the 'lot of poverty and lack of means').
- 112 al-Bīrūnī, *The Book of Instruction in the Elements of the Art of Astrology*, trans. R. Ramsay Wright (London: Luzac & Co., 1934), 283.
- 113 See A. Ibn Ezra, *The Beginning of Wisdom (Reshit Hochma)*, trans. Meira B. Epstein (Reston, VA: ARHAT, 1998), 141, ch. 9 (called the lots of Venus and Mercury); also idem, *The Beginning of Wisdom: An Astrological Treatise*, trans. Raphael Levy (Baltimore, MD: The Johns Hopkins Press, 1939), 224–25 (note that Levy has translated the Hebrew word [*goral*] for what would be 'lot' in Greek, or 'part' in Latin, as 'fate'). The same formulae for these lots, called the lots of Venus and Mercury, also appear in A. Ibn Ezra, *Abraham Ibn Ezra: The Book of Reasons. A Parallel Hebrew-English Critical Edition of the Two Versions of the Text*, ed. and trans. Shlomo Sela, (Leiden/Boston: Brill, 2007), 244 (Hebrew), 245 (English), *Te'amim II*, ch. 7.1.10–11. See also idem, *The Book of Reasons (Sefer Ha'te'amim)*, trans. Meira B. Epstein (Berkeley Springs, WV: Golden Hind Press, 1994), 60 (the 'lot of Mercury'; the lot of Venus is missing in this translation).
- 114 See G. Bonatti, *De astronomia tractatus x* (Basle: n.p., 1550), Tractate Four (= Book 8), Part 2, Chapter 2, col. 631. This edition online at http://hardenberg.jalb.de/display_dokument.php?elementId=5257 (accessed 11 April 2015), see Seite 882.

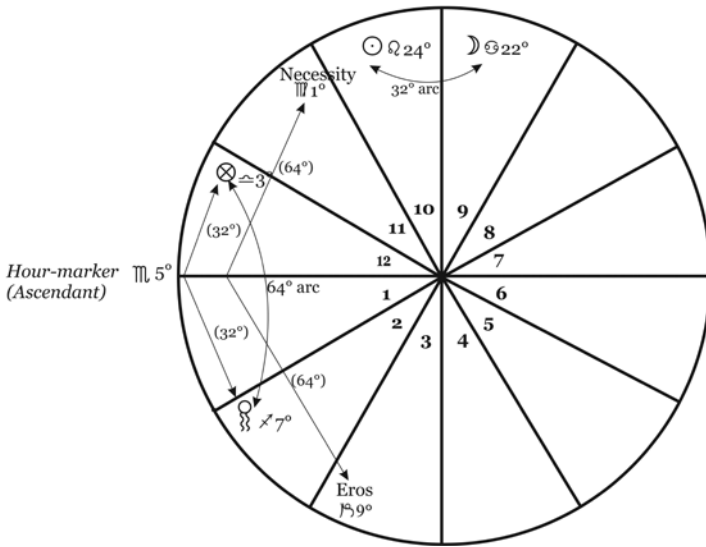

FIGURE 10.5 Valens' Lots of Eros and Necessity in a diurnal chart.

Now that we have ascertained the different formulae for these lots, what is the evidence for the use of the Lots of Eros and Necessity in extant charts of the late Classical and Byzantine eras? More importantly, which formulae do they use, since we have seen two different systems described in the literature (the one using the arc between Fortune and Daimon has two variants). Let us call one of these systems or traditions Hermetic, since it purports to be from the book of Hermes Trismegistus called *Panaretus*,¹¹⁵ as described by Paulus and Olympiodorus. The other tradition we will call 'Egyptian' (with variants), one variant according to Valens (and Abū Ma'shar, al-Birūnī etc.) and the other to Firmicus. The reason I call this latter tradition 'Egyptian' is because we have evidence that there was awareness of two traditions in antiquity, and one was described as being from the Egyptians, as in this tantalising sentence in a Scholion to Hephaestio, Book III 6, 11:¹¹⁶

That for every *katarchē* one must observe the 4 lots—Fortune, Daimon, Necessity, Eros. And it is hard to decide whether to cast out [the Lots of]

115 See Paulus, ch. 23, 'On the Seven Lots in the Panaretus' (Boer, title 47.13–14, formulae 48.13–20); also Paulus in Greenbaum, *Late Classical Astrology*, 41–42.

116 Note this scholion is a gloss on Hephaestio's use of the four lots in katarchic astrology (III, 6.11), given above, 2.1, 360 and n. 103.

Necessity and Eros according to Hermes Trismegistus or just as, in the 4th book, Dorotheus gives an account of the opinion of the Egyptians. . . .¹¹⁷

There are four extant examples using the Lots of Eros and Necessity with the Egyptian formulae, dating from ca. 138 CE to 905 CE. Two more may use the Hermetic formulae, but one is in very bad condition and one appears in a text which is not strictly Hellenistic.¹¹⁸ A new chart was recently discovered by Alexander Jones (P. Berlin 9825) which at this time is the only chart of Late Antiquity to calculate the seven 'planetary' lots according to the Paulus formulae.¹¹⁹ The four extant 'Egyptian' charts use both variants of the Egyptian formulae (two use Valens and two use Firmicus). These will now be explored in detail.

2.3 *The Lots in Action: Examples*

Our first chart, from *Greek Horoscopes*, is No. 138/161 (P. Princeton 75),¹²⁰ probably dating to 138 CE. (See Appendix 10.C for complete details of this chart and subsequent ones mentioned in this section.) Unfortunately, all the planetary positions and most of the angles are lost. The first preserved line says '21 [degrees], house of Kronos, bounds of Aphrodite';¹²¹ the text then lists our four lots and their positions, along with a brief description of each lot's significance:

2. [The] Lot of Fortune was found in Cancer, 13 degrees, house of [the]
3. Mo[on, bound]s of Hermes. This signifies a measure of fortune.
4. [The L]ot of Daimon was found in Capricorn, 27 degrees, house
5. [of Kronos, bounds of Are]s. This signifies the habit of character and conduct.
6. [The Lot of] Eros was found in Taurus, 4 degrees, house and bounds of
7. [Aphrodite. This signif]ies what concerns friendship and association.
8. [The Lot] of Necessity was found in Aries, 6 degrees, house of Ares,

117 Dorotheus, Scholium ad Heph. III 6, 11 (Pingree, 433.14–434.1): "Ὅτι ἐπὶ πάσης καταρχῆς δεῖ τοὺς δὲ κλήρους θεωρεῖν—τύχης, δαίμονος, ἀνάγκης, ἔρωτος. καὶ ἄπορον πότερον κατὰ τὸν Τρισμέγιστον Ἑρμῆν δεῖ τὴν ἀνάγκην καὶ τὸν ἔρωτα διεκβάλλειν ἢ καθὼς ἐν τῷ δ' βιβλίῳ Δωρόθεος ἱστορεῖ τὴν τῶν Αἰγυπτίων δόξαν. . . . The 'opinion of the Egyptians' the scholiast describes does not appear in the Pahlavi/Arabic version of Dorotheus's Book 4.

118 For the first, see Olympiodorus (Boer, 59.8–15). For the second, see Abū Ma'shar, *De revolutionibus nativitatium* (Pingree, 126.24–132.7).

119 With many thanks to Alexander Jones for allowing me to cite this chart here.

120 Neugebauer and Van Hoesen, GH, 44–45.

121 *Ibid.*, 44.

9. [bounds of Zeus. Th]is signifies what concerns enemies and every kind of
10. [misfortune]...¹²²

From the remaining text and the positions of the lots, Neugebauer and Van Hoesen have been able to figure out the angles of the chart as $\approx 20^\circ$ for the Ascendant and $\approx 21^\circ$ for the Midheaven; the chart is nocturnal.¹²³

The position of the lots in the chart visually shows the symmetry from the Ascendant for all four lots.

This proves the lots were calculated using the Egyptian formula. Since it is a night chart, we can tell from the positions of the Lots of Eros and Necessity that it is using the Firmicus variant of the Egyptian formula (Eros = Asc + Daimon - Fortune; Necessity = Asc + Fortune - Daimon). This chart may be the earliest extant example using these lots.¹²⁴

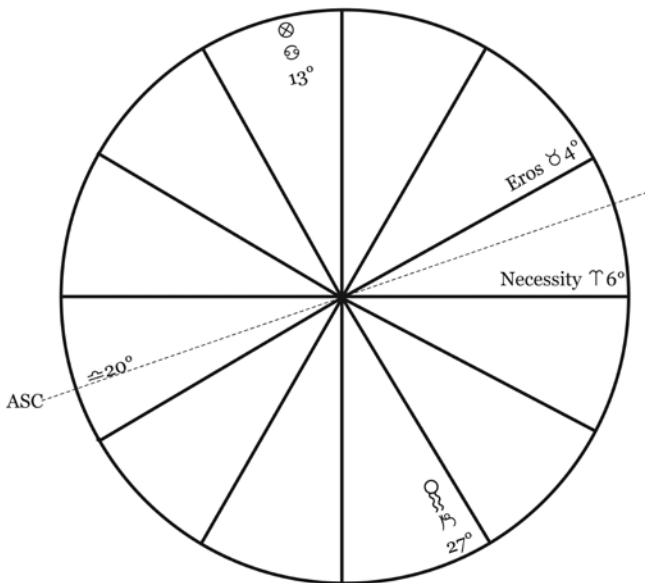

FIGURE 10.6 *Chart no. 138/161, Greek Horoscopes, nocturnal chart.*

¹²² Ibid.

¹²³ The last line of the text says it is cast for the '7th hour of night' (ibid.).

¹²⁴ If the 138 CE date is correct. Another chart with these lots, No. 4277, in Jones, *APO*, is undatable from the information given, though Jones (vol. 1, 284) suggests late 2nd or early 3rd century CE.

The second chart is also from *Greek Horoscopes* and is dated 338 CE.¹²⁵ It is much more complete, giving the owner of the chart (one Hermesion), the date and time of the chart, the planetary positions and the four lots. As in the first chart, the house lord and bound lord are included with the positions; it additionally adds the decan. It too is a nocturnal chart. Unfortunately, there are transcription errors (in antiquity). The degrees of the Sun and Moon as discerned in the text are impossible as degrees (50 and 35 respectively). The position of the Lot of Eros, given as Sagittarius 15°, is impossible based on the other lot positions. Some of the house and bound lords also do not match with the lot positions.

Here is the pertinent portion of the chart:¹²⁶

13. Lot of Fortune in Virgo, 29¹²⁷ degrees / 27. house of Hermes, bounds of Kronos, decan 3.
14. Lo[t] of Daimon in Gemini, 20 degrees / 28. House of Zeus[!], bounds of Aphrodite, decan 2.
15. Lo[t] of Eros in Sagit[tari]us, 15 degrees / 29. House of Ares[!], bounds of Hermes, decan 2.
16. Lo[t] of Necessity in T[aurus], 10 degrees 9 minutes / 30. House of Hermes[!], bounds of Ares, decan 3.

Neugebauer and Van Hoesen made a valiant effort to make sense of all this. They suggested positions for the Sun and Moon which fit with the text. Since they knew the Ascendant position (δ 13°), they could see that the arc from the Ascendant to the Lot of Fortune was 46 degrees, and they modified, correctly, the position of the Lot of Daimon from II 20° to II 27°, so that both lots are equidistant in both directions from the Ascendant.

If Fortune and Daimon are 46 degrees from the Ascendant, then Eros and Necessity must be double that, or 92 degrees from the Ascendant. The position of Necessity at v 10°09' is close to that, at 92°51' from the Ascendant. Adding 92° to the Ascendant position at δ 13° in the other direction (zodiacal motion, or counter-clockwise) obtains m 15°, the position at which Neugebauer and Van Hoesen also arrive. These positions are all consistent with each other, and with those

¹²⁵ Neugebauer and Van Hoesen, *GH*, 65–67.

¹²⁶ *Ibid.*, 65. Neugebauer informs us (66) that lines 19–30 continue lines 5–16; I have therefore placed them with their appropriate line.

¹²⁷ Editors have put $\chi\theta$ in the text, 65, but a note says they read (and translate, 66) $\chi\epsilon$. '29' is more probable astrologically.

though parts of the chart are missing, they are almost certainly the Lots of Fortune, Daimon, Eros and Necessity. This chart too is nocturnal. The relevant portions are:

- Fr. 1, col. ii Lot of Fortune
 The first lot, called for-
 15 tune, was found making its [motion] according to longitude
 in the [f]em[in]ine,
 human-formed zodiac sign Virgo [at] [7?] de(grees)
 xx min(utes) [of] the [s]ixty, [house of Her-]
 mes, its own exaltation [c. 10 letters]
 depression of Aphrodite [c. 6 letters]
 20 bounds of Aphrodite, monomoiria of Her[m]es
 in section 4, in step x,
 west [wi]nd, decan 1.
 L[ot of Daim]on
 The second [lot called] Dai-
 25 mon was found making [its motion according to longitude]
 [in the solid, royal
 [sign] Leo in [xx de(grees)], 16 [min(utes) of the] sixty,
 house [of the Sun, trigon of Zeus, with
 participation [of Ares, bounds of ?],
 30 monomoiria of [?, in section x],
 in step [x, in wind ? ...],
 decan 1.
 [Lot of Eros?]
 The thi[rd] lot, that of Eros, was found]
 35 [making] its [motion according to longitude]
 Fr. 1, col. iii in the femin[n]e, human-formed] zo[diac sign]
 Virgo (*traces*)
 3-5 (*traces*)
 6 ... west wind, [...
 Lot [of necessity]
 [The] fourth l[ot, called]
 [n]ecessit[y] was found [making] its [motion according to
 longitude
 (*no further traces visible*)

Jones's commentary, based on the evidence of the bounds, decans and monomoiria, suggests that the Lot of Fortune probably falls around 7° Virgo which, with an Ascendant of δ 22°11', would place the Lot of Daimon also 15° from

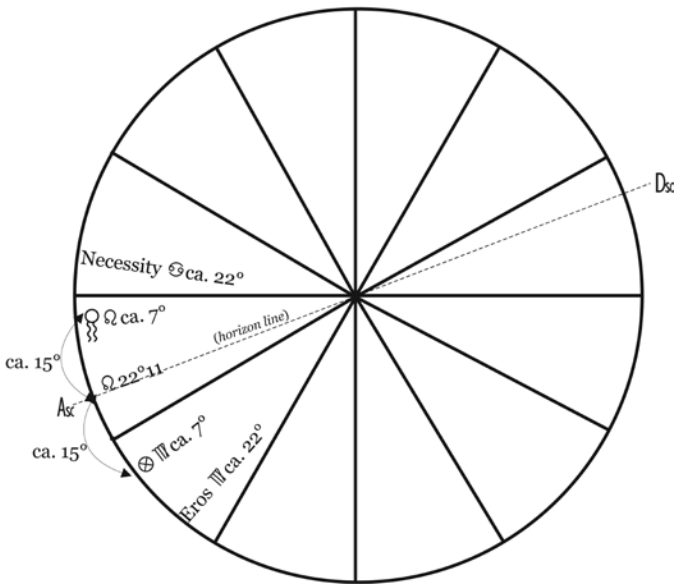

FIGURE 10.8 Chart no. 4277, *Astronomical Papyri from Oxyrhynchus*, nocturnal chart.

the Ascendant in the opposite direction (in diurnal motion, or clockwise), at about 7° Leo.

The third lot listed is presumed to be Eros (since there is textual evidence that the fourth lot is Necessity [*Anankē*]), and it is in the sign of Virgo. If the 7° figure is correct for Fortune and Daimon (about 15° from the Ascendant), then the Lot of Eros will fall at around 22° Virgo, and thus the Lot of Necessity will form the other end of the symmetry at 22° Cancer. Since this is a nocturnal chart, the formulae used must be those of Valens, where Eros = Asc + Fortune – Daimon, and Necessity = Asc + Daimon – Fortune.

Our fourth chart is not, strictly speaking, 'Hellenistic', since it dates to 905 CE, in the Byzantine era. However, since the interpretation accompanying it is entirely Hellenistic in flavour (there are frequent references to Ptolemy and Dorotheus), and it uses the Lot of Eros, it may be considered a 'neo-Hellenistic' chart. It is the birthchart of the Emperor Constantine VII Porphyrogenitus, and one of its values (apart, of course, from its obvious worth as an example of thorough interpretation using Hellenistic methods) is its quotations of Dorotheus which do not appear in the Pahlavi/Arabic versions of the *Carmen Astrologicum*. Especially useful is the employment and interpretation of a number of lots within the chart: Fortune, Daimon, Livelihood (*bios*), Marriage,

Friendship, Eros and Military Service. David Pingree did a critical edition and commentary in 1973.¹³¹

Our investigation will be limited to the Lots of Fortune, Daimon and Eros. Since all the planetary positions, angles and lots are given in more detail in this manuscript than in the previous charts here examined, it is easier for us to duplicate what the astrologer did when he drew up the chart. Figure 10.9 shows, in chart form, the information given:

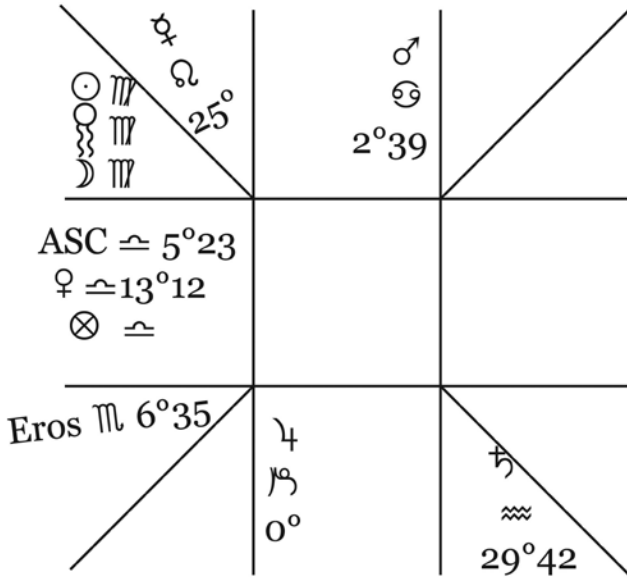

FIGURE 10.9 *Nativity of Constantine VII Porphyrogenitus, text positions of planets, angles and lots.*

We know that the Ascendant is $\approx 5^{\circ}23'$ [IV.3, p. 223], the Lot of Fortune is in Libra in the first house (with Venus) [VIII.1–2, p. 225], the Lot of Daimon is in Virgo with the Moon [III.2, p. 223], the Lot of Eros is at $\text{♁ } 6^{\circ}35'$ [XIV.3, p. 228] and the Sun and Moon are both in Virgo and cadent (Moon in Virgo, ‘emerging and making bodily separation from the Sun’ [V.1.3–4, p. 224]; Sun and Moon cadent [IV.1.2–3, p. 223]). The chart is diurnal. In a diurnal chart, the Lot of Fortune will take its arc from Sun to Moon and thence from the Ascendant in

131 D. Pingree, ‘The Horoscope of Constantine VII Porphyrogenitus’, *Dumbarton Oaks Papers* 27 (1973): 217 + 219–31.

the same direction. The Lot of Daimon diurnally is the arc from Moon to Sun and thence from the Ascendant in the same direction. Since the Lot of Fortune is in Libra, and the Lot of Daimon in Virgo, the Sun must be earlier in zodiacal longitude than the Moon.

By examining how the Byzantine astrologer calculated the Lot of Eros, we can see that he was using the Firmicus formula for a diurnal chart, by day from Daimon to Fortune, thus $\text{Asc} + \text{Fortune} - \text{Daimon}$.¹³² We can further ascertain the probable degrees of the Sun and Moon. As stated in the text, the Ascendant is $\underline{\text{a}} 5^{\circ}23'$ and the Lot of Eros is $\text{m}_{\text{L}} 6^{\circ}35'$. Using the Daimon/Fortune formulae for the Lot of Eros, we know that Eros is twice the distance from the Ascendant as the Sun is from the Moon. The distance between the Ascendant and Eros is $31^{\circ}12'$. Half of that is $15^{\circ}36'$. (This is the arc between the Sun and the Moon, the Ascendant and Fortune, and the Ascendant and Daimon.) We know that the Sun and Moon are both in Virgo, the Lot of Fortune is in Libra¹³³ and the Lot of Daimon is in Virgo. If we add $15^{\circ}36'$ to the $\underline{\text{a}} 5^{\circ}23'$ Ascendant, we get $\underline{\text{a}} 20^{\circ}59'$; this is the Lot of Fortune. If we subtract $15^{\circ}36'$ from the $\underline{\text{a}} 5^{\circ}23'$ Ascendant, we get $\text{m}_{\text{P}} 19^{\circ}47'$; this is the Lot of Daimon. If we plug in the Firmicus diurnal formula for the Lot of Eros ($\text{Asc} + \text{Fortune} - \text{Daimon}$), using these figures, we add $\underline{\text{a}} 5^{\circ}23'$ and $\underline{\text{a}} 20^{\circ}59'$ ($185;23 + 200;59 = 385;83$). Then we subtract $\text{m}_{\text{P}} 19^{\circ}47'$ ($385;83 - 169;47 = 216;35$) and get the exact figure given in the text: $\text{m}_{\text{L}} 6^{\circ}35'$! The Sun and Moon must, then, be $15^{\circ}36'$ apart. Let us assume that the Moon is as close to the end of Virgo as it can be, $\text{m}_{\text{P}} 29^{\circ}59'$. If we subtract $15^{\circ}36'$ from that, we get $\text{m}_{\text{P}} 14^{\circ}23'$, or the 15th degree of Virgo for the Sun (as Pingree states).¹³⁴

132 Pingree found the degree of the Lot of Daimon retroactively from the position of the Lot of Eros, yet the way he has calculated it agrees neither with the precise position of the Lot of Eros, nor his own reckoning about the arc between the Sun and the Moon. One problem is that Pingree was using an incorrect formula for the Lot of Eros: he states it 'is computed from the lot of the demon (which is in Virgo; see III.2), Mercury and the ascendent' (*ibid.*, 221). I have found no ancient text giving such a formula. The usual formulae are the ones I have called Hermetic and Egyptian and none ever involves Mercury. I think that Pingree, mistakenly, was able to get a position close to the Lot of Eros by using the formula of $\text{Asc} + \text{Mercury} - \text{Daimon}$. Using Pingree's position for the Lot of Daimon, which he takes as 26° Virgo, and the chart position of Mercury at 25° Leo, he arrives at $\text{m}_{\text{L}} 6^{\circ}23'$, which is certainly close to $\text{m}_{\text{L}} 6^{\circ}35'$. Yet I believe I have ascertained exactly how the Lot of Eros was computed by the Byzantine astrologer. See above, this paragraph.

133 It is with Venus, 'its own House-master' (VIII.2.6; p. 225), and Venus is in Libra in the Ascendant.

134 Pingree, 'Constantine', 220. (In actuality, the Moon had just moved into Libra, but we will continue as if it were still in Virgo, to accord with the interpretations of the Byzantine astrologer.)

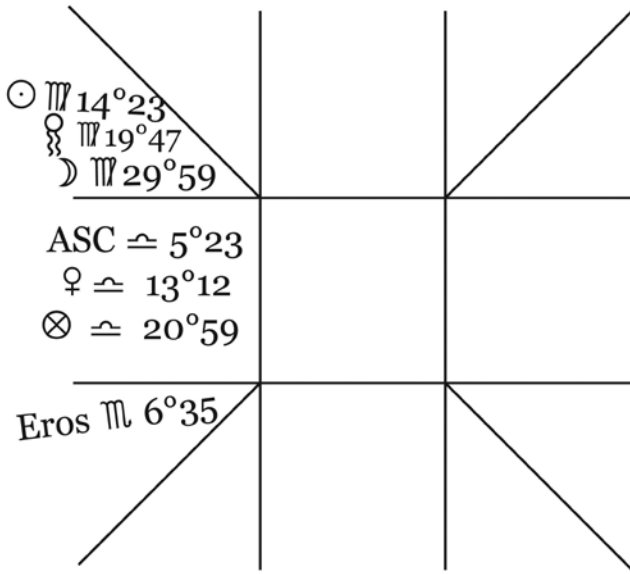

FIGURE 10.10 *Nativity of Constantine VII Porphyrogenitus, calculated positions of Sun, Moon, Lots of Fortune and Daimon based on textual clues. Diurnal chart.*

This chart, with its lengthy interpretation, tells us that even well into the Byzantine era some astrologers were still using relatively pure Hellenistic techniques in their chart analysis.¹³⁵

What of the three charts which use the Hermetic formulae? Compared to the ones using Egyptian formulae, two are later in time (presuming that the example in Olympiodorus was not calculated earlier than 564 CE and that Abū Ma'shar will be after 825 CE)¹³⁶ than probably three of the other four charts,¹³⁷ and Abū Ma'shar's work is not strictly Hellenistic, since the work in which this chart appears, *De revolutionibus nativitatū*, mentions the Persian techniques

135 There is a Byzantine era katarthic chart in *CCAG VIII/1*, 253–55, which mentions the four lots Fortune, Daimon, Eros and Necessity; but only the Lot of Fortune is calculated, and none of the lots are interpreted. The rest of the interpretation seems to be in the Hellenistic vein, however.

136 See D. Pingree, 'Abū Ma'shar Al-Balkhī, Ja'far ibn Muhammad', in *Dictionary of Scientific Biography*, vol. 1, ed. C. C. Gillespie (New York: Scribner, 1970), 32–39, here 33.

137 We can assume that *APO* #4277 is prior to 564 CE, when the Olympiodorus commentary was written.

of directing the Ascendant as 'Zamoktar', as well as the technique of Firdar.¹³⁸ The newly-discovered chart of 319 CE is the only clear example of the Paulus formulae in antiquity. Here is a short summary of each of these charts.

P. Berlin 9825 is now one of the most complete extant charts we possess. Although the first part of the papyrus roll is missing (which would probably have included the name, date and time of the chart, and the Sun's position), Jones has reconstructed the date from the other planetary and lot positions. All seven Paulus lots, with their longitude (sign, degree, minute) are given, along with the lords of the sign and bounds of each lot. Much other astrological and astronomical data is also provided.¹³⁹

The chart in Olympiodorus appears in the midst of a list of lot formulae. The text is extremely corrupt.¹⁴⁰ What we can ascertain is that the Lot of Fortune is at 17° Capricorn, the Lot of Daimon is at 22° Gemini and the Lot of Eros is at 12° Gemini. The shorter arc between Fortune and Daimon is 155°; the longer arc 205°. Since the Ascendant must be equidistant from these positions, the Ascendant must either be ♎ 4°30' or ♎ 4°30'. That being the case, if we are calculating them with Egyptian formulae, the Lots of Necessity and Eros must be (in the case of a ♎ 4°30' Ascendant) ♎ 29°30' or ♎ 9°30'; or (in the case of a ♎ 4°30' Ascendant) ♎ 29°30' or ♎ 9°30'. None of these corresponds to the Lot of Eros stated in the text as 12° Gemini. Therefore we can conclude that the Egyptian formula, in either variant, is not being used. We cannot conclude for certain that the Paulus formula for Eros is being used (because we do not know the position of Venus), but it is possible.¹⁴¹

The chart in Abū Ma'shar's *De revolutionibus nativitatū* gives complete and accurate chart positions.¹⁴² To determine the Lots mentioned in the text, including the Hermetic Lot of Necessity, the following positions are given: Sun at ♌ 15°57', Moon at ♎ 12°43', Ascendant at ♎ 2°54', Mercury at ♌ 22°07', Mars at ♌ 10°29' and Jupiter at ♎ 20°26'.¹⁴³ (Mercury and Jupiter are both retrograde, but this will not affect the lot calculation.) This is a nocturnal chart, so the

138 Abū Ma'shar, *De rev. nat.*, for Zamoktar, III, 1 (Pingree, 126.3–6, 129.10, 20); for Firdar, I, 5, 8; IV, 1–7 (Pingree, 15.3–7, 24.3–7, 181–206).

139 This information comes from Jones's notes, which he has very kindly provided to me. I hope to write an analysis and commentary on this chart after its initial publication.

140 Olympiodorus (Boer, 59.8–15). See Appendix 10.C for the text.

141 Clues in the text point to Venus being in Virgo. If we suppose that Venus is at 1° Virgo, and assume that the chart is diurnal with a ♎ 4°30' Ascendant, the arc between the Lot of Daimon at 22° Gemini and 1° Virgo is 69°, which added to the ♎ 4°30' Ascendant is ♎ 13°30', very close to the text position of 12° Gemini for the Lot of Eros.

142 Abū Ma'shar, *De rev. nat.* (Pingree, 126.21–132.7) See Appendix 10.C for details.

143 Ibid., 126.24–26, 128.1–4, 129.1.

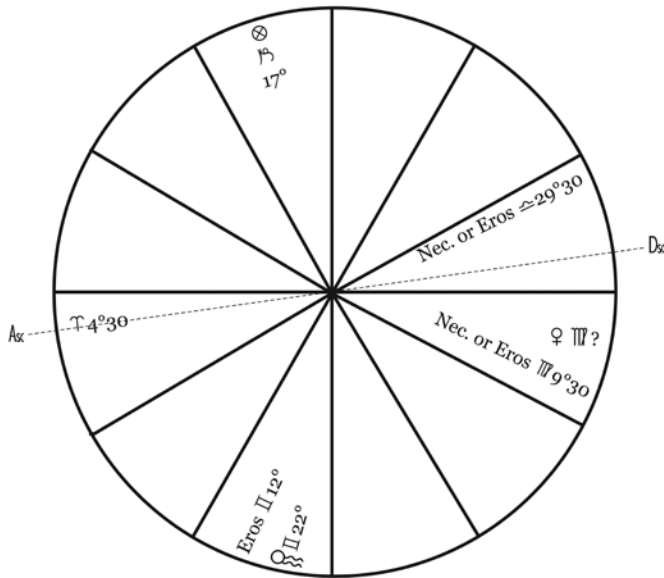

FIGURE 10.11 Hypothetical Olympiodorus chart.

Lot of Fortune will use the arc from Moon to Sun and thence from the Ascendant, and the Lot of Daimon will use the arc from Sun to Moon and thence from the Ascendant. The Lot of Fortune is δ 6°08' and the Lot of Daimon is ζ 29°40'. The Lot of Courage is given in the text as being 4°20' from the Ascendant, which comes to γ 7°14'.¹⁴⁴ Using the Hermetic formula for this lot at night gives γ 7°15'. The Lots of Victory, and 'Intellect and Native Wit' (as Abū Ma'shar names the Hermetic Mercury lot) are given in the text as being in Taurus in a higher longitude than the Lot of Courage.¹⁴⁵ Using the nocturnal Hermetic formula for Victory gives a position of γ 12°08'. Using the nocturnal Hermetic formula for Necessity gives a position of γ 18°53'.¹⁴⁶ Both of these lots fit perfectly with the text descriptions.

144 Ibid., 130.1–2. 'I found 4 degrees 20 minutes between the degree of the Hour-marker and the Lot of Bravery ... Εἶρον δὲ μεταξύ τῆς ὥροσκοπούσης μοίρας καὶ τοῦ κλήρου τῆς ἀνδρείας μοίρας ὄλεπτά ...

145 Ibid., 129.3–8, 130.1–131.19. Abū Ma'shar is dealing only with what falls in the Hour-marker, which is Taurus. The lots are mentioned in sequence through that place.

146 Could Abū Ma'shar be talking about some other lot than the Hermetic Mercury lot whose formula uses Fortune and Mercury? In the *Abbreviation*, Abū Ma'shar does list a 'lot of the intellect and profound thought' which is 'taken by day from Saturn to the Moon, by night the opposite, and <the degrees> are cast out from the ascendant.' (*Abbreviation* 1, 77 [no. 44]; *Abbreviation* 2, 48 [no. 44]). But calculating this lot using the planetary positions

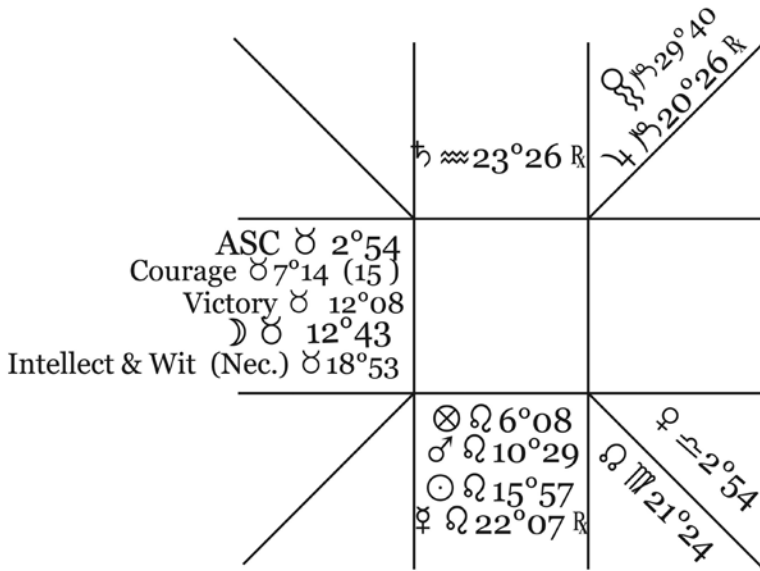

FIGURE 10.12 *Abū Ma'shar chart, from De revolutionibus nativitatum 3.1.*

Though this chart is outside the pure Hellenistic spectrum, it is of interest for two reasons. First, it clearly uses the Hermetic formulae for the planetary lots. Second, it does not call the Hermetic Mercury lot 'Necessity', but rather the 'Lot of Intellect and Native Wit' (*κλήρος τῆς φρονήσεως καὶ τῆς συνέσεως*), and it seems not to be a malefic lot in any way, contrary to the usual descriptions of this lot. This may be a clue to later thinking about what this lot represents in interpretation. It is to interpretation, both of the lots and the concepts behind them, that we now turn.

3 Interpreting the Lots in Context

In the astrological system used by Valens, Firmicus and others, Eros and Necessity are further extensions of Fortune and Daimon. They are counterparts equidistant from the point of incarnation (the Ascendant), and they are linked by this equidistance. They are not true opposites, as Eros and Eris are, but in

provided in this example gives $\approx 13^{\circ}37'$, which does not match the text description of this lot being in Taurus. Neither do calculations of either of the Egyptian formulae for Necessity give anything in Taurus. So it seems fairly clear that in this example chart in *De rev. nat.*, Abū Ma'shar is using the Hermetic Lot of Necessity formula.

astrological practice they become so—Eros, for instance, signifies friendship, and Necessity signifies enemies. Yet friends and enemies are both linked—one by attraction, one by repulsion. They are more like opposite sides of the same coin. (This is psychologically difficult to acknowledge—who wants to think they are in any way like their enemies?)

Eros and Necessity are really (spatially in the chart, if not metaphorically in other ways) mirror images of each other (as are Fortune and Daimon). Mirrors, of course, reflect, but what we see in the mirror is not the actuality of the image, but one reversed. Still, both actuality and image are linked, for without an actual body in front of the mirror, there is no image to be had. In an astrological chart, the mirror images of Eros and Necessity visually show this link. The question we may ask now is, why? What reasons could there be for linking Eros and Necessity?

3.1 *Binding Systems*

Could Eros be a counterpart to Necessity in astrology because they are both systems of binding? In the Myth of Er, the Hermetic writings and the Orphic theogony, Necessity is essential in the representation of the world that includes the heavenly system of stars and planets. The spindle of Necessity is the centre pole about which the cosmos is bound together. Eros, too, is fundamentally a binding, uniting, joining principle. Heinz Schreckenberg's philological analysis of *anankē* aims to connect *anankē* semantically with binding words such as *desmos*.¹⁴⁷ It may also derive from a fundamental meaning of ἀναγκάζω, 'take in one's arms'.¹⁴⁸ (And ἀναγκάζω in turn is related to words like ἀγκάλη, 'a bent arm'; ἀγκάς, 'in the arms'; and ἄγκος, 'a bend'.)¹⁴⁹ The etymology of Eros is unknown,¹⁵⁰ but certainly Eros has long been associated with unions brought about by love. Eros is also a creative, joining and binding force in the cosmologies of Hesiod, Parmenides, Empedocles, the *Hermetica*, Chaldean Oracles

147 H. Schreckenberg, *Ananke: Untersuchungen zur Geschichte des Wortgebrauchs* (Munich: Beck, 1964), e.g. 8, 175–176. Onians, *Origins of European Thought*, also has extensive studies of binding words and their applications, including to necessity and love; see esp. 332–33, 368–73, 403.

148 Chantraine, Tome I, 83. We are reminded of the Orphic Ananke-Adrasteia stretching out her arms and encompassing the entire cosmos, as well as the Platonic cosmos, with Ananke as its axis, encircled by a bond of light, 'the bond of heaven... which holds together the circle of the universe' (*Rep.* 616c),... εἶναι γὰρ τοῦτο τὸ φῶς σύνδεσμον τοῦ οὐρανοῦ... οὕτω πᾶσαν συνέχον τὴν περιφορᾶν... Onians, *Origins of European Thought*, 332, has also pointed out this connection between Ananke and bonding.

149 LSJ, s.v.

150 Chantraine, Tome II, 364, 'inconnue'; Frisk, Band 1, 547, 'ohne Etymologie'.

and Orphic texts. In astrology, blatantly via the lots, there are deliberate connections between Eros and Ananke, two binding principles whose expression comes about in different ways. One may be a more pleasurable binding than the other, but both are characterised by their ability to make bonds.

3.2 *Choice and Persuasion vs. Force and Compulsion*

In astrology the Lot of Eros signifies voluntary associations and desires by choice, while Ananke is, by its very meaning, compulsory: the earliest, most fundamental meanings of the Lot of Necessity were associations that were not by choice, i.e. enemies one *must* contend with, as opposed to friends. These significations for the lots, and even the fact that astrology joins Eros and Ananke in this way, oblige us to look at the cultural implications of Eros and Ananke in terms of choice and force.

In the caduceus of Macrobius, Necessity is a knot, something that binds, while Eros is a kiss, a voluntary joining. Yet this may not be as black and white as it seems. The knot of Hercules can be used not only to bind by force, but to secure, to make safe. It is even said to cure wounds.¹⁵¹ With Eros, too, there is a paradox, for Greek mythology is full of people shot by the arrows of Eros and compelled toward love. There is also the idea of wanting (Eros) versus needing (Ananke);¹⁵² what we desire is not necessarily what we need. Paradoxically, having our needs met will allow us to survive.

The associations between Eros and persuasion, and Ananke and force or compulsion are significant; these two are related, in that they both produce a certain result, but one allows the possibility of choice (or at least the illusion of it) and the other denies it. Both, however, may be necessary for society to function well.

In Herodotus (8.111.2), Themistocles arrives at the Island of Andros with two goddesses, Peitho and Ananke.¹⁵³ In *Republic* (519e), Plato tells us the rulers of the ideal state will govern the citizens by ‘both persuasion and necessity’¹⁵⁴

151 Pliny, *HN* XXVIII, 17.63: ‘Vulnera nodo Herculis praeligare mirum quantum ocior medicina est...’. ‘To tie up wounds with the Hercules knot makes the healing wonderfully more rapid...’ (trans. Jones). Latin quoted in R. Ferwerda, ‘Le serpent, le nœud d’Hercule et le caducée d’Hermès. Sur un passage orphique chez Athénagore’, *Numen* 20, no. no. 2 (1973): 104–15, here 111, n. 28.

152 Thanks to Saara Leskinen for pointing this out.

153 Herodotus, *Histories*, trans. Godley, VIII, 111.2 (Rosén, II, 363.116–117):...ὡς ἦκοιεν Ἀθηναῖοι περὶ ἑωυτοὺς ἔχοντες δύο θεοὺς μεγάλους, Πειθῶ τε καὶ Ἀναγκαίην... ‘...as the Athenians had brought with them two great gods, Persuasion and Necessity...’

154 ... συναρμόττων τοὺς πολίτας πειθοῖ τε καὶ ἀνάγκῃ....

(one wonders if this is where Freud got the idea for his discussion of Eros and Ananke).

In Greek iconography, Peitho (Persuasion) is often associated with Eros or Aphrodite (especially Aphrodite Pandemos).¹⁵⁵ In some representations, Peitho or her Roman counterpart Suada is said to have a caduceus at her feet, the caduceus in this instance probably being a symbol of peace.¹⁵⁶ But the caduceus could also be symbolising both persuasion and compulsion.

Persuasion and compulsion bring up the problem of reason (*logos*):¹⁵⁷ one can be persuaded by reason, whereas in compulsion one may be compelled against reason. Reason may, however, supersede Necessity.¹⁵⁸ In *SH VIII*,¹⁵⁹ Hermes talks of three kinds of 'incorporeals' which affect human lives, the

-
- 155 Among numerous examples, a kylix by the Meidias Painter shows Peitho and Eros persuading Demonassa (Getty Museum); Pausanias reports (*Description of Greece* 1, 22.3) a cult of Peitho and Aphrodite Pandemos on the Acropolis; for more see the section on Peitho in A. C. Smith, 'Athenian Political Art from the Fifth and Fourth Centuries BCE: Images of Political Personifications', *Dēmos: Classical Athenian Democracy*, ed. Christopher W. Blackwell, edition 18 January 2003 (A. Mahoney and R. Scaife, eds, *The Stoa: a consortium for electronic publication in the humanities* [<http://www.stoa.org>]): 1–26, here 20. http://www.stoa.org/projects/demos/article_personifications?page=20&greekEncoding=UnicodeC (accessed 1 January 2009).
- 156 M. O. Howey, *The Encircled Serpent: A Study of Serpent Symbolism in All Countries and Ages* (New York: A. Richmond Co., 1926, repr. 1955), 73. In *De astronomia* (II, 7), on the constellation Lyra, Hyginus relates the origin of the caduceus. In this version, Hermes uses his wand to separate two fighting snakes from each other, the caduceus thereby becoming a symbol of peace.
- 157 *Logos* has numerous meanings (five and a half columns in LSJ), including relation, proportion, reckoning, speech, word, utterance, even oracle. For the ideas in these two paragraphs, I am indebted to R. Hand, 'Fate and Astrology: Some Ancient Insights', *The Mountain Astrologer* Mercury Direct section (February/March 2006): 2–11, esp. 5–6.
- 158 That Necessity and *logos* were considered as separate is not unique to the Hermetists. Nor were they the first to think about necessity and *heimarmenē*. Leucippus states that 'all things are according to necessity, and this is actually *heimarmenē*. For he says in "On Mind" that nothing useful comes to be in vain, but all things are both from reason and by necessity.' D-K, II, 81.3–6, Leucippus B2: Λεύκιππος πάντα κατ' ἀνάγκην, τὴν δ' αὐτὴν ὑπάρχειν εἰμαρμένην. λέγει γὰρ ἐν τῷ Περὶ νοῦ· οὐδὲν χρῆμα μάτην γίνεται, ἀλλὰ πάντα ἐκ λόγου τε καὶ ὑπ' ἀνάγκης. (partially quoted in L. Edmunds, 'Necessity, Chance and Freedom in the Early Atomists', *Phoenix* 26, no. 4 (1972): 342–57, here 343). See also *Timaeus* 47e–48a; Cicero, *De natura deorum* I, 20.55.
- 159 *SH VIII* (Nock and Festugière, *CH III*, 47–48); Scott, *Hermetica*, I, 420–23. This excerpt connects, as Festugière has said (III, lxi), to Excerpt VII (which clearly references the Parmenides fragment from Aëtius discussed earlier); in Excerpt VII, Pronoia and Necessity are set over divine order, and Dike is set over men, who are placed under *Heimarmenē*

first according to Providence, the second according to Necessity and the third according to Fate (*Heimarmenē*).¹⁶⁰ The first is noetic and has *logos*; the second is non-rational (*alogos*), but can be swayed by the first; and the third incorporeal is the form and attributes of the body.¹⁶¹ The first incorporeal, if it 'draws near to God', is said not to be subject to Necessity but to be in accord with Providence.¹⁶²

In Plutarch's Myth of Timarchus (*De genio Socratis*, 591d-592c), the highest part of the soul, the noetic, the 'rational', follows the daimon; and we have already seen the daimon associated with the third level of *pronoia* (Providence).¹⁶³ So, at least in the Hermetic tradition, there is an ability to escape Necessity by attaining *logos*. This, then, is a way for a human being to escape some kinds of fate (those caused by *alogos*, which are a result of *agnoia* [ignorance], not *pronoia*).

3.3 *Fortune and Necessity; Spirit and Love; Daimons and Reality*

Necessity also joins with fortune or chance in Greek literature; for example Tecmessa, in Sophocles' *Ajax* (Lloyd-Jones and Wilson, line 485), speaks of *ἀναγκαία τύχη*, necessary chance. There are several ways to interpret this: 1) It is necessary that chance exist; 2) chance is necessary in or for the

through their actions. Excerpt VIII then continues the discussion of *Pronoia*, Necessity and *Heimarmenē*.

160 SH VIII.1, (Nock and Festugière, *CH* III, 47):... ἄλλ' ἔτι με ἀνάμνησον τίνα ἐστὶ τὰ κατὰ πρόνοιαν καὶ τίνα <τὰ> κατ' ἀνάγκην, ὁμοίως καὶ καθ' εἰμαρμένην; '[Tat to Hermes]:... but remind me again, what things are according to Providence, what according to Necessity, and likewise according to *Heimarmenē*?'

161 SH VIII.2-4, Ibid. III, 47:... τρία εἶδη ἀσώματων· καὶ τὸ μὲν τι ἐστὶ νοητόν... ἐξ αὐτῆς τῆς πρώτης καὶ νοητῆς οὐσίας. Εἰσὶ δὲ καὶ ἐν ἡμῖν τούτῳ ἐναντία σχηματότητες· τοῦτο ὑποδέχεται... πρὸς τίνα λόγον... τρίτον δὲ ἐστὶν εἶδος ἀσωμάτων ὃ περὶ τὰ σώματα ἐστὶ συμβεβηκός... '[2] [Hermes to Tat]:... there are three incorporeal forms; the first is something noetic... from its own first and noetic being (*ousia*). [3] There are also in us opposite forms to this; this [noetic one] receives [them]... according to some rationality (*logos*)... [4] The third incorporeal form concerns what befalls the bodies...'

162 SH VIII.5-7, Ibid. III, 48: ἡ μὲν οὖν νοητὴ οὐσία, πρὸς τῷ θεῷ γενομένη... ὑπὸ ἀνάγκην οὐκ ἔστιν... τὸ δὲ ἄλογον πᾶν κινεῖται πρὸς τίνα λόγον. καὶ ὁ μὲν λόγος κατὰ πρόνοιαν, τὸ δὲ ἄλογον κατ' ἀνάγκην, τὰ δὲ περὶ τὸ σῶμα συμβεβηκότα καθ' εἰμαρμένην. '[5] The noetic being (*ousia*), when it draws near to God... is not under Necessity... [6] The non-rational [part] is moved wholly according to the rational. [7] And the rational is according to Providence, the non-rational according to Necessity, and those things that befall bodies according to *Heimarmenē*.'

163 See Chapter 1, 2.1 31-33.

functioning of the world; 3) chance a.k.a. fortune compels certain action.¹⁶⁴ In tragedy, I suppose it is the event/knowledge (or the non-event/ignorance) that leads necessarily to the tragic end. (If only he had known. . . .)

What are we to make of this in regard to the lots in astrology? In the Paulus-Hermetic formula, Necessity is connected with Mercury and *Fortune*; it is of the material world, and therefore of the things that happen to the body. We think of chance as random, but this association with a Necessity that is fated would be anything but random. We go back, again, to the Myth of Er and the souls' compulsion to choose a life in the order the lots assign them. The lots are scattered; the souls pick them up, apparently randomly; but it is this chance randomness, this ordered disorder, that will ultimately ordain the life they choose.

In all of this the daimon is literally hanging over our heads (as in the Timarchian myth).¹⁶⁵ Both Necessity and Eros are called daimons; and it is the daimon who is chosen to guard and guide our lives. Here there appears to be a collusion between ourselves and our daimon, for *we* choose our daimon—it does not choose us. The individual daimon does not force us to pick it specifically; we are given the final choice, but once we have made it, the daimon becomes our guiding force. The daimon, as a mediator between gods and humans, comes from the noetic world, but it guides us both in the physical world and the noetic world.

This kind of 'both/and' duality (i.e., a 'daimonic' duality which is both physical and noetic) is clear in the Fortune/Daimon formulae for the Lots of Eros and Necessity: the Lot of Necessity may seem to emphasise more the constraints of the physical world, and the Lot of Eros the psychic joys, but both are formed from the Lots of Fortune and Daimon, and signify the experiences of both body and soul/spirit. They too are expressions of the daimonic *ethos*, the bridging of worlds.¹⁶⁶

164 Regarding Greek physics, the relationship between necessity and chance/fortune is problematic; it is discussed, e.g., in Aristotle's *Physics* 2.4. For more on physics, necessity and chance, see Edmunds, 'Necessity' and R. Sorabji, *Necessity, Cause and Blame: Perspectives on Aristotle's Theory* (London: Duckworth, 1980).

165 Plutarch, *De genio Socratis*, 591e. See below, n. 166.

166 *Timaeus* 81d–e talks about the soul at death released from its bonds, and flying out with pleasure from the body; this is similar to the Myth of Timarchus in *De genio Socratis* 590b–c, where the soul is released from Timarchus's body after he has been struck on the head. Here the strike on the head causing the release may be because the highest part of the soul is at the top of the head, where the daimon is said to reside in *Timaeus* 90a; in the Myth of Timarchus, the daimon floats above the soul, connected by a thread—again, something which binds it—and pulls the part of the soul which is amenable to it upright.

Eros is both body and soul, as Plutarch knows. It is an expression in the material world of an impulse that we cannot see physically, but only imagine. (Thus it is, in another way, daimonic. It comes from a world outside of the one we think we are living in.) Eros is not either/or but both/and.

Eros is also both earthly and heavenly (the *Symposium's* Eros Ouraniou and Eros Pandemou). It is hard for the Greeks, perhaps, to reconcile the 'sexual desire' part of Eros, with the 'creative force' and 'heavenly reason' part of Eros. In other cultures (such as the Egyptian) from which Greek astrology took a number of doctrines, this dichotomy did not really play a part. But the Lot of Eros, in interpretation and in divergent formulae, seems to have some of this same dichotomy. Eros in its Fortune/Daimon formula may have more to do with the general possibilities of alliances and associations in a human's life, but the lot's association with Aphrodite brings it into the mundane and material world of friends and sexual love. Hellenistic astrology often seems to tread this fine line between the ideal and the real. Or perhaps astrology seeks to reconcile these two positions, to show humans the possibilities in a general and universal sense, as well as those in a singular and particular sense as applied to one's own particular chart.

Lastly, what is the meaning behind the creation of the Lots of Eros and Necessity from the Lots of Fortune and Daimon? Put another way, Love and Necessity in astrology arise out of Chance/Fortune and Daimon/Spirit. Here, literally showing in the birthchart, is a manifest statement about human culture and religion which links these fundamental principles and applies them to an individual within that culture. Certainly most people who went to astrologers in the Hellenistic astrological timeframe would not be asking for such lofty philosophical expositions; they were interested in the usual questions about love, work and quality of life that are constants in human living. But by combining the earthly and the heavenly, astrology allows for expressions of both the material and the spiritual (divine and daimonic) world, and implicitly and explicitly incorporates them into its technique.

Epilogue: Caduceus Redux

Few studies on the caduceus even consider astrological connections with it. (In fact, there are not very many studies of the caduceus at all, and those that do

(See Onians, *Origins of European Thought*, 334–37 for connections between binding and threads.)

exist tend to focus on medicine or on the serpents and their roles.)¹⁶⁷ Only two contain anything relevant to our examination. Rein Ferwerda deals specifically with the Athenagoras quotation we cited earlier. He observes that serpents are able to predict and are associated with diviners and have healing powers.¹⁶⁸ He speaks of the knot of Hercules as both binding and healing.¹⁶⁹ Ferwerda makes no mention of astrological significance for the caduceus, though he does see a cosmogonic and metaphorical spirit/body significance.¹⁷⁰

The second study, by Jean Boulnois, is mostly concerned with the Dravidian origins of the caduceus, but two sections of his book are of interest. First, he describes a statue from the Mithraeum at Ostia which contains many of the Orphic features we saw in the statue of Phanes-Protagonos, as well as a caduceus. Cumont provides a drawing:

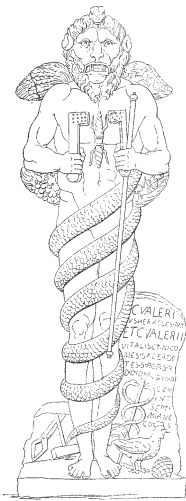

FIGURE 10.13
*Mithraic Kronos representing Aion or Boundless Time, Mithraeum at Ostia, 190 CE.*¹⁷¹

167 We have already mentioned Howey, *The Encircled Serpent*; and Ferwerda, ‘Le noeud’ (Ferwerda’s study is useful both for the sources he cites and for showing how to tie a knot of Hercules, 110); in addition J. Boulnois, *Le caducée et la symbolique dravidienne indo-méditerranéenne, de l’arbre, de la pierre, du serpent et de la déesse-mère* (Paris: Librairie d’Amérique et d’Orient, 1939); and A. L. Frothingham, ‘Babylonian Origin of Hermes the Snake-God, and of the Caduceus I’, *AJA* 20, no. 2 (1916): 175–211.

168 Ferwerda, ‘Le noeud’, 107–08.

169 *Ibid.*, 111 and n. 28.

170 *Ibid.*, 113–14.

171 F. Cumont, *The Mysteries of Mithra*, trans. Thomas J. McCormack (Chicago: Open Court Publishing Company, 1903), 105 (online version: http://www.sacred-texts.com/cla/mom/mom07.htm#page_105, accessed 1 January 2009). Cumont’s caption reads: ‘The

Boulnois also briefly discusses our Macrobius passage. In it he mentions the work of Antoine Court de Gébelin¹⁷² who, following Macrobius, supposed that the serpents were the Sun and the Moon, 'qui, dans le cours d'une année parcourent l'Écliptique sur lequel ils sont tantôt séparés, tantôt unis.'¹⁷³ Court de Gébelin suggests that the wand symbolises the equator and the wings Time; the knot of Hercules is the moment where Sun and Moon meet on the equator—he describes the Head and Tail of the Dragon (the Moon's Nodes) as the place on the ecliptic where Sun, Moon and planets meet.¹⁷⁴ For Court de Gébelin, the caduceus is an astronomical symbol *par excellence*. But none of these caduceus studies mention an astrological significance, and only Court de Gébelin comments on the Sun and Moon connection.

Let us consider the astrological symbolism in the caduceus. The snakes in the caduceus are joined in two places: at the knot of Necessity and the kiss of Eros, a literal representation of the joining properties both of Eros and Ananke. The snakes also represent Fortune and Daimon, and the two places of joining may even give a visual rendering of the Lots of Fortune and Daimon combining to produce Eros and Necessity. In addition, Macrobius says the snakes are male and female, Sun and Moon—and the fact that they meet both by their tails and their mouths metaphorically suggests procreation. As metaphors for the Sun and Moon, they bring the heavens into the picture;¹⁷⁵ and since we know that

statue here reproduced was found in the mithræum of Ostia before mentioned, where C. Valerius Heracles and his sons dedicated it in the year 190 AD. This leontocephalous figure is entirely nude, the body being entwined six times by a serpent, the head of which rests on the skull of the god. Four wings decorated with the symbols of the seasons issue from the back. Each hand holds a key, and the right in addition a long scepter, the symbol of authority. A thunderbolt is engraved on the breast. On the base of the statue may be seen the hammer and tongs of Vulcan, the cock and the pine-cone consecrated to Æsculapius (or possibly to the Sun and to Attis), and the wand of Mercury—all characteristic adjuncts of the Mithraic Saturn, and symbolizing the embodiment in him of the powers of all the gods.' This drawing also in F. Cumont, *Textes et monuments figurés relatifs aux mystères de Mithra*, 2 vols. (Brussels: H. Lamertin, 1896–1899), vol. II, 238.

172 Eighteenth century philosopher and symbolist who wrote nine volumes, *Monde Primitif*, on languages, symbolism and allegory in the ancient world.

173 A. Court de Gébelin, 'Allégories Orientales', in *Monde Primitif*, vol. 1 (Paris: Chez l'auteur, Boudet, Valleyre l'aîné et al., 1777), 113 (also cited in Boulnois, *Le caducée*, 168). Court de Gébelin had already (109–10) discussed Mercury as the inventor of astronomy; in his opinion of the caduceus, Mercury's symbol, he carries that idea further.

174 Court de Gébelin, 'Allégories Orientales', 113–14.

175 Aside from Court de Gébelin's image, the snakes twining around the shaft of the caduceus correlate with the Sun, Moon and planets whirling around the spindle from the myth of Er, or with the Orphic Chronos/Ananke as the axis of the cosmos.

the Sun and Moon create the Lots of Fortune and Daimon, and those lots then create the Lots of Eros and Necessity, I think we can safely conclude that this rendition of the caduceus has astrological implications.

Giuseppe Bezza also recognised the caduceus of Macrobius as astrologically significant.¹⁷⁶ He terms the lots of the caduceus as those of 'the Sun, the Moon, Venus and Mercury',¹⁷⁷ following the tradition of Paulus Alexandrinus; yet I believe that the Lots of Eros and Necessity have been singled out in the caduceus not because they are associated with Venus and Mercury,¹⁷⁸ but because their very existence is bound up with the lots that precede them, those of Fortune and Daimon. It is because they are *formed* from Fortune and Daimon that they become so important. These 'Egyptian' formulae may have preceded those of Paulus (the newly-discovered birthchart of 319 is within the timeframe of Paulus's *Introduction* of 378 CE), or the Hermetic formulae lost until Paulus. Furthermore, after the introduction of the Paulus-Hermetic formulae, there seems to have been a conflation of the two traditions. The lots of Eros and Necessity are called the 'planetary' lots of Venus and Mercury, but the Arabic tradition seldom promotes or uses the planetary formula for them, even though it calls them 'planetary lots'.¹⁷⁹

In any event, the singling out of these four lots in the caduceus, and by astrologers like Vettius Valens, shows the magnitude of the ideas identified with them. For the Greeks, as well as any 'Hellenized' person living in these

176 Bezza, *AM*, II, 972–73. Bouché-Leclercq, *AG*, 293 n. 1, as well, mentions the Macrobius passage in his section on lots.

177 Bezza, *AM*, II, 972.

178 As if those gods/planets were somehow more important than Saturn, Jupiter or Mars.

179 The standard formulae given in Abū Ma'shar, al-Bīrūnī, Ibn Ezra and Bonatti do not use the planets for the lots of Love and Necessity (the Latin name for Necessity is different, but the formula the same). In Abū Ma'shar's chart the Hermetic Lot of Necessity, using Mercury in its formula, metamorphosed into the Lot of Intellect and Native Wit, clearly a name more apt for Mercury. In Abū Ma'shar, the Lot of Necessity (using the Valens version of the Fortune/Daimon formula) is called either the Lot of Poverty and Lack of Means (*Abbreviation* 1, 71, *Abbreviation* 2, 42) or the Lot of (Slight) Intellect (*ingenium* or *modicum ingenium*) (*Greater Introduction*, 332, Tractate VIII, 3,444–49); here is the conflation in action, since the meaning of the lot is 'poverty, war and fear, also hatred and a multitude of dispute, and enemies, anger, disputes in time of anger, negotiations, buying and selling, also reasoning powers and talents, and writings and number and seeking different sciences and astronomy.' 'Et hec significat paupertatem et bellum ac timorem, odium quoque et multitudinem contentionis, et inimicos et iram et contentiones in hora ire, et negotiationes, emptionem et venditionem, cogitationes quoque et ingenia, et scripturas ac numerum et petitionem diversarum scientiarum et astronomie.' This passage appears almost verbatim in Bonatti (see n. 114).

times, Tyche, Daimon, Eros and Ananke would be seen as manifestations of cosmological principles, but more importantly, as some kind of divinity (whether godly or daimonic). As such, they would be intimately bound up in the fate and choice of a human, and therefore they become divinatory tools.¹⁸⁰ Through these lots, the astrologer may discover not only how the affairs signified by each lot relate particularly to the native, and the propitiousness of their placement in the chart,¹⁸¹ but also find, through using the lots in timing systems such as zodiacal *aphesis* and profections, what is in store for the native in the future.

However, the lots may also be viewed through the other end of the telescope, so to speak. The way these lots are used in astrology has something to say about how these concepts are viewed in the wider culture. While Eros and Necessity are connected in Hermetic and Orphic literature, and in Macrobius's description of the caduceus, it is in astrology that Eros and Necessity (not to mention Fortune and Daimon) are seen as linked mirror-images of each other. It is in astrology that we have direct apprehension of both the material and physical implications of Eros and Necessity (friends and enemies, favours and imprisonments) as well as the psychological implications (sympathy, affection and enmity, desire and compulsion). It is in astrology that the cosmological functions of Eros and Necessity are brought to a personal level, in a way that brings home the connectedness of the cosmos to the individual and reinforces the link between the heavenly and the earthly, the spiritual and the material, the macrocosm and the microcosm.

180 This may be a clue to why these lots are singled out, as important in predictive techniques, from the others commonly used (e.g. Lots of Father, Mother, Siblings, Marriage, etc., as well as the other 'planetary' lots). Hephaestio tells of their importance in katararchic astrology, which perhaps more than any other branch of astrology reveals its divinatory foundation. Cf. the quotation of Dorotheus in Hephaestio, III, 6.11 (see above for the discussion of this passage, 2.1, 360, 366–67). Cf. also, for the divinatory foundations of astrology, Cornelius, *Moment of Astrology*.

181 See Valens, IV, 11.49 (Pingree, 167.20–22) (cited on 357 and n. 91, above). Note that the word translated as 'operative' is *χηρηματιστικός*, which can also mean propitious, and which has strong connections with oracles.

Conclusion

Run on, spindles, run on, drawing out the spun threads.
currite ducentes subtegmina, currite fusi.

CATULLUS, *Poem 64*, 327¹

1 Weaving the Tapestry

Each chapter of this book forms a separate but interconnected world of its own, in which I have explored the daimon and its relationship to Hellenistic astrology from a particular perspective. Each perspective has illustrated and illuminated various facets of the daimon and astrology. These microcosmic portraits will now be placed within their macrocosmic framework, as parts of a larger tapestry. They are revealed not as isolated worlds but as portions of a whole, woven and connected by many threads.

These interweaving threads are the themes which carry across many of the book's chapters. Seven continuing themes appear:

- 1) the indissoluble link between daimon and fortune;
- 2) the daimon's relationship with fate;
- 3) astrology as a paradigm of determinism and/or fatalism;
- 4) personal destiny and the personal daimon;
- 5) the influence of astrology and the daimon;
- 6) the influence of the Myth of Er;
- 7) Porphyry as a link between Plato, the daimon, astrology and fate.

The themes reappear in different guises, seen from different angles. In addition to the observations already made at the ends of each of the previous chapters, looking at how these themes weave in with the overall study will provide further enlightenment as outlined below.

1 Catullus, *Carmina* (Mynors). Phrase repeated at lines 333, 337, 342, 347, 352, 356, 361, 365, 371, 375, 378, 381.

2 Following the Threads

2.1 *The Indissoluble Link between Daimon and Fortune*

Links between daimon and fortune in astrology (via the places and the mirror-image Lots of Daimon and Fortune) echo their bonds in culture. This is seen repeatedly throughout the book. Plutarch discusses both the fortune and the daimon of his subjects in the *Parallel Lives*; though some have considered his use of *tuchē* and *daimōn* interchangeable, it is rather an interdependence which is highlighted. The same interdependence occurs in astrology, through the paired fifth/eleventh, sixth/twelfth places, and through the Lots of Fortune and Daimon formed by reversing the calculation of the arc between Sun and Moon. The importance of the sun and moon in Plutarch's daimonology is paralleled by the importance of the Sun and Moon in astrology; astrology, furthermore, connects the Sun and Moon to Fortune and Daimon. Astrology literally shows the place of the Good Daimon in the solar hemisphere and the place of Good Fortune in the lunar one.

In Egypt, the cults of Shai and Renenet, Sarapis and Isis, merge in Ptolemaic and Roman times with those of Agathos Daimon and Agathe Tyche. Their cults in Roman Egypt are well-attested. Tyche and daimon were so familiar a pair that Isaiah 65:11 used the Hebrew Gad and Meni to represent them. Their pairing is so entwined that the two can even be conflated and confused (as they are in the Septuagint). In astrology, Manilius associates the Good Daimon place with (Felix) Fortuna, and the Good Fortune place with Daimonie, another example of this convergence and interdependence. Both daimon and fortune (chance) are implicit in the idea of a lot: in the Myth of Er, both daimon and chance (*tuchē*) are critical components of the soul's choice of a life. In astrology, the Lots of Fortune and Daimon are the two crucial lots from which the other planetary lots are constructed. The eleventh place from the Lot of Fortune is a place of acquisition, the implicit acknowledgement of the 'daimon' place as a means of acquiring fortune. Vettius Valens is careful in his astrological interpretations to show Fortune and Daimon working together in the creation of and reaction to events, both physically and mentally.

There is no Tyche without Daimon; there is no daimon without fortune. The fifth place must have the eleventh as its opposite, and so must the sixth and the twelfth be a pair. *Tuchē* and *daimōn* stand for body and soul and their mutual need for each other. In the same way Moon needs Sun and Sun needs Moon. In astrology we see what is implied in culture (fortune=body=moon, daimon=soul=sun) made explicit: the Lot of Fortune is the lot of the body and the Moon; the Lot of Daimon is the lot of soul and Sun. From there we can make any number of philosophical leaps: to the Sun and the mind, to *nous*, to

daimon inhabiting *nous*, the highest part of the soul, to the Moon and body and growth and decay, to the length of human life and its productivity.

2.2 *The Daimon and Fate*

Plutarch's Myth of Timarchus lays out the connection of souls with daimon and fate. The daimon in the Myth of Er is the guardian of *moira*. Iamblichus equates the personal daimon with an individual *moira*, and Proclus tells us that the daimon 'fulfils the decrees of fate and bestows gifts from providence.' This could not be a more apt statement of how Vettius Valens views his personal daimon and its providential gifts. The Pseudo-Plutarch essay *De fato* explains that the tertiary providence allotted to the daimons gives humans some choice, an 'antecedent' not controlled by fate; only the consequences of that choice are in accordance with *heimarmenē*. If one chooses to succumb to too much passion, an unfortunate fate is the result.

Greek ideas about fate and providence are placed in counterpoint to Egyptian and Mesopotamian ideas in this book. Shai underlies the Agathos Daimon in Ptolemaic and Roman Egypt, and contains the idea of fate as decreed by the gods, but which can be changed by propitiation or good deeds; the same concept appears in the Mesopotamian *šimtu*. This fate is negotiable. Porphyry thinks that knowing one's personal daimon can, by ritual, free one from his fate. The Agathos Daimon takes on Shai's attributes as a deity of fate, but a fate that is not fixed, which can be changed by petition to the gods.

2.3 *Astrology as a Paradigm of Determinism and/or Fatalism*

Not necessarily by design, the book has raised the issue of astrology's determinism leading to fatalism. The evidence brings a different scenario to light. The tertiary providence of *De fato* provides some space for escaping *heimarmenē* through a providence administered by daimons. Gnosis and *pronoia* can allow this escape. Valens may provide an example of this in second-century astrology. Even Ptolemy allows escape clauses, though his are physical and causal, whereas Valens' are metaphysical and revelatory. For Porphyry, finding his personal daimon in astrological practice enhances his own attainment of wisdom and virtue, and thereby allows an escape from *heimarmenē*.

Astrology's view of fate does not depend entirely on Greek conceptions, but is influenced by Egyptian and Mesopotamian ideas. These underlie astrological fate, in spite of protestations to the contrary by anti-astrology apologists (who followed Greek ideas of an inexorable fate). In this view, fortune is not blind or random, but a goddess who controls destiny. Fate is not utterly predetermined; its judgements can be appealed.

The possibility of choice is illustrated by the metaphor of a shipwreck in Plotinus and Vettius Valens; even though we are allotted certain circumstances in life, we have choice as to how to react to those circumstances. Astrology allots a certain configuration of stars and planets, but we can choose how to react within those parameters. Valens might say that it is the benefic planets in play in our chart which allow for the escape from threatening circumstances, but he might also rely on providence, via daimonic intervention, to provide the wished-for outcome.

Katarchic astrology is another example of negotiating fate. In katarchic technique, the succedent places (which include Good Daimon and Good Fortune), represent the future—an indication that change can be negotiated here. By contrast, the cadent places, including the Bad Fortune and Bad Daimon places, represent the past which cannot be changed; and also, perhaps metaphorically, the fixed fate given by yielding to the vice of passions or the bad daimon. Iamblichus allows katarchic astrology to set the time of theurgic rituals for best effect, as Zosimus does with alchemy; Manilius refers to katarchic astrology in his delineation of the places from the Lot of Fortune. The four lots of Fortune, Daimon, Eros and Necessity are explicitly used by Hephaestio in the *katarchē* for a ritual.

Astrological lots using Fortune and Daimon demonstrate both the material world, and mental intention and choice. Fortune represents the physical world of generation and corruption, but Daimon, in its association with *nous* and *phronēsis*, links with the conscious and intentional. As mirror images of each other, these lots are explications of a relationship between happenstance and intentionality: a *de facto* illustration of a non-fatalistic astrology (see definitions of fatalism in Chapter 9, Section 8).

2.4 *Personal Destiny and the Personal Daimon*

The idea of a personal daimon appears in various contexts. For Valens, his personal daimon helps him fulfil his destiny through providence. The Egyptian Shai is the personal guardian of destiny, while the personal daimon of a city is essential to its well-being. Some attributes of the Mesopotamian *lamassu*, e.g. that it guides and keeps its human safe and that it endows individual characteristics, are similar to those of a Hellenistic personal daimon.

The lineage of the personal daimon who guides a soul through its incarnated life passes from Plato to the Middle Platonists to Plotinus, Porphyry and Iamblichus, as well as other Neo-Platonists. Plotinus describes his version of a personal daimon who guides the soul from a higher level. Iamblichus finds it from the whole arrangement of the cosmos and from theurgical practice.

Porphyry uses astrology as a tool for finding an analogue of the personal daimon, who may then assist him in his own theurgical ascent to the divine.

The association of lots with the personal daimon in the Myth of Er may colour the meaning of astrological lots as an expression of the daimonic, as well as their use as particular and personal indicators in a chart (as in Valens II, 18.6). In Manilius (3.75–81), the lot places are even more particular to an individual than the places reckoned from the Ascendant. Valens' use of lots in predictive technique (e.g. *aphesis* from Fortune and Daimon, profections of lots, length of life) provides more ways of finding the correct personal outcomes for his clients. Where the Lots of Fortune and Daimon fall in the chart provide particular planetary rulers for times of life.

2.5 *The Influence of Astrology and the Daimon*

As a prominent component of cultures in the Mediterranean *oikumenē*, astrology has a presence in and influence on several facets of those cultures. In Mesopotamia and Egypt, it becomes an important part of religious practice, with priestly administrators. We find it expressed negatively in a religious context in Gnosticism, but positively in Mithraism.

The daimon plays an important role in Hellenistic philosophies, especially Platonic, as well as in religion. Combined with astrology, it is also viewed negatively in Gnosticism. As daimon and astrology become ever more vilified by early Christians, we find them combined into a matrix of evil practices, a convenient adversary to rail against. Astrology and the daimon are also combined in the Hermetica and magical papyri, in both positive and negative capacities. In Neo-Platonism, astrology and the daimon play a nuanced role, interpreted differently by different Neo-Platonists.

In the wider culture in general, astrological cosmology is accepted in how the cosmos is constructed. The ascent and descent of the soul through the planetary spheres, and each sphere's characteristics, is a common concept detected in several contexts within late antique culture.

The different elements of what constitutes divinity in a culture, and its relationship to astrology and the daimonic, have also been addressed in this study. Examinations of astrological practices have pointed up the fluidity of role between god and daimon, and even the distinctions between them. This can be seen in the way, for example, that decans are used in astrology. The development of the astrological doctrine of the *thema mundi*, the world's birthday, yields not only the birth of the world but the birth of a deity. By focusing on astrological practice, our understanding of the meaning and influence of the divine on humans is expanded and clarified.

2.6 *The Influence of the Myth of Er*

The Myth of Er comes up again and again in the book as a paradigm for the personal, guiding daimon leading a soul through life. The Myth of Er provides a philosophical justification for the lots as used in astrology: daimon and fortune are integral to the system of lots, and the Ascendant as the projection point represents the zodiacal moment of birth. Ananke's presence is large in the Myth of Er as well: she is the mother of the Moirai, the compulsion of the souls to choose a life based on where their lot falls, the turner of the spindle of time and space, and thus connected to the world of generation. Plotinus accepts Plato's version of the spindle, planets and Moirai (*Ennead* 11, 3.9), and that souls choose their lives but are affected by planetary configurations at birth. In Porphyry's interpretation, the moment of birth described in the Myth becomes linked with natal astrology and the choosing of a daimon to guide a life. In his essay *On What is Up to Us*, the daimon accompanies the soul into life, and the soul picks the life and incarnates at the proper astrological moment.

2.7 *Porphyry as a Link between Plato, the Daimon, Astrology and Fate*

It is rather astonishing how well Porphyry's specialised knowledge dovetails with an examination of the daimon in astrology. His treatise *On Abstinence* gives summaries of all the different kinds of daimons. *On the Cave of the Nymphs* deals not only with astrological cosmology but also mentions the propitiation of a natal daimon. His *Letter to Anebo* brings up the issue of finding an analogue of the personal daimon in the birthchart. His *Introduction to the Tetrabiblos* gives instructions for finding a house-master and lord of the geniture in the chart, which may be considered to represent the personal daimon. His *On What is Up to Us* applies astrological criteria to the entrance of souls into life, accompanied by their personal daimon; he interprets the Myth of Er in light of natal astrology. One might even suggest that he is trying to do for natal astrology in theurgy what Iamblichus does for katarchic astrology in theurgy.

Porphyry is the literal link between Plotinus and Iamblichus. He is also a link between Neo-Platonism and astrology, and surely was an influence on Proclus. His knowledge of Plato allows him to integrate the daimon, astrology and fate. And certainly his zeal for finding a personal daimon in the birthchart links the personal daimon to astrological practice.

3 Tying Off the Threads

In summation, this book has demonstrated the significance of the daimon within Hellenistic astrological theory and practice. It has shown the influence of religious and philosophical notions of the daimon on astrology, as well as astrology's manifest incorporations of these views. It has shown the possible use of astrology in theurgical practice and the practice of astrology reflecting current ideas about fate and providence. It has established traditions in astrology hitherto unrecognised by scholarship. It has shown the influence of the daimon within astrology on other aspects and facets of culture in the ancient Mediterranean world. It has revealed, in the case of the concepts of Fortune, Daimon, Love and Necessity, that astrology, more than religion or philosophy, has been able to connect these concepts in a concrete way.

The tapestry can always be expanded. Even the most compact area of study turns up additional and enticing subjects to explore. Keeping within the limitations of the time-frame I set for this study (ca. second century BCE—seventh century CE) meant that forays into the daimon's reception within Arabic astrology were few. This would be rewarding future research. Another area crying out for more attention is evidence of Egyptian components within Hellenistic astrology, especially as sources of later techniques. Such topics have begun to be covered by Egyptologists, but work by experts in astrology would enhance the richness of this research: it is an area ripe for scholarly collaboration. As an example, the relationship of the decans to the Hellenistic ὠροσκόπος has recently been explored.² Another area of particular interest for me is the Egyptian influence on Manilius. A thorough study of Porphyry's *Introduction to the Tetrabiblos* is another worthwhile project; as is a study of the astrology in his essay *On What is Up to Us*.³

The topics explored in this book will, I hope, change the automatic perception of astrology as a fate-bound and fatalistic practice, as tied to the tenets of a fixed and unalterable destiny as any of its adherents were supposed to have been. Astrology in antiquity is far more nuanced in its understanding of what is non-negotiable and what is up to us, just as many philosophies of this time are (Stoicism comes particularly to mind). Because of Hellenistic astrology's increasing marginalism in the face of those who would deny it on religious,

2 In 2009, after my dissertation was completed, I collaborated with Micah Ross on this topic, first at the conference 'Social and Religious Development of Egypt in the First Millennium BCE', Prague, 1–4 September 2009 and then in an article resulting from that conference.

3 This last will be the topic of my forthcoming article in *Neoplatonic Demons and Angels*, eds Luc Brisson and Andrei Timotin, to be published by Brill.

philosophical or 'scientific' grounds, its philosophical and doctrinal views, with some important exceptions, have been unknown, ignored or misrepresented in scholarship. This book has aimed to change this perspective. As for the daimon in astrology, this study has made the first inroads into understanding the relationship between these important topics and their influence in the ancient world.

Clotho has woven the tapestry, and Lachesis has allotted the measure of the fabric. Let Atropos cut the threads.

Appendices



Appendix I.A: Basic Techniques of Hellenistic Astrology

1 The Backbone of Astrology

The *technē* of astrology consists of three major elements: zodiac signs, planets—and what are called ‘places’ (τόποι) in Hellenistic astrology.¹ These are supplemented by three other important doctrines: ‘sect’, based on the division of day and night; ‘dignities’, the various rulerships of planets in signs; and ‘aspects’, the geometrical relationships planets make with one another.

1.1 Planets

Hellenistic astrology uses the five visible planets (Mercury, Venus, Mars, Jupiter, Saturn), the Sun and the Moon. The latter are called the ‘luminaries’. Often the term ‘planets’ refers to all seven visible bodies.

1.2 Zodiac Signs

The twelve zodiac signs, from Aries to Pisces,² are the backdrop on which the planets are placed and through which they move more or less in order.³ In the astrological chart which shows both planets and signs arranged in relation both to zodiacal order and to diurnal motion,⁴ the planets (including the Sun and the Moon) are each

1 But ‘houses’ in modern astrology.

2 The beginning of the (tropical) zodiac at Aries had been long established among the Greeks. The tropical zodiac is tied to the seasons; i.e., every year on the vernal equinox the sun is at 0° Aries. In the 2nd century BCE, Hipparchus placed the vernal point at the beginning of Aries. Antiochus of Athens (2nd century CE) explains the beginning of the zodiac with Aries because 1) Aries rules the head, the dominant human part, 2) Aries begins the spring and 3) spring (Aries) is associated with the first of the ages of man. See Antiochus, *Thesaurus*, Prooemium, in *CCAG* I, 142.4–143.10. For Ptolemy the zodiac starts with Aries because the wet excess of spring is its initial cause (*Tetrabiblos* I, 10, Hübner, 41–43).

3 Though this order was not always linear and in one direction, as the planets from Mercury to Saturn could be seen to stop, move backwards, and then move forward again; the Moon could also be seen to move north and south in declination (latitude from the celestial equator). The planets also appear to move west to east as they move through the zodiac (called ‘zodiacal’ or ‘secondary’ motion). These planetary motions were contrasted with the Sun, which regularly rose in the east and set in the west every day, a motion termed ‘diurnal’ or ‘primary’.

4 See n. 3.

placed, depending on where in the zodiac they fall, in one of twelve compartments called places.⁵

1.3 *The Places*

Each place consists of one zodiac sign⁶ and each is concerned with a particular area of life. The starting point for the chart is at the degree (μοίρα)⁷ rising on the eastern horizon at the time of birth (called the *Hōroskopos*, ‘Hour-marker’, later called Ascendant), and the entire 30-degree segment of both circle and zodiac sign in which this degree falls becomes the first place, called ‘Life’ (ζωή).⁸ The second place is ‘Livelihood’ (βίος), the third ‘Moon Goddess’ (θεὰ Σελήνης), fourth ‘The Underground’⁹ (ὕπóγειον), fifth ‘Good Fortune’ (ἀγαθὴ τύχη), sixth ‘Bad Fortune’ (κακὴ τύχη), seventh ‘Setting Place’

5 Several authors mention an eight-compartment system (the ‘Octatropos’ or ‘eight-turning’) including Julius Firmicus Maternus (*Mathesis*, II, 14), Antiochus (*Introduction*, 25, *CCAG* VIII/3, 117), and the anonymous author of P. Mich.inv. 1, 149 (col. ix.20–27). See Goold’s introduction, following Housman, in Manilius, *Astronomica*, lxi–lxii). Valens mentions an ‘*oktatropos*’ once, without elaboration, in IX, 3.5 (Pingree, 321.9).

6 By far the most prevalent among Hellenistic astrologers is this ‘one place/one sign’ system (called ‘Whole Sign’ by modern traditional astrologers). This is not to say that astrologers were unaware of the earth’s inclination which put the ecliptic at about a 23.5° tilt and, consequently, often made for a less than 90° angle between the rising and culminating degrees in an astrological chart (depending on the rising time of the sign on the eastern horizon); what is now known as the Porphyry place-system is described in Valens, III, 2 (Pingree, 127.17–128.26). But the whole sign/place system showed *areas of life*, while the rising or culminating angles (and those that set and anti-culminated) described the relative *strength* or *power* of signs or planets within that system. Yet all of Valens’ chart delineations use a one place/one sign system (thanks to Robert Hand for bringing this to my attention). Paulus Alexandrinus (378 CE) showed he was aware of this in his *Introduction*, ch. 30, ‘On the Midheaven’: ‘But it is necessary to know that the Midheaven degree does not always fall in the tenth from the Hour-marker, on account of the inequality of the zodiac sign’s temporal ascension, but sometimes on the ninth, sometimes on the eleventh.’ (Boer, 82.7–10): εἰδέναι δὲ χρὴ, ὅτι ἢ μεσουρανοῦσα μοῖρα οὐ πάντοτε ἐν τῷ δεκάτῳ πίπτει ἀπὸ τοῦ ὠροσκόπου διὰ τὸ ἀνίσον τῆς τῶν ζῳδίων χρονικῆς ἀναφορᾶς, ἀλλ’ ὅτε μὲν ἐπὶ τοῦ ἐνάτου, ὅτε δὲ ἐπὶ τοῦ ἐνδεκάτου. Olympiodorus, Paulus’s 6th-century commentator, appears to be the first of the Hellenistic astrologers to suggest that the quadrant system (in this case, the one later ascribed to Porphyry) be used for the places as signifiers of areas of life: cf. *Commentary on Paulus*, Boer 75–76; also Greenbaum, *Late Classical Astrology*, 118–20. For more on this topic, see R. Hand, *Whole Sign Houses: The Oldest House System* (Reston, VA: ARHAT, 2000), esp. 9–17; idem, ‘Signs as Houses (Places) in Ancient Astrology’, *Culture and Cosmos* 11.1 and 2 (2007): 135–62.

7 The same word as that used for the goddess of fate (see below, 3.3., ‘Moirā’).

8 See, e.g., Valens II, 16.1 (Pingree, 67.7); IV, 12.1, (Pingree, 170.2); Paulus, ch. 24 (Boer, 54.1). Perhaps more descriptive would be ‘Incarnation’ or ‘Physical Existence’.

9 Here I borrow Roger Beck’s translation for this place: R. Beck, *A Brief History of Ancient Astrology* (Oxford/Malden, MA: Blackwell, 2007), 44.

(δύσις), eighth ‘Death’ (θάνατος), ninth ‘Sun God’ (θεὸς Ἡλίου), tenth ‘Midheaven’ (μεσουράνημα), eleventh ‘Good Daimon’ (ἀγαθὸς δαίμων), twelfth ‘Evil Daimon’ (κακὸς δαίμων). Each place is responsible for a certain area of life: for example, the fourth place represents parents, among other things, and the seventh place marriage (again, among other things).¹⁰

The places vary in effectiveness; the first, fourth, seventh and tenth are called ‘centrepins’ (κέντρα in Greek, *cardines* in Latin, modern ‘angles’) and are considered to be ‘operative’ or ‘productive’ (χρηματιστικός). The second, fifth, eighth and eleventh are ‘post-ascensions’ (ἐπαναφοραί) of the centrepins (called ‘succedent’) and are moderately effective. The fifth and eleventh, because they are in aspect to the Hour-marker (Ascendant) (see below, 1.6, Aspects), are considered to be better than the second and eighth (which make no aspect to the Ascendant). The remaining places, the third, sixth, ninth and twelfth are called ἀπόκλιματα, declining (from the angles) and are the least effective—though the third and ninth, which make aspects to the Ascendant, are considered to be better than the sixth and the twelfth.

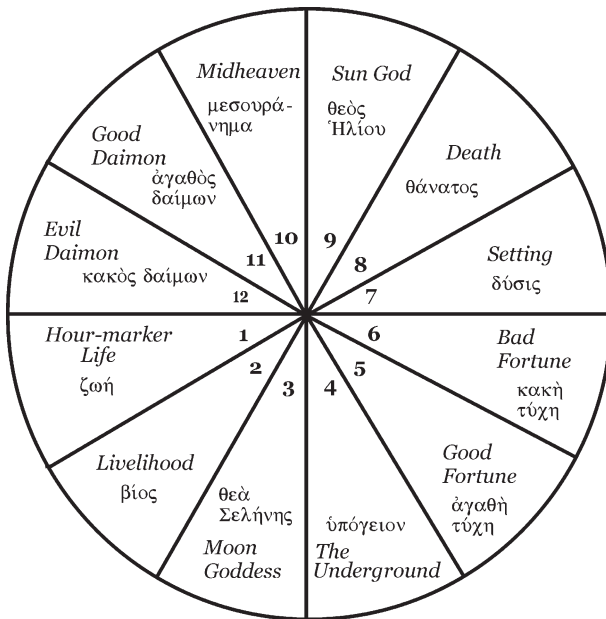

FIGURE I.1 *Places of the chart.*

10 Extensive descriptions of the places may be found in Valens, 11, 5–16; Paulus, chapter 24; Olympiodorus, chapter 23; Firmicus, 11, 19, (KSZ, vol. 1, 61–65 = Monat, vol. 1, 114–18; also Firmicus, *Ancient Astrology: Theory and Practice, Matheseos Libri VIII by Firmicus Maternus*, trans. J. R. Bram (Park Ridge, New Jersey: Noyes Press, 1975; reprint, Mansfield, Notts: Ascella, 1995), 40–42).

The assignment of these places in the astrological chart follows the symmetries so essential in Hellenistic astrology. Geometry and proportion were very important in the systematization of astrology by the Greeks. So the places are even, 30-degree segments of the circle,¹¹ and the signs of the zodiac are 30-degree, even segments of the ecliptic. The signs of the zodiac are arranged in symmetrical ways: as groups of tropical, solid and bicorporeal signs;¹² as groups of fiery, earthy, airy or watery signs (Valens is the first to assign elements to these groups of signs).¹³ These last are called ‘triplicities’ and are involved in one of the dignity systems we shall discuss below.

TABLE 1.1 *Signs of the quadruplicities*

<p><i>Tropical signs: Aries, Cancer, Libra, Capricorn</i> (<i>Solsticial and Equinoctial</i>)</p> <p><i>Solid Signs: Taurus, Leo, Scorpio, Aquarius</i> (<i>Also called Fixed</i>)</p> <p><i>Bicorporeal Signs: Gemini, Virgo, Sagittarius, Pisces</i> (<i>Also called Mutable</i>)</p>

- 11 Such a division derives from the Babylonian practice in which the unequal size of the zodiacal constellations developed into a zodiac of equal 30-degree segments; evidence of this dates to the fifth-century BCE (see F. Rochberg, *The Heavenly Writing: Divination, Horoscopy, and Astronomy in Mesopotamian Culture* (Cambridge: Cambridge University Press, 2004), 130). We have evidence that the earliest extant charts (1st century CE), charts were round in shape, as were the astrological boards used to lay out charts for clients. See Neugebauer and Van Hoesen, *GH*, 18 (No. 15/22, P. Oxy. 235, dated during the reign of Tiberius). See also J. Evans, ‘The Astrologer’s Apparatus: A Picture of Professional Practice in Greco-Roman Egypt’, *JHA* 35 (2004): 1–44. In the Medieval tradition the chart became a square segmented into triangles and rectangles representing the places (however, the concept of even division still applies): for its origins, see J. Thomann, ‘Square Horoscope Diagrams in Middle Eastern Astrology and Chinese Cosmological Diagrams: Were These Designs Transmitted through the Silk Road?’ in *The Journey of Maps and Images on the Silk Road*, ed. Philippe Forêt and Andreas Kaplony (Leiden/Boston: Brill, 2008).
- 12 See the descriptions in Paulus, ch. 1.
- 13 Valens, 1, 2; II, 1. See W. Hübner, *Die Eigenschaften der Tierkreiszeichen in der Antike: ihre Darstellung und Verwendung unter Besonderer Berücksichtigung des Manilius* (Wiesbaden: F. Steiner, 1982), 238. (This text is also useful for the many other ways in which zodiac signs are characterised in different arrangements.)

TABLE 1.2 *Signs of the elemental triplicities*

<p><i>Fire Signs:</i> Aries, Leo, Sagittarius</p> <p><i>Earth Signs:</i> Taurus, Virgo, Capricorn</p> <p><i>Air Signs:</i> Gemini, Libra, Aquarius</p> <p><i>Water Signs:</i> Cancer, Scorpio, Pisces</p>

1.4 *Sect and other Ordering Schemes*

Planets can be sorted in different ways in astrology: by their goodness or badness (benefics and malefics); by their light-giving qualities (luminaries and planets); by their distance as they appear from Earth (Chaldean or Egyptian [Platonic] order). They can also be sorted based on their allegiance to the day or night—and to the rulers of the day and night, the Sun and the Moon: this is called sect. These add to the ways in which the Greeks created a beautiful, symmetrical, organised whole out of their system of astrology. Sect is an important doctrine in Hellenistic astrology and is often crucial in chart interpretation.

Sect (*hairesis* in Greek, which means choice, but also faction), divides the planets into two factions. The nocturnal faction is led by the Moon; the diurnal faction by the Sun. Diurnal planets are happier, more consistent and better and more balanced in their effects when they are placed in a diurnal chart (where the Sun is above the horizon); nocturnal planets, conversely, behave better when in a nocturnal chart. In this way, they align with the natural order of sect.¹⁴

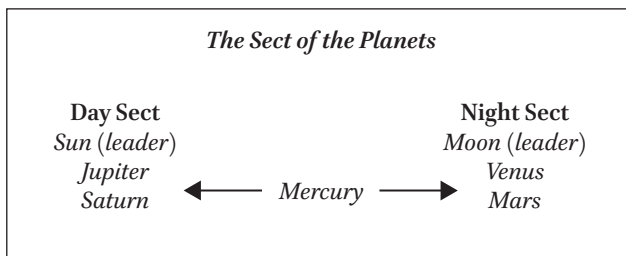
FIGURE 1.2 *Sect.*

14 See the comprehensive article of G. Bezza, 'The Development of an Astrological Term—from Greek *hairesis* to Arabic *hayyiz*', *Culture and Cosmos* 11, no. 1 and 2 (2007): 229–60.

Thus Jupiter and Saturn prefer day charts, with the Sun above the horizon; and the Moon, Venus and Mars prefer night charts, with the Sun below the horizon. Mercury is ambivalent; in some schemes, if it is ahead of the Sun (in earlier zodiacal longitude), it is considered to be diurnal; when behind the Sun it is nocturnal.

Benefic planets are Venus (the lesser benefic) and Jupiter (the greater benefic). Malefic planets are Mars (the lesser malefic) and Saturn (the greater malefic).

The Chaldean order of the planets (based on their distance from earth and/or on their orbital cycles) is (from farthest/longest to nearest/shortest) Saturn, Jupiter, Mars, Sun, Venus, Mercury, Moon. This was the standard order for astrologers. Egyptian (Platonic) order (which Plato uses in *Republic*, x.616e; *Timaeus* 38d) is Saturn, Jupiter, Mars, Mercury, Venus, Sun, Moon.¹⁵ The Chaldean order is used in naming the days of the week in which, e.g., starting with Saturday, Saturn's day, the first hour of the day belongs to Saturn, the second to Jupiter, the third to Mars, the fourth to the Sun, the fifth to Venus, the sixth to Mercury and the seventh to the Moon. The assignments repeat with the eighth hour belonging to Saturn, etc. The scheme is ordered so that the last hour of the day belongs to the planet before the ruler of the next day, so Saturday's hours end with Mars, and then the first hour of the next day, Sunday, belongs to the Sun.

1.5 *Familiarity*

Congruence, equal-ascension and equipollence provide conditions of familiarity between planets. Congruent signs are those ruled (by domicile) by the same planets: e.g. Aries and Scorpio are congruent, because both are ruled by Mars. Equally-ascending signs are those that ascend in the same amount of time (called 'contra-antiscia' in modern astrology). Equipollent signs are those that have the same amount of (seasonal) daylight (called 'antiscia' in modern astrology). Certain signs 'see' each other; and others 'hear' (some 'command' and some 'obey'). See the diagrams overleaf.

1.6 *Aspects*

Geometrical relationships between planets provide ways for them to be in contact with one another. Accepted aspects were the conjunction (0° angular separation), the sextile (60°), the square (90°), the trine (120°) and the opposition (180°); these are called 'Ptolemaic' aspects. They can be either beneficial or difficult: trines and sextiles are considered to be good, but squares and oppositions bad. In observing the places which are called 'daimon' and 'fortune', the 'good' places, the fifth (Good Fortune) and the eleventh (Good Daimon) form, respectively, a trine and a sextile to the Hour-marker, thus reinforcing their goodness and ability to give benefits to the native, whose life as

15 For Chaldean order, see R. Gleadow, *The Origin of the Zodiac* (London: Jonathan Cape, 1968), 183. Macrobius identifies the orders as Egyptian-Platonic and Chaldean in the *Commentary on the Dream of Scipio*, 1, 19.2.

Familiarities/Affiliations

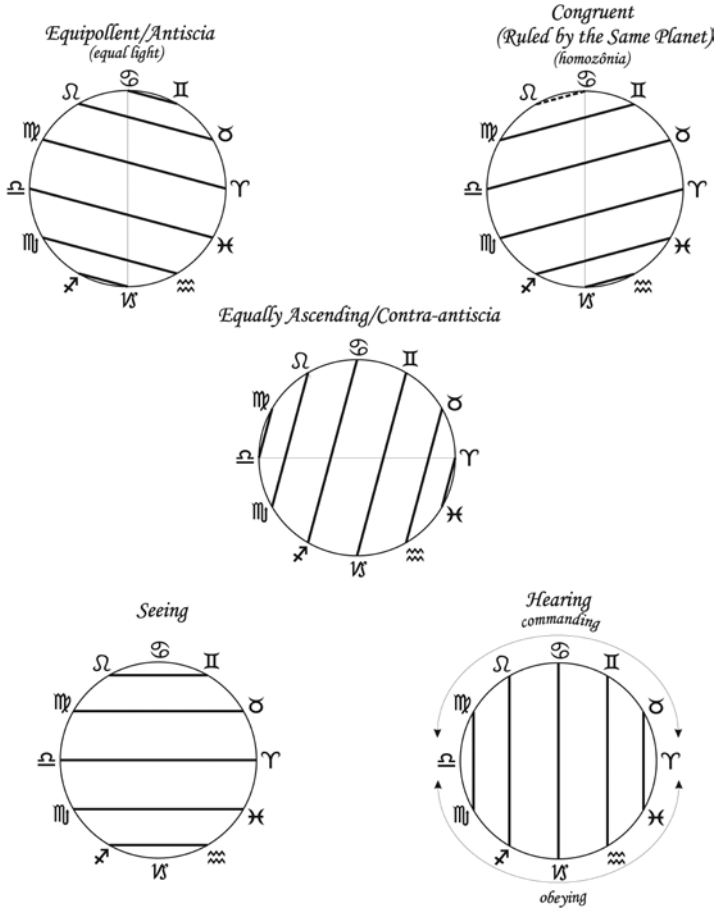

FIGURE 1.3 *Familiarities between signs.*¹⁶

a generalised whole is represented by the Hour-marker. By contrast, the ‘bad’ places, the sixth (Bad Fortune) and the twelfth (Bad Daimon), form no accepted aspect to the Hour-marker and are therefore ‘turned away’ from it.¹⁷ This contributes to these places being unable to produce anything good for the native, even when benefics are in them.

16 All these affiliations may be found in Paulus, chapters 8, 9, 12 and 13.
 17 Any angular separation other than the accepted Ptolemaic one was considered ‘averse’ (ἀπόστροφος) and ‘unconnected’ (ἀσύνδετος). Only planets/signs/places ‘in aspect’ could see each other and thus have a relationship, whether harmonious or inharmonious. Aspects could be effective both by degree (i.e., separated exactly at the angle which makes the aspect), or by sign (called μοιρικῶς and ζφδιακῶς respectively).

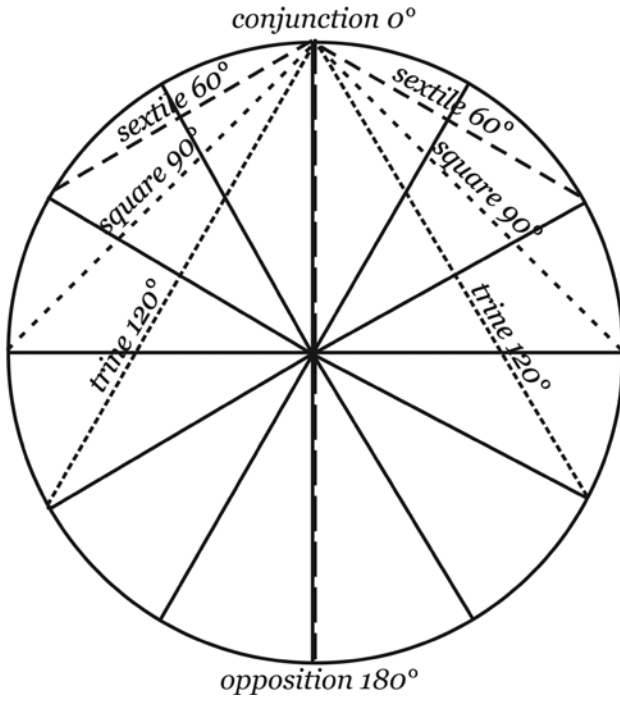

FIGURE I.4 Aspects.

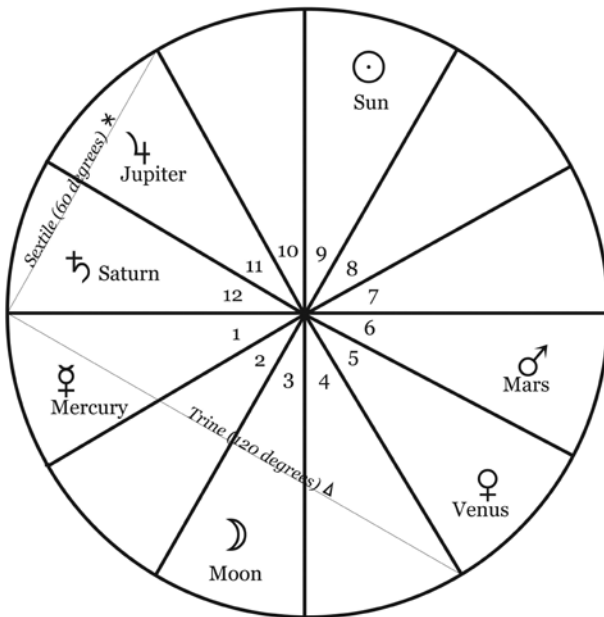

FIGURE I.5 Planetary joys and aspects to the hour-marker.

In addition, the concept of planetary ‘joys’ plays a part in how the Daimon and Fortune places operate. Venus and Jupiter are in their ‘joy’ in the fifth and eleventh places respectively. The concept of planets having ‘joy’ in a certain place of the astrological chart is delineated in the fourth-century *Introduction* of Paulus Alexandrinus (Chapter 24), but the doctrine is older.¹⁸

Whether the reason the benefics were said to ‘rejoice’ in the fifth or eleventh place relates to the previous concept that these places were in harmonious aspect to the Hour-marker,¹⁹ joys still embrace the symmetry of Hellenistic astrology: the benefics each take a ‘good’ place, Venus being associated with Fortune and Jupiter being associated with Daimon. And of course, in contrast but still symmetrical, the malefics, Mars and Saturn, are then said to rejoice respectively in the sixth and the twelfth. In complementarity to the doctrine of planetary joys, diurnal planets (Sun, Jupiter and Saturn) rejoice in places above the horizon, and nocturnal planets (Moon, Venus and Mars) in places below it.²⁰

1.7 *Dignities*

Using the word ‘dignity’ to describe the various rulerships of planets in zodiac signs is an anachronism in Hellenistic astrology;²¹ I use it for convenience here to refer to houses, exaltations, triplicities, bounds (terms) and faces. The most well-known rulership is that which the ancients called ‘house’, e.g., Aries and Scorpio are the houses of Mars, Taurus and Libra are the houses of Venus, etc.

18 See W. Hübner, ‘Les divinités planétaires de la *Dodécatropos*’, in *Les astres: actes du colloque international de Montpellier, 23–25 mars 1995*, 2 vols., vol. 1: *Les astres et les mythes, la description du ciel*, ed. Béatrice Bakhouché, Alain Maurice Moreau, and Jean-Claude Turpin (Montpellier: Université Paul Valéry, 1996), 307–17. Manilius has his own variant system of planetary joys which is different from the standard one discussed here. See also D. Houlding, *The Houses: Temples of the Sky* (Mansfield, Notts: Ascella, 1998), esp. 35–38. Valens makes a few references to a planet being in a place where it ‘rejoices’ (11, 32) but does not describe the system. In 111, 5 he speaks of planets rejoicing when placed in the chart according to their sect, and that Venus rejoices in the Hour-marker and Midheaven (this may refer back to Manilius’s system of planetary joys). Other planets rejoice in the Hour-marker or Setting Place (Descendant). Antiochus of Athens also mentions a system of planetary joys that is more generalised than the standard one outlined by Paulus; see Antiochus, *Thesaurus*, ch. 44, *CCAG* I, 159.20–29.

19 Houlding, *Houses*, notes this possibility, 42.

20 This is part of the doctrine of sect (*hairesis*); see above, 1.4 and Fig. 1.2, 403.

21 Bezza, ‘*Hairesis* to *ḥayyiz*’, 239–40.

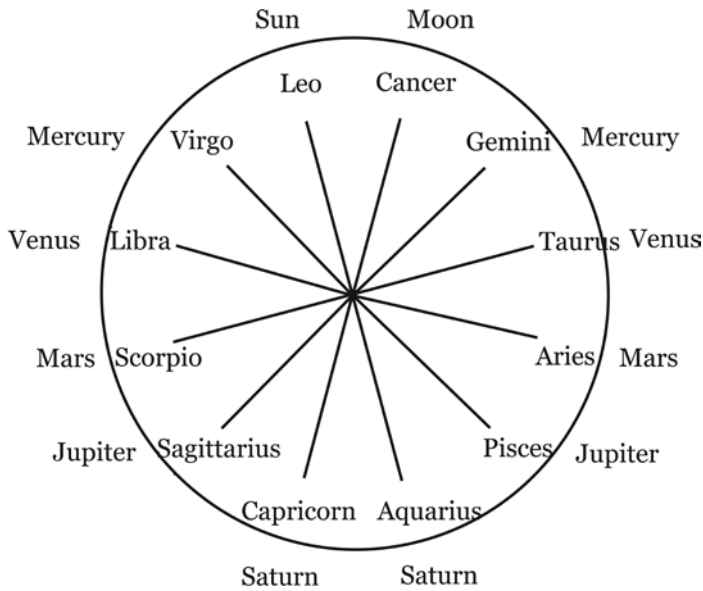

FIGURE 1.6 *Planetary house rulers.*

The luminaries rule one sign apiece, and the other five planets each rule two signs, in order from Leo and Cancer as in Figure 1.6. Again, the symmetry so prized by the Greeks is evident. Exaltation is another system of rulership: the Sun is exalted in Aries, Moon in Taurus, Jupiter in Cancer, Mercury in Virgo (where it is also house ruler), Saturn in Libra, Mars in Capricorn and Venus in Pisces.²²

The doctrine of triplicity rulers assigns certain planets the rule of certain signs based on their elements (fire, earth, air and water) and on their sect. Triplicity lords become important in estimating the conditions at different times in the life of the native. The first triplicity lord is the lord of the sect, e.g. in a day chart, if the Sun is in a fire sign, then he is the first triplicity lord; in a night chart, if the Moon is in an air sign, then Mercury is the first triplicity lord. The position and sign of the triplicity lords predict the condition of that time.

TABLE 1.3 *Triplicity lords*

Fire	Earth	Air	Water
(Day) Sun	(Day) Venus	(Day) Saturn	(Day) Venus
(Night) Jupiter	(Night) Moon	(Night) Mercury	(Night) Mars

²² See the descriptions in Antiochus, *Thesaurus*, 7, CCAI, 147–48.

Bounds (*ῥοια*, *termini* or *finis* in Latin, also called ‘terms’ in English) are specific degrees of signs assigned to particular planets. A number of different bound systems were used in Hellenistic astrology, but the most common is the system of Egyptian bounds. Bounds are utilised in some length of life determinations. Faces divide each sign into three segments of ten degrees, each ruled by a planet beginning with Mars ruling the first face of Aries, and continuing the rulerships in the Chaldean order of the planets (Saturn, Jupiter, Mars, Sun, Venus, Mercury, Moon). Overleaf is a table of dignities, including the Egyptian bounds and the faces.

2 Astrological Techniques

2.1 Lots

Lot calculation was briefly described in the Introduction. The calculation of a lot is usually dependent on whether the chart is diurnal or nocturnal; in other words, on its sect. When we take the arc distance between two planets or points and project it, the direction of the projection functionally depends on the chart’s sect.

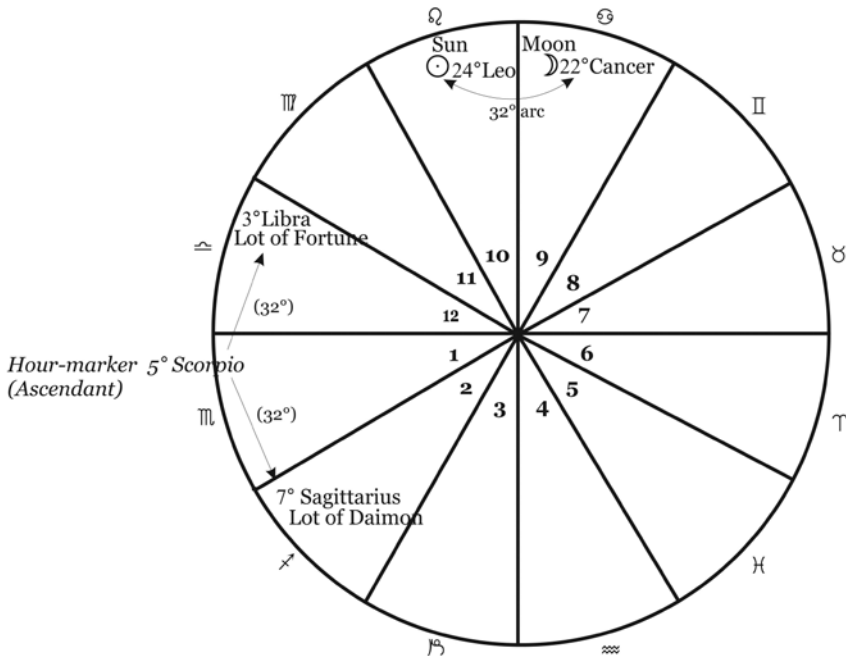

FIGURE 1.7 The Lots of Fortune and Daimon in a diurnal chart.

TABLE I.4 Dignities with houses, exaltations, Dorothean triplicities, Egyptian bounds and decanic faces²³

Sg.	Houses of the Planets	Exaltation of the Planets	Triplicity Rulers Day Night	The Terms of the Planets According to the Egyptians						The Faces of the Planets			Detr.	Fall
♄	♂ D.	☉ 19	☉ 24	24 6	♀ 12	♃ 20	♂ 25	♃ 30	♂ 10	☉ 20	♀ 30	♀	♃	
♃	♀ N.	♃ 3	♀ 20	♀ 8	♃ 14	24 22	♃ 27	♂ 30	♃ 10	♃ 20	♃ 30	♂		
♂	♃ D.	♂ 3	♃ 15	♃ 6	24 12	♀ 17	♂ 24	♃ 30	24 10	♂ 20	☉ 30	24	L	
♁	♃ N. D.	24 15	♀ 5	♂ 7	♀ 13	♃ 19	24 26	♃ 30	♀ 10	♃ 20	♃ 30	♃	♂	
♂	☉ D. N.		☉ 24	24 6	♀ 11	♃ 18	♃ 24	♂ 30	♃ 10	24 20	♂ 30	♃		
♁	♃ N.	♃ 15	♀ 20	♃ 7	♀ 17	24 21	♂ 28	♃ 30	☉ 10	♀ 20	♃ 30	24	♀	
♁	♀ D.	♃ 21	♃ 15	♃ 6	♃ 14	24 21	♀ 28	♂ 30	♃ 10	♃ 20	24 30	♂	☉	
♁	♂ N.		♀ 5	♂ 7	♀ 11	♃ 19	24 24	♃ 30	♂ 10	☉ 20	♀ 30	♀	♃	
♂	24 D.	L 3	☉ 24	24 12	♀ 17	♃ 21	♃ 26	♂ 30	♃ 10	♃ 20	♃ 30	♃	I	
♂	♃ N.	♂ 28	♀ 20	♃ 7	24 14	♀ 22	♃ 26	♂ 30	24 10	♂ 20	☉ 30	♃	24	
♁	♃ D.		♃ 15	♃ 7	♀ 13	24 20	♂ 25	♃ 30	♀ 10	♃ 20	♃ 30	☉		
♁	24 N.	♀ 27	♀ 5	♀ 12	♀ 16	♃ 19	♂ 28	♃ 30	♃ 10	24 20	♂ 30	♃	♃	

23 Table design by Robert Hand. The degrees given in this table must be read as the ending longitude and should be interpreted as being an exact longitude X°00'00.00".

In Figure 1.7, the arc to form the Lot of Fortune is taken from Sun to Moon by day. Using the shorter arc between the two planets (in this case, 32°), one projects it from the Ascendant in the same direction it was obtained, i.e. from Sun to Moon, clockwise. The 32° segment thus goes clockwise (in diurnal order) from the Ascendant to create the Lot of Fortune. The Lot of Daimon, which by day takes the arc from Moon to Sun, then goes in the opposite direction, in zodiacal, anti-clockwise motion. In the calculation of these ‘mirrored’ lots, they will always be projected from opposite sides of the Ascendant.

Most lots use the Ascendant as a projection point, but there are a few exceptions. The lots discussed in this book, though, are not in the latter category.

2.2 *Planetary Periods*

Planets are associated with different periods of years in prediction techniques. Commonly used periods are least (minor), middle and maximum. The minor periods are mostly based on recurrence cycles with the Sun.²⁴ These are discussed in Vettius Valens, IV, 6 (see Chapter Nine, 322 and n. 61). In the Egyptian bounds system, the amount of bounds for each planet adds up to the maximum (final) years for that planet (see Paulus, ch. 3). Mean years are mentioned in Valens, III, 13.

2.3 *Katarchic Astrology*

Much of Hellenistic astrological writing centres on natal astrology (genethliology). But there is also a branch of astrology called ‘katarchic’, in which charts are chosen at astrologically propitious times for events or rituals (these are also called ‘elections’); charts

TABLE 1.5 *Years of the planets*

Planet	Minor (Least)	Middle (Mean)	Maximum (Final)
☉	19	69.5	120
☽	25	66.5	108
♃	20	48	76
♀	8	45	82
♂	15	40.5	66
♄	12	45.5	79
♅	30	43.5	57

24 See Neugebauer and Van Hoesen, *GH*, 10–11.

of events after they have occurred are analyzed for outcomes; and charts are created for the moment of a question about an event, then analysed for outcomes based on the moment of the question (also called ‘interrogations’). The propitious time, or opportunity moment, is *kairikos* (see Chapter One, 3,5, 40–41; Chapter Seven, 1.2, 247–48).

3 Terminology

3.1 *Aphetēs*

The *aphetēs* has been traditionally understood as a kind of starting point.²⁵ LSJ, s.v., defines it as ‘prorogator’—a term which, though technically correct, hardly conveys a meaning to the modern ear. None of these capture the real sense of ἀφότης. It is, in truth, a ‘releaser’ (coming as it does from the verb ἀφίημι, literally, ‘send away from’).²⁶ In the chart, planets and points which are aphetic are, in a way, like bows releasing an arrow aimed at a certain spot; which kind of bow depends on the questions asked of the chart. There are numerous systems in which aphetic points are employed.

3.2 *Melothesia*

Astrological melothesia assigns body parts to planets, signs or even lots.²⁷ It is a fairly common practice in Hellenistic astrology, and continued in popularity in the Middle Ages. In this book, melothesia is discussed in Chapter Four (P. Michigan inv.1, 149) and Chapter Nine (Valens, 11, 37)

3.3 *Moirā*

The Greek word translated as ‘fate’ in this book is εἰμαρμένη, literally meaning ‘that which has been allotted’ (from the verb μείρομαι).²⁸ Μοῖρα, another noun often translated as ‘fate’, also comes from *meiromai*. *Moirā*’s first definition in LSJ is a ‘portion’, as of land;²⁹ in other words, a physical and material expression of allotment. In Greek astrology, of course, *moira* is simply the word for a degree of the zodiac—but, perhaps not so simply, it may point out a relationship between fate and the degrees

25 E.g. Bouché-Leclercq, *AG*, 415: ‘points de départ’; Neugebauer and Van Hoesen, *GH*, 12: ‘starter’.

26 For more on the concept of ἀφότης as releaser, see R. Schmidt in *Vettius Valens. The Anthology Book IV*, trans. R. Schmidt (Berkeley Springs, WV: Golden Hind Press, 1996), Translator’s Preface, xiii–xvi.

27 For more on the different kinds of melothesia, see Bezza, *AM*, vol. 2, 677, 680, 722–32, 741–44.

28 LSJ, s.v.

29 *Ibid.*, s.v. μοῖρα, 1.2.

of the zodiac—the individual ‘portions’ of fate where planets, the Hour-marker and the Midheaven just happen to fall. It may be just a coincidence that this is the word the Greek astrologers decided to use for ‘degree of the zodiac’ but, if it has nothing to do with any kind of fate, why not use a word like *μερίς* (a part, portion, division)³⁰ or *βαθμός* (step, threshold, degree)³¹ which have no connection to fate in their definitions?³² Jane Harrison has remarked that the Moirai and the Horai (the Hours), all of whom are the daughters of Zeus and Themis, represent both spatial and temporal allotments or apportionments.³³ *Moirai* appears to have been first used as a technical term, dividing portions of the sky into even segments, by Aratus, who calls a twelfth part of the zodiacal circle a *moira*.³⁴ Hipparchus is the first to use *moira* as one ‘portion’ (i.e. degree) of a zodiac sign,³⁵ and Geminus defines it as a thirtieth part of a sign.³⁶ But there is even earlier evidence of *moira* as a portion of the night sky which shows the passage of time, in Homer: ‘As the stars have gone forward, and more than two portions of the night have passed, only a third portion is left.’³⁷ To Homer, of course, *moira* is also fate.

This connection between a degree of the zodiac and fate is explicitly seen in at least one example in Late Antiquity. Censorinus, writing in 238 CE, in *De die natali*, makes

30 Ibid., s.v.

31 Used by Valens, I, 16.4 (Pingree, 30.7–9), as meaning 15 degrees of the zodiac, but the question is still relevant: why was *moira* chosen in the first place?

32 See also the argument of R. Schmidt, ‘Translator’s Preface’, in Vettius Valens, *The Anthology, Books I–VII*, trans. Robert Schmidt, 6 vols. (Berkeley Springs, WV/Cumberland, MD: Golden Hind Press, 1993–2001), here *The Anthology Book I*, xix; and idem, ‘Facets of Fate’, *The Mountain Astrologer* (Dec.–Jan. 1999–2000): 83–94, 106, 126.

33 J. E. Harrison, *Themis: A Study of the Social Origins of Greek Religion* (Cleveland/New York: World Publishing Company, 1927, repr. 1962), 477. But the Moirai are the daughters of Necessity in the Myth of Er (*Republic* x.617c).

34 *Phaenomena*, ll. 560, 581, 716, 721, 740: cf. Aratus, *Phaenomena*, ed., trans. and comm. Douglas Kidd (Cambridge: Cambridge University Press, 1997), and Kidd’s commentary on line 560, 377–78.

35 See Hipparchus, *Hipparchi in Arati et Eudoxi phaenomena commentariorum libri tres*, ed. and trans. Karl Manitius, (Leipzig: Teubner, 1894); the *Index verborum*, 339, has, for μοίρα, ‘gradus i.e. tricesima pars signi, passim . . .’.

36 *Introduction to the Phaenomena*, I, 6: ‘Again, each of the twelfth-parts is divided into 30 parts, and the one section is called a degree (*moira*), so that the whole circle of the zodiac signs (*zōidia*) encompasses 12 zodiac signs, and 360 degrees (*moirai*).’ Geminus, *Introduction aux phénomènes*, ed. and trans. Germaine Aujac, (Paris: Les Belles Lettres, 1975), 2: Πάλιν δὲ ἕκαστον τῶν δωδεκατημορίων διαιρεῖται εἰς μέρη λ, καὶ καλεῖται τὸ ἐν τμημα μοίρα, ὥστε τὸν ὅλον κύκλον τῶν ζωδίων περιέχειν ζῶδια μὲν ιβ, μοίρας δὲ τξ. Of course, by the time of Geminus, the Hellenised system of astrology was well underway.

37 *Iliad*, x.252–3 (Allen): ἄστροα δὲ δὴ προβέβηκε, παρόιχων δὲ πλέων νύξ / τῶν δύο μοιράων, τριτάτη δ’ ἔτι μοίρα λέλειπται.

a specific correlation between the Moirai who are the Fates and the *moirai*/degrees of the zodiac: ‘There are thirty of these “little parts” in one zodiac sign, so a total of 360 in the whole zodiac. The Greeks call these μοῖραι, “lots”, clearly because they call the goddesses of fate “the Moirai”. In fact, the “little parts” are like fates to us, for the one rising when we are born has the greatest power over us.’³⁸

3.4 *Thema mundi*

The astrological birthchart of the world. It was not considered to be a ‘real’ chart, but a symbolic representation of planets in their houses. A common version appears in Firmicus, III, 1 (KSZ, I, 91). The *thema mundi* is discussed more fully in Chapter Five, 3.2.

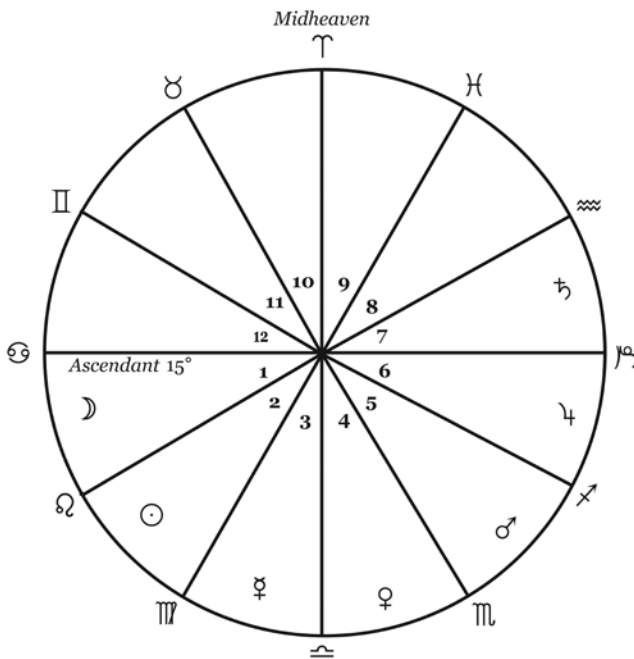

FIGURE I.8 *Traditional thema mundi, as in Firmicus.*

38 Censorinus, *De die natali*, 8.5 (Sallmann): ‘sunt autem hae particulae in unoquoque signo tricena, totius vero zodiaci numero CCCLX. has Graeci μοῖρας cognominarunt eo videlicet, quod deas fatales nuncupant Moeras, et eae particulae nobis velut fata sunt; nam qua potissimum oriente nascamur plurimum refert.’ See also Censorinus, *Censorinus: The Birthday Book*, trans. Holt. N. Parker (Chicago/London: University of Chicago Press, 2007), 13.

Appendix 2.A: Manilius, *Astronomica*: Eleventh and Fifth Places

Eleventh Place, Book 2.881–890

at, quae fulgentis sequitur fastigia caeli
proxima, neve ipsi cedat, cui iungitur, astro
spe melior, palmamque petens victrixque priorum
altius insurgit: summae comes addita finis,
in peiusque manent cursus nec vota supersunt.
quocirca minime mirum, si proxima summo
atque eadem inferior¹ Fortunae sorte dicatur
cui titulus Felix. Censum sic proxima Graiae
nostra subit linguae vertitque a nomine nomen.
Iuppiter hac habitat: venerandam crede regenti.

But what follows nearest to the height of gleaming heaven,
So that it may not yield to that constellation to which it is joined
It soars up higher, being better because of its hope,
And seeking the victory palm and triumphant over prior ones,
Having been added as a companion of the highest aim;
But into the worse the courses flow, and its wishes do not survive.
It is, therefore, small wonder, if the [region] nearest the summit,
Though lower than it, is described by the portion of Fortune
Which is called 'Happy'. Thus is our closest approximation
To the Greek tongue, which renders this name for theirs.
Jupiter dwells here: believe that its ruler makes it revered.

Fifth Place, Book 2.891–904

huic in perversum similis deiecta sub orbe
imaque summersi contingens culmina mundi,
adversa quae parte nitet, defesssa peracta
militia rursusque novo devota labori
cardinis et subitura iugum sortemque potentem

1 Following Hübner, *Die Dodekatropos*, 52 (he follows Bonincontri), reading 'inferior' for Goold's 'integrior'.

nondum sentit onus mundi, iam sperat honorem.
 Daemonien memorant Grai, Romana per ora
 quaeritur inversus titulus. sub corde sagaci
 conde locum numenque loci nomenque potentis,
 quae tibi posterius magnos revocentur ad usus.
 hic momenta manent nostrae plerumque salutis
 bellaque morborum caecis pugnancia telis,
 viribus ambiguam geminis casusque deique
 nunc huc illuc sortem mutantis utraque.

Akin to this is its inverse, cast down beneath the earth
 And bordering the deep pinnacle of the sunken world,
 Which shines from the opposite part, wearied from completion
 Of its service, and again doomed to new drudgery,
 About to shoulder the yoke of the cardine and its powerful allotment,
 Not yet does it feel the burden of the world, but soon hopes for honour.
 The Greeks speak of *Daimonie*; in Roman speech
 A transposed label is lacking. Keep in your wise heart
 The place and its divine authority, and its powerful name,
 Which later for you may be put to great use.
 Here often wait the critical moments of our health,
 And the wars of diseases fought with concealed weapons,
 Wherein are engaged the twin forces of chance and god,
 Affecting this uncertain portion on either side,
 Now for better, now for worse.

(My translations following Goold in some respects.)

Appendix 2.B: Paulus Alexandrinus, *Introduction: Fifth and Eleventh Places*

Chapter 24

Boer, 57.6–13:

Τὸ δὲ πέμπτον ἀπὸ ὠροσκόπου καλεῖται Ἀγαθὴ Τύχη, Ἀφροδίτης τόπος ὑπάρχων, ἐν ᾧ καὶ γενόμενος ὁ τῆς Ἀφροδίτης ἀστήρ παρὰ πάντας τοὺς ἀστέρας ἐν τούτῳ τῷ τόπῳ χαίρει. ἔστι δὲ ἐπαναφορὰ τοῦ ὑπογείου κέν-
[10] τρου καὶ σημαίνει τὸν περι τέκνων λόγον. ἐν δὲ τούτῳ τῷ ζῳδίῳ οἱ μὲν ἀγαθοποιοὶ χαίρουσι καὶ εὐτεκνίας διδόνασιν, οἱ δὲ κακοποιοὶ ἐν τούτῳ τῷ τόπῳ ἀναιρετικοὶ τέκνων γίνονται.

The fifth from the Hour-marker is called *Good Fortune*, being the place of Aphrodite, in which, when the star of Aphrodite comes to be in this place, she rejoices more than all the [other] stars. It is the post-ascension of the Underground centrepin [10] and signifies the reckoning about children. In this zodiac sign the benefics rejoice and give fruitfulness of children, but the malefics in this place come to be destructive of children.

Boer, 68.5–70.10:

[5] Τὸ δὲ ἐνδέκατον ἀπὸ ὠροσκόπου Ἀγαθὸς Δαίμων καλεῖται, τόπος Διὸς ὑπάρχων. ἐν γὰρ τούτῳ τῷ τόπῳ παρατυχῶν ὁ τοῦ Διὸς χαίρει παρὰ πάντας τοὺς ἀστέρας. σημαίνει δὲ τὸν περι συστάσεως καὶ προστασίας λόγον, πρὸς τούτοις δὲ καὶ ἀγαθῶν ἐλπίδων ἔστι σημαν-
[10] τικός.

Ἐν δὲ τούτῳ τῷ τόπῳ ὁ ἥλιος τυχῶν πατρὸς ἐνδόξου καὶ πλουσίου τὸν γεννηθέντα δείκνυσι, καὶ κατὰ τὴν τῶν [p. 69] χρόνων πρόβασιν εὐδαίμονα καὶ εὐπερίηκτον αὐτὸν ποιήσει.

Ἡ δὲ Σελήνη ἐπὶ τούτου τοῦ τόπου τυχούσα καὶ μάλιστα νυκτερινῆς οὔσης τῆς γενέσεως μητρὸς ἐνδόξου [5] καὶ πλουσίας καὶ εὐπόρου ποιήσει, καὶ τὸν γεννηθέντα εὐπορον καὶ εὐσχήμονα δείκνυσιν, ἐπὶ τὴν συναφὴν πρὸς τινα τῶν ἀγαθοποιῶν ἀστέρων ποιήσεται.

Ὁ δὲ τοῦ Κρόνου ἐπὶ τούτῳ τοῦ τόπου τῆς αἰρέσεως

ᾧν προβαιόντων τῶν χρόνων τὰ τέλεια κτωμένους ἀποτε-
 [10] λει, ἀργότερους δὲ ταῖς πράξεσι καὶ ταῖς ἐπιβολαῖς ποιήσει.
 Ὁ δὲ τοῦ Διὸς τὸν ἐνδέκατον τόπον εἴτε νυκτὸς εἴτε
 ἡμέρας ἐπίσχω τὸν βίον ἐπαύξει καὶ ἐν προφανείᾳ καὶ
 ἐν περικτῆσει τίθησι καὶ ἐπιδόξους ποιήσει καὶ ἐπικρα-
 τεστέρους τῶν ἐχθρῶν καὶ ὡς ἐπὶ τὸ πλεῖστον ἀσινεῖς
 [15] καὶ ἀπαθειὲς τοὺς γενομένους συντηρήσει. ἐπὶ δὲ νυκτε-
 ρινῆς γενέσεως ὁ τοῦ Κρόνου τὸν τόπον τοῦτον ἐπέχων
 τῶν προκτηθέντων μειώτης γίνεται, ἀργοπράκτους δὲ
 καὶ δυσεπιβούλους καὶ δυσπερικτήτους ποιήσει.
 [20] Ὁ δὲ τοῦ Ἄρεως τὸν ἐνδέκατον τόπον ἀπὸ ὠροσκόπου
 ἐπίσχω ἐπὶ ἡμερινῆς γενέσεως ἀπόκτησιν βίου καὶ ἀπο-
 βολὰς πραγμάτων καὶ τόπων μεταβολὰς καὶ ἀντιπτωμά-
 των δείκνυσι, καὶ τὸν περὶ τέκνων κακίζει λόγον. ἐπὶ δὲ
 νυκτερινῶν γενέσεων πολλῶν ἀγαθῶν ὑπαρξίν ἐπιτελεῖ,
 καὶ ὑπὸ ὄχλων τιμῆς καταξιουμένους καὶ παρ' ὑπερέχουσι
 [25] γνωστοὺς ποιήσει.
 [p. 70] Ὁ δὲ τῆς Ἀφροδίτης ἐκεῖσε χρηματίσας εὐγάμους καὶ
 καλοβίους, εὐτάκτους καὶ ἀνενδεεῖς τοῦ βίου καὶ κατὰ
 τὴν τῶν χρόνων πρόβασιν εὐτυχοῦντας ποιήσει, ἐπὶ ἀνπερ
 τῆς τῶν κακοποιῶν ἀκτίνος ἀκατόπτευτος τύχη.
 [5] Ὁ δὲ τοῦ Ἑρμοῦ εἴτε ἐπὶ ἑώας εἴτε ἐπὶ ἑσπερίας ἀνα-
 τολῆς ἐπὶ τούτου τοῦ τόπου τυχῶν ἀπὸ γραμμάτων δια-
 ζῶντας ποιήσει καὶ τὰς πράξεις ἀφθόνους συντηρήσει καὶ
 κατὰ τὴν τῶν χρόνων πρόβασιν τὸν βίον ἐπαύξοντας ἀπο-
 δείκνυσιν, ὅτε δὲ καὶ ἀρετῆς αἴτιος καὶ ἐπιστήμης μετέ-
 [10] χοντας ἀποτελέσει.

[5] The eleventh from the Hour-marker is called *Good Daimon*, being the place of Zeus. For when the [star] of Zeus happens to be present in this place, it rejoices beyond all the other stars. It signifies the reckoning about alliance and patronage, and in addition to these is indicative of good hopes.

[11] When the sun happens to be in this place, it shows one born of an esteemed and wealthy father, and will make him, as [p. 69] time progresses, fortunate and successful in acquiring property.

When the Moon happens to be in this place, especially in a nocturnal birth, she will make [one born] of an esteemed, [5] wealthy and well-off mother, and it shows the native well-provided for and well-bred, whenever it makes an application for itself with one of the benefic stars.

When the [star] of Kronos is on this place in sect, as time progresses it brings about those who achieve their ends, but it will make them [10] more lazy in achievements and enterprises. [*The next sentence is lines 15–18 of p. 69*] When the star of Kronos occupies this place in a nocturnal birth, it causes diminution of what was owned before, and it will make those who are slothful, unsuccessful and unable to acquire property.

When the [star] of Zeus occupies the eleventh place either by night or day, it increases the manner of living and puts it in eminence and acquisition; and it will make those who are glorious and have the upper hand over enemies. And for the most part [15] it will maintain the natives free from injury and suffering.

[20] When the [star] of Ares occupies the eleventh place from the Hour-marker in a diurnal birth, it shows loss of lifestyle, loss of fortunes, changes of positions, and accidents, and it afflicts the reckoning concerning children. But for nocturnal births it brings the reality of many good things to pass, and it will make those held in honour by the masses and [25] those known by their prominence.

[p. 70] When the [star] of Aphrodite has dealings there she will make good marriages and fine living, well-ordered and wanting for nothing in life, and fortunate as time progresses, as long as it does not happen to be in a baleful aspect with the ray of the malefics.

[5] When the [star] of Hermes happens to be on this place either at morning or evening rising, it will make those who make a living through writings, and will maintain plenty of business. And as time progresses, it will point out those who increase their lifestyle, and sometimes it will be a cause of virtue and bring about [10] those participating in knowledge.

Appendix 3.A: Portions of the Isis Aretalogy from Kyme

Taken from Plate xv (M [Memphis] Text) in Vanderlip, *The Four Greek Hymns of Isidorus and the Cult of Isis*; the same in Totti, *Ausgewählte Texte der Isis- und Sarapis-Religion*, 2–4.

- 4 Ἐγὼ νόμους ἀνθρώποις ἐθέμην καὶ ἐνομοθέτησα ἃ οὐδεὶς δύναται μεταθεῖναι.
9 Ἐγὼ εἰμι ἡ ἐν τῷ τοῦ Κυνὸς ἄστρῳ ἐπιτέλλουσα.
12 ἐγὼ ἐχώρισα γῆν ἀπ' οὐρανοῦ.
13 ἐγὼ ἄστρων ὁδοὺς ἔδειξα,
14 ἐγὼ ἡλίου καὶ σελήνης πορείαν συνεταξάμην.
16 ἐγὼ τὸ δίκαιον ἰσχυρὸν ἐποίησα.
28 ἐγὼ τὸ δίκαιον ἰσχυρότερον χρυσοῦ καὶ ἀργυρίου ἐποίησα.
29 ἐγὼ τὸ ἀληθὲς καλὸν ἐνομοθέτησα νομιζέσθαι.
35 ἐγὼ τοῖς ἄδικα πράσσουσι τειμωρίαν¹ ἐπιτίθημι.
38 παρ' ἐμοὶ τὸ δίκαιον ἰσχύει.
44 ἐγὼ ἐν ταῖς τοῦ ἡλίου αὐγαῖς εἰμι,
45 ἐγὼ παρεδρεύω τῇ τοῦ ἡλίου πορείᾳ.
46 ὃ ἂν ἐμοὶ δόξη, τοῦτο καὶ τελεῖται.
47 ἐμοὶ πάντ' ἐπείκει.
48 ἐγὼ τοὺς ἐν δεσμοῖς λύω.
52 ἐ(γ)ὼ εἰμι ἡ θεσμοφόρος καλουμένη.
55 ἐγὼ τὸ ἱμαρμένον² νικῶ,
56 ἐμοῦ τὸ εἱμαρμένον ἀκούει.
57 Χαίρει Αἴγυπτε θρέψασά με.

- 4 I set down laws for men, and what I have enacted no one is able to change
9 I am she who arises in the Dog-Star
12 I who separated earth from heaven
13 I pointed out the paths of the stars,
14 I arranged the courses of the sun and moon.
16 I made the just strong
28 I made the just stronger than gold and silver
29 I ordained the true to be deemed beautiful

1 τιμωρίαν in Totti.

2 εἱμαρμένον in Totti.

- 35 I imposed retribution on those acting unjustly
38 With me the just prevails
44 I am in the rays of the sun
45 I accompany the course of the sun.
46 Whatever I determine, this too is accomplished
47 For me everything gives way
48 I free those in bonds
52 I am she who is called lawgiver
55 I conquer fate
56 Fate obeys me
57 Hail Egypt, who nourished me

Appendix 4.A: Prayer from the *Hygromanteia* of Solomon

CCAG VIII/2, 157.8–19:

Προσευχὴ τῆς Σελήνης.

Δέσποτα κύριε, ὁ δεσπόζων ζώντων τε καὶ νεκρῶν, ὁ ἐν σοφίᾳ
[10] κατασκευάσας τὸν ἄνθρωπον, ἵνα δεσπόζη τῶν ὑπὸ σοῦ γενομένων
κτισμάτων ἐν ὀσιότητι καὶ συνέσει, συνέργησόν μοι, ἵνα δυνηθῶ ὁ
δοῦλός σου χάριν λαβεῖν καὶ ὑποτάξαι τὸν πλανήτην τὴν Σελήνην καὶ
τελειῶσαι τὸ ἔργον, ὃ ἐπεχειρίσθην· ὀρκίζω σε Σελήνην, τοῦ οὐρανοῦ
ῥωριστάτη πορφύρα καὶ τῆς νυκτὸς παραμυθία. ὀρκίζω σε εἰς τὴν
[15] ὁδὸν σου καὶ εἰς τὴν ἀνακαίνισίν σου καὶ εἰς ἀναμετρήτους βαθμούς,
ἐν οἷς κατέρχει, καὶ εἰς τὰ ὀνόματα ταῦτα· Σαβαήλ, Βοαήλ, Ὠνιτζήρ,
Σπαροῦ, Σωρτήρχα, Γαβήδ, Οὐτουπῶν, Καιπολής, Γωμεδὴν, Μαρηβάτ.
εἰς ταῦτα σε ὀρκίζω, Σελήνη, ἵνα μοι ὑποκλίνῃς τὴν χάριν σου καὶ τὴν
ἐνέργειάν σου εἰς τὴν δουλείαν ταύτην, ἐν ᾗ ἐπιχειρίζομαι.

Prayer of the Moon

Lord master, lord of the living and the dead, [10] you who made man in wisdom, so that he may be master over the creatures created by you in piety and intelligence, cooperate with me, so that I your slave may be able to receive grace, and subordinate the planet Moon, and accomplish the work which has been undertaken. I entreat you, Moon, ripest blushing fruit of heaven and consolation of the night. I entreat you by [15] your path, and by your renewal, and by the measured steps in which you come down, and by these names: Sabaël, Boaël, Ōnitzēr, Sparou, Sörtërcha, Gabēd, Outoupōn, Kaipolēs, Gōmedin, Marēbat. By these I entreat you, Moon, to incline to me your grace and energy in this service that I am undertaking.

Rationale for choice of *oikodespotēs*:

The chart is nocturnal. The Moon in Taurus is in the first place, while the Sun is cadent (in the sixth). The Moon is in the east and rising; the Sun in the west and descending. A nocturnal chart favours the Moon for the predominator, and it is well-placed. Moon is probably the predominator; its ruler is Venus, but we cannot determine the bound-lord (following the Valens/Dorotheus rule for the *oikodespotēs*, or Porphiry's *co-oikodespotēs*) because no degrees are given for the planetary positions or the Ascendant. But perhaps the creator of the chart is following the house-lord formula for the *oikodespotēs*, as Porphiry suggests.

2. No. 81 in *GH*

P. Lond. 130

Chart of 'Hermon', drawn

by Titus Pitenius

Dated to 31 March 81 CE

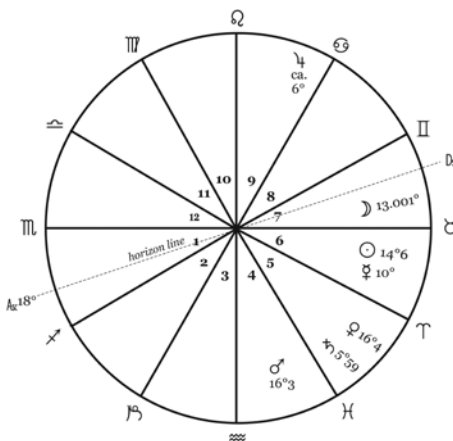

Text and Translation

Col. vii

(lines 155–156, 165–184 omitted)

157. στιλβων δ ο του ερ

158. μου αστηρ κριου ε

159. πετρεχε μοιρας στε

160. ρεας δεκα: περιγει

161. ος: προ επτα φασιν

162. πεποιημενος: δι

163. ο οικοδεσποτησει

164. το διαθεμα

157. The glittering one, the

158. star of Hermes,

159. extended to ten

160. full degrees of Aries: at

161. perigee: having made its appearance

162. seven [days] before:

163. on account of which it will be housemaster

164. of the disposition

Rationale for choice of *oikodespotēs*:

The chart is nocturnal. The Sun is cadent and the Moon is in the west. The Moon might be the predominator, as it is angular (it is in the bounds of Mercury and its house-lord is Venus). But if we discount the Moon because it is in the west and descending, we go to the Ascendant in Scorpio. Its house-lord is Mars, and its bound-lord at 18° Scorpio, again is Mercury. Thus either way the *oikodespotēs* is Mercury. Titus Pitenius suggests its having made an appearance seven days before also affects its choice for

4. No. 137 (a, b, c) in GH

Louvre N 2342 (a), P. Lond. 110 (b),

Louvre 2342 bis (c)

Dated to 4 December 137

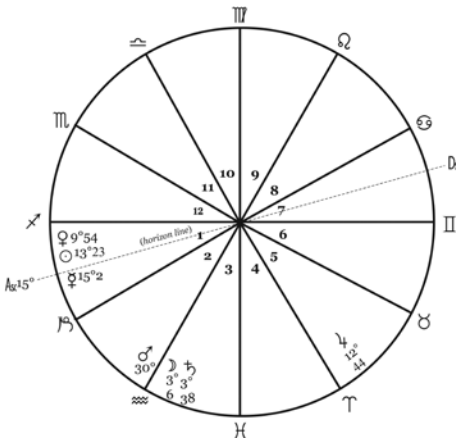

Text and Translation

Col. I (selected lines)

(from Louvre N 2343 [a])

6. ἡλιος ἐν τοξοτηρι μοιρων ἰγ̄ λεπτοκγ̄

7. οικω διος οριοις αφρ[οδε]ιτηγ̄

8. σεληνης υδροχω μ[οιρων] γ̄ λεπτοζ̄

9. ανατολικος [οικω κρονου] οριοις ερμου

20. αφροδειτης ἐν τοξοτη μοι[ρ]ων θ̄

21. λεπτον νδ̄ εωα ανατολας

41. ο οικοδεσποτης της γενεσεως αυτου

42. ο της αφροδειτης αστηρ

6. Sun in Sagittarius 13 degrees 23 minutes

7. in the house of Zeus, bounds of Aphrodite

8. Moon in Aquarius 3 degrees 6 minutes

9. rising up, [in the house of Kronos] bounds of Hermes

20. Aphrodite in Sagittarius 9 degrees 54 minutes

21. in a phase of visibility in the morning

41. The housemaster of the nativity itself

42. the star of Aphrodite

Rationale for choice of *oikodespotēs*:

The chart is diurnal. The Sun is in the first place, rising in the east; it is the predominant. It is in the bounds of Venus, which is also in the first place with the Sun. In fact, Venus is combust, but the text states that it is in a phase of visibility ahead of the Sun (it will become visible ahead of the Sun during the next month). Again the condition of visibility (which is mentioned by Porphyry in his instructions) seems to be important.

5. No. 138/161 in *GH*

P. Princeton 75

Dated to 2nd century CE

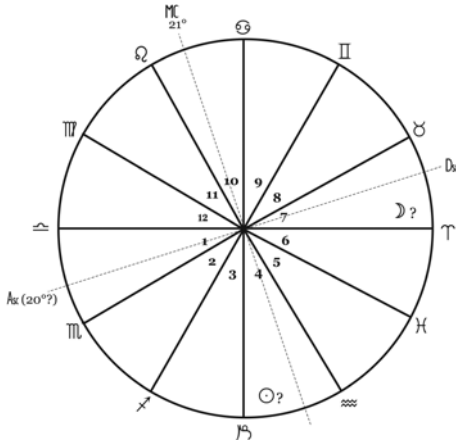

Text and Translation

(beginning in the middle of line 10)

10. τῆ ἀπας περὶ τοῦ οἰκοδεσπο
 11. [του των] ἀστερων ψηφογ
 ἐπικρατούντας παντων δε
 12. [.] καὶ ἀστερων τον του ερμου
 ἀστερα ἐσχηκοτα
 13. [.] . . . η . [. . .] ορχο[.] το της
 οἰκοδεσποτειας βραβειον ἐσχατα
 14. [.] δεδει μηνας ιζ̄ μεθ ους παρηλθε
 τον κινωτικον
 15. [κλιμακτ]ηρικον ορον και γεινεται η
 υποστασις απο του οικοδε
 16. [σποτου] δι[ευτυχ]ει

10. Then the whole [.] concerning
 the housemaster
 11. [of those of the] stars all
 predominating in the count
 12. [.] the stars; the star of Hermes
 having held
 13. [.] . . . [. . .] the prize of the house-
 mastership at last
 14. [.] Beware [for] 17? months after
 which the injurious
 15. crisis term has passed and the
 support from the house-
 16. master comes to be. Good luck!

Rationale for choice of *oikodespotēs*:

Unfortunately all of the planetary positions are missing; we know only that it is a nocturnal chart and the positions of four lots, from which the Ascendant may be reconstructed. The passage on the *oikodespotēs* is also filled with lacunae; Mercury may be the *oikodespotēs*, and the text possibly says it may become a support for the native after a crisis time has passed. But we do not know the position of Mercury in this chart (only that it would have to be close to the Sun, and therefore probably in Sagittarius or Capricorn). The juxtaposition of ‘support’ (*hupostasis*) and *oikodespotēs* here brings to mind a passage from Rhetorius (in *CCAG* VIII/4, 207.20–21, probably citing Valens, IX, 2.14 [Pingree, 320.15–19]) which claims that when a support is well-placed, it makes the natives able to lead, royal, and fit for command. Could ‘support’ be another way of describing the *oikodespotēs*?

6. No. 4278 in APO

No. 4278.7, 9; vol. 1, pp. 286–87; vol. 2, pp. 426–27

Dated to late 4th/early 5th century CE by Alexander Jones

This chart is too fragmentary to create a wheel with positions. No planetary positions can be identified; there remain only some degrees and minutes without attribution. However, in the text that survives, *οικοδεσπό* and *ζυνοικοδεσποτη* are mentioned, as well as some references to times of life.

Text and translation:

[lines 1–5 contain degree and minute listings] (Jones’s translation, modified)

7.]ϣυο οἰκοδεσπό[τασ	7. housemaster
8.]. χρόνον διαιρε. [8. time divide?
9.] ζυνοικοδεσποτη[9. co-housemaster
10.]. τὴν ἡλικίαν β[10. the time of l[ife?]
11.]. μὲν τὸ κακῶς θα[11. bad death?
12.]. ους. αὐτὸν δὲ το[12. the very
13.]. δ..εξ.[13. . . .
14.] ὁμοίως μη..[14. likewise . . .

The references to times of life and manner of death are, Jones remarks (vol. 1, 287), ‘unparalleled among documentary horoscopes.’ He suggests it may be an instructional rather than a personal chart. Since there are other ‘documentary’ (i.e. original) charts which mention an *oikodespotēs*, always given after the planetary positions, I do not find it so unusual that this chart could only be instructional and not actually be the chart of an astrological client. Furthermore, nos 95 and 138/161 in *GH* may contain delineation on times of life. It is also extremely interesting to see the *sunioikodespotēs* mentioned, since this co-ruler is discussed by Antiochus, Porphyry and Hephaestio.

Literary Charts

The next three charts all come from Antigonus of Nicaea (ap. Hephaestio, II, 18).¹

7. No. L40 in *GH*

Possibly the chart of a member
of Hadrian's family (*GH*, 80)

Dated to 5 April 40 CE

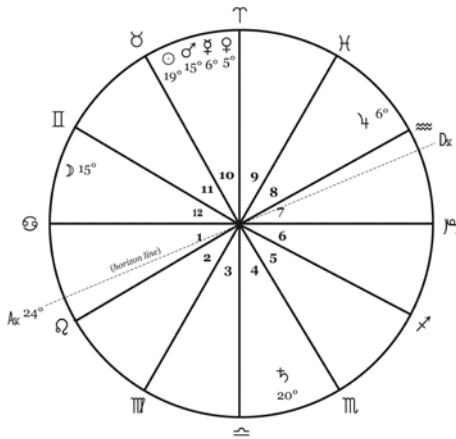

Text and Translation

(Hephaestio, II, 18.54, Pingree, I, 163.2–11)

ἔστω τινα ἔχειν τὸν ἥλιον ἐν Κριῶ περι
μοίρας ιθ ὀρίοις Ἑρμοῦ, Σελήνην ἐν Διδύμοις
μοίρα ιε' ὀρίοις Ἀφροδίτης,
Κρόνον Ζυγῶ περι μοίρας κ ἀκρόνυχον, Δία
Ἰδραχῶ μοίρα ς' ὀρίοις Ἑρμοῦ ἐπ'
ἀνατολῆς ἐώας, Ἄρην δὲ ἐν Κριῶ περι μοίρας
ιε ὀρίοις Ἑρμοῦ, Ἀφροδίτην ὁμοίως
Κριῶ περι μοίρας ε ὀρίοις Διός, Ἑρμῆν δὲ ἐν
Κριῶ περι μοίρας ς ὀρίοις Διός, τῶν τριῶν ἔτι
ὑπὸ δύσιν ὄντων, ὁ δὲ ὠροσκοπὸς Καρκίνῳ
μοίρα κδ' οἰκοδεσποτῆσει τῆς
<γενέσεως>, φησὶν, ὁ Ἄρης.

Let someone have the Sun in Aries at
around 19 degrees in the bounds of
Hermes; the Moon in Gemini at the 15th
degree in the bounds of Aphrodite;
Kronos in Libra around 20 degrees,
acronycal; Zeus in Aquarius in the 6th
degree in the bounds of Hermes in a
phase of visibility ahead of the Sun;
Ares in Aries around 15 degrees in the
bounds of Hermes; Aphrodite likewise
in Aries around 5 degrees in the bounds
of Zeus; Hermes in Aries around 6
degrees in the bounds of Zeus; the three
[i.e. Ares, Aphrodite and Hermes] still
in a phase of invisibility; the Hour-
marker in Cancer in the 24th degree;
Ares, he says, will be house-master
of the <nativity>.

1 For a discussion of these charts in historical context, see S. Heilen, 'The Emperor Hadrian in the Horoscopes of Antigonus of Nicaea', in *Horoscopes and Public Spheres: Essays on the History of Astrology*, ed. Günther Oestmann, H. Darrel Rutkin, and Kocku von Stuckrad, *Religion and Society*, vol. 42 (Berlin/New York: De Gruyter, 2005). Also see Heilen, *Hadriani genitura*, in press, for additional commentary.

Rationale for choice of *oikodespotēs*:²

The chart is diurnal, and the Sun is in the Midheaven; it should therefore be the predominator. Its bound-lord is Mercury, so according to some doctrines it should be the *oikodespotēs*, not Mars. The house-lord of the Sun's sign, Aries, is Mars. Porphyry states that some use the house-lord of the predominator as the *oikodespotēs*, and that appears to be the case here, and with all of the charts attributed to Antigonos. (Note also that Mars receives the Sun, Venus and Mercury, as the house-lord of Aries; and is the bound-lord of Venus and Mercury. This gives it relationships with all these planets, and especially the Sun as the sect luminary.)

8. No. L76 in *GH*

Chart of the Emperor Hadrian

Dated to 24 January 76 CE

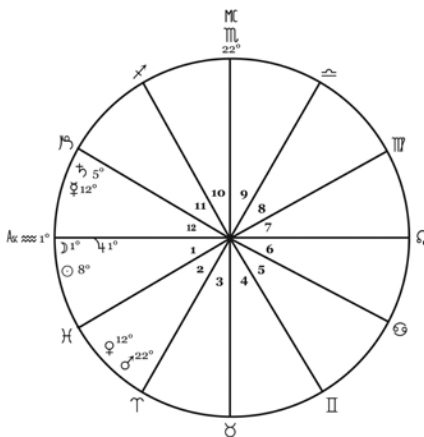

Text(s)

(Hephaestio, II, 18.22, Pingree, I, 157.28–158.7):

ἐγένετο, φησίν, τις ἔχων τὸν μὲν Ἥλιον Ὑδροχόου μοίρα ἠ', τὴν δὲ Σελήνην καὶ τὸν Δία καὶ τὸν ὠροσκοπὸν τοὺς γ ἐπὶ τῆς πρώτης μοίρας τοῦ αὐτοῦ ζωδίου Ὑδροχόου, τὸν δὲ Κρόνον Αἰγοκέρωτος μοίρα ι', τὸν δὲ Ἑρμῆν μετ' αὐτοῦ μοίρα ιβ', τὴν δὲ Ἀφροδίτην Ἰχθύων μοίρα ιβ', τὸν δὲ Ἄρεα μετ' αὐτῆς μοίρα κβ', τὸ δὲ μεσουράνημα Σκορπίου μοίρα κβ'.

(CCAG VI, 68.4–7):

—'Ἐν τῷδε τῷ διαθέματι ὁ οἰκοδεσπότης τῆς Σελήνης Κρόνος ἐν ἰδίῳ οἴκῳ τυχῶν διδωσιν τὰ τέλεια αὐτοῦ ἔτη ζωῆς νς'. ἐπειδὴ καὶ ἡ Ἀφροδίτη αὐτῷ μαρτυρεῖ, δίδωσι καὶ ἕτερα ἔτη ἠ', ὡς εἶναι τὰ ὅλα ἔτη ξδ'.

(Hephaestio, II.18.25–26, Pingree, 158.14–23):

Διὰ τί δὲ ἐν τούτοις ἐγένετο ἐπεξεργάζεται οὕτως. γέγονε δὴ αὐτοκράτωρ οὗτος διὰ τὰ δύο φῶτα τὰ ὄντα ἐπὶ τῆς ὥρας καὶ μάλιστα διὰ τὴν οὖσαν Σελήνην τῆς αἰρέσεως καὶ συνάπτουσαν μοιρικῶς τῇ τε ὥρᾳ καὶ τῷ Διὶ μέλλοντι καὶ αὐτῷ ἑῶνα φάσιν ποιήσασθαι μεθ' ἑπτὰ ἡμέρας, καὶ αὐτῶν τῶν δορυφορούντων αὐτῶν ἀστέρων οἰκείως εὐρεθέντων, τῆς μὲν Ἀφροδίτης ἐν ἰδίῳ ὑψώματι ὑπαρχούσης, τοῦ δὲ Ἄρεως ἐν ἰδίῳ τριγῶν καὶ ἐν ἰδίαις μοίραις τὴν στάσιν ἔχοντος, ἀμφοτέρων ἰδιοπούντων καὶ ἐπαναφερομένων τῇ Σελήνῃ.

2 For the references to phases in relation to the sun in the text, see S. Denningmann, 'The Ambiguous Terms ἑῶνα and ἑσπερία ἀνατολή, and ἑῶνα and ἑσπερία δύσις', *Culture and Cosmos* 11.1 and 2, no. 1 and 2 (2007): 189–210, esp. 204–08 which discuss this chart. See also her longer explanation of these terms in Denningmann, *Doryphorie*, Appendix 1, 386–474.

Translation:

Someone, he says, was born having the Sun in the 8th degree of Aquarius, the Moon, Zeus and the Hour-marker, all three on the first degree of the same zodiac sign, Aquarius; the [star] of Kronos in the 10th degree of Capricorn; the [star] of Hermes with him in the 12th degree; the [star] of Aphrodite in the 12th degree of Pisces; the [star] of Ares with her in the 22nd degree; the Midheaven in the 22nd degree of Scorpio. [Then a brief biography is given, 158.7–13.]

— In this disposition, the house-master of the Moon, Kronos, since he happened to be in his own house, gives his complete years of life, 56; since Aphrodite also witnesses him, she also gives another 8 years, so the total years are 64. — Why these things happened to him is worked out in this manner: He became emperor because the two luminaries were on the hour-marking [place], and especially because the Moon was in sect and conjoining both the Hour-marker and Zeus by degree, [Zeus] which is also about to make its phase of visibility ahead of the Sun after seven days; and also their spear-bearers [i.e. the Moon's and Sun's] were themselves found in their own affiliations, namely Aphrodite being in her own exaltation, Ares in his own triplicity and having his position in his own degrees [i.e. bounds], both of them on their own places³ and post-ascending to the Moon.

Rationale for choice of *oikodespotēs*:

Antigonus treats this chart as nocturnal.⁴ The importance of the Moon (the nocturnal sect ruler) in the consideration of lifespan is evident; she seems to be the predominator, and her house-lord, Kronos, the *oikodespotēs*. The Moon is also said to be ‘in sect’;⁵ which reinforces the treatment of the chart as nocturnal; and her spear-bearers are discussed first. Note again that Antigonus is using the *house*-lord of the luminary/predominator as the *oikodespotēs*, not the bound-lord. It is Saturn which gives its complete years (though actually the usual amount of years for Saturn in Capricorn is 57, not 56) for length of life. Again, as Mars does in L40, Saturn has relationships with a number of planets in the chart; it receives Sun, Moon, Mercury, Jupiter and the Ascendant as the house-lord of Capricorn and Aquarius.

3 Here meaning dignities: Aphrodite by exaltation and Ares by triplicity.

4 In the study I did of extant charts containing the Lots of Fortune and Daimon—see my article, ‘The Lots of Fortune and Daemon in Extant Charts from Antiquity (First Century BCE to Seventh Century CE)’, *MHNH*, 8 (2008): 173–90—with very few exceptions, charts which have the Sun in the first place are treated as diurnal. Obviously the degree of the sun is being considered here, whereas most other examples do not give degrees.

5 Neugebauer and Van Hoesen, *GH*, 90 and n. 10, have mistranslated ‘τῆς αἰρέσεως’ as ‘of the (same) sect’ and said in the note that ‘meaning not clear’. But if the chart is nocturnal, naturally the Moon is in sect.

9. No. LI3, IV in GH

Chart of Pedanius Fuscus?

Dated to 6 April 113 CE

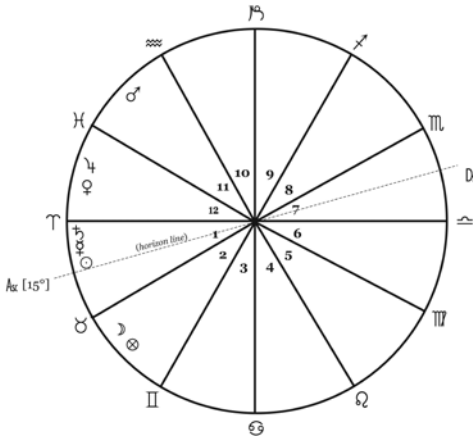

Text and Translation

(Hephaestio, II, 18.63–64, Pingree, I, 165.1–9):

τὸν μὲν Ἥλιον καὶ τὸν ὠροσκοπὸν εἶχε Κριῶ, Σελήνην Ταύρω, Κρόνον Κριῶ μετὰ ἡμέρας τρεῖς ἐπὶ ἑώας ἀνατολῆς τὴν φάσιν ποιούμενον, Ἑρμῆν ὁμοίως ἐν Κριῶ ἐπὶ ἑώας δύσεως, Δία ἐν Ἰχθύσι ἐπὶ ἑώας ἀνατολῆς, Ἀφροδίτην ἐν Ἰχθύσι ἐπὶ στηριγμοῦ ἑώου, Ἄρεα Ὑδροχόω ἐπὶ ἀνατολῆς ἑώας, ὁ κλήρος τῆς τύχης εἰς Ταύρον πίπτει: οἰκοδεσποτήσῃ, φησίν, ὁ τοῦ Ἄρεως ἀστὴρ τῆς γενέσεως. ἡ τρίταια τῆς Σελήνης Διδύμοις, ἡ ἑβδομαία ἐν Λέοντι, ἡ τεσσαρακοσταία ἐν Ζυγῶ.

He had the Sun and the Hour-marker in Aries, Moon in Taurus, Kronos in Aries, making after three days his appearance at morning rising, Hermes likewise in Aries in a phase of invisibility with the Sun, Zeus in Pisces in a phase of visibility ahead of the Sun, Aphrodite in Pisces in a station ahead of the Sun, Ares in Aquarius in a phase of visibility ahead of the Sun, the Lot of Fortune falls in Taurus; the star of Ares, he says, will be the house-master of the nativity. The third [day] of the Moon is in Gemini, the seventh in Leo, the fortieth in Libra.

Rationale for choice of *oikodespotēs*:

Here, again with the Sun in the first place, the chart seems to be treated as diurnal. The sun is in a good place, and rising (and in its sign of exaltation). So it will be the predominant, and Antigonus again takes its *house*-lord, Mars, as the *oikodespotēs*. Mars is in a good place (the eleventh), and in a phase of visibility (both, incidentally, considered important by Porphyry for a planet to be the lord of the nativity). Mars in Aquarius is used to show his death by the hand of a man (because Aquarius is a human sign) and at age 25, because the rising time of Aquarius is 25°. ('And his being harmed by a man is because Ares is in a human-shaped zodiac sign. . . . He was fond of fighting because of Ares being on the post-ascension of the Midheaven and Hermes being in the house of Ares, and he said that he died badly around the age of 25 because the ascension (that of Taurus and Aquarius, I think) was the same.' . . . τὸ δὲ καὶ ἐξ ἀνθρώπου εἶναι τὴν βλάβην διὰ τὸ τὸν Ἄρεα εἶναι ἐν ἀνθρωποειδεῖ ζῳδίῳ. . . . φιλομόναχος δὲ διὰ τὸν τοῦ Ἄρεως ὄντα ἐπὶ τῆς ἐπαναφορᾶς τοῦ μεσουρανήματος καὶ τὸν Ἑρμῆν ὄντα ἐν οἴκῳ τοῦ Ἄρεως, τὸ δὲ περὶ κε')

ἔτος τεθνάναι αὐτὸν κακῶς εἶπε διὰ τὴν ἀναφορὰν (οἶμαι τοῦ Ταύρου καὶ τοῦ Ὑδροχόου) τὴν αὐτὴν οὖσαν. [165.24–31].) Here Mars is used not only for lifespan predictions, but for character as well.

10. No. L482 in GH

Chart of one ‘unnourished’

Dated to 21 March 482

(in Rhetorius, *CCAG VIII/1*)⁶

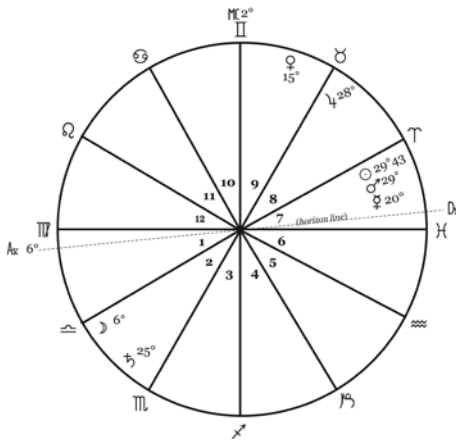

Text

CCAG VIII/1, 240.8–28:

Τοὺς οἰκοδέκτορας καὶ ὀριοκράτορας τῶν φώτων καὶ τοῦ ὠροσκόπου δεῖ λαμβάνειν οἰκοδεσπότης, ἐπὰν δὲ οὗτοι ὑπαυγοὶ τύχῳσιν ἢ ἀποκεκλιότες ἢ μετὰ ζῳδίου ἡμέρας φάσιν δυτικὴν ποιούμενοι, ἀνοικοδεσπότητος ἔσται ἡ γένεσις, εἰ δὲ ἀποκλίνει τὰ φῶτα, ὁ ὀριοκράτωρ τοῦ ὠροσκόπου ἔσται οἰκοδεσπότης, εἰ δὲ καὶ οὗτος παραπέσῃ ἢ ὑπαυγος ἢ, πάλιν ἀνοικοδεσπότητος ἔσται ἡ γένεσις, πολλάκις δὲ καὶ τοῦ ὀριοκράτορος ἢ οἰκοδέκτορος τοῦ αἰρετικῆς φωτὸς καλῶς κειμένου ἕτερος ἀστὴρ οἰκοδεσποτήσῃ, ὅς ἂν εὐρεθῇ πλείονα λόγον ἔχων πρὸς τὴν γένεσιν καὶ καλῶς κείμενος φάσει καὶ θέσει καὶ σχήματι, οἷον Ἡλίου Ἰχθύων κ' μγ' 7 ὀρίοις Κρόνου, Σελήνη Ζυγοῦ ζ' ὀρίοις Κρόνου, Κρόνος Ζυγοῦ κε' ὀρίοις Ἀφροδίτης, Ζεὺς Ταύρου κη' ὀρίοις Κρόνου, Ἄρης Ἰχθύων κθ' ὀρίοις Κρόνου, Ἀφροδίτη Ταύρου ιε' ὀρίοις Διός, Ἑρμῆς Ἰχθύων κ' ὀρίοις Ἄρεως, ὠροσκόπος Παρθένου ς' ὀρίοις Ἑρμοῦ, μεσουράνημα Διδύμων β' ὀρίοις Ἑρμοῦ, κλήρος Τύχης Ἰχθύων β' ὀρίοις Ἀφροδίτης.⁹—Εὐρίσκομεν τὸν μὲν Κρόνον ὑποδεξάμενον ὀρίοις μόνον Ἡλίον, Σελήνην δὲ καὶ ὀρίοις καὶ τριγῶν καὶ <ὑψώματι τὴν δὲ Ἀφροδίτην ὑποδεξάμενην ὀρίοις μόνον Κρόνον, τριγῶν δὲ καὶ> ὑψώματι Ἡλίον Ἄρη Ἑρμῆν, τριγῶν δὲ τὸν ὠροσκόπον. ἔσονται οὖν Κρόνος καὶ Ἀφροδίτη οἰκοδεσπότης, τουτέστιν ὁ μὲν Κρόνος οἰκοδεσποτῶν, ἡ δὲ Ἀφροδίτη συνοικοδεσποτοῦσα, καὶ οἱ δύο τῷ αὐτῷ χρόνῳ κατὰ τὴν ὠριμαίαν ἕκαστος τὸν θάνατον ἀπετέλεσε.

⁶ This section, from Par. gr. 2506, fol. 21v, is called ‘Epitome IV’ by Pingree in D. Pingree, ‘Antiochus and Rhetorius’, *CPh* 72 (1977): 203–23, here 217–18, 223. Pingree considers it to be genuine Rhetorius (223).

Translation:

One must take the house-stewards and bound-rulers of the luminaries and the Hour-marker as house-masters, but when these happen to be under the beams or have declined, or [are] making a setting phase with the zodiac sign of the day, the nativity will have no housemaster. If the luminaries are declining, the bound-ruler of the Hour-marker will be the housemaster. But if this one falls astray or is under the beams, again the nativity will have no housemaster. And often even when the bound-ruler or house-steward of the luminary in sect is well-placed, a different star will be the housemaster, which is the one found to have more relationship to the nativity, and well-placed by phase, position and figure, such as the Sun at 29° 43'7 of Pisces in the bounds of Kronos, the Moon at 6° of Libra in the bounds of Kronos, Kronos at 25° of Libra in the bounds of Aphrodite, Zeus at 28° of Taurus⁸ in the bounds of Kronos, Ares at 29° of Pisces in the bounds of Kronos, Aphrodite at 15° of Taurus in the bounds of Zeus, Hermes at 20° of Pisces in the bounds of Ares, the Hour-marker at 6° of Virgo in the bounds of Hermes, the Midheaven at 2° of Gemini in the bounds of Hermes, the Lot of Fortune at 12° of Pisces in the bounds of Aphrodite.⁹—We find Kronos on the one hand receiving only the Sun by bounds, but the Moon by bounds, triplicity¹⁰ and <exaltation; and Aphrodite on the other hand receiving only Saturn by bounds, but the Sun, Ares and Hermes by triplicity and> exaltation,¹¹ and the Hour-marker by triplicity.¹² And so Kronos and Aphrodite will be the housemasters: that is, Kronos is the housemaster, but Aphrodite is the co-housemistress, and the two at the same time, according to the doctrine of *horimaia*,¹³ each brought about the death.

7 The *CCAG* text has 20;43 but Neugebauer and Van Hoesen, *GH*, say on 146, n. 2 that the photo of ms. P (2506) shows clearly 29;43 (in the scan I saw, this was cut off by the binding).

8 Again, ms. P (Par. gr. 2506) shows a glyph for ♃, not ♂, and Neugebauer and Van Hoesen, 146, n. 4 say that ‘computation and “terms” require Aries’.

9 Using my (and Neugebauer and Van Hoesen’s, 146, nn. 5 and 6) reading of the ms., which clearly shows ‘12’ for the degrees and the symbol for ‘Venus’ for the terms [ⲓⲉⲩⲓ].

10 Saturn rules the air triplicity by day.

11 My emendation, based on autopsy of the ms. Neugebauer and Van Hoesen have seen that there are things wrong with the passage, and suggested that Venus must be involved in receiving planets as well as Saturn (they also suggest how she receives them), but they have not made an emendation to the text, and have merely translated the text in its confused state (see p. 146 and n. 7). In fact, they have mistranslated part of the passage: ‘We find Saturn receiving, in its terms only, sun and moon’. Saturn does receive only the Sun by term (it is the bound-lord of the 30th degree of Pisces); but it receives the Moon not only by bound, but also by triplicity (it rules air in a diurnal chart) and exaltation (it is exalted in Libra). I thank Stephan Heilen for sending me a facsimile of the ms. page, and his advice in wording the emendation. I have based the emendation’s length on the length of the average line in Par. gr. 2506, fol. 21v; the content of the emendation is based on the presumed ‘jump’ of the scribe’s eye to the line below, which begins with ⲙⲡⲟⲩⲙⲁⲩⲁ, and Venus’s receptions of Saturn by bounds (Saturn at 25° Libra is in Venus’s bounds [Egyptian]); and the Sun, Mars and Mercury by triplicity and exaltation (all three are in Pisces, whose exaltation is Venus and whose triplicity by day is also Venus).

12 Venus rules the water triplicity by day, and the earth triplicity by day.

13 See Ptolemy, *Tetr.* III, 11.9.7 (Hübner, 208.618–209.625); Hephaestio II, 11.32 (Pingree, I, 122.7–14) and Ep. IV, 25.47–48 (Pingree, II, 206.17–24; Valens III, 7.13 (Pingree, 139.6–10)

Rationale for choice of *oikodespotēs*:

The chart is diurnal. The paragraph prior to this chart gives instructions for finding an *oikodespotēs*, which says one should use the bound- and house-lords of the luminaries and the Ascendant; but also the planet found to have more ‘claims’ or ‘relationships’ (*logos*) in the nativity, by which he seems to mean relationships by dignity with the planets in the nativity. (This seems to incorporate both Ptolemy’s ideas about an *oikodespotēs* and what Porphyry writes about the *kurios*.) The explanation at the end combines these two criteria, giving more weight for the primary *oikodespotēs* to the bound-lord of the luminaries (Saturn) than to Venus, which actually has more relationships to the planets in the nativity. The greater amount of Venus’s relationships, though, provides her status as *co-oikodespotēs*. Thus Saturn becomes the housemaster, and Venus the co-housemistress. (This explanatory section only makes sense with the emendation I have proposed.) These later literary charts (see also #12 in this list) show the incorporation of Ptolemy’s ideas (which will become what is known as the ‘almuten’) coupled with Porphyry’s, as a means for determining the *oikodespotēs* of the nativity.

11a, b and c. Nos L440 in GH, L486 in GH, ‘L601’ in Rhetorius (Pingree)¹⁴

All of these charts use an *oikodespotēs* only as a single ruler of a planet—in these cases, either house- or bound-lord.

a. No. L440 in GH

‘A grammarian’, ascribed to Rhetorius

Dated to 29 September 440

In this chart, *oikodespotēs* just means house-lord (meaning #1a).

Text and translation (CCAG VIII/4, 222.9–10, Rhetorius [Pingree, 166.19–20]):... διὰ τὸ διαμετρεῖσθαι τὴν Σελήνην ὑπὸ τοῦ ἰδίου οἰκοδεσπότη. ‘Because of the Moon being

and IX, 8.17 (Pingree, 328.21–24) for descriptions and/or examples of this doctrine of *hori-maia*, using hourly times of degrees by oblique ascension or descension to predict end of life.

14 I am using the manuscript prepared by Pingree, now being completed by Stephan Heilen, to be published as Rhetorius, *Compendium astrologicum secundum epitomen in cod. Paris. gr. 2425 servatam*, eds D. Pingree and S. Heilen (Berlin/New York: De Gruyter, forthcoming).

opposed by her own housemaster . . .'. (The Moon is in Taurus, opposed by Venus in Scorpio.)

(The whole chart is in *CCAG* 8/4, 221.1–224.20; Rhetorius [Pingree, 165–69])

b. No. L486 in GH

A *katarchē* when Theodorus the augustalian prefect entered Alexandria

From 'Palchus'

Dated 17 March 486

An *oikodespotēs* is mentioned only in one place, and context shows it also is just a house-lord (i.e. meaning #1a).

Text and Translation (*CCAG* 1, 100.6–7; 100.10, 101.3–4):

Σελήνη Αἰγοκέρωτος κζ' . . .

τύχη Ὑδροχόου κζ' . . .

ἀλλὰ πάλιν ζητήσας τὸν οἰκοδεσπότην τῆς τύχης καὶ τῆς Σελήνης, εὐρήσει τὸν Κρόνον ἀποκεκλιότα . . .

The Moon in 27° of Capricorn . . .

[The Lot of] Fortune in 27° of Aquarius . . .

But again seeking the housemaster of the [Lot of] Fortune and the Moon, you will find Kronos having declined. . . .

c. No. 'L601' in Rhetorius (Pingree)¹⁵

Example of the applications and separations of the Moon

Dated by Pingree to 24 February 601

It is included in Pingree's Rhetorius manuscript (from Par. gr. 2425), but is not in *GH* or the *CCAG*. There is a reference to an *oikodespotēs* which seems just to be one ruler of the Moon—in this case, the bound-lord.

Text and translation: "Ἐστω εἶναι Σελήνην Παρθένου μοίρα κδ' τὰ μὲν ὄρια τῆς Παρθένου, ἐφ' οὗ ἐστὶ ζφδίου ἢ Σελήνη . . . καὶ ζ' Ἄρεως, ἐφ' ᾧ ἐστὶν ἢ Σελήνη Ὁ μὲν Ἄρης οἰκοδεσπότης ᾧ τῶν ὀρίων τῆς Σελήνης. . . . 'Let the Moon be in the 24th degree of

15 See Pingree, 'Antiochus and Rhetorius', 212, 221; idem, ed., trans. and comm., *The Yavanajātaka of Sphujidhvaja*, 2 vols (Cambridge, MA/London: Harvard University Press, 1978), II, 439; G. Bezza, 'L'astrologia greca dopo Tolomeo: Retorio', in *Homo Mathematicus: Actas del Congreso Internacional sobre Astrólogos Griegos y Romanos (Benalmádena, 8–10 Octubre de 2001)*, ed. Aurelio Pérez Jiménez and Raúl Caballero (Málaga: Charta Antiqua, 2002), 183–84, 187; a Latin version in Hugo of Santalla, *The Liber Aristotilis of Hugo of Santalla*, ed. Charles Burnett and David Pingree (London: The Warburg Institute, 1997), 8, 27–28, 134–35. (Thanks to Stephan Heilen for the latter two references.)

Virgo the bounds of Virgo, in whose zodiac sign the Moon is . . . and 7 of Ares (in which the Moon is) Ares, being the housemaster of the bounds of the Moon

12. No. L487 in GH

Katarchē of distressing letters;
from 'Palchus'

Dated 5 September 487

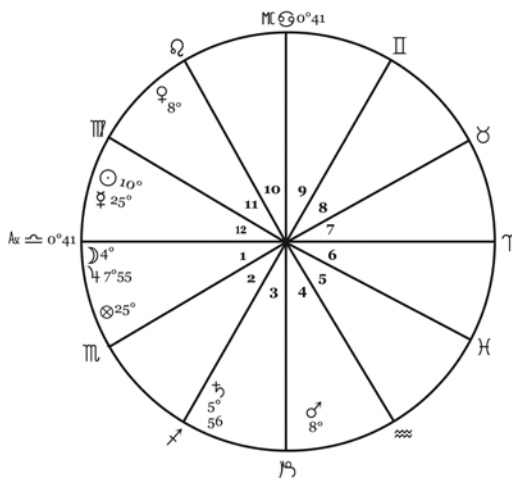

Text

CCAG VI, 63.4-64.5; 64.8-10, 15-18
CCAG I, 106.10-11, 12 (*italics*)

Ἡλιος ἐν Παρθένῳ μοίραις ι', Σελήνη
Ζυγῷ μοίραις δ', Κρόνος ἐν Τοξότη
μοίραις ε' νς', Ζεὺς ἐν Ζυγῷ μοίραις
ζ' νε', Ἄρης Αἰγοκέρωτι η', Ἀφροδίτη
ἐν Λέοντι η', Ἑρμῆς ἐν Παρθένῳ κε',
ὠροσκόπος Ζυγῷ ο' μα', μεσουράνημα
Καρκίνῳ ο' μα', κλήρος Τύχης Ζυγῷ
κε', ὁ ἀναβαίνων ἐν Σκορπίῳ β' κδ'. καὶ
εὖρομεν τὸν Δία μοιρικῶς ὠρονομοῦντα
καὶ τὴν Ἀφροδίτην κυρίαν τουτέστιν
τοῦ ὠροσκόπου, τῆς Σελήνης καὶ
τοῦ Διὸς καὶ τοῦ κλήρου τῆς τύχης
ἀγαθοδαιμονοῦσαν καὶ ἑῶαν ἀνατολικὴν
καὶ τοῖς ἀριθμοῖς προστεθέντας καὶ
δεκατεύουσαν τὴν τριταίαν Σελήνην
καὶ τὸ δωδεκατημόριον αὐτῆς Σκορπίῳ
τετυχηκός...

σκοπήσας γὰρ μετὰ ταῦτα ἀκριβῶς τὴν
καταρχὴν εὖρον τὴν μὲν Ἀφροδίτην
τὴν οἰκοδεσπότην τῆς καταρχῆς μηδὲνα
λόγον ἔχουσαν εἰς τὸν ὠροσκόπον ...
ἀναγκαῖον οὖν ἔστιν ἐπὶ πάσης (15)
καταρχῆς ζητεῖν καὶ τὰς μεσεμβολὰς
Ἡλίου καὶ τῶν ἀστέρων καὶ τὰς
ἐμπεριοχὰς τοῦ ὠροσκόπου καὶ τῆς
Σελήνης καὶ τοῦ ἀστέρος τοῦ λόγον
ἔχοντος εἰς τὴν οἰκοδεσποτίαν τῆς
καταρχῆς:

Translation:

Sun in Virgo, 10 degrees, Moon in Libra, 4 degrees; Kronos in Sagittarius, 5 degrees 56 [minutes]; Zeus in Libra, 7 degrees 55 [minutes]; Ares in Capricorn 8; Aphrodite in Leo 8; Hermes in Virgo 25; Hour-marker in Libra 0 [degrees] 41 [minutes]; Mid-heaven in Cancer 0 [degrees] 41 [minutes], Lot of Fortune in Libra 25, the North Node in Scorpio 2 [degrees] 24 [minutes]. And we find Zeus marking the hour by degree¹⁶ and Aphrodite

16 This is not true (Jupiter is about 6 degrees from the Ascendant), as Neugebauer and Van Hoesen also point out (149, n. 6).

the lady, i.e. of the Hour-marker, the Moon, Zeus and the Lot of Fortune¹⁷ in the good daimon place and in a phase of visibility ahead of the Sun and direct in motion [*lit. additive in numbers*] and in a tenth-place position with the Moon on the third day, and its *dodekatēmorion* happened to be in Scorpio. . . . For afterwards, when I examined the *katarchē* accurately I found that Aphrodite, the house-mistress of the *katarchē*, had no claim in the Hour-marker;¹⁸ . . . So it is necessary for every *katarchē* to seek out the interventions of the Sun and the stars, and the enclosures of the Hour-marker and the Moon and the star having a claim in the house-mastership of the *katarchē*.

Rationale for choice of *oikodespotēs*:

Again, in this late chart, greater weight is given to a planet with more ‘claims’ or ‘relationships’ to the other planets in the chart. In this case, it is Venus, who is the house-lord of the Ascendant, the Moon, Zeus and the Lot of Fortune; even though she is not the almuten of the Ascendant (it is Saturn), she is positioned far better than Saturn, since she is in the eleventh, a good place and, as the text tells us, she is in a phase of visibility ahead of the sun, direct in motion and will be in a tenth-place position to the Moon in three days (when the Moon goes into Scorpio, where Venus’s *dodekatēmorion* also is). However, the interpretation of this chart was faulty; the astrologer did not take into account certain deficiencies of Venus, and the fact that Saturn has the stronger claim in the Ascendant (other things not relevant to the *oikodespotēs* also come into play here).

-
- 17 Using the genitives for Moon, Zeus and the Lot of Fortune, as in CCAG I, 106.9–11: και τὴν Ἀφροδίτην [κατὰ = κυρίαν] τοῦ ὥροσκόπου καὶ τῆς Σελήνης καὶ τοῦ Διὸς καὶ τοῦ κλήρου τῆς τύχης ἀγαθοδαιμονοῦσαν καὶ ἐψὲν ἀνατολικήν. . . .
- 18 Again, not exactly true, because Venus is the house-lord of Libra. But Saturn *will* win the overall mastership of the Ascendant because he is exaltation ruler, triplicity ruler and bound ruler. (This is akin to Ptolemy’s procedure for an *oikodespotēs*.)

Appendix 7.B: A Comparison of Antiochus, *Introduction*, Chapter 28 and Porphyry, *Introduction*, Chapter 30

Note: similarities in the texts are underlined

Antiochus, *Introduction*, Chapter 28 (29 Cumont):

CCAG VIII/3, 118.9–22:

κθ'. Λέγει δὲ ὡς οἰκοδεσπότης γενέσεως καὶ κύριος καὶ ἐπικρατήτωρ διαφέρουσιν ἀλλήλων. ἐπικρατήτορα μὲν γὰρ λέγει τῶν δύο φωστήρων (10) ὅς μᾶλλον τῷ γενετήρι διαθέματος ἐπικρατεῖ, καὶ τινας μὲν λέγειν ὡς ἡμέρας ὁ "Ἥλιος ἐπικρατεῖ, νυκτὸς δὲ ἡ Σελήνη. τὸ δὲ ἀκριβὲς ἐπὶ μὲν ἡμερινῆς γενέσεως ἐν τῷ ἀπηλιώτῃ τυγχάνοντος τοῦ Ἥλιου αὐτὸς καὶ τὴν ἐπικράτησιν ἔχει διὰ τὸ τῆς ἡμέρας ἄρχειν, ἀποκλίναντος δὲ αὐτοῦ ἡμέρας ἐπὶ λίβρα, ἐὰν ἡ Σελήνη ἐν τῷ ἀπηλιώτῃ ᾖ, αὐτὴ ἐπικρατήσῃ· (15) ὁμοίως δὲ καὶ ἐν τῇ ἐπαναφορᾷ τοῦ ὠροσκόπου αὕτη τύχη, τοῦ Ἥλιου ἀποκλίναντος ἐκ τοῦ ἀπηλιώτου, αὐτὴ τὴν ἐπικράτησιν ἔξει· ἀμφοτέρων δὲ αὐτῶν ἀποκεκλικότων ἐπὶ λίβρα, ὁ ὠροσκόπος λήψεται τὴν ἐπικράτησιν. ἐπὶ δὲ νυκτερινῆς γενέσεως ἐὰν ἡ Σελήνη ἐν τῷ ἀπηλιώτῃ ἀναφέρηται, αὐτὴν λήψεται καὶ τὸ κράτος· ἐὰν δὲ εἰς λίβρα (20) ἀποκλίνῃ ὁ "Ἥλιος <καὶ> ἔτι ὑπόγειος ὢν ἐπαναφέρηται τῷ ὠροσκόπῳ, αὐτὸς ἐπικρατήσῃ· ἐὰν δὲ ἀμφω ὑπόγειοι [here the text breaks off, ending Book 1]

Porphyry, *Introduction to the Tetrabiblos*, Chapter 30:

CCAG V/4, 206.1–207.1:

(206.) Περὶ οἰκοδεσπότης καὶ κυρίου καὶ (1τ)
ἐπικρατήτορος. (2τ)
"Ἐτι τίνι διαφέρουσιν ἀλλήλων οἰκοδεσπότης γενέσεως καὶ (3)
κύριος καὶ ἐπικρατήτωρ, χρὴ διεσταλκέναι. οἱ γὰρ ἀρχαῖοι
πλέξαντες τὰς ὀνομασίας τὴν ἐπαγγελίαν οὐ διεκρίναν. ἰδίαν (5)
γὰρ ἕκαστος ἔχει δύναμιν, ὥσπερ ναύκληρος καὶ κυβερνήτης·
διδάξομεν οὖν, τίνι ἀλλήλων διαφέρουσι. τινὲς μὲν οὖν ἡμέρας τὸν
"Ἥλιον, νυκτὸς δὲ τὴν Σελήνην ἐπικρατεῖν τίθενται, τὸ δὲ ἀκριβὲς

διατεθήσεται οὕτως· ἐπὶ μὲν ἡμερινῆς γενέσεως ὁ Ἥλιος ἐὰν ἐν τῷ ἀπηλιώτῃ ἀναφέρηται, αὐτὸς λήψεται τὴν ἐπικράτησιν· (10) ἀποκλίναντος δὲ τοῦ Ἥλιου ἐπὶ λίβα, ἐὰν ἡ Σελήνη τύχη ἐν τῷ ἀπηλιώτῃ, ἐκείνη λήψεται, καὶ ἀναφέρηται τῷ ὠροσκόπῳ διὰ τὸ ἐπὶ τὸν ἀπηλιώτην ἀναβαίνειν· ἀμφοτέρων δὲ ἀποκεκλικῶτων ἐπὶ τὸν λίβα ὁ ὠροσκόπος ἔξει τὴν ἐπικράτησιν. ἐπὶ δὲ νυκτερινῆς γενέσεως, ἐὰν μὲν ἡ Σελήνη ἐπὶ τὸν ἀπηλιώτην ἀναφέρηται, αὕτη (15) λήψεται τὴν ἐπικράτησιν· ἐὰν δὲ ἀποκλίνη ἐπὶ λίβα, ὁ δὲ Ἥλιος ἔτι ὑπόγειος ὢν ἀναφέρηται τῷ ὠροσκόπῳ, ἐκεῖνος ἐπικρατήσῃ. ἐὰν δὲ ἀμφοτέροι ὑπόγειοι τύχωσιν ἐπικέντρων μὲν ὄντων αὐτῶν ἢ ἐπαναφερομένων, ἡ Σελήνη ἔξει τὴν ἐπικράτησιν διὰ τὴν αἴρεσιν· ἐὰν δὲ ἡ μὲν ἀποκεκλικυῖα εὐρίσκηται, ὁ δὲ ἐπικέντρος ᾗ, (20) ἐκεῖνος, τὸ γὰρ ὄλον ὁ ἐπικεντρότερος τῶν φώτων καὶ ὁ μᾶλλον ἐν τῷ ἀπηλιώτῃ καὶ τῆς αἰρέσεως κρίνεται ἐπικρατήτωρ. ἐὰν δὲ ἀμφοτέροι ἀποκλίνωσιν, ἀποίσεται τὴν ἐπικράτησιν ὁ ὠροσκόπος τότε· ὅταν δὲ στήσης τὸν ἐπικρατήτορα, ἐκ τούτου ὁ οἰκοδε- (207.) σπότης ληφθήσεται καὶ ὁ συνοικοδεσπότης.

Translations

Note: similarities in the texts are italicised

Antiochus:

28 (29 Cumont). He says that *the housemaster of the nativity, the lord and the predominator are different from one another*. For he says the predominator is the one of the two luminaries which predominates over the theme's birth hour, and *some say that by day the Sun predominates, but by night the Moon. To be precise, when the Sun happens to be in the east in a diurnal geniture, he himself has the predomination* because he rules over the day, *but if he is declining by day in the west, if the Moon is in the east, she will predominate; likewise even if she happens to be in the post-ascension of the Hour-marker [i.e. the second place], while the Sun is declining from the east, she will have the predomination; but when both of them are declining in the west, the Hour-marker will take the predomination. For a nocturnal nativity, if the Moon is being carried up in the east, she herself will take the power; but if she is declining in the west, the Sun post-ascending to the Hour-marker, even if still under the earth will himself predominate; but if both are under the earth*

Porphyry:

30. On house-master, lord and predominator.

Furthermore, precise definitions are required to *differentiate house-master of the nativity, lord and predominator from one another*. For the ancients entangle the names up and do not distinguish their characteristics. For each has its own power, just like a skipper and a pilot; so we will teach how they are different from each other. Now *some* hold that *the Sun by day and the Moon by night predominate*, but it is set out *precisely* like this: *for a diurnal nativity the Sun*, if it is being carried up *in the east*, will *itself* take *the predomination*; *but when the Sun is declining on the west* [side of the chart], *if the Moon is in the east*, that one [*the Moon*] will take it, *even if she is post-ascending the Hour-marker*, because she is going up toward the east. But *if both* [the luminaries] *are declining on the west* [side], *the Hour-marker* will hold *the predomination*. *For a nocturnal nativity, if the Moon is being carried up on the east* [side], *she herself* will take *the predomination*. *But if she is declining on the west* [side of the chart], *but the Sun, though still under the earth is post-ascending the Hour-marker, that one will predominate*. *If both* [luminaries] happen to be *under the earth*, on centrepins or post-ascending, the Moon will hold the predomination because of sect. But if she is found to have declined [from a centrepin], but he [the Sun] is on a centrepin, he [will predominate]. For generally the luminary that is more on a centrepin, and more in the east and of the sect is judged to be the predominator. If both [the luminaries] are declining [from centrepins], then the Hour-marker will obtain the predomination. But when you have determined the predominator, the housemaster will be taken from this, and the co-housemaster.

Appendix 7.C: Porphyry, *Introduction to the Tetrabiblos*, Chapter 30

CCAG V/4, 206.1–208.5:

(206.) Περὶ οἰκοδεσπότηου καὶ κυρίου καὶ ἐπικρατήτορος.

Ἔτι τίνι διαφέρουσιν ἀλλήλων οἰκοδεσπότης γενέσεως καὶ κύριος καὶ ἐπικρατήτωρ, χρῆ διεσταλκέναι. οἱ γὰρ ἀρχαῖοι [5] πλέξαντες τὰς ὀνομασίας τὴν ἐπαγγελίαν οὐ διεκρίναν. ἰδίαν γὰρ ἕκαστος ἔχει δύναμιν, ὥσπερ ναύκληρος καὶ κυβερνήτης· διδάξομεν οὖν, τίνι ἀλλήλων διαφέρουσι. τινὲς μὲν οὖν ἡμέρας τὸν Ἥλιον, νυκτὸς δὲ τὴν Σελήνην ἐπικρατεῖν τίθενται, τὸ δὲ ἀκριβὲς διατεθήσεται οὕτως· ἐπὶ μὲν ἡμερινῆς γενέσεως ὁ Ἥλιος ἐάν [10] ἐν τῷ ἀπηλιώτῃ ἀναφέρηται, αὐτὸς λήψεται τὴν ἐπικράτησιν· ἀποκλίναντος δὲ τοῦ Ἥλιου ἐπὶ λίβρα, ἐάν ἡ Σελήνη τύχη ἐν τῷ ἀπηλιώτῃ, ἐκεῖνη λήψεται, κὰν ἐπαναφέρηται τῷ ὠροσκόπῳ διὰ τὸ ἐπὶ τὸν ἀπηλιώτην ἀναβαίνειν· ἀμφοτέρων δὲ ἀποκεκλικώτων ἐπὶ τὸν λίβρα ὁ ὠροσκόπος ἔξει τὴν ἐπικράτησιν. ἐπὶ δὲ νυκτερινῆς [15] γενέσεως, ἐάν μὲν ἡ Σελήνη ἐπὶ τὸν ἀπηλιώτην ἀναφέρηται, αὕτη λήψεται τὴν ἐπικράτησιν· ἐάν δὲ ἀποκλίνη ἐπὶ λίβρα, ὁ δὲ Ἥλιος ἔτι ὑπόγειος ὢν ἐπαναφέρηται τῷ ὠροσκόπῳ, ἐκεῖνος ἐπικρατήσει. ἐάν δὲ ἀμφοτέροι ὑπόγειοι τύχωσιν ἐπικέντρων μὲν ὄντων αὐτῶν ἢ ἐπαναφερομένων, ἡ Σελήνη ἔξει τὴν ἐπικράτησιν διὰ τὴν αἴρε- [20] σιν· ἐάν δὲ ἡ μὲν ἀποκεκλικυῖα εὐρίσκηται, ὁ δὲ ἐπίκεντρος ἦ, ἐκεῖνος. τὸ γὰρ ὅλον ὁ ἐπικεντρότερος τῶν φώτων καὶ ὁ μᾶλλον ἐν τῷ ἀπηλιώτῃ καὶ τῆς αἰρέσεως κρίνεται ἐπικρατήτωρ. ἐάν δὲ ἀμφοτέροι ἀποκλίνωσιν, ἀποίσεται τὴν ἐπικράτησιν ὁ ὠροσκόπος τότε· ὅταν δὲ στήσης τὸν ἐπικρατήτορα, ἐκ τούτου ὁ οἰκοδε- (207.) σπότης ληφθήσεται καὶ ὁ συνοικοδεσπότης.

30. On housemaster, lord and predominator.

Furthermore, precise definitions are required to differentiate house-master of the nativity, lord and predominator from one another. For the ancients [5] entangle the names up and do not distinguish their characteristics. For each has its own power, just like a skipper and a pilot; so we will teach how they are different from each other. Now some hold that the Sun by day and the Moon by night predominate, but it is set out precisely like this: for a diurnal nativity the Sun, if [10] it is being carried up in the

east, will itself take the predomination; but when the Sun is declining on the west [side of the chart], if the Moon happens to be in the east, that one [the Moon] will take it, even if she is post-ascending the Hour-marker, because she is going up on the east [side of the chart]. But if both [the luminaries] are declining on the west [side], the Hour-marker will hold the predomination. For a nocturnal [15] nativity, if the Moon is being carried up on the east [side], she herself will take the predomination. But if she is declining on the west [side of the chart], but the Sun, though still under the earth is post-ascending the Hour-marker, that one will predominate. If both [luminaries] happen to be under the earth, on centrepins or post-ascending, the Moon will hold the predomination because of sect. [20] But if she is found to have declined [from a centrepin], but he [the Sun] is on a centrepin, he [will predominate]. For generally the luminary that is more on a centrepin, and more in the east and of the sect is judged to be the predominator. If both [the luminaries] are declining [from centrepins], then the Hour-marker will obtain the predomination. But when you have determined the predominator, the housemaster [p. 207] will be taken from this, and the co-housemaster.

(207.) ὁ μὲν γὰρ κύριος
 τοῦ ζῳδίου, ἐν ᾧ ἔστιν ὁ ἐπικρατήτωρ, οἰκοδεσπότης ἔσται, ὁ δὲ
 τῶν ὀρίων συνοικοδεσπότης. τούτους δεῖ οὖν ἐπισκέπτεσθαι, πῶς
 κεῖνται καὶ ἐν ποίῳ σχήματι εἰσι καὶ εἰ μαρτυροῦσι τῷ ὠροσκόπῳ
 [5] ἢ τῇ Σελήνῃ· ἐκ γὰρ τούτων ἡ ὄλη διάκρισις ἔσται. τινὲς δὲ ἀπλῶς
 τὸν τῶν ὠροσκοπούντων ὀρίων κύριον οἰκοδεσπότην τίθενται
 τῆς γενέσεως καὶ συνοικοδεσπότην τὸν τοῦ ζῳδίου. κύριον δὲ
 τῆς γενέσεως οἱ μὲν τὸν τοῦ μεσουρανήματος δεσπότην ὀρίζονται,
 ἔάνπερ ἐπίκεντρος χρηματίζοι, εἰ δὲ μή, τὸν τῷ μεσουρανήματι
 [10] ἐπιπαρόντα, ὡσπερ ἐπὶ ἀκροπόλει τῆς γενέσεως ἐπιτυραννοῦντα
 τῆς πράξεως, εἰ δὲ μή, τὸν ἐπαναφερόμενον τῷ μεσουρανήματι
 οἱ δὲ πρῶτον μὲν τὸν τοῦ ὠροσκόπου κύριον ἢ τὸν ἐπιβεβηκότα
 αὐτοῦ τῷ οἴκῳ καὶ τοῖς ὀρίοις, εἶτα τὸν τῆς Σελήνης, εἶτα τὸν
 τοῦ μεσουρανήματος, εἶτα τὸν τῆς τύχης, εἶτα τὸν πρὸς ζ' ἡμερῶν
 [15] τῆς ἀποκυήσεως ἢ ἐντὸς ζ' ἡμερῶν φάσιν ἀνατολῆς ἢ δύσεως ἢ
 στηριγμοῦ ποιοῦμενον. τοῦτον γὰρ τῆς κοσμικῆς ἐπισημασίας
 τότε γινόμενον αὐθεντικὸν ὁμολογουμένως καὶ τῶν γεννωμένων
 κυριεύειν, ἔάν δὲ δύο ᾧσι, τὸν ἐπανατέλλοντα δυναμικώτερον τί-
 θενται. τούτοις προσσυλλαμβάνουσι τὸν τῆς συνόδου τῆς προηγου-
 [20] μῆνης σεληνιακῆς δεσπότην· λέγω δὴ τὸν τῶν ὀρίων κύριον, ἐν
 οἷς ἡ σύνοδος τῆς Σελήνης πρὸς Ἡλιον ἐγένετο, ἔάνπερ ἀπὸ συν-
 ὁδου φέρηται ἢ Σελήνῃ· ἔάν δὲ φθίνουσα ᾗ, τὸν τῆς πανσελήνου
 τῶν ὀρίων γενόμενον δεσπότην. ἐκ δὲ τούτων πάντων τὸν συμ-
 παθέστατα πρὸς τὴν γένεσιν κείμενον ἀποφαίνονται κύριον, τουτ-

[25] ἔστι τὸν ἐπικεντρότερον,* τὸν ἀνατολικώτερον ἢ τὸν μᾶλλον
ἐπ' οἰκειῶν τόπων καὶ τὴν πλείστην δύναμιν πρὸς τὸ σχῆμα
τῆς γενέσεως ἔχοντα τοὺς τε συμμαρτυροῦντας αὐτῶ.

* emending ἐπικείμενον πρότερον, which is nonsensical, to ἐπικεντρότερον. (Thanks to Stephan Heilen for suggesting the need for an emendation here.)

(207.)

For the lord

of the sign in which the predominator is will be the housemaster, but the co-housemaster [will be the lord] of the bounds. And so it is necessary to investigate these [planets], how they lie and in what figure they are, and if they witness the Hour-marker [5] or the Moon. For the whole determination will be from these. Some simply hold that the housemaster of the nativity is lord of the Hour-marking bounds, and the co-housemaster [is] [lord] of the sign. Some define the master of the Midheaven as lord of the nativity, if it is on a centrepin and therefore operative; but if not, the one which is present on the Midheaven, [10] on the summit of the nativity, as it were, ruling over the action; but if not, the one post-culminating to the Midheaven. But some [take] as the foremost one the lord of the Hour-marker or the one which has landed on its house and in its bounds, then that of the Moon, then that of the Midheaven, then that of Fortune, then the one making [15] a phase of emergence, setting or station 7 days before the birth or within 7 days [of the birth]. For [they think that] this one, since it becomes, by common consent, authoritative for the cosmic symptoms at that time, also rules as lord over those who are born then. But if there are two, they make the one in a phase of visibility more potent. To these they add the master of the Concurrence of the preceding [20] lunation; I mean the lord of the bounds in which the Concurrence of the Moon with the Sun came to be, if the Moon is being carried from Concurrence. But if it is waning, the lord of the bounds of the whole Moon. From all these they declare the lord to be the one placed most sympathetically in the nativity, that [25] is the one more on a centrepin, more in a phase of visibility, or more on its own places and having the most power in relation to the figure of the nativity and those co-witnessing it.

περὶ δὲ (207.27)

τοῦ εὐρεθέντος κυρίου πῶς δεῖ σκέπτεσθαι, ἐν τοῖς ἐξῆς ῥηθήσεται
(208.) καὶ ὅση ἢ ἐκ τούτου δύναμις. πολλὴ γὰρ ἢ περὶ τούτου ζήτησις
καὶ σχεδὸν ἀπάντων δυσκολωτέρα. ἐνίοτε μέντοι γίνεται τὸν αὐτὸν
εὐρεθῆναι κύριον καὶ οἰκοδεσπότην, ὅταν ὁ εὐρεθεὶς κύριος ὁ αὐ-
τὸς ἢ τοῦ ἐπικρατήτορος φωστήρος οἰκοδεσπότης, ὅσπερ ἄρξει
[5] μεγάλου ἀποτελέσματος.

But how one must investigate the lord which has been so found will be said next, (208.) and how much power [it has] from this. For the search for this is long and perhaps more difficult than all others. Sometimes the same [planet] is found to be both lord and house-master, whenever the lord which has been found is itself house-master of the predominator of the luminary, which will [then] rule over [5] a great outcome.

Appendix 8.A: Vettius Valens' Lot Formulae

Valens is our most complete source for interpretation using lots. His work contains not only general delineation of the natal chart using lots, but also a number of predictive techniques. Lots employed in the Anthology include those of Fortune, Daimon, Basis, Eros, Necessity, Exaltation, father, mother, brothers, children, marriage, theft, debt and accusation. Valens gives formulae for all of these along with his interpretations.¹ Here we provide those relevant to the Daimon or mentioned in his delineations.

Lot of Fortune Book II, 3
(Pingree, 58)
ASC + Moon – Sun (D)
[ASC + Sun – Moon (N)]

Lot of Basis Book II, 23
(Pingree, 84)
ASC + Fortune – Daimon *or*
ASC + Daimon – Fortune
(shorter arc, project in zodiacal order from ASC)

Lot of Exaltation Book II, 19
(Pingree, 77)
ASC + Aries – Sun (D)
ASC + Taurus – Moon (N)

Lot of Eros Book IV, 25
(Pingree, 192)
ASC + Daimon – Fortune (D)
ASC + Fortune – Daimon (N)

Lot of Daimon Book II, 23
(Pingree, 83–84)
ASC + Sun – Moon (D)
ASC + Moon – Sun (N)

Lot of Necessity Book IV, 25
(Pingree, 192)
ASC + Fortune – Daimon (D)
ASC + Daimon – Fortune (N)

1 Valens gives different formulae for the lot of marriage than other authors such as Paulus. In connection with lots that involve the *daimōn*, Valens' formulae for the Lots of Eros and Necessity also differ from those of Paulus (discussed in Chapter 10).

Appendix 8.B: Lots according to Antiochus of Athens

(excerpted from his *Thesaurus* by Rhetorius; Ch. 47 copied from Paulus, Ch. 23)

CCAG I, 160.11–28 (similarities with Paulus underlined):

47. Περὶ κλήρων σημασίας.

Σελήνης ὁ κλήρος τῆς τύχης σημαίνει πάντα τὰ ἐπὶ τοῦ σώματος τῶν ἀνθρώπων καὶ τὰς κατὰ τὸν βίον πράξεις καὶ δόξας καὶ τὰ τῆς ψυχῆς πάθη καὶ τὰς συμβιώσεις. Ἡλίου ὁ κλήρος τοῦ δαίμονος σημαίνει τὰ [15] περὶ τῆς ψυχῆς καὶ τρόπου καὶ δυναστείας καὶ ἀξίας καὶ δόξης καὶ θρησκείας. ὤροσκόπου ὁ κλήρος τῆς βάσεως ζωῆς καὶ πνεύματος παραίτιος καθέστηκεν· αὐτὴ γὰρ ἡ βᾶσις πνεύματός ἐστι δοτικὴ τοῦ ὤροσκόπου καὶ τὰ σωματικὰ καὶ τὰς ξενιτείας σημαίνει. Κρόνου ὁ κλήρος τῆς νεμέσεως δαιμόνων χθονίων καὶ κεκρυμμένων πάντων καὶ ἀπο- [20] δείξεως καὶ ἀνδρείας καὶ φυγῆς καὶ ἀπωλείας καὶ πένθους καὶ ποιότητος θανάτου καθέστηκεν. Διὸς ὁ κλήρος νίκης πίστεως καὶ ἐλπίδος ἀγαθῆς καὶ ἀγῶνος καὶ κοινωνίας, ἔτι δὲ καὶ ἐπιβολῆς καὶ ἐπιτυχίας. Ἄρεως ὁ κλήρος τῆς τόλμης θράσους καὶ ἐπιβουλῆς καὶ ἰσχύος καὶ κακουργίας πάσης ἐστὶ δηλωτικὸς. Ἀφροδίτης ὁ κλήρος τοῦ ἔρωτος [25] σημαίνει τὰς ὀρέξεις καὶ ἐπιθυμίας καὶ τὰς κατὰ προαίρεσιν γινομένας φιλίας καὶ χάριτός ἐστι δηλωτικὸς. Ἑρμοῦ ὁ κλήρος τῆς ἀνάγκης σημαίνει συνοχὰς καὶ πολέμους καὶ μίσος καὶ καταδίκας καὶ τὰ ἄλλα πάντα ἐν ἀνθρώποις ἀποτελούμενα βίαια πράγματα.

47. On the meaning of the Lots

The Moon's Lot—the Lot of Fortune—signifies all things in human bodies and the actions in life, reputations, sufferings of the soul and companionship. The Sun's Lot—the Lot of Daimon—signifies things concerning the soul, character, power, worth, reputation and religious rites. The Hour-marker's Lot—the Lot of Basis—is established as responsible for life and breath; for Basis itself is the giver of breath for the Hour-marker, and signifies bodily things and living abroad. Kronos's Lot—the Lot of Nemesis—is established [as responsible for] earthly daimons, all hidden things, [their] exposure, insolence, exile, destruction, grief and the quality of death. Zeus's Lot—the Lot of Victory, for faith, good hope, assembly and community and, moreover, for penalty and reward. Ares' Lot—the Lot of Courage—is indicative of boldness, plotting, strength and every evil work. Aphrodite's Lot—the Lot of Eros—signifies appetites, desires and things that come to be by choice, and it is indicative of friendship and favour. Hermes'

Lot—the Lot of Necessity—signifies imprisonments, wars, enmities, hatreds, condemnations and all the other forcible acts which are brought about by humans.

CCAG I, 161.1–21, 23–25:

[1] 48. Τὰ αὐτῶν ἀποτελέσματα.

Ἡλιος ἐπιβλέπων τὸν κλήρον τοῦ δαίμονος ἀτέκνους ποιεῖ. Ἡλιος λαχῶν τὸν κλήρον τοῦ σίνους καρδιακὸν σίνος ποιεῖ. Ζεὺς θεωρῶν τὸν κλήρον τοῦ δαίμονος ποιεῖ τὸν τοιοῦτον ὑπὸ θεῶν καὶ ἐνυπνίων χρηματισθῆναι καὶ πάντῃ τὰ θεῖα εὐμενῆ ἔξει, κὰν τετραγωνῆ κὰν διαμετρῆ. ὁ κύριος τοῦ κλήρου τῆς τύχης ὕπαυγος ὢν βιοθανάτους ποιεῖ κατὰ τὴν φύσιν τοῦ ζωδίου τοῦ κλήρου τῆς τύχης· ἐὰν δὲ ὀλίγον φύγη τὰς αὐγάς τοῦ Ἡλίου, οὐκέτι βιοθάνατοι γίνονται, ἀλλὰ πλανῆται καὶ πολλὰ δικαζόμενοι. εἰ δὲ ἀγαθοποιοὶ ἐπιθεωρήσωσιν, οὐκέτι βιοθάνατος, [10] ἀλλὰ μέσση τὴν τύχην ἔξει. ὁ κύριος τῆς τύχης καὶ τοῦ δαίμονος ὕπαυγος ὢν βιοθανάτους ποιεῖ κατὰ τὴν φύσιν οὐκ ἀγαθὸς μὲν, οὔτε δὲ πάνυ φαῦλος, ἀεὶ δὲ καλὸς ὡς ἐπίκεντρος. . . .

[17] . . . ἐὰν ὁ

κλήρος τοῦ δαίμονος ἐμπέσῃ ἐν Αἰγοκέρωτι, τὸν γεννηθέντα ποιεῖ ἀνεξίκακον καὶ εὐμετάβλητον· εἰ δὲ Κριῶ ἢ Λέοντι ἢ Σκορπίῳ, ὀξύχο-

[20] λον μονότονον. Ἡλιος ἐπιβλέπων τὸν κλήρον τῆς τύχης καὶ τὸν οἰκοδεσπότην ἔχων ὑπὸ τὰς αὐγάς ἐκπτώτους ποιεῖ. . . .

[23] . . . ὁ οἰκοδεσπότης τοῦ

κλήρου τῆς τύχης κακοδαίμων ὢν καὶ ἐπιβλέπων τὸν κλήρον, κακὸν τὸ

[25] σχῆμα λέγει, μάλιστα δὲ ἐὰν ἦ καὶ ὕπαυγος ἢ καὶ ὑπὸ κακοποιῶν θεωρῆται.

CCAG I, 162.20–22:

[20] . . . ἐὰν ὁ κλήρος

τῆς τύχης ἐμπέσῃ ἐν ἀρσενικῷ ζωδίῳ, τὸν πατέρα προαναιρεῖ, ἐν δὲ θηλυκῷ ζωδίῳ τὴν μητέρα, καθὼς Δωρόθεος.

48. Their Effects

The Sun looking on the Lot of Daimon makes those with no children. The Sun obtaining (as his portion) the Lot of Injury makes cardiac injuries. When Zeus is beholding the Lot of Daimon, such a one receives divine revelation from gods and dreams and will have all divine favors, even if [Zeus beholds it] by square or opposition. When the lord of the Lot of Fortune is under the beams it makes those who die violently, according to the nature of the zodiac sign of the Lot of Fortune. If it escapes the beams of the Sun a little, they will no longer die violently, but will be vagabonds and have many

actions brought against them. If benefics look ahead [at the Lot of Fortune?], he will no longer have a violent death but mediocre fortune. When the lord of Fortune and Daimon is under the beams, it makes a violent death, neither good nor entirely base by nature, but always honourable when on a centrepin. . . .

If the Lot of Daimon falls in Capricorn, it makes the native long-suffering and easily swayed. But if in Aries, Leo or Scorpio, quick to anger and obstinate. The Sun looking upon the Lot of Fortune and having his housemaster [οικοδεσπότης] under the beams makes those who are banished. . . . When the housemaster of the Lot of Fortune is in [the place of the] Bad Daimon, and looks upon the Lot, he says the figure is evil, especially if it [the housemaster] should be under the beams or beheld by malefics. . . .

If the Lot of Fortune falls in a masculine zodiac sign, the father will die first, but if in a feminine zodiac sign the mother, as Dorotheus says.¹

¹ Dorotheus speaks about which parent will die first in 1, 15, but the Lot of Fortune is not mentioned.

Appendix 8.C: The Fifth Consideration, on Lots Rhetorius, Chapter 54, ‘Investigation of Chart Factors’

D. Pingree, ed., unpublished Rhetorius Ms., 39–42 (in preparation by S. Heilen) ≈ CCAg
VIII/4, 120.27–123.6

I have created paragraphs not in the original for ease of reading.

(39.5) Ἐν δὲ τῇ πέμπτῃ σκέψει δέον ζητεῖν τὸν κλῆρον τῆς τύχης καὶ τοῦ
δαίμονος καὶ τῆς βάσεως καὶ τοῦ ὑψώματος τῆς γενέσεως <καὶ τοὺς κυρίους
αὐτῶν> καὶ τὰς φάσεις αὐτῶν καὶ τὰς τοποθεσίας· ἐὰν γὰρ καὶ ἀπόστροφοί
τύχῃσι τοῦ ὠροσκόπου [οἱ ἀποκεκλικότες], ἐπίκεντροι δὲ τῷ κλήρῳ τῆς
τύχης μετὰ τῶν ἀγαθοποιῶν, καλὰ τῇ τύχῃ σημαίνουσιν, εἴπερ ἕξαιγοί
[10] τύχῃσιν. εἰ δὲ τούτων οὕτω κειμένων τὸν ἐνδέκατον τόπον τοῦ κλήρου ἢ τοῦ
ὠροσκόπου (τὸν καλούμενον περιποιητικὸν) κακοποιὸς μόνος θεωρήσει,
<μάλιστα οὐ τῆς αὐτῆς αἰρέσεως καὶ ἄνευ τῆς τοῦ ἀγαθοποιοῦ θεωρίας,
πτῶσιν τῆς τύχης σημαίνει. εἰ δὲ τούτων οὕτως κειμένων ἄλλος τῶν
κακοποιῶν θεωρήσει> τὸν ὄγδοον τόπον τοῦ ὠροσκόπου ἢ τοῦ κλήρου τῆς
[15] τύχης ἢ τὸν κύριον τοῦ ὄγδου τόπου, μετὰ τῆς ἐκπτώσεως καὶ βιοθανασίαν
[16] δηλοῖ τὸ σχῆμα.

[16] εἰ δὲ ὁ κλήρος τῆς τύχης καὶ ὁ κύριος αὐτοῦ καλῶς τύχῃσιν, ὁ
δὲ κλήρος τοῦ δαίμονος καὶ ὁ κύριος αὐτοῦ κακῶς τύχῃσι καὶ ὑπὸ κακοποιῶν θεωρηθῶσιν,
ἔκπτῃσιν τελοῦσι τῇ γενέσει, μάλιστα ἐπὶ νυκτερινῆς γενέσεως
διὰ τὸ κατὰ Πτολεμαῖον κλῆρον τύχης ὑπάρχειν τὸν κλῆρον τοῦ δαίμονος. εἰ
[20] δὲ καὶ ὁ κύριος τοῦ ὑψώματος τῆς γενέσεως κακῶς τύχῃ ἢ ὑπὸ κακοποιῶν
θεωρηθῇ, καθαιρέσεις <τῶν> ἀξιωματῶν ἢ τῶν πράξεων, ἀργίας καὶ
νωχελίας ποιήσει. εἰ δὲ, τοῦ κλήρου τῆς τύχης καλῶς κειμένου καὶ ὑπὸ
(40.1) ἀγαθοποιῶν θεωρουμένου, ὁ κύριος αὐτοῦ εὔρεθῃ ἐν τῷ ἐνάτῳ τόπῳ τοῦ
ὠροσκόπου ἢ ὁ κύριος τοῦ δαίμονος, ἀπὸ ἱερῶν πραγμάτων ἢ ἱερῶν τόπων ὁ
τοιούτος ἐπικτήσεται. εἰ δὲ ἐν τῷ ὑπογίῳ τύχῃ ὁ κύριος τοῦ κλήρου,
θησαυροφύλαξ ὁ τοιοῦτος γενήσεται· εἰ δὲ ἐν καθύγρῳ ζῳδίῳ τύχῃ ὁ κλήρος
[5] τῆς τύχης καὶ ὁ κύριος αὐτοῦ, ἐξ ὑγρῶν πραγμάτων ἢ ναυτικῶν ὁ τοιοῦτος
[6] ἐπικτήσεται.

[6] καὶ ἀπλῶς δέον κατὰ τὴν φύσιν τοῦ ζῳδίου καὶ τὴν τοποθεσίαν
<ἐν ἧ> ἔτυχεν ὁ κλήρος τῆς τύχης καὶ ὁ κύριος αὐτοῦ, ἀποφαίνεσθαι τὰς
[8] εὐδαιμονίας ἢ τοὺς ἐκπτώσεις.

[8] ἐὰν τύχη Ἄρης ἢ Κρόνος ἐν τῷ δωδεκάτῳ τῆς τύχης, εὐρεθῆ δὲ ὁ τῆς αἰρέσεως ἐν ἰδίῳ οἴκῳ ἢ τριγώνῳ ἢ ὑψώματι, ἀπὸ βίας [10] καὶ ἀρπαγῆς τὰς περικτήσεις ποιήσει καὶ ἀδικίας, ἰδὲ δὲ τινὰς ἐσχηματικότητας ἐν τῷ ἕκτῳ τοῦ κλήρου τῆς τύχης καὶ ἀπὸ δουλικῶν προσώπων ἀδικηθέντας καὶ προδοθέντας ὡς διὰ τὸν ἕκτον τόπον· ὁ γὰρ δωδέκατος τόπος τοῦ κλήρου τῆς τύχης ὑπὸ κακοποιῶν μόνον θεωρούμενος μάλιστα καὶ παραιρετῶν σημαίνει τὰς ἐκπτώσεις οὕτως· ὑπὸ μὲν Ἀρέως ἀπὸ ἐμπυρισμῶν ἢ [15] στρατιωτικῶν ἢ ἀρχόντων ἢ ληστρικῶν ἐφόδων ἢ τῶν ὁμοίων· ὑπὸ δὲ Κρόνου ἀπὸ ναυαγιῶν ἢ δικῶν ἢ πρεσβυτέρων προσώπων καὶ ἐκκλησιαστικῶν ἢ εὐνούχων ἢ ἀνασκευῶν τινων χάριν παλαιῶν πραγμάτων [18] ἢ νεκρικῶν προσώπων.

[18] ὁ κλήρος τῆς τύχης καὶ ὁ κύριος αὐτοῦ ἀπόστροφοί τοῦ Ἥλιου ἐκπτώτους ποιούσι δίχα ὁμοζωνίας καὶ τῶν ἰσαναφόρων ζωδίων [20] καὶ τῶν ἰσοδυναμούντων. ἀλλὰ καὶ ὁ κύριος τῆς συνόδου ἢ πανσελήνου ἐν τῷ δωδεκάτῳ <ἦ> ὀγδόῳ τοῦ ὠροσκοποῦ ἐκπτώτους ποιούσιν, ὁμοίως δὲ καὶ ἡ σύνοδος καὶ ἡ πανσέληνος ἐν τῷ δωδεκάτῳ ἢ ὀγδόῳ. καὶ ἐὰν τὰ πλεονα σχήματα καὶ οἱ τούτων κύριοι ἐπὶ <ἀγαθοῦ> τόπου εὐρεθῶσι κεκοσμημένα (41.1) φύσει καὶ σχηματισμοῖς, ἐπίμονα τὰ τοῦ βίου καὶ τὰ τῆς δόξης γενήσονται.

[1] ἢ δὲ χρονιότης <τῆς> εὐτυχίας ἢ δυστυχίας ἢ ἀνωμαλίας ἐκ [τῆς] τῶν περιπάτων καὶ κολλησεων τῶν γινομένων ἀπὸ πάντων τῶν ἀστέρων καὶ τοῦ κλήρου τῆς τύχης καὶ τοῦ δαίμονος. ἀλλὰ δὲ καὶ ἐκ τῆς τοῦ ζωδίου ἀναφορᾶς καθὼς [5] Αἰγύπτιοι, καὶ ἐκ τῆς ἐκάστου ἀστέρος κυκλικῆς περιόδου (τουτέστι τῶν τελείων καὶ μέσων καὶ ἐλαχίστων ἐτῶν) κατὰ τρίτον κλίμα καὶ δίμοιρον τῶν χρόνων (ἦγουν τῶν ἀναφορῶν) τῶν ζωδίων, καὶ <ἐκ> τῶν παραδόσεων καὶ παραλήψεων τῶν ἀστέρων. καὶ ἐὰν μὲν οἱ ἀστέρες κακῶς σχηματίζονται πρὸς τὸν ἀνατολικὸν ὀρίζοντα, καλῶς δὲ πρὸς τὸν κλήρον τῆς τύχης καὶ τὸν [10] κύριον αὐτοῦ, τὰ μὲν πρῶτα ἀπρακτα ἔσται, ἐξ ὑστέρου δὲ πρακτικά. εἰ δὲ ἐναλλάξ τὸ σχῆμα γίνεται καὶ τοῦ ὠροσκοποῦ καὶ τοῦ κλήρου τῆς τύχης καὶ τοῦ κυρίου αὐτοῦ, ἀνάπαλιν τὴν πράξιν ἢ τὴν ἐκπτωσιν λέγει.

[12] ὁμοίως οἱ μὲν κλήροι σημαίνουν τὴν πρώτην ἡλικίαν, οἱ δὲ κύριοι αὐτῶν τὴν τελευταίαν. ἢ μὲν γὰρ τύχη τὰ σωματικὰ πάθη καὶ περικτήσεις σημαίνει, μάλιστα ὁ ια' [15] αὐτῆς τόπος καὶ ὁ κύριος αὐτοῦ, ὁ δὲ δαίμων τὰ ψυχικὰ καὶ τὰς πράξεις καὶ τὰς δόξας καὶ τὸν τρόπον, ὁ δὲ κύριος τῆς βάσεώς ἐστι θεμέλιον τῆς τύχης. μερίζων οὖν τὰ ἔτη τῆς γεννήσεως μὴ μόνον ἀπὸ τοῦ ὠροσκοποῦ τοῦς ἐνιαυτούς δέον ἐκβάλλειν, ἀλλὰ καὶ ἀπὸ Ἥλιου καὶ Σελήνης καὶ κλήρου τῆς τύχης. εἰ δὲ καὶ πατέρα ἔχη καὶ μητέρα, ἐκβάλλε τὰ ἔτη ἀπὸ τοῦ κλήρου τοῦ [20] πατρὸς καὶ τῆς μητρὸς καὶ οὕτως σκέπτου τὸν ἐνιαυτὸν τῶν γονέων. ζῆτει δὲ

μή πως <ό> πλείονα λόγον ἔχων πρὸς τὴν γένεσιν κακῶς πέσῃ ἢ ὑπὸ
κακοποιῶν θεωρηθῇ—καὶ τοῦτο δὲ τὸ σχῆμα φαῦλον ὑπάρχει· κακοθανασίας
(42.1) γὰρ ποιήσει τῇ γενέσει.

[1] μετὰ πάντων δὲ τῶν σχημάτων σκέπτου καὶ τὰ
ἀποτελέσματα τῶν ὀρίων καὶ τὰς τοπικὰς διακρίσεις καὶ τοὺς
συσηματισμοὺς τῶν ἀστέρων καὶ τὰ πρόσωπα τῶν δεκανῶν μετὰ καὶ τῶν
παρανατελλόντων αὐτῶν καὶ τῆς μορφώσεως τῆς δωδεκαώρου· ζῆτει δὲ καὶ
[5] τὸν κύριον τοῦ δωδεκάτου τόπου καὶ τοῦ ἔκτου ἀπὸ ὠροσκόπου μή πως
ἐπίκεντροι τύχωσιν· ὠρονομοῦντες γὰρ βλάπτουσι τὴν νεότητα, δυνόντες δὲ
τὸ γῆρας. ζῆτει δὲ καὶ τὴν Σελήνην <εἰ> μὴ ὀρᾷ τὸν κλῆρον τοῦ ἀναιρέτου
[ἀστέρος]· σημειὸν ἐστὶν τοῦτο βιοθανασίας· λαμβάνεται δὲ ὁ κλῆρος τοῦ
ἀναιρέτου [ἀστέρος] ἀπὸ τοῦ οἰκοδεσπότη τοῦ ὠροσκόπου ἐπὶ Σελήνην καὶ
[10] τὰ ἴσα ἀπὸ ὠροσκόπου, νυκτὸς δὲ ἐναλλάξ.

(p. 39.5) In the fifth consideration (σκέψις), one must seek the Lots of Fortune, Daimon, Basis and Exaltation¹ of the Nativity, <their lords>, their phases and place positions.² For if they happen to be averse from the Hour-marker, but are on centrepins with respect to the Lot of Fortune [and are] with benefics, they signify good things for the [person's] fortune (τύχη), if they happen to be out of the beams. [10] But in these circumstances, if a malefic alone beholds (θεωρέω) the eleventh place from the Lot or the Hour-marker (the so-called 'acquisitive' place), <especially when it [the malefic] is not of the same sect and without the beholding of a benefic, it signifies a fall of the fortune. But if in these circumstances another of the malefics beholds> the eighth place from the Hour-marker or the Lot of [15] Fortune or the lord of the eighth place, it shows the figure with banishment and violent death.

And if the Lot of Fortune and its lord happen to be well [placed], but the Lot of Daimon and its lord badly [placed] and beheld by malefics, they result in banishment for the nativity, especially for a nocturnal nativity, on account of the Ptolemaic Lot of Fortune actually being the Lot of Daimon.³ If [20] the lord of the Exaltation of the

1 The Lot of Exaltation is found in Valens, 11, 19. Its formula is, by day (in a day chart only): Asc + 19°γ - ☉. The nocturnal formula (used only in a night chart) is Asc + 3°ϝ - ☽. The Lot of Exaltation is used in determining eminence for the native. Sometimes in the examples Valens gives, it is clear that he is using only signs, i.e. Aries or Taurus, not the actual degree of exaltation.

2 τοποθεσία, i.e. house position in modern astrological terminology. LSJ, s.v., glosses this word as 'situation, arrangement of heavenly bodies in regions' (meaning 2, citing Valens 42.12 [Kroll; = Pingree, 41.21]), but this seems unnecessarily vague to me, since the Valens example, and those in this passage from Rhetorius, clearly mean the position in a place, a.k.a. house, of the chart.

3 Ptolemy is one of the few (if not the only) authors to use the Lot of Fortune only in its day formula: Asc + ☽ - ☉ (see *Tetrabiblos*, IV, 2). So in a nocturnal chart (where the Sun is below

Nativity also happens to be badly [placed] or beheld by malefics, it will make demolition <of> honours or actions, idleness and sloth. But if, while the Lot of Fortune is well-placed and (p. 40.1) beheld by benefics, its lord is found in the ninth place from the horoscope, or the lord of Daimon [is also found in the ninth], such a person will make further acquisitions from holy matters or holy places; but if the lord of the lot happens to be in the Underground centrepin, such a one will become a treasurer; and if the Lot of Fortune [5] and its lord happen to be in a wet zodiac sign, such a person will make further acquisitions from watery businesses or naval affairs.

And simply, one must proclaim happiness or disappointments according to the nature of the zodiac sign and the place-position <in which> the Lot of Fortune and its lord happened to be.

If Ares or Kronos happen to be in the twelfth from Fortune, and either are found in sect, in his own house, triplicity or exaltation, it will make acquisitions from violence [10] and rape, and injustice.⁴ But know that some configurations in the sixth from the Lot of Fortune also [make] those wronged and betrayed by slave people, as characteristic of the sixth place. For the twelfth place from the Lot of Fortune beheld only by malefics, especially those contrary to sect, signifies disappointments in this way: by Ares, from burnings, [15] military affairs, rulers, attacks by robbers or the like; by Kronos, from shipwrecks, lawsuits, old people and clerics, eunuchs or certain reversals because of past matters or dead people.

The Lot of Fortune and its lord averse from the Sun make those who are banished, excluding congruence and zodiac signs that are equally-ascending [20] and equipollent.⁵ But even the lord of the New or Whole Moon in the twelfth <or> eighth from the horoscope make those who are banished, and likewise the New and Whole Moon in the twelfth or eighth. And if more figures and the lords of these are found on <a good> place, properly ordered (p. 41.1) by nature and configuration, both livelihood and honour will persevere.

The timing <of> good fortune, misfortune or their inconsistency [is found] from circumambulations (περιπατοι), and contacts (κολλήσεις)⁶ of all the stars, the Lot of Fortune and that of Daimon. But also from the ascensions (ἀναφοραι) of the zodiac signs, as [5] the Egyptians generally do, and from the circular period of each star (that

the horizon), what Ptolemy would describe as the Lot of Fortune would actually be the Lot of Daimon.

4 Presumably the violence and rape would be from Ares, and injustice from Kronos.

5 See definitions and diagrams in Appendix I.A.

6 Circumambulations' are advancing planets in the chart by primary direction; 'contacts' are connections of planets by aspect, beginning within a certain orb and continuing up to the time of the exact aspect (see Paulus, ch. 34, Olympiodorus, ch. 38).

is, of the final, middle and least years)⁷ according to the third *klima* and two-thirds of the times (that is, the ascensions) of the zodiac signs, and <from> the handings over (παραδόσεις) and takings up (παραλήψεις) of the stars.⁸ And if the stars are badly configured in relation to the rising horizon, but well [configured] in relation to the Lot of Fortune and [10] its lord, the first [years] will be unproductive, but successful later on. If the opposite figure of the horoscope and the Lot of Fortune occurs, say the reverse for success or disappointment.

Likewise, the lots signify the first age of life, but their lords the last. For Fortune signifies bodily passions⁹ and acquisitions, especially the 11th [15] place from it and its lord; but Daimon things to do with the soul, actions, reputations and character (τρόπος); and the lord of Basis is the foundation-stone of Fortune. And so in apportioning the years (ἔτος) of the birth, one must cast out the years (ἐνιαυτός), not only from the horoscope, but also from the Sun, the Moon and the Lot of Fortune. And if it involves father and mother, cast out the years from the Lot of the [20] Father and Mother, and examine the year for the parents in that way. Make sure that <the one> having more counts does not fall badly in any way in relation to the nativity, or be beheld by malefics—and this figure is actually base; (p. 42.1) for it will make a bad death for the nativity.

With all these figures, also examine the outcomes from the bounds, the place distinctions, the configurations of the stars, the faces of the decans along with their co-risings and the form of the *dōdekaoros*.¹⁰ Make sure also that [5] the lord of the twelfth place and the sixth from the horoscope do not happen to be on centrepins; for when they are administering the hour they harm youth, but when setting [they harm] old age. And also make sure that the Moon does not see the Lot of the Destroyer; this is a sign of violent death. The Lot of the Destroyer is taken from the House-master (οἰκοδεσπότης)¹¹ of the Hour-marker to the Moon, and [10] an equal amount from the Hour-marker, but the reverse at night.

7 Each planet has associated with it three amounts of years, small, medium and large, which are allotted based on conditions in the birthchart. See Appendix 1.A, 2.2, 'Planetary Periods'.

8 Vettius Valens deals extensively with these techniques in Book IV of the *Anthology*.

9 In the original sense of passions, i.e. what is experienced by the body.

10 The *dodekaoros* is a system, originating in Egypt, of assigning animals to each day and night hour; cf. F. Boll, *Sphaera: Neue griechische Texte und Untersuchungen zur Geschichte der Sternbilder* (Leipzig: B. G. Teubner, 1903), 295–345, esp. 295–99 and 317–26. Also see S. Weinstock, 'Lunar Mansions and Early Calendars', *JHS* 69 (1949): 48–69, here 62–69. Also, Chapters 5 and 6 in this volume.

11 This is probably the house-lord of the Ascendant. See Chapter 7 for the different conceptions of the *oikodespotēs*.

Appendix 8.D: Lots according to Paulus Alexandrinus and Olympiodorus

Paulus, *Introduction*, Chapter 23 (Boer, 49.11–50.21):

Εικότως δὲ οἱ κλήροι ταύτην ἔχουσιν τὴν γένεσιν, ἐπεὶ καὶ τῇ φύσει ἢ μὲν Σελήνη Τύχη καθέστηκεν, ὁ δὲ Ἥλιος Δαίμων, ἢ δὲ Ἀφροδίτη Ἔρωσ, ὁ δὲ τοῦ Ἑρμοῦ Ἀνάγκη, ὁ δὲ τοῦ Ἄρεως Τόλμα, ὁ δὲ τοῦ Διὸς Νίκη, ὁ δὲ τοῦ [15] Κρόνου Νέμεσις· ὁ δὲ ὠροσκόπος τούτων ἀνά μέσον βραβεύει, βάσις καθεστὼς τοῦ παντὸς κόσμου.

Καὶ ἢ μὲν Τύχη σημαίνει τὰ περὶ τοῦ σώματος πάντα καὶ τὰς κατὰ βίον πράξεις· κτήσεώς τε καὶ δόξης καὶ προεδρίας δηλωτικὴ καθέστηκεν.

[20] Ὁ δὲ Δαίμων ψυχῆς καὶ τρόπου καὶ φρονήσεως καὶ δυναστείας πάσης κύριος τυγχάνει, ἔσθ' ὅτε δὲ καὶ τῷ περὶ πράξεως λόγῳ συνεργεῖ.

(p. 50.) Ὁ δὲ Ἔρωσ σημαίνει τὰς ὀρέξεις καὶ τὰς ἐπιθυμίας τὰς κατὰ προαίρεσιν γινομένας, φιλίας τε καὶ χάριτος παραιτίος καθέστηκεν.

Ἡ δὲ Ἀνάγκη συνοχὰς καὶ ὑποταγὰς καὶ μάχας καὶ [5] πολέμους, ἔχθρας τε καὶ μίσος καὶ καταδίκας καὶ τὰ ἄλλα πάντα τὰ τοῖς ἀνθρώποις συμβαίνοντα βίαια πράγματα ἐν γέννῃ ποιεῖ.

Ἡ δὲ Τόλμα θράσους καὶ ἐπιβουλῆς καὶ ἰσχύος καὶ κακουργίας πάσης παραιτία καθέστηκεν.

[10] Ἡ δὲ Νίκη πίστεως καὶ ἐλπίδος ἀγαθῆς καὶ ἀγῶνος καὶ κοινωνίας πάσης, ἔτι δὲ καὶ ἐπιβολῆς καὶ ἐπιτυχίας παραιτία καθέστηκεν.

Ἡ δὲ Νέμεσις δαιμόνων χθονίων καὶ τῶν κεκρυμμένων πάντων, ἀποδείξεώς τε καὶ ἀδρανείας καὶ φυγῆς [15] καὶ ἀπωλείας καὶ πένθους καὶ ποιότητος θανάτου παραιτία καθέστηκεν.

Ἡ δὲ βάσις, ὃ ἐστὶν ὠροσκόπος, ζωῆς καὶ πνεύματος παραιτία καθέστηκεν, ἐπειδὴ ἅμα τῷ γεννᾶσθαι πᾶν τὸ γεννώμενον ἐκ τοῦ πνέοντος ἀέρος ἀποσπᾷ τὸ ζωτικὸν

[20] πνεῦμα ἐν τῇ τῆς σταλαγμαϊαίας ὥρας ῥοπῇ τῇ κατὰ τὴν ἀποκύησιν τεταγμένη, ἣτις ἐστὶ τῶν ὄλων δηλωτικὴ.

Suitably, the lots have this origin: since by nature the Moon is set down as Fortune, the Sun Daimon, Aphrodite Eros, the [star] of Hermes Necessity, that of Ares Courage, that of Zeus Victory and that of [15] Kronos Nemesis. The *Horoskopos* judges midway between these, being set as a foundation of the whole cosmos.

And Fortune signifies all things about the body and actions throughout life. It becomes indicative of acquisition, reputation and privilege.

[20] Daimon happens to be lord of soul, temper, sense and every power, and there are times when it cooperates in the reckoning about what one does.

(p. 50) Eros signifies appetites and desires occurring by choice, and it becomes responsible for friendship and favor.

Necessity signifies imprisonments, subordinations, battles and [5] wars, and it makes enmities, hatreds, condemnations and all the other constraining circumstances which happen to men as their lot at birth.

Courage becomes responsible for boldness, plotting, strength and every evil work.

[10] Victory becomes responsible for faith, good expectation, contest and every kind of association, but it becomes as well responsible for penalty and reward [or, “and it becomes as well responsible for enterprise and success”].

Nemesis becomes responsible for earthly daimons and all hidden things, of [their] exposure, impotence, exile, [15] loss, mourning and quality of death.

The foundation, which is the *Horoskopos*, becomes responsible for life and breath, since along with the process of being born, everything which is born tears the life-giving [20] breath from the living air, in the turning-point of the water-clock’s hour which has been set at birth, which is the indicator of the whole.

Olympiodorus, *Commentary on Paulus*, Chapter 21 (Boer, 42.6–43.4):

Καὶ ἰστέον, ὅτι περὶ τούτων τῶν κλήρων γέγραπται
 Ἐρμῆ τῷ Τρισμεγίστῳ ἐν βίβλῳ λεγομένη Παναρέτῳ, ἔνθα
 καὶ τὰ ἀποτελέσματα τούτων παραδίδωσι, δι’ ὧν καὶ μόνων
 ἂν δύναϊτό τις ἀποτελεῖν ἐπὶ ἐκάστου πράγματος χωρὶς
 [10] ἐτέρου τινός.

Οὗτος δὲ ὁ θεῖος ἀνὴρ ζῆλεγεν εἶναι κλήρους πρὸς τὸν ἀριθ-
 μὸν τῶν ζῴστέρων. ἔλεγε γὰρ τὸν κλήρον τοῦ Ἥλιου Ἄγα-
 θὸν Δαίμονα, τὸν δὲ κλήρον τῆς Σελήνης Ἄγαθὴν Τύχην, τὸν
 δὲ κλήρον τοῦ Διὸς Νίκην, τὸν δὲ τοῦ Ἑρμοῦ Ἀνάγκην, τὸν δὲ
 [15] τῆς Ἀφροδίτης Ἐρωτα, τὸν δὲ τοῦ Ἄρεως Τόλμαν, τὸν δὲ
 τοῦ Κρόνου Νέμεσιν. οὐ μάτην δὲ οὕτως ταῦτα ἐθέσπισεν·
 ἀλλ’ ἐπειδὴ οἶα τις τύχη τοῦ παντός ἐστιν ἡ Σελήνη,
 τούτου χάριν τὸν κλήρον αὐτῆς Ἄγαθὴν Τύχην ἐκάλεσε·

καὶ ἐπειδὴ ὁ Ἥλιος ἔφορός ἐστι τοῦ παντός, τούτου
 [20] χάριν τὸν κλῆρον αὐτοῦ Ἀγαθὸν Δαίμονα ἐκάλεσεν·
 ἐπειδὴ πάλιν ὁ Ζεὺς νίκης καὶ δόξης ἐστὶ κύριος, Νίκην
 ἐκάλεσε ὁ Τρισμέγιστος τὸν κλῆρον αὐτοῦ· ἀλλὰ μὴν
 ἐπειδὴ καὶ ὁ Ἑρμῆς κύριός ἐστι λόγου, ὁ δὲ λόγος ἀναγ-
 (p. 43.) καστικός ὑπάρχει, τούτου χάριν Ἀνάγκην ἐκάλεσε τὸν
 κλῆρον αὐτοῦ· ὡσαύτως καὶ τῶν λοιπῶν τοὺς κλήρους
 κατὰ τὴν ἰδιοτροπίαν τῶν ἀστέρων ἐκάλεσεν· καὶ αὐτὰ
 μὲν περὶ τούτου.

And one must know that Hermes Trismegistus has written about these lots in the book called *Panaretus*, in which he hands down the outcomes of these, that through them alone it may be possible for someone to forecast for each matter separately from [10] some other one.

This divine man said there were 7 lots in relation to the number of the 7 stars. For he said the lot of the Sun was the Good Daimon, the lot of the Moon Good Fortune, the lot of Zeus Victory, that of Hermes Necessity, that [15] of Aphrodite Eros, that of Ares Courage, that of Kronos Nemesis. He has not decreed these, in such a way, randomly. But since the Moon is some kind of fortune for everyone, for this [20] reason he called its lot Good Fortune. And since the Sun is overseer of all, for this reason he called its lot Good Daimon. Since, again Zeus is lord of victory and glory, Trismegistus called his lot Victory. Yet truly also since Hermes is lord of *logos*, and *logos* is (p. 43) actually necessary, for this reason he called his lot Necessity. In the same way also he called the lots of the rest of the stars according to their own distinctive quality, and so on.

Commentary on Paulus, Chapter 22 (Boer, 46.8–47.10):

καὶ πρῶτόν γε ἀρξόμεθα ἀπὸ τοῦ
 κλήρου τῆς Τύχης, ἐπειδὴ μᾶλλον αὕτη ἢ θεὸς συγγενεσ-
 [10] τέρα τοῖς τῆδε πέφυκεν αὐξουσα καὶ μειοῦσα τὰ πράγματα,
 ὅθεν καὶ τῆ Σελήνῃ αὐτὴν ὠκείωσεν ὁ θειότατος ἐκεῖνος,
 Ἑρμῆν φημι τὸν Τρισμέγιστον.

Εἶτα μετὰ ταύτην τὸν τοῦ Ἀγαθοῦ Δαίμονος, ἐπειδὴ
 ἦθη ψυχῆς καὶ φρόνησιν καὶ προαίρεσιν ἐκ τούτου δυνάμεθα
 [15] γινώσκειν, ὡσπερ ἐκ τῆς Τύχης περὶ τοῦ σώματος καὶ
 τῶν περὶ τὸ σῶμα. περὶ αὐτὰ δὲ μάλιστα ἡ μεγίστη
 (p. 47.) μαντεία καταγίνεται τοῦ γινῶναι ἦθη ψυχῆς καὶ διαγωγῆν
 σώματος, ταῦτόν δὲ εἰπεῖν, πῶς μὲν ψυχὴ πολιτεύεται κατὰ
 τὸν τῆδε κόσμον, ἄνωθεν ἐλθοῦσα, πῶς δὲ τὸ σῶμα καὶ τὰ

περὶ τὸ σῶμα, καὶ ἀπλῶς εἰπεῖν, πάντα τὰ οὐκ ἐφ' ἡμῖν
 [5] ὑπαντήσει. τούτου χάριν πρὸ πάντων τῶν κλήρων τὸν τοῦ
 Δαίμονος καὶ τῆς Τύχης κλήρον ζητητέον. ἀλλὰ μὴν καὶ
 ἑτέραν αἰτίαν εἶπε, ὅτι διὰ τοῦτο τὸν τοῦ Δαίμονος καὶ τῆς
 Τύχης κλήρον δεῖ προεκβάλλειν, ἐπειδὴ ἀπὸ τούτων καὶ τοὺς
 ἄλλους πάντας ἐκβάλλομεν· οὐκ ἡδυνάμεθα οὖν τούτων μὴ
 [10] ἐκβληθέντων τοὺς λοιποὺς ἐκβάλλειν.

And first indeed we will begin from the Lot of Fortune, since this goddess, much more kindred [10] to things here, has begotten increasing and lessening circumstances, for which reason also that most divine one, I mean Hermes Trismegistus, affiliates her with the Moon.

Then after this the [Lot] of the Good Daimon, since we can [15] get to know the character of the soul, intentional mind and purpose from this [lot], just as [we learn] the body and things concerning the body from Fortune. Especially concerning these things, the greatest power of (p. 47) divination abides with knowing the character of the soul and instruction about the body; that is to say, how a soul, having come from above, is here a citizen in the cosmos, and she will encounter the body and things concerning the body and, speaking generally, all the things which are not up to us.

[5] For the sake of this, one must seek the Lot of Daimon and Fortune before all the [other] lots. Yet there is also another reason, that because of this one must first cast out the Lot of Daimon and Fortune, since from these we cast out all the others. And so we could not cast out the rest [10] without these being looked at.

(Boer, 53.3–16):

Ἐκ τούτων δὲ πάντων δηλοῦται ἡμῖν, ὅτι καθόλου
 ὁ ἀριθμὸς ἢ ἀπὸ ἀστέρων ἐπὶ ἀστέρας γίνεται, ὡσπερ
 [5] ἐπὶ τοῦ Δαίμονος καὶ τῆς Τύχης εἴρηται—ἐκεῖ γὰρ ἀπὸ
 Ἡλίου ἐπὶ Σελήνην καὶ ἀπὸ Σελήνης ἐπὶ Ἥλιον γίνεται
 ὁ ἀριθμὸς, ἀλλὰ μὴν καὶ ἀπὸ τοῦ κλήρου τοῦ πατρὸς
 καὶ τῆς μητρὸς καὶ τῶν λοιπῶν—ἢ ἀπὸ ἀστέρων ἐπὶ
 κλήρους ἢ ἀπὸ κλήρων ἐπὶ ἀστέρας ὡς εἴρηται καὶ ἐπὶ
 [10] τοῦ κλήρου τοῦ Ἐρωτος καὶ τῆς Ἀνάγκης καὶ τῶν
 λοιπῶν ἐπὶ ἡμερινῆς γενέσεως καὶ νυκτερινῆς, ἐπὶ μὲν
 Ἐρωτος καὶ Νίκης ἐπὶ τῶν ἡμερινῶν γενέσεων ἀπὸ
 κλήρου ἐπὶ ἀστέρας, ἐπὶ δὲ νυκτερινῶν τὸ ἀνάπαλιν·
 ἐπὶ δὲ Τόλμης, Ἀνάγκης, Νεμέσεως ἐπὶ μὲν τῶν ἡμερι-
 [15] νῶν γενέσεων ἀπὸ ἀστέρων ἐπὶ κλήρους, ἐπὶ δὲ νυκτερι-
 νῶν ἀπὸ κλήρων ἐπ' ἀστέρας.

From all these it is shown to us that on the whole, the number comes to be either from stars to stars, just as [5] it was said for Daimon and Fortune—for there the number comes to be from the Sun to the Moon and from the Moon to the Sun, yet also as well from the Lot of the Father and Mother and the rest—or from stars to lots or from lots to stars as it was said also for [10] the Lot of Eros and Necessity and the rest for a diurnal and nocturnal nativity. For Eros and Victory on the one hand for diurnal births from lot to stars, but the reverse for nocturnal. But for Courage, Necessity and Nemesis on the other hand, for diurnal [15] births from stars to lots, but for nocturnal from lots to stars.

Appendix 9.A: Julius Firmicus Maternus on the ‘Places’ (Lots) of Fortune and Daemon

Note: I have used the Latin of *KSZ*, with corresponding passages in *Monat* given for convenience. Occasionally I will cite variations or corrections.

Book IV.16.12 (KSZ, I, 237.12–25; Monat, II, 172):

Explicato cursu Lunae et diligenti ratione monstrato ad promissi operis definitionem sermonis intentio transferatur, scilicet ad explicationem Fortunae; non enim omnem possumus fati explicare substantiam, nisi iste locus diligentissima fuerit ratione collectus. Sicut enim in horoscopo quaerimus, quis in eodem loco sit, quis occidat, quis in medio caelo sit, quis in imo, quis in ceteris locis, quatenus etiam dominus ipsius signi sit positus, in quo est horoscopus constitutus, ita et locum Fortunae <debemus> simili ratione colligere. Quo autem in loco sit locus Fortunae, facili ratione monstrabo; quem cum inveneris, inspiciens stellarum omnium societates radiationesque omnem locum istum vero ac fideli poteris explicare iudicio.

Now that the course of the Moon has been explained and shown by careful reckoning, let us transfer our attention to the definition of the promised procedure, namely the explication of Fortune; for we cannot explain the whole substance of fate unless that place is obtained by a most careful reckoning. For just as we seek what is in the same place as the Horoscope, what is setting, what is in the MC, what in the IC, what is in the rest of the places, [and] also how the lord of the sign itself is placed, in what [sign] the Horoscope is set, so also <we ought> to consider the place of Fortune in a similar fashion. But now I shall show by an easy method in what place the place of Fortune is, which when you find it, looking at the associations and gleaming aspects of all the stars,¹ you will be able to explain that place completely with a true and faithful judgement.

1 I.e. planets. When Firmicus uses only the word ‘star’ he means planet; fixed stars are called ‘stellae fixae’.

Book IV.17.1–12 (KSZ, I, 237.26–242.5; Monat, II, 173–77)

17.1–2 (KSZ, I, 237.26–238.8; Monat, II, 173):

XVII. De loco et de efficacia Fortunae

1. In omni genitura nocturna computa a Luna usque ad Solem, in diurna genitura a Sole computa rursus ad Lunam et, quantuscumque signorum <fuerit> numerus, tanta ab horoscopo incipiens signa numera; et quodque signum habuerit novissimum numerum, ipsius signum locum Fortunae demonstrat.

2. Sed haec platica computatio est, quam ideo posuimus, ne quid a nobis praetermissum esse videatur; partiliter vero locus Fortunae ista ratione colligitur, quam tu sequi in omni disputatione debebis.

XVII. On the Place and Efficacy of Fortune

1. In every nocturnal nativity compute from the Moon to the Sun, in a diurnal nativity compute the reverse, from the Sun to the Moon and, whatever the number of signs is, count out that many signs beginning from the Horoscope; and whatever sign has the last number, its sign denotes the place of Fortune.

2. But this platic [i.e. by sign only, not by degree] computation is one we have mentioned so that it does not seem that we have left anything out; but the place of Fortune by degree is obtained by this reckoning which you ought to follow in every computation.

17.2–3 (KSZ, I, 238.8–239.4; Monat, II, 173–74):

2 (cont.). Tunc enim vera definitio [et] in apotelesmatibus proferetur, quotienscumque singula loca partili fuerint ratione collecta. Sic vitam, sic spem, sic fratres, sic parentes, sic filios, sic valitudines, sic coniugem, sic mortem, sic actus, sic amicos, sic inimicos, sic cetera omnia, quaeque in substantia humani generis requirentur, veris definitionibus explicabis. Quae omnia tunc explicabimus, cum ad interpretationem venerimus sphaerae barbaricae; haec enim omnia divinus ille Abram et prudentissimus Achilles verissimis conati sunt rationibus invenire. Sed locus Fortunae, de quo loqui coepimus, partiliter ista ratione colligitur.

3. Si diurnam genituram tractans locum Fortunae coeperis quaerere, hac eum investigato ratione: a parte Solis inchoans omnium signorum partes usque ad illud signum, in quo est Luna, cum ipsis Lunae partibus, [in] quantumcumque totae partes fecerint summam, additis horoscopi <partibus> [inchoans computationem is collegeris,] ab horoscopo incipiens in dexteram partem ab horo- [p. 239.1] scopo signis ceteris divide tricenae partes signis singulis reddens; et in quocumque signo totius numeri <ultima> pars ceciderit, ipse locus Fortunae tibi signum <ac> substantiam demonstrat.

2 (cont.). For then the true explanation will be brought forth in outcomes (*apotelesmatibus*), whenever individual places have been obtained by partile reckoning. Thus you

will set forth with true explanations the life, hope, siblings, parents, children, health, spouse, death, deeds, friends, enemies and all the other things which are demanded in the existence of human kind. We shall develop all these [more] when we come to the *Sphaera barbarica*; for the divine Abram² and most wise Achilles³ tried to find out all these things by the truest reckonings.

3. But the place of Fortune, about which we began to speak, is obtained by degree by this reckoning. If in preparing a diurnal geniture you have begun to seek the place of Fortune, investigate it by this reckoning: beginning from the degree of the Sun, the degrees of all the signs up to that sign in which the Moon is, with the degrees of the Moon themselves, apportion whatever sum all the degrees make, with the degrees of the horoscope added, to the rest of the signs, giving thirty degrees to each, towards the right of the horoscope; and in whatever sign the <last> degree of the whole number has fallen, that place itself denotes for you the sign and substance of Fortune.

17.4 (KSZ, I, 239.4–13; Monat, II, 174):

4. In nocturna vero genitura a Lunae parte incipiens et per signa sequentia simili modo pergens usque ad partem Solis totas signorum colligis partes et additis horoscopi partibus unam numeri facis summam, quam a parte horoscopi incipiens per omnia, quae ab horoscopo sunt, signa dividis singulis signis tribuens xxx, sicut ante diximus, partes; et in quocumque signo totius numeri ultima pars ceciderit, ipsa pars locum tibi Fortunae monstrabit.

But in a nocturnal geniture you collect all the degrees of the signs, beginning from the degree of the Moon and going through the following signs, in a similar way, to the degree of the Sun; and with the degrees of the horoscope added, you make one sum of the number, which you apportion through all the signs which are from the horoscope, beginning from the degree of the horoscope, distributing 30 degrees to the individual signs, as we said before; and in whatever sign the final degree of the total number has fallen, that degree itself will show you the place of Fortune.

2 The Abraham referred to here may be the Jewish patriarch; see B. Ego, 'Abraham [1]', in *DNP*, Band I (Stuttgart/Weimar: J. B. Metzler, 1996), cols 29–30; W. Gundel and H. G. Gundel, *Astrologumena. Die astrologische Literatur in der Antike und ihre Geschichte* (Wiesbaden: Steiner, 1966), 52–53, 182.

3 An Achilles Statius is mentioned in the *Suda* (Suidas, *Suidae Lexicon*, ed. Ada Adler, (Leipzig: B. G. Teubner, 1928–1938), here vol. I, 439, entry 4695) as being the author of a Περὶ σφαίρας. (His name may be Achilles Tatius: see H. W. Schaefer, 'Achilleus Tatios [2]', in *RE*, Band I.1 (Stuttgart: J. B. Metzler, 1894), cols 247–48; K. Brodersen, 'Achilleus Tatios [2]', in *DNP*, Band I (Stuttgart/Weimar: J. B. Metzler, 1996), col. 84.) Perhaps this is the same Achilles who authored the *Introduction to the Phaenomena of Aratus* (see Achilles, *Isagoga*, in *Commentariorum in Aratum reliquiae*, ed. Ernst Maass (Berlin: Weidmann, 1898), 25–75).

17.5–6 (KSZ, I, 239.13–240.6; Monat, II, 174–75):

5. Ex hoc loco qualitatem vitae et patrimonii substantiam et felicitatis atque infelicitatis cursus ostendi datur. Amor etiam et adfectus virorum circa mulieres qualis sit, ex hoc loco discitur et nutrimentorum et desideriorum omnium effectus ex istius loci substantia quaeritur. Hic locus patriam [vel huius loci quadrata latera] facili ratione demonstrat. Appellatur autem, sicut Abraham designat, Lunae locus.

6. Vide ergo dominum totius signi, qui est, et dominum partis istius, idest in cuius stellae finibus ista pars sit et quo in loco sit uterque dominus signi pariter et partis, eius scilicet partis, in qua locus Fortunae fuerit inventus, et in quibus geniturae locis sint constituti, an in principalibus, idest in cardinibus aut in secundis locis, an <in> deiectionibus, an in altitudinibus suis an in domibus an in deiectionibus; et an dominus ipsius signi [et] ex eo loco, in quo est, signum ipsius, idest locum Fortunae oportunitis radiationibus respicit; et si dominus partis ipsius, idest si dominus finium, in quibus locus Fortunae fuerit inventus, ipsam partem ex eo loco, in quo est, opportunitis radiationibus respicit; et si sint ambo invicem sibi cardinaliter iuncti.

5. From this place [*where the lot of Fortune is*] is said to be shown the quality of life, the father's estate, and the courses of both happiness and unhappiness. The quality of love, also, and the affections of husbands toward wives is learnt from this place. Sought from the substance of this particular place, as well, is the effect of nourishment and all desires. This place or the lateral squares of this place denotes, with easy reckoning, the fatherland. Moreover it is called, as Abraham defines it, the place of the Moon.

6. See, therefore, who is the lord of the entire sign, and the lord of the particular degree, that is, in the bounds of what star that degree is and in what place are both the lord of the sign as well as of the degree, namely the degree in which the place of Fortune is found, and in what places of the geniture they have been set—whether in the foremost places, that is, the cardines; or in secondary places, or in cadent ones; or whether they are in their own heights [*i.e. exaltations*] or domiciles or falls. And also whether the lord of the sign itself, from the place it is in, regards its sign, that is, the place of Fortune, with suitable rays; and if both have been joined to each other in a cardine.

IV, 17.7–8 (KSZ, I, 240.6–29; Monat, II, 175–76):

7. Et cum haec omnia diligenti ratione collegeris et sit nocturna genitura, rursus Lunae partes adtende, si diurna vero, Solis et vide, qui sit partium dominus, in diurna scilicet Solis, in nocturna⁴ vero Lunae [Solis vero dominus], et an etiam ipse locum Fortunae cardinali radiatione respicit. Si vero unus harum omnium partium dominus fuerit inventus et bene sit in genitura <positus> et in his, in quibus gaudet, signis vel <in>

4 Misprinted as 'noctura' in KSZ; corrected in Monat.

quibus exaltatur vel [in] quorum est dominus, felicem genituram decernit. Si vero hic est collocatus <cum> Sole <vel> Luna et locum Fortunae respexerit, maior felicitas multiplicata radiatione decernitur. Si vero [h]is cui redditur Luna et locus Fortunae platice si<n>t in cardinibus constituti,⁵ etiam sic felicitas multiplicata radiatione decernitur.

8. Si vero non fuerit unus dominus signi ipsius, in quo est Fortunae locus, et partium, nec partium Solis nec Lunae, ille principatum optinet in decernendo, <qui> habebit maximam potestatem, et si sit benivulus et in benivolis signis fuerit inventus vel in altitudine sua vel in domo sua et in principalibus cardinibus geniturae collocatus locum Fortunae cardinaliter viderit, magnam et nobilem genituram decernit.

7. And when you have obtained all these by a careful reckoning, and the geniture is nocturnal, turn your attention back to the degrees of the Moon, but if a diurnal one [the degrees] of the Sun, and see who is the lord of the degrees, looking of course at the Sun by day and the Moon by night, and whether that one itself also regards the place of Fortune by a cardinal ray [*i.e. from an angle*]. But if one lord is found for all these degrees, and is well <placed> in the geniture and in those signs in which it rejoices, or those in which it is exalted or is lord, it decrees a happy geniture. But if this [planet] is placed <with> the Sun <or> Moon and regards the place of Fortune, more happiness is decreed from this multiple ray. But if these [degrees] which the Moon is ascribed, and the place of Fortune by sign (*platice*) is set, [are] in cardines, even more happiness/fortune is decreed by the multiple ray.

8. But if there is not just one lord for the sign itself in which the place of Fortune is and for the degrees, neither those of the Sun nor the Moon, [then] the one which has the greatest power obtains first place in decreeing; and if it is a benefic and is found in benefic signs or is placed in its own height [*i.e. exaltation*] or house and, located in the principal cardines of the geniture [*the first and tenth?*], sees the place of Fortune cardinally, it decrees a great and noble geniture.

IV 17.9–10 (KSZ, I, 240.29–241.22; Monat, II, 176–77):

9. Sed haec tum facit, si partiliter in cardinibus fuerit constitutus. Si enim generaliter fuerit inventus in his, in quibus diximus, locis, mediam genituram decernit, ut nec ultra modum felix sit nec egestatis angustiis deprimitur. Si vero ambo bene ceciderint, dominus ipsius signi, in quo est locus Fortunae, et dominus partis illius, in qua ultima pars fuerit inventa, et in bonis signis constituti, idest in quibus gaudent vel in quibus exaltantur, vel in domiciliis suis, et partiliter in cardinibus fuerint collocati, tantas decernit felicitates, ut is, qui sic natus fuerit, imperatoribus omni genere coniungatur.

5 This sentence is rather corrupt in both KSZ and Monat; I have emended 'qui' to 'cui' and 'constitutus' to 'constituti' along with the other changes noted. KSZ in the *apparatus criticus* say '*possis* viderit Lunam'. Monat (176) says '8.4 qui *add. Ven. Ksz*' [Kroll Skutsch Ziegler].

Sin vero in signis cardinum non partiliter, sed platice fuerint inventi, mediae felicitatis incrementa decernunt.

10. Si vero dominus ipsius signi, in quo est Fortunae locus inventus, sed et dominus partis ipsius, idest finium dominus, et dominus partium earum, in quibus <in> eadem genitura Luna fuerit inventa, bene fuerint collocati, vel in quibus exaltantur vel in domiciliis suis, et principalia geniturae possederint loca vel in his, in quibus gaudent, locis fuerint collocati, facient imperatores, sed quorum imperium per totius orbis spatia dirigatur et quorum tanta potestas sit, ut ad deorum numen accedant.

9. But it then does these things only if it is set in the cardines by degree. For if it is just found generally [*i.e. platically*] in these places about which we have spoken, it decrees a middling geniture, that he will not be happy beyond measure nor weighed down by extreme poverty. But if both fall well—the lord of the sign itself in which the place of Fortune is, and the lord of that degree in which the final portion is found, and set in good signs, that is, in which they rejoice or are exalted, or in their own houses, and placed by degree in cardines, it decrees such happiness that one who has been thus born is joined to emperors in every way. But if not in cardinal signs by degree, but are found [only] by sign, they decree increases of a moderate happiness.

10. But if the lord of the sign itself in which the place of Fortune is found, and the lord of the degree itself (that is, the lord of the bounds), and the lord of the degrees in which the Moon is found in the same geniture are well placed, either in [signs] where they are exalted or in their own houses, and they hold the principal places of the geniture or are set in those places in which they rejoice, they will produce emperors whose empire spreads throughout the whole world and whose power is such that they approach the divine sway of the gods.

IV 17.11–12 (KSZ, I, 241.22–242.5; Monat, II, 177);

11. Si vero istarum stellarum, quarum fecimus mentionem, nulla bene ceciderit, is, qui sic natus fuerit, usque ad ultimum vitae diem infelicitatis onere deprimetur. Quod cum fuerit, inspicere partiliter MC et hoc signum, quod in anafora horoscopi sit; et si nulla ex illis stellis, quarum mentionem fecimus, bene fuerit collocata, vide an in MC vel in anafora horoscopi benivola stella conditionis suae secuta potestatem inveniatur; nam si inventa fuerit, praecedentis mali processu temporis infortunium corrigetur.

12. Si vero illis tribus, quibus ante diximus, [p. 242] male positus MC et anafora horoscopi omnium benivolarum stellarum praesidio relinquatur, infelix misera et omni malorum erit ista genitura continuatione depressa. Sed et Fortunae duodecatemorium diligenter inquire, ne te apotelesmatum fallat intentio.

11. But if, of the stars we have mentioned, none falls well, the one born thus will be weighed down until the last day of his life by the burden of misfortune. When this happens, look at the MC by degree and the sign which ascends after the Hour-marker;

and if none of these stars which we have mentioned are well placed, look at whether a benefic star in the power of its own sect is found in the MC or in the sign ascending after the Hour-marker; for if it is so found, the misfortune of the preceding evil will be corrected in the progression of time.

12. But for those three which we spoke of before, if they are badly placed, and the MC and post-ascension of the Hour-marker are left free from the protection of all the benefic stars, this geniture will be unfortunate, unhappy and weighed down by an ever-continuing succession of evils. So inquire carefully about the twelfth-part of Fortune, so that the aim of the effects [of the chart] does not escape your notice.

Book IV 18.1 (KSZ, I, 242.6–21; Monat, II, 178):

XVIII. De loco daemonis

Locum daemonis ista ratione colligimus; quam ideo huic libro indidimus, quia Solis eum locum esse Abraham simili ratione monstravit et inicum erat, ut a loco Lunae Solis separaretur locus. Qui locus hac ratione colligitur: [ut] in diurna genitura a parte Solis usque ad partem Lunae omnium signorum colligis partes et totam hanc summam ab horoscopo incipiens per sequentia signa distribuis, et in quocumque signo ultima pars ceciderit, ipsa tibi pars daemonem monstrat. In nocturna vero a Luna usque ad Solem omnium signorum colligis partes et omnem istam summam ab horoscopo incipiens simili ratione totis dividis signis, et in quocumque signo <pars ultima ceciderit, ipsa tibi> pars geniturae daemonem monstrat.

XVIII. On the place of the Daemon

We obtain the place of the daemon by this reckoning; we have introduced it [*the place*]⁶ in this book, because Abraham showed it to be the place of the Sun by a similar reckoning and it was unsuitable that the place of the Sun be separated from the place of the Moon. The place is obtained by this reckoning: in a diurnal geniture you collect the degrees of all the signs from the degree of the Sun to the degree of the Moon, and beginning from the Horoscope you distribute this entire sum through the following signs, and in whatever sign the final degree falls, that degree itself shows you the Daemon. In a nocturnal [geniture] you collect the degrees of all the signs from the Moon to the Sun and beginning from the Horoscope, by like reckoning you apportion that entire sum to all the signs, and in whatever sign <the last degree falls, that> degree itself shows you the Daemon of the geniture.

6 Reading 'quem', in all the manuscripts, for 'quam' in the Aldine edition. Thanks to Charles Burnett for bringing this to my attention.

iv.18.2 (KSZ, I, 242.21–28; Monat, II, 178):

Hic locus vocatur et animae substantia; ex hoc loco actus omnisque augmenta substantiae quaerimus [invenimus], et ostendit, qualis circa virum mulieris sit adfectus. Sed et hic locus et quadrata latera ipsius loci patriam nobis manifesta ratione demonstrat. Vide ergo, locum hunc quae malivolae stellae, quae benevolae respiciant, et sic apotelesmata pro singularum stellarum testimoniis explica.

This place is also called the substance of the soul; from this place we seek actions and increases of all substance. It shows what sort of affection there is of a wife toward her husband. But this place and its lateral squares denote with clear reckoning the fatherland to us. See, therefore, what malefic and what benefic stars regard this place, and thus explain the outcomes by the testimonies of individual stars.

Appendix 9.B: Valens' Melothesia from the Lots of Fortune and Daimon

Book II, 37.1–5 (Pingree, 103.28–104.12):

Περὶ σίνους καὶ πάθους μεθ' ὑποδειγμάτων καθ' ἕνα σίνον
ζώδιον, οἷον· ὁ Κριὸς τί ποιεῖ σίνος ἢ πάθος, καὶ τὰ ἐξῆς αὐτοῦ
[30] Ἐπειδὴ σκοτεινῶς οἱ παλαιοὶ τὸν περὶ σίνους τόπον ἔγραψαν, προφα-
νέστερον ἐπιδιασαφήσομεν. τινὲς μὲν οὖν τοῖς ὑποκειμένοις τόποις σωμα-
τικοῖς τε καὶ ψυχικοῖς προσέχοντες, κατὰ τὴν ἐκάστου γένεσιν τὴν ἀρχὴν
(p. 104) ποιοῦμενοι τῶν μελῶν ἀπὸ κλήρου τύχης καὶ δαίμονος, τὸν περὶ σίνους
καὶ πάθους τόπον πρὸς τὴν τῶν κακοποιῶν παρουσίαν ἀποφαίνονται.
οἷον ὁ κλήρος τῆς τύχης στηθός, τὸ β' πλευρόν, τὸ γ' κοιλία, τὸ δ' ἰσχία,
τὸ ε' μόριον, [καὶ] τὸ ζ' μηροί, τὸ ζ' γόνατα, τὸ η' κνήμαι, τὸ θ' πόδες,
[5] τὸ ι' κεφαλὴ, τὸ ια' πρόσωπον, τράχηλος, τὸ ιβ' πῆχεις, ὦμοι. τὰ δὲ πάθη
ἀπὸ τοῦ δαίμονος· αὐτὸς γάρ [οὗτος] ὁ δαίμων ἐστὶ καρδιά, τὸ β' ζώδιον
ἢ ἐντὸς κοιλία, τὸ γ' δι' οὗ τὸ σπέρμα φέρεται καὶ νεφρῶν τόπος, τὸ δ'
κόλον, τὸ ε' ἦπαρ, τὸ ζ' β' κοιλία, τὸ ζ' κύστις, τὸ η' ἔντερα, τὸ θ' μη-
νίγγων τόπος καὶ ὀδόντων καὶ ἀκοῆς, τὸ ι' ἢ κατάποσις, τὸ ια' γλῶσσα,
[10] τὸ ιβ' στόμαχος. ταῦτα δὲ κατὰ τὸν Λέοντα καὶ Καρκίνον ἀκολούθως
δεδήλωται, ἐπεὶ ἢ μὲν Σελήνη τύχη τοῦ κόσμου ἐστίν, ὁ δὲ Ἥλιος νοῦς
καὶ δαίμων.

37. On injury and illness, with illustrations from each zodiac sign, such as: what injury or illness Aries makes, and so on

Since the ancients wrote obscurely about the place of injury, we shall make it more explicit. Some, then, who focus their attention on the affected places of the body and the soul, making, for each person's nativity, the beginning of the [assignment of] body parts from the Lots of Fortune and Daimon, present the place of injury and illness in reference to the presence of malefics. Such as, the Lot of Fortune the breast, the 2nd [from it] the rib, the 3rd the belly, the 4th the hips, the 5th the little part [*the genitals*], the 6th the thighs, the 7th the knees, the 8th the shins, the 9th the feet, the 10th the head, the 11th the face [and] neck, the 12th the arms [and] shoulders. The illnesses [are] from the [Lot] of Daimon, for the Daimon itself is the heart, the 2nd zodiac sign [from it] the innards, the 3rd that through which the sperm is carried and place of the kidneys, the 4th the colon, the 5th the liver, the 6th the second belly [*the womb?*], the 7th the bladder, the 8th the intestines, the 9th the place of membranes, teeth and ears, the 10th the gullet, the 11th the tongue, the 12th the stomach. These are shown

analogically with Leo [*for Daimon*] and Cancer [*for Fortune*], since the Moon is the fortune of the cosmos, and the Sun mind and daimon.

[But Valens does not use this system because, he tells us, his experience has given better results using the usual melothesia of each sign. He proceeds to describe these, stating both the injuries and illnesses for each sign. After this, he explains how to use this system with the lots:]

Book II, 37.20–25 (Pingree, 105.35–106.15):

[35] Τούτων οὕτως ἐχόντων σκοπεῖν δεήσει ἀκριβῶς ἐπὶ πάσης γενέσεως
(p. 106) τὸν κλήρον τῆς τύχης, εἰς ποῖον ζῴδιον ἐξέπεσεν (καὶ ἢ τοῦ ζῴδιου φύσις
σημαίνει τὸ σίνος), μάλιστα δὲ ὁ τοῦ κλήρου τῆς τύχης κύριος ἐν ὁποίῳ
ἂν ᾖ ζῴδιῳ. ὁμοίως δὲ καὶ τὸν δαίμονα καὶ τὸν τούτου κύριον σκοπεῖν,
εἰς ποῖα ζῴδια ἐξέπεσεν (καὶ οὗτοι τὰ πάθη δηλώσουσιν) · καὶ <οἱ> εἰς
[5] τὸν περὶ πράξεως τόπον ὡσαύτως σοι νοηθήσονται. ἐνεργέστερα μὲν οὖν
τὰ σίνη καὶ τὰ πάθη γινήσεται, ἐπὶ ἀκακοποιοὶ ἐπῶσιν ἢ μαρτυρῶσι
τοῖς τόποις ἢ τοῖς οἰκοδεσπόταις· γίνονται δὲ ἀσινεῖς ἢ ἀπαθεῖς ὅταν κα-
λῶς οἱ τόποι καὶ οἱ κύριοι ἀκάκωτοι τύχωσιν. ἕκαστος μὲν οὖν ἀστήρ τὸ
ἴδιον ἀποτέλεσμα ποιεῖ ἐξ ἧς ἔλαχε φύσεως. ἐὰν γὰρ ὑποθέσεως χάριν
[10] ὁ κλήρος εἰς Κριὸν ἐμπέσῃ καὶ ὁ τούτου κύριος Ἄρης ἐπῆ, <ἐπει> καὶ τοῦ
Κριοῦ καὶ τοῦ Σκορπίου ἐκυρίευσεν, προλέγειν σίνος περὶ κεφαλῆν ἢ
μόριον ἢ ἔδραν. ὅσον εἴωθε κατὰ τὴν ἰδίαν φύσιν ὁ ἀστήρ ἀποτελεῖν ἀπο-
τελέσει· ἔσθ' ὅτε γάρ, ἀμφοτέρων τῶν τόπων κακωθέντων, τὰ σίνη καὶ
τὰ πάθη γίνονται, καὶ μάλιστα ὅταν κακοποιοὶ κυριεύσωσιν ἢ ἐπιμαρτυ-
[15] ρήσωσιν.

Such being the case, it will be necessary to examine the Lot of Fortune accurately for every nativity, in what zodiac sign it fell out (and the nature of the sign signifies the injury), and especially the lord of the Lot of Fortune in whatever zodiac sign it is. And likewise examine the [Lot of] Daimon and its lord, in what zodiac sign it fell out (and these show the illnesses). And you will discern them likewise from the place concerning action [*i.e. the tenth*]. So the injuries and illnesses will come to be more activated whenever malefics are on or witnessing the places or their house-masters; but the [natives] come to be uninjured or free of illness when the places and their lords happen to be well-[placed] and free of malefics. And so each star produces its own particular outcome from the nature it had as its portion. For instance, if the lot falls in Aries and its lord, Ares, is there, <since> it has authority over Aries and Scorpio, it foretells injury to the head or [private] parts or fundament. The star will bring about whatever it is accustomed to bring about according to its own nature; but sometimes, when both places have been afflicted, [both] injuries and illnesses occur, especially when malefics are the lords or testify.

Appendix 9.C: Planetary Years for Time Lords in Vettius Valens (Minor Years of the Planets)

Sign of Lot	Planet	Years	Months
Aries	Mars	15	15 (1y3m)
Taurus	Venus	8	8
Gemini	Mercury	20	20 (1y8m)
Cancer	Moon	25	25 (2y1m)
Leo	Sun	19	19 (1y7m)
Virgo	Mercury	20	20 (1y8m)
Libra	Venus	8	8
Scorpio	Mars	15	15 (1y3m)
Sagittarius	Jupiter	12	12 (1y)
Capricorn	Saturn	27	27 (2y3m)
Aquarius	Saturn	30	30 (2y6m)
Pisces	Jupiter	12	12 (1y)

The domicile lord of the lot begins the aphesis. Each planet allots its minor years for the complete cycle. These years are divided up into months each ruled by the lords of the succeeding signs in order. The major lord is first in this order, allotting the same amount in months as it does in years.

An Example of This System

The lot is in Scorpio. Mars is the ruler of the lot in question.

The first period is then 15 years. Of those 15 years, the allotment is:

Sign of Lot	Planet	Months
Scorpio	Mars	15 months (1 year 3 months)
Sagittarius	Jupiter	12 months (1 year)
Capricorn	Saturn	27 months (2 years 3 months)
Aquarius	Saturn	30 months (2 years 6 months)

Sign of Lot	Planet	Months
Pisces	Jupiter	12 months (1 year)
Aries	Mars	15 months (1 year 3 months)
Taurus	Venus	8 months
Gemini	Mercury	20 months (1 year 8 months)
Cancer	Moon	25 months (2 years 1 months)
Leo	Sun	<u>4 months of its 19 months</u> =15 years

The next period will begin after 4 months of the sub-Leo period. Jupiter will be the next major period ruler.

Appendix 10.A: Orphic Hymns to Eros, Tyche and Daimon

From *The Orphic Hymns*. Translated, introduction and notes by Apostolos N. Athanassakis and Benjamin M. Wolkow. Baltimore: The Johns Hopkins University Press, 2013, 47–48, 57–58. Used with permission.

Greek text from W. Quandt, ed., *Orphei hymni*, 3rd ed., Edited by Wilhelm Quandt. Berlin: Weidmann, 1955, repr. 1973.

Translation of Athanassakis and Wolkow, slightly modified.

Hymn 58, To Eros

Ἔρωτος, θυμίαμα ἀρώματα.

Κικλήσκω μέγαν, ἀγνόν, ἐράσμιον, ἠδὺν Ἔρωτα, (1)
τοξαλκῆ, πτερόεντα, πυρίδρομον, εὐδρομον ὀρμηί,
συμπαίζοντα θεοῖς ἠδὲ θνητοῖς ἀνθρώποις,
εὐπάλαμον, διφυή, πάντων κληΐδας ἔχοντα,
αἰθέρος οὐρανοῦ, πόντου, χθονός, ἠδ' ὅσα θνητοῖς (5)
πνεύματα παντογένεθλα θεὰ βόσκει χλοόκαρπος,
ἠδ' ὅσα Τάρταρος εὐρύς ἔχει πόντος· θ' ἀλίδουπος·
μῦνος γὰρ τούτων πάντων οἴηκα κρατύνεις.
ἀλλά, μάκαρ, καθαρὰς γνώμεις μύσαισι συνέρχου,
φαύλους δ' ἔκτοπίους θ' ὀρμάς ἀπὸ τῶνδ' ἀπόπεμπε. (10)

To Eros

Incense: aromatic herbs

I call upon great, pure, lovely and sweet Eros,
winged archer who runs swiftly on a path of fire
and plays together with gods and mortal men.
Inventive and two-natured, you are master of all,
[5] of the heavenly ether, of the sea and the land,
of the all-begetting winds which for mortals are nurtured
by the goddess of grass and grain,
and of all that lies in Tartaros and in the roaring sea.
You alone govern the course of all these.

But, blessed one, come to the initiates with pure thought,
[10] and banish from them vile impulses.

Hymn 72, To Tyche

Τύχης, θυμίαμα λίβανον.
Δεῦρο, Τύχη· καλέω σ', ἀγαθῶν κράντειραν, ἐπευχαίς, (1)
μειλιχίαν, ἐνοδίτιν, ἐπ' εὐόλβοις κτεάτεσσιν,
Ἄρτεμιν ἠγεμόνην, μεγαλώνυμον, Εὐβουλήος
αἵματος ἐκγεγάωσαν, ἀπρό<σ>μαχον εὐχος ἔχουσαν,
τυμβιδίαν, πολύπλαγκτον, ἀοίδιμον ἀνθρώποισιν. (5)
ἐν σοὶ γὰρ βίωτος θνητῶν παμποικιλός ἐστιν·
οἷς μὲν γὰρ τεύχεις κτεάνων πλήθος πολυόλβον,
οἷς δὲ κακὴν πενήνην θυμῶι χόλον ὀρμαίνουσα.
ἀλλά, θεά, λίτομαί σε μολεῖν βίωι εὐμενέουσαν,
ὄλβοισι πλῆθουσαν ἐπ' εὐόλβοις κτεάτεσσιν. (10)

To Tyche

Incense: frankincense

I summon you here through prayer, Tyche, noble ruler,
gentle goddess of the roads, for wealth and possessions,
I summon you as Artemis who guides, renowned, sprung from the loins
of Eubouleus. Your wish is irresistible.
[5] Funereal and delusive, you are the theme of men's songs.
In you lies the great variety of men's livelihood.
To some you grant a wealth of blessings and possessions,
to others you bring evil poverty if you harbour anger against them.
O goddess, I beseech you, come in kindness to my life
[10] grant me happiness, grant me abundant riches.

Hymn 73, To the Daimon

Δαίμονος, θυμίαμα λίβανον.
Δαίμονα κυκλήσκω † μέγαν ἠγήτορα φρικτόν, (1)
μειλίχιον Δία, παγγενέτην, βιοδώτορα θνητῶν,
Ζῆνα μέγαν, πολύπλαγκτον, ἀλάστορα, παμβασιλίαν,
πλουτοδότην, ὅπότεν γε βρυάζων οἶκον ἐσέλθηι,
ἔμπαλι δὲ τρύχοντα βίον θνητῶν πολυμόχθων· (5)
ἐν σοὶ γὰρ λύπησ τε χαρὰς † κληῖδες ὀχοῦνται.
τοιγὰρ τοι, μάκαρ, ἀγνέ, πολύστονα κήδε' ἐλάσσας,
ὄσσα βιοφθορίην πέμπει κατὰ γαίαν ἅπασαν,
ἔνδοξον βιοτῆς γλυκερὸν τέλος ἐσθλὸν ὀπάζεις.

To the Daimon

Incense: frankincense

I call upon Daimon, the grand and dreaded leader,
gentle Zeus, who gives birth to all and livelihood to mortals;
great Zeus, wide roving, avenger, king of all,
giver of wealth when you enter the house, laden with goods,
[5] you refresh the life of mortals worn out with toil.
You possess the keys to joy and sorrow as well.
So, O pure and blessed one, drive painful cares away,
cares that are life-destroying throughout the whole earth,
and bring a glorious, sweet and noble end to life.

Appendix 10.B: Formulae for the Lots of Eros and Necessity

(D = Day formula, N = Night formula)

Egyptian Formulae

Vettius Valens

Eros	D from Fortune to Daimon: Asc + Daimon – Fortune N from Daimon to Fortune: Asc + Fortune – Daimon
Necessity	D from Daimon to Fortune: Asc + Fortune – Daimon N from Fortune to Daimon: Asc + Daimon – Fortune

Firmicus Maternus

Cupid (Eros)	D from Daimon to Fortune: Asc + Fortune – Daimon N from Fortune to Daimon: Asc + Daimon – Fortune
Necessity	D from Fortune to Daimon: Asc + Daimon – Fortune N from Daimon to Fortune: Asc + Fortune – Daimon

Abū Ma'shar (Greater Introduction)

Love and Harmony	D from Fortune to Daimon: Asc + Daimon – Fortune N from Daimon to Fortune: Asc + Fortune – Daimon
Poverty and Slight Intellect	D from Daimon to Fortune: Asc + Fortune – Daimon N from Fortune to Daimon: Asc + Daimon – Fortune

al-Bīrūnī

Friendship And Love	D from Fortune to Daimon: Asc + Daimon – Fortune N from Daimon to Fortune: Asc + Fortune – Daimon
Despair and Penury and Fraud	D from Daimon to Fortune: Asc + Fortune – Daimon N from Fortune to Daimon: Asc + Daimon – Fortune

Hermetic Formulae

Paulus Alexandrinus and Olympiodorus

Eros D from Daimon to Venus: Asc + Venus – Daimon
 N from Venus to Daimon: Asc + Daimon – Venus

Necessity D from Mercury to Fortune: Asc + Fortune – Mercury
 N from Fortune to Mercury: Asc + Mercury – Fortune

Abū Ma'shar (De rev. nat.)

Intellect and D from Mercury to Fortune: Asc + Fortune – Mercury
 Native Wit N from Fortune to Mercury: Asc + Mercury – Fortune

Appendix 10.C: Extant Charts Using the Lots of Eros and Necessity

Note: Since the new chart of 319 CE is still in preparation by Alexander Jones, I cannot provide the text at this time.
(In the following charts, Greek text relevant to the lots is given.)

1. No. 138/161, in *Greek Horoscopes*, 44–45

P. Princeton 75; dated ca. 138 (161?) CE

Nocturnal chart

Uses Egyptian bounds

Uses Egyptian/Firmicus formulae for Lots of Eros and Necessity

Greek text:

- [2] [ο κ]ληρος της τυχης ευρεθη καρκινω μοιρων ιγ οικω ce
- [3] [ληνης οριο]ις ερμου ουτος σημαινει μετρον της τυχης
- [4] [ο κλ]ηρος ο του δαιμονος ευρεθη αιγογερω μοιρων κζ οικω
- [5] [κρονου οριοις αρεω]ς ουτος σημαινει τον περι ηθους και αγωγης τροπων
- [6] [ο κληρος ε]ρωτος ευρεθη ταυρω μοιρων δ οικω και οριοις α
- [7] [φροδειτης ουτος σημαιν]ει τον περι φιλιας και συστασεως
- [8] [ο κληρος] της αναγκης ευρεθη κριω μοιρων ζ οικω αρεως
- [9] [οριοις διος ου]τος σημαινει τον περι εκχθρων και παντοδαπου
- [10] [δυςτυχημα]τος. . .

2. No. 338, in *Greek Horoscopes*, 65–66

PSI 23,a; dated 338 CE

Nocturnal chart

Uses Egyptian bounds

Uses Egyptian/Valens formulae for Lots of Eros and Necessity

Greek text:

- [13] κληρος τυχης παρθενω μυρ/ κθ [27] οικου ερμου οριοις κρονου διμ/ γ
- [14] κλ(ηρος) δαιμονος διδ[υ]μοις μυρ/ κ [28] οικου διος οριοις αφροτιδη διμ/ β
- [15] κλ(ηρος) ερωτος τοξ[ο]της μυρ/ ιε [29] οικου αρεως οριοις ερμου διμ/ β
- [16] κλ(ηρος) αναγκης τ[αυρω] μυρ/ ι λε θ [30] οικου ερμου οριοις αρεως διμ/ γ

Possible alternative line arrangement:

- [13] κληρος τυχησ παρθενω μυρ/ κθ [27] οϊκου ερμου οριοισ κρονου διμ/ γ
 [14] κλ(ηρος) δαιμονοσ διδ[υ]μοισ μυρ/ κ [30] οϊκου ερμου οριοισ αρεωσ διμ/ γ
 [15] κλ(ηρος) ερωτοσ τοξ[οτ]ησ μυρ/ ιε [28] οϊκου διοσ οριοισ αφροτιδη διμ/ β
 [16] κλ(ηρος) αναγκησ τ[αυρω] μυρ/ ι λε θ [29] οϊκου αρεωσ οριοισ ερμου διμ/β

3. P.Oxy. 4277, in *Astronomical Papyri from Oxyrhynchus*, vol. 1, 286 (commentary), vol. 2, 424, 426 (text)

Dated perhaps late 2nd–early 3rd century CE

Nocturnal chart

Uses Egyptian/Valens formulae for Lots of Eros and Necessity

Greek text:

- [12] κ[λ]ήροσ τύχησ
 ὁ πρῶτοσ κλήροσ ὁ καλοῦμενοσ τύ-
 χησ εὐρέθη τὴν κατὰ μῆκοσ [κίνησιν]
- [15] ποιούμενοσ ἐν ζωδῖ[ω θ]η[λ]υκῶ
 ἀνθρωποειδῆ Παρθένω [ἐν] μο[ι]ρα[ι]σ [ζ?]
 λεπ[τοί]σ [τῆ]σ [ἐ]ξηκοντάδ[ο]σ . . ., [οἴκω Ἐρ-]
 μού, ὑψώματι αὐτοῦ [c. 10 letters]
 Ἀφροδείτησ ταπεινώματι [c. 6 letters]
- [20] ὀριοισ Ἀφροδείτησ, μονομοιρίῃ Ἐρ[μοῦ],
 ἐπεὶ τμήματοσ δ, ἐπεὶ βαθμῶ . . ., [ἀνε-
 μῶ Λίβει, δεκανῶ ἄ.
 κ[λ]ήροσ δαίμ]ονοσ
 ὁ δεῦτεροσ [κλήροσ ὁ καλοῦμενοσ δαί-]
- [25] μων εὐρέθη τὴν [κατὰ μῆκοσ κίνησιν
 ποιούμεν[ο]σ ἐν ζωδίω στερέω βασιλι-
 κῶ Λέοντι ἐν [μο[ι]ρα[ι]σ] . . . λεπ[τοί]σ τῆσ ἐξηκοντά-
 δοσ ις, οἴκω [ἡλίου, τριγώνω Διοσ κα-
 τὰ μέτοχον Ἄρεωσ, ὀριοισ ?,
- [30] μονομοιρίῃ [?], ἐπὶ τμήματοσ . . .,
 ἐπεὶ βαθ[μ]ῶ . . ., ἀνεμῶ ?, δεκα-
 νῶ ἄ.
 [κλήροσ ἔρωτοσ?]
- ὁ τρί[το]σ κλήροσ ὁ ἔρωτοσ εὐρέθη
- [35] τὴν [κατὰ μῆκοσ κίνησιν ποιούμενοσ

Fr. 1, col. iii

ἐν ζῶ[δί]ω θηλυ[κῶ] ἀνθρωποειδεῖ

Παρθένω (traces)

[3–5] (traces)

[6] ἄνεμῶ Λίβε[ι]

κλήρο[ς] ἀνάγκη

[ὁ] τέτα[ρ]τος κλήρος ὁ καλούμενος

[ἀ]νάγκη[ς] εὐρ[έθη] τῆ[ν] κατὰ μήκος

(no further traces visible)

4. The Nativity of Constantine VII Porphyrogenitus, in D. Pingree, 'The Horoscope of Constantine VII Porphyrogenitus', *Dumbarton Oaks Papers*, 27 (1973): 217 + 219–31.

Dated 905 CE

Diurnal chart

Uses Egyptian/Firmicus formulae for Lots of Eros and Necessity

The following relates to the positions of the lots:

(p. 223) III.2, ll. 6–7:... ἡ Σελήνη μετὰ τοῦ κλήρου τοῦ δαί<μονος> τυχοῦσα εὐτροφον σημαίνει τὸ τεχθέν... .

... the Moon being with the Lot of Dai<mon> signifies the child is well-nourished... .

IV.1, ll. 2–3: Ἐπὶ τῆς προκειμένης γενέσεως ἀμφοτέρων ἀποκεκλιό<των> τῶν φώτων... .

For the aforetelling nativity, since both of the lights have declined [i.e., are cadent]... .

IV.3, ll. 7–8: ὑπάρχει ὠροσκόπος Ζυγοῦ ε̄ κγ̄... .

The Hour-marker is actually in Libra 5 23... .

(p. 224) v.1, ll. 2–5: Διὰ τὸ τὴν Ἀφροδίτην ὑπάρχειν ἐν Ζυγῶ καὶ τὴν Σελήνην ἐν Παρθένῳ ἀνατο<λικῆς> ἄμφω καὶ τὴν ἀπόρροιαν ἐκ τοῦ Ἡλίου τὴν Σελήνην σωματικῶς ποιείσ<θαι>, ἔσται τῆ μὲν κράσει ὁ γεννηθεὶς θερμότερος καὶ ὑγρότερος... .

Due to Aphrodite actually being in Libra and the Moon in Virgo, both emer<ging> and the Moon making its separation bodily from the Sun, the child will be warmer and wetter in his mixture [*i.e. temperament*]... .

(p. 225) VIII.1–2, ll. 2–4: <Τῆ>ν δὲ κτητικὴν τύχην ἐκ τοῦ τῆς τύχης κλήρου διαλαμβάνομεν καὶ ἐπειδὴ οὗτος ὑπὸ τε Κρόνου καὶ Ἀφροδίτης καὶ Ἑρμοῦ οἰκοδεσποτεῖται... .

We perceive the acquisitive ability of fortune from the [place of] the Lot of Fortune. And since this [place] is under the house-mastership of Kronos, Aphrodite and Hermes... .

(p. 228) XIV.3, l.11: ... κλήρος ἔρωτος Σκορπίου ς̄ λ̄ε. ...
... the Lot of Eros in Scorpio 6 35. ...

5. Chart in Olympiodorus, *Commentary on Paulus*, Ch. 22 (Boer, 59)
Appears to use Hermetic/Paulus formula for Lot of Eros

Boer, 59.8–15: ... κλήρος

Τύχης Αἰγοκέρωτος ιζ' Ἡλίου τριγωνοῦντος Ἑρμῆν Ἀφρο-
(10) δίτην, κλήρος Δαίμονος Διδύμων κβ' Διὸς ἑξαγωνοῦντος Ἡλίον,
τετραγωνοῦντος ... κλήρος Νίκης Κριοῦ κβ',
Ἡλίου τριγωνοῦντος ... κλήρος Ἐρωτος Διδύμων ιβ' Ἐρ-
-μοῦ τετραγωνοῦντος Ἀφροδίτην, κλήρος γάμου ἐπὶ Διὶ
Ἄρην τετραγωνοῦντι, κλήρος ξενιτείας Διδύμων μβ'
(15) Ἀφροδίτης ἢ Κρόνου ἑξαγωνοῦντος Ἄρην. [lacunae in text]

Lot of Fortune the 17th [degree] of Capricorn the Sun trining Hermes [and] Aphrodite,
Lot of Daimon the 22nd [degree] of Gemini Zeus sextiling the Sun, squaring ... Lot of
Victory the 22nd [degree] of Aries, Sun trining ... Lot of Eros 12th [degree] of Gemini
Hermes squaring Aphrodite, Lot of Marriage on Zeus squaring Ares, Lot of Living
Abroad the 13th¹ of Gemini Aphrodite or Kronos sextiling Ares.

6. Chart in Abū Ma'shar, *On the revolutions of nativities*, 3,1 (Pingree, 126–131)
Nocturnal chart

Uses Hermetic/Paulus formula for Lot of Intellect and Native Wit (a.k.a. Necessity)

Pingree, 126.24–129.3:

ἦν δὲ <ό>

[25] ὠροσκόπος ὁ Ταῦρος μοίραις β λεπτοῖς νδ, καὶ ἡ Σελήνη
ἐν αὐτῷ μοίραις ιβ λεπτοῖς μγ· ὁ δὲ Ἄρης ἐν τῷ Λέοντι
(128) μοίραις ι λεπτοῖς κθ, <ό δὲ> Ἡλίου ἐν Λέοντι μοίραις ιε
λεπτοῖς νζ, ὁ <δὲ> Ἑρμῆς ἐν τῷ Λέοντι μοίραις κβ λεπ-
τοῖς ζ ἀναποδίζων, <ἡ δὲ> Ἀφροδίτη ἐν Ζυγῷ μοίραις β
λεπτοῖς νδ, <ό δὲ> Ζεὺς <ἐν> Αἰγοκέρωτι μοίραις κ
(129) λεπτοῖς κς ἀναποδίζων, <ό δὲ> Κρόνος <ἐν> Ὑδροχόω
μοίραις κγ λεπτοῖς κς ἀναποδίζων, ὁ δὲ Ἀναβιβάζων <ἐν>
Παρθένω μοίραις κα λεπτοῖς κδ.

1 '13th' in ms. L; ms. A has '42nd'.

<The> Hour-marker was Taurus 2 degrees 54 minutes, and the Moon in the same [sign] 12 degrees 43 minutes; Ares in Leo 10 degrees 29 minutes, <the> Sun in Leo 15 degrees 57 minutes, Hermes in Leo 22 degrees 7 minutes retrograde, Aphrodite in Libra 2 degrees 54 minutes, Zeus <in> Capricorn 20 degrees 26 minutes retrograde, Kronos <in> Aquarius 23 degrees 26 minutes retrograde, the Ascending Node <in> Virgo 21 degrees 24 minutes.

130.1–131.14:

Εὐρον δὲ μεταξὺ τῆς ὠροσκοπούσης μοίρας καὶ τοῦ κλήρου τῆς ἀνδρείας μοίρας δ λεπτὰ κ, γινόμενα διὰ τῶν ἀναφορῶν τοῦ δ' κλίματος μοίρας γ λεπτὰ β. ἐπιμερίζει οὖν ἡ Ἀφροδίτη κατὰ τὰ ὅρια αὐτῆς ἔτη γ ἡμέρας ιβ· εἶτα [5] κολλᾷ ἡ μοῖρα τοῦ ὠροσκόπου τῷ κλήρῳ τῆς ἀνδρείας καὶ τῆς τόλμης, ἔτι καταλειπομένων τῇ Ἀφροδίτῃ ἐκ τῶν ὀρίων αὐτῆς λεπτῶν μς, γινομένων διὰ τῶν ἀναφορῶν λεπτῶν λβ καὶ ιβ δευτέρων λεπτῶν. καὶ διὰ τοῦτο εἵπομεν ὡς ἡ Ἀφροδίτη διέπει τῷ οἰκείῳ ἐπιμερισμῷ τὸν κλήρον [10] τῆς ἀνδρείας καὶ τῆς τόλμης μῆνας ς ἡμέρας ιγ· ὁμοῦ τὰ πάντα ἔτη γ μῆνες ἕξ ἡμέραι εἰκοσιπέντε ἔγγισ<τα>. Εἶτα καταντᾷ ὁ περίπατος εἰς τὰ ὅρια τοῦ Ἑρμοῦ, καὶ λαμβάνομεν τοῦτον ἐπιμερίζοντα· καὶ διοικεῖ τὸν κλήρον τῆς ἀνδρείας καὶ τῆς τόλμης ἔτος α καὶ ἡμέρας η ἔγγιστα. [15] καταλαμβάνει <δὲ> ὁ περίπατος ἐπὶ τὴν ἐξάγωνον ἀκτίνα τοῦ Κρόνου μετὰ ἔτη δ καὶ μῆνας ζ καὶ ἡμέρας γ ἔγγιστα, καὶ κυβερνᾷ ὁ Κρόνος διὰ τῆς ἐξαγωνικῆς αὐτοῦ ἀκτίνος ἐν τῷ ἐπιμερισμῷ τοῦ Ἑρμοῦ τὸν κλήρον τῆς ἀνδρείας καὶ τῆς τόλμης ἔτος ἕν μῆνας ι ἡμέρας ιζ ἔγγιστα. καὶ τότε [20] συναντᾷ ὁ κλήρος τῆς προκοπῆς καὶ τῆς νίκης ἦτοι μετὰ ἔτη ς καὶ μῆνας ς καὶ ἡμέρας κβ ἔγγιστα, καὶ κυβερνᾷ ὁ Κρόνος διὰ τῆς ἐξαγωνικῆς αὐτοῦ ἀκτίνος τοὺς δύο κλήρους, τὸν τε κλήρον τῆς ἀνδρείας καὶ τῆς τόλμης καὶ τὸν κλήρον τῆς προκοπῆς καὶ τῆς νίκης, σὺν καὶ τῷ ἐπιμερισμῷ τοῦ [25] Ἑρμοῦ, μῆνας ε ἡμέρας κθ, ὁμοῦ γινόμενα ἔτη ζ ἡμέρας κα ἔγγιστα. εἶτα παραλαμβάνει ἡ Σελήνη τὴν κυβέρνησιν σωματικῶς ἀπὸ τῆς ἐξαγωνικῆς ἀκτίνος τοῦ Κρόνου, καὶ διοικεῖ τοὺς β κλήρους τῷ οἰκείῳ σώματι καὶ τῷ ἐπιμερι- (131) σμῷ τοῦ Ἑρμοῦ μῆνας ια ἡμέρας ις· καὶ τελειοῦται ὁ ἐπιμερισμὸς τοῦ Ἑρμοῦ μετὰ ἔτη ζ μῆνας ια ἡμέρας κζ ἔγγιστα.

Εἶτα μεταβαίνει ὁ ἐπιμερισμὸς εἰς τὸν Δία, καὶ διοικεῖ
 [5] ἄμα τῇ Σελήνῃ τὸν κλῆρον τῆς ἀνδρείας καὶ τῆς τόλμης
 καὶ τὸν κλῆρον τῆς προκοπῆς καὶ τῆς νίκης μῆνας δ
 ἡμέρας κδ· καὶ καταντᾷ ὁ περίπατος εἰς τὸν κλῆρον τῆς
 φρονήσεως καὶ τῆς συνέσεως μετὰ ἕτη η μῆνας δ ἡμέρας
 κ καὶ α ἔγγιστα. εἶτα κυβερνᾷ ἡ Σελήνη σωματικῶς διὰ
 [10] τοῦ ἐπιμερισμοῦ τοῦ Διὸς τὸν κλῆρον τῆς φρονήσεως καὶ τῆς
 συνέσεως καὶ τοὺς δύο κλήρους τοὺς πρώτους ὧν ἐμνήσθη-
 μεν — λέγω δὴ τὸν κλῆρον τῆς ἀνδρείας καὶ τῆς τόλμης καὶ
 τὸν κλῆρον τῆς προκοπῆς καὶ τῆς νίκης — ἕτος ἓν μῆνας ς
 ἡμέρας η.

I found 4 degrees 20 minutes between the degree of the Hour-marker and the Lot of Bravery, which has come to be 3 degrees, 2 minutes due to the ascensions of the 4th zone (*klima*). And so Aphrodite distributes 3 years 12 days, according to her bounds; next [5] the degree of the Hour-marker contacts the Lot of Bravery and Courage, yet 46 minutes remain to Aphrodite from her bounds, which due to ascensions come to be 32 minutes and 12 seconds. And due to this we say that Aphrodite manages the Lot of [10] Bravery and Courage in her own distribution for 6 months 13 days. Altogether there are about 3 years, six months [and] twenty-five days.

Next the circumambulation comes to the bounds of Hermes, and we take this one as the distributor; and he manages the Lot of Bravery and Courage for about 1 year and 8 days. [15] <But> the circumambulation takes hold of the hexagonal ray of Kronos after about 4 years, 7 months and 3 days, and due to his hexagonal ray, Kronos governs the Lot of Bravery and Courage for about one year 10 months [and] 17 days in the distribution of Hermes. And then [20] the Lot of Advancement and Victory meets up with [it] after about 6 years, 6 months and 22 days, and due to his hexagonal ray Kronos governs the two lots, both the Lot of Bravery and Courage, and the Lot of Advancement and Victory, and with the distribution of [25] Hermes, for about 5 months [and] 29 days, altogether coming to about 7 years [and] 21 days. Next the Moon bodily takes over the governance from the hexagonal ray of Kronos, and administers the 2 lots with her own body and with the distribution (p. 131) of Hermes for 11 months, 16 days; and the distribution of Hermes is completed after about 7 years, 11 months, 27 days.

Next the distribution changes over to Zeus, and [5] together with the Moon he administers the Lots of Bravery and Courage, and Advancement and Victory for 4 months [and] 24 days; and the circumambulation comes to the Lot of Intellect and Native Wit after about 8 years, 4 months [and] 21 days. Next, [10] through the distribution of Zeus, the Moon governs bodily the Lot of Intellect and Native Wit, and the first two lots which we mentioned—I mean the Lot of Bravery and Courage and the Lot of Advancement and Victory—for one year, 6 months [and] 8 days.

Bibliography

Note: Works of unclear or legendary authorship (e.g. 'Hermetica' and 'Picatrix') are usually listed alphabetically by title, except in cases where the editor's name is widely known in association with the work (e.g. Diels and Kranz for *Die Fragmente der Vorsokratiker*). Egyptian, Mesopotamian, Gnostic and early Jewish works are listed under their modern editors, translators or commentators. For purposes of alphabetisation, definite and indefinite articles, prepositions and the prefix 'Pseudo' are ignored. Editions are listed before translations, without regard for alphabetisation.

1 Manuscripts

Laurentianus Pluteus, 28, 34. Florence: Bibliotheca Medicea Laurenziana.
Oxoniensis Seldenianus 22 (Seld. Arch B 19). Oxford: Bodleian Library
Parisinus graecus 2506. Paris: Bibliothèque nationale de France
Vaticanus graecus 1056. Vatican: Vatican Library

2 Primary Sources

Abry, Josèphe-Henriette, ed. *Les tablettes astrologiques de Grand (Vosges) et l'astrologie en Gaule Romaine. Actes de la Table-Ronde du 18 mars 1992 organisée au Centre d'Études Romaines et Gallo-Romaines de l'Université Lyon III, Collection du Centre d'Études Romaines et Gallo-Romaines*. Nouvelle série no. 12. Lyon: Centre d'Études Romaines et Gallo-Romaines, 1993.

Abt, A. 'Ein Bruchstück einer Sarapis-Aretalogie'. *ArchRW* 18 (1915): 256–68.

Abū Ma'shar. *The Abbreviation of the Introduction to Astrology: together with the medieval Latin translation of Adelard of Bath*. Edited and translated by Charles Burnett, Keiji Yamamoto and Michio Yano. Leiden/New York: E. J. Brill, 1994.

———. *The Abbreviation of the Introduction to Astrology*. Translated by Charles Burnett, annotations by Charles Burnett, Graeme Tobyn, Geoffrey Cornelius and Vernon Wells. Reston, VA: ARHAT, 1997.

———. *Abū Ma'shar: Great Introduction to Astrology*. Edited by Keiji Yamamoto, translation and commentary by Keiji Yamamoto and Charles Burnett. Leiden/Boston: Brill, forthcoming.

———. *De revolutionibus nativitatum*. Edited by David Pingree. Leipzig: B. G. Teubner, 1968.

- . al-Balkhi. *Liber introductorii maioris ad scientiam iudiciorum astrorum*. Edited by Richard Lemay. 9 vols. Vol. v. Naples: Istituto universitario orientale, 1995.
- Achilles. *Isagoga*. In *Commentariorum in Aratum reliquiae*, 25–75. Edited by Ernst Maass. Berlin: Weidmann, 1898.
- Aeschylus. *Prometheus vincetus*. In *Aeschyli Septem Quae Supersunt Tragoedias*. Edited by D. L. Page. Oxford: Clarendon Press, 1972.
- . *Prometheus Bound*. Translated by Herbert Weir Smyth. Cambridge, MA: Harvard University Press, 1926.
- al-Bīrūnī. *The Book of Instruction in the Elements of the Art of Astrology*. Translated by R. Ramsay Wright. London: Luzac & Co., 1934.
- Alexander of Aphrodisias. *On Fate*. Edited and translated by Robert W. Sharples. London: Duckworth, 1983.
- Al-Qabīṣī. *The Introduction to Astrology*. Edited and translated by Charles Burnett, Keiji Yamamoto and Michio Yano. London/Turin: The Warburg Institute—Nino Aragno Editore, 2004.
- Antiochus of Athens. *Thesaurus*. In *CCAG* I, 140–64 and *CCAG* VII, 107–28. Edited by Franz Boll. Brussels: Henri Lamertin, 1898, 1908.
- . *Introduction: Summaries of Books 1 and 2*. In *CCAG* VIII/3, 111–118. Edited by Franz Cumont. Brussels: Henri Lamertin, 1912.
- Anubio. *Anoubion, Elegiacs*. Edited and translated by Dirk Obbink. Vol. LXVI, The Oxyrhynchus Papyri. London: Egypt Exploration Society, 1999.
- . *Carmen Astrologicum Elegiacum*. Edited by Dirk Obbink. Munich/Leipzig: K. G. Saur, 2006.
- Apuleius. *Apuleius of Madauros, The Isis-Book (Metamorphoses, Book XI)*. Edited, translated and commentary by J. Gwyn Griffiths. Leiden: E. J. Brill, 1975.
- . *De philosophia libri*. Edited by Claudio Moreschini. Opera quae supersunt, vol. 3. Stuttgart/Leipzig: B. G. Teubner, 1991.
- . *Metamorphoseon Libri XI*. Edited by Rudolf Helm. Opera quae supersunt, vol. 1. Leipzig: B. G. Teubner, 1955.
- . *Metamorphoses*. Edited and translated by J. Arthur Hanson. 2 vols. Cambridge, MA/London: Harvard University Press, 1989.
- . *Rhetorical works*. Translated by Stephen Harrison, John Hilton and Vincent Hunink. Edited by S. J. Harrison. Oxford/New York: Oxford University Press, 2001.
- Aratus. *Phaenomena*. Edited, translated and commentary by Douglas Kidd. Cambridge: Cambridge University Press, 1997.
- Aristophanes. *Aves*. Translated by Hilaire van Daele. In *Aristophane*, Tome III. Edited by Victor Coulon. Paris: Les Belles Lettres, 1928, repr. 1967.
- Aristotle. *Analytica priora et posteriora*. Edited by William David Ross. Oxford: Clarendon Press, 1964, repr. 1968.

- . *The Athenian Constitution; Eudemian Ethics; On Virtues and Vices*. Translated by Harris Rackham. Loeb Classical Library. Cambridge, MA: Harvard University Press, 1935.
- . *Nichomachean Ethics*. Translated by Harris Rackham. Loeb Classical Library. Cambridge, MA: Harvard University Press, 1934.
- Artemidorus. *Oneirocritica*. Edited by Roger A. Pack. Leipzig: B. G. Teubner, 1963.
- . *The Interpretation of Dreams*. Translated and commentary by Robert J. White. Park Ridge, NJ: Noyes Press, 1975.
- Ashton, Sally-Ann. *Roman Egyptomania*. London: Golden House Publications, 2004.
- Athenagoras. *Legatio pro Christianis*. Edited by Miroslav Marcovich. Berlin/New York: De Gruyter, 1990.
- Baccani, Donata. *Oroscoli greci: documentazione papirologica*. Vol. 1, Ricerca papirologica. Messina: Sicania, 1992.
- Bacchylides et al. *Bacchylides, Corinna and Others*. In *Greek Lyric*, IV. Edited and translated by David A. Campbell. Loeb Classical Library. Cambridge, MA: Harvard University Press, 1992.
- Bernard, Étienne. *Inscriptions métriques de l'Égypte gréco-romaine. Recherches sur la poésie épigrammatique des grecs en Égypte*. Vol. 98, Annales littéraires de l'Université de Besançon. Paris: Les Belles Lettres, 1969.
- Betz, Hans Dieter, ed. *The Greek Magical Papyri in Translation, including the Demotic Spells*. Vol. 1, *Texts*. Chicago/London: University of Chicago Press, 1986, 2nd. ed. 1992, repr. 1996.
- The Bible. The Holy Bible containing the Old and New Testaments, translated out of the original tongues: and with the former translations diligently compared and revised by his Majesty's special command, appointed to be read in churches*. King James (Authorised) Version. Oxford: University Press, ca. 1930.
- . *Novum Testamentum graecae*. Edited by Philipp Buttmann. Leipzig: B. G. Teubner, 1910.
- Black, Matthew. *The Book of Enoch or I Enoch: A New English Edition*. Appendix by Otto Neugebauer. Vol. 7, *Studia in veteris testamenti pseudepigrapha*. Leiden: E. J. Brill, 1985.
- Blenkinsopp, Joseph. *Isaiah 56–66: A New Translation with Introduction and Commentary*. Vol. 19B, *The Anchor Bible*. New York/London: Doubleday, 2003.
- Boll, Franz. *Griechische Kalender I. Das Kalendarium des Antiochus*. Heidelberg: Carl Winter's Universitätsbuchhandlung, 1910.
- von Bomhard, Anne-Sophie. *The Naos of the Decades: From the Observation of the Sky to Mythology and Astrology*. Translated by Ludwig von Bomhard. Monograph 3, Oxford Centre for Maritime Archaeology. Oxford: Institute of Archaeology, University of Oxford, 2008.

- Bonatti, Guido. *De astronomia tractatus X*. Basle: n.p., 1550.
- Bonner, Campbell. 'An Amulet of the Ophite Gnostics'. *Hesperia Supplements* 8 (1949): 43–46; 444.
- . *Studies in Magical Amulets, chiefly Graeco-Egyptian*. Ann Arbor: University of Michigan Press, 1950.
- Borghouts, J. F. *Ancient Egyptian Magical Texts*. Vol. 9, Nisaba. Leiden: Brill, 1978.
- Brugsch, Heinrich. *Astronomische und astrologische Inschriften der altaegyptischer Denkmäler*. In *Thesaurus inscriptionum aegyptiacarum*, Pt. 1. Leipzig: J. C. Hinrichs'sche Buchhandlung, 1883.
- Burstein, Stanley M., ed. and trans. *The Hellenistic age from the battle of Ipsos to the death of Kleopatra VII*. Cambridge: Cambridge University Press, 1985.
- Busch, Peter. *Das Testament Salomos. Die älteste christliche Dämonologie, kommentiert und in deutscher Erstübersetzung*. Berlin/New York: Walter de Gruyter, 2006.
- (Pseudo-)Callisthenes. *Historia Alexandri Magni*. Edited by Wilhelm Kroll. Berlin: Weidmann, 1926.
- . *The Greek Alexander Romance*. Translated and annotated by Richard Stoneman. London: Penguin Books, 1991.
- . *The Romance of Alexander the Great*. Translated by A. M. Wolohojian. New York/London: Columbia University Press, 1969.
- Catullus, Gaius Valerius. *Carmina*. Edited by R. A. B. Mynors. Oxford: Oxford University Press, 1958.
- Censorinus. *De die natali liber ad Q. Caerellium*. Edited by Nicolaus Sallmann. Bibliotheca scriptorum Graecorum et Romanorum Teubneriana. Leipzig: Teubner, 1983.
- . *Censorinus: The Birthday Book*. Translated by Holt N. Parker. Chicago/London: University of Chicago Press, 2007.
- Černý, Jaroslav, P. E. Kahle, and R. A. Parker. 'The Old Coptic Horoscope'. *JEA* 43 (1957): 86–100.
- Chaeremon of Alexandria. *Chaeremon: Egyptian Priest and Stoic Philosopher. The fragments collected and translated with explanatory notes*. Edited by Pieter Willem van der Horst. Leiden: E. J. Brill, 1987.
- Charlesworth, James H. *The Old Testament Pseudepigrapha*. Vol. 1, *Apocalyptic Literature and Testaments*. London: Darton, Longman & Todd, 1983.
- Cicero, Marcus Tullius. *Aratea. Fragments poétiques*. Edited and translated by Jean Soubiran. Collection des universités de France. Paris: Les Belles Lettres, 1972.
- . *De natura deorum*. Translated by Harris Rackham. In *Cicero XIX. De natura deorum; Academica*. Loeb Classical Library. London/New York: William Heinemann, 1933.
- . *De senectute. De amicitia. De divinatione*. Translated by W. A. Falconer. Loeb Classical Library. Cambridge, MA: Harvard University Press, 1923, repr. 2001.

- Clagett, Marshall. *Ancient Egyptian Science: A Source Book*. 3 vols. Vol. 2. Philadelphia: American Philosophical Society, 1995.
- Cooke, G. A. *A Text-Book of North-Semitic Inscriptions: Moabite, Hebrew, Phoenecian, Aramaic, Nabataean, Palmyrene, Jewish*. Oxford: Clarendon Press, 1903.
- Cornutus, Lucius Annaeus. *Theologiae Graecae compendium*. Edited by Carolus Lang. Leipzig: Teubner, 1881.
- Corpus Hermeticum*. Edited by A. D. Nock, Translated by A.-J. Festugière. 4 vols. I–IV (III and IV ed. and trans. A.-J. Festugière). Paris: Les Belles Lettres, 1945–1954.
- Dalley, Stephanie. *Myths from Mesopotamia: Creation, the Flood, Gilgamesh, and Others*. Oxford: Oxford University Press, 1989, repr. 1991.
- Damascius. *Dubitationes et solutiones de primis principiis*. Edited by Charles Émile Ruelle. 2 vols. Paris: C. Klincksieck, 1889, repr. 1964.
- . *Traité des premiers principes*. Edited by L. G. Westerink, Translated by Joseph Combès. Paris: Les Belles Lettres, 1991.
- Daniel, Robert W., ed. *Two Greek Magical Papyri in the National Museum of Antiquities in Leiden. A Photographic Edition of J 384 and J 395 (= PGM XII and XIII)*. Papyrologica Coloniensia. Opladen: Westdeutscher Verlag, 1991.
- Dattari, G. *Numi Augg. Alexandrini. Catalogo della collezione G. Dattari*. 2 vols. Cairo: Tipographia dell'instituto francese d'archeologia orientale, 1901.
- de Jong, Teije, and Klaas A. Worp. 'A Greek Horoscope from 373 AD' *ZPE* 106 (1995): 235–40.
- . 'More Greek Horoscopes from Kellis (Dakhleh Oasis)'. *ZPE* 137 (2001): 203–14.
- Diels, Hermann, and Walther Kranz. *Die Fragmente der Vorsokratiker: griechisch und deutsch*. 6th ed. 3 vols. Vol. 1. Berlin: Weidmann, 1951, repr. 1966.
- Dio Cassius. *Roman History*. 9 vols. Translated by Earnest Cary. Loeb Classical Library. Cambridge, MA: Harvard University Press, 1914–1927.
- Diodorus Siculus. *Bibliotheca historica*, vol. 1. Translated by C. H. Oldfather. Loeb Classical Library. London/New York: Harvard University Press, 1933.
- Diogenes Laertius. *Vitae philosophorum*. Edited by Miroslav Marcovich. 3 vols. Munich/Leipzig: K. G. Saur, 1999–2002.
- Dorotheus of Sidon. *Carmen Astrologicum*. Edited by David Pingree. Leipzig: B. G. Teubner, 1976.
- Eliot, George. *The Mill on the Floss*. Copyright Edition. Leipzig: B. Tauchnitz, 1860.
- Empedocles. *Empedocles: The Extant Fragments*. Edited and translated by M. R. Wright. New Haven/London: Yale University Press, 1981.
- Epictetus, *Manual*. Translated by P. E. Matheson. In Whitney J. Oates, ed. *The Stoic and Epicurean Philosophers: The Complete Extant Writings of Epicurus, Epictetus, Lucretius, Marcus Aurelius*. New York: Random House, 1940.
- Farber, Walter. *Schlaf, Kindchen, Schlaf! Mesopotamische Baby-Beschwörungen und -Rituale*. Mesopotamian Civilizations. Winona Lake, IN: Eisenbrauns, 1989.

- Faulkner, Raymond O., and Ogden Goelet, Jr. *The Egyptian Book of the Dead: The Book of Going Forth by Day*. San Francisco: Chronicle Books, 1994.
- Ficino, Marsilio. *Three Books on Life*. Edited by Carol V. Kaske and John R. Clark. Tempe, AZ: Medieval and Renaissance Texts and Studies/The Renaissance Society of America, 1998.
- Figulla, H. H., E. Forrer, and E. F. Weidner, eds. *Keilinschrifttexte aus Boghazköi*. Vol. 1–iv. Leipzig: J. C. Hinrichs'sche Buchhandlung, 1923.
- Firmicus Maternus, Julius. *Matheseos libri VIII*. Edited by Wilhelm Kroll, Franz Skutsch and Konrat Ziegler. 2 vols. Leipzig: B. G. Teubner, 1897–1913.
- . *Mathesis*. Edited and translated by P. Monat. 3 vols. Collection des universités de France. Paris: Les Belles Lettres, 1992–1997.
- . *Ancient Astrology: Theory and Practice, Matheseos Libri VIII by Firmicus Maternus*. Translated by Jean Rhys Bram. Park Ridge, New Jersey: Noyes Press, 1975. Reprint, Mansfield, Notts: Ascella, 1995.
- Forenbaher, Stašo, and Alexander Jones. 'The Nakovana Zodiac: Fragments of an Astrologer's Board from an Illyrian-Hellenistic Cave Sanctuary'. *JHA* 42 (2011): 425–38.
- Freeman, Kathleen. *Ancilla to the Pre-Socratic Philosophers*. Oxford: Basil Blackwell, 1948.
- Freud, Sigmund. *Civilization and its Discontents*. Translated by Joan Rivière. In vol. 21, *Complete Psychological Works of Sigmund Freud*. Edited by James Strachey. London: The Hogarth Press and the Institute of Psychoanalysis, 1961, repr. 1973.
- . 'The Dynamics of Transference'. In *The Standard Edition of the Complete Psychological Works of Sigmund Freud*, vol. xii. Edited by James Strachey, et al., 97–108. London: The Hogarth Press, 1958, repr. 1981.
- . 'Zur Dynamik der Übertragung'. In *Gesammelte Werke*, Band 8. Edited by Anna Freud et al. London: Imago Publishing Company, 1943, repr. 1948.
- . *Das Unbehagen in der Kultur*. Vienna: Internationaler Psychoanalytischer Verlag, 1930.
- Das Geheimniss der Hermetischen Philosophie, in welchem die Verborgenheit der Natur und der Kunst, die Materie und Weise zu wirken betreffende, vom Steine der Weisen, durch gewisse Regeln ordentlich geoffenbaret wird. Aus der dritten vermehrten und verbesserten Lateinischen Ausfertigung Parisischen Drucks ins Hochdeutsche übersetzt*. Frankfurt and Leipzig: In der Fleischerischen Buchhandlung, 1770.
- Galen, Claudius. *De consuetudinibus*. In *Scripta Minora*. Edited by Johann Marquardt, Iwan Müller and Georg Helmreich. Leipzig: Teubner, 1891.
- . *De usu partium*. In *Opera Omnia*, vol. III. Edited by C. G. Kühn. Hildesheim: Georg Olms, 1964.
- . *Opera Omnia*. Edited by C. G. Kühn. Vol. III. Hildesheim: Georg Olms, 1964–65.

- . *Opera Omnia*. Edited by C. G. Kühn. Vol. XI. Hildesheim: Georg Olms, 1964–5.
- Gardiner, Alan H. *Late-Egyptian Stories*. Vol. 1, Bibliotheca Aegyptiaca. Brussels: Édition de la Fondation égyptologique Reine Élisabeth, 1932.
- Geller, Markham J. *Evil Demons: Canonical Utukkū Lemnūtu Incantations*. Vol. 5, SAACT. Helsinki: Neo-Assyrian Text Corpus Project, 2007.
- . *Forerunners to Udug-hul: Sumerian Exorcistic Incantations*. Vol. 12, Freiburger altorientalische Studien. Stuttgart: Franz Steiner Verlag Wiesbaden GMBH, 1985.
- Geminus. *Introduction aux phénomènes*. Edited and translated by Germaine Aujac. Paris: Les Belles Lettres, 1975.
- Grandjean, Yves. *Une nouvelle aréologie d'Isis à Maronée*. Vol. 49, Études préliminaires aux religions orientales dans l'Empire romain. Leiden: E. J. Brill, 1975.
- Greene, William Chase, ed. *Scholia Platonica*. Edited by Frederic D. Allen, John Burnet and Charles Pomeroy Parker. Haverford, PA: American Philological Association, 1938.
- Grenfell, Bernard P., and Arthur S. Hunt. *The Oxyrhynchus Papyri. Part III*. Egypt Exploration Fund, Graeco-Roman Branch. London: Kegan Paul, 1903.
- Griffith, F. Llewellyn, and Herbert Thompson. *The Demotic Magical Papyrus of London and Leiden*. 2 vols. London: H. Grevel and Co., 1904–1905, repr. Milan: Cisalpino—La Goliardica, 1976.
- Griffith, F. Llewellyn, and Herbert Thompson, eds. *The Leyden Papyrus: An Egyptian Magical Book*. New York: Dover Publications, 1904, repr. 1974.
- Gundel, Hans Georg. *Zodiakos. Tierkreisbilder im Altertum. Kosmische Bezüge und Jenseitsvorstellungen im antiken Alltagsleben*. Vol. 54, Kulturgeschichte der antiken Welt. Mainz am Rhein: Verlag Philipp von Zabern, 1992.
- Heilen, Stephan. *Hadriani genitura. Die astrologischen Fragmente des Antigonos von Nikaia. Edition, Übersetzung und Kommentar*. Vol. 43, Texte und Kommentare. Berlin: De Gruyter, in press.
- Hephaestio. *Hephaestio Thebanus. Apotelesmaticorum libri tres*. Edited by David Pingree. 2 vols. Leipzig: B. G. Teubner, 1973.
- Heraclitus. *Heraclitus*. Translated by Philip Wheelwright. Princeton: Princeton University Press, 1959.
- Hermetica*. Translated and commentary by Brian P. Copenhaver. Cambridge: Cambridge University Press, 1992, repr. 2000.
- Hermetica: The Ancient Greek and Latin Writings which Contain Religious or Philosophic Teachings Ascribed to Hermes Trismegistus*. Edited and translated by Walter Scott. 4 vols. Oxford: Clarendon Press, 1926.
- Herodotus. *Historiae*. Edited by Haiim B. Rosén. 2 vols. Leipzig: B. G. Teubner, 1987.
- . *Histories*. Translated by A. D. Godley. 4 vols. Loeb Classical Library. London/New York: Heinemann/G. P. Putnam's Sons, 1921–1924.

- . *The Histories of Herodotus of Halicarnassus*. Translated by Harry Carter. London: Oxford University Press, 1962.
- Herrick, Robert. *The Poetical Works of Robert Herrick*. Edited by L. C. Martin. Oxford: Clarendon Press, 1956.
- Hesiod. *Theogony, with prolegomena and commentary*. Edited by M. L. West. Oxford: Clarendon Press, 1966, repr. 1997.
- . *Theogony*. Translated by Hugh G. Evelyn-White. In *Hesiod; Homeric Hymns; Epic Cycle; Homeric*. Loeb Classical Library. Cambridge, MA: Harvard University Press, 1914, repr. 1995.
- . *Works and Days*. Translated by Hugh G. Evelyn-White. In *Hesiod, Homeric Hymns, Epic Cycle, Homeric*. Loeb Classical Library. Cambridge, MA: Harvard University Press, 1914, repr. 1995.
- Hipparchus. *Hipparchi in Arati et Eudoxi phaenomena commentariorum libri tres*. Edited and translated by Karl Manitius. Leipzig: Teubner, 1894.
- Homer. *Ilias*. Edited by Thomas W. Allen. Vols 2–3. Oxford: Clarendon Press, 1931.
- . *Odyssea*. Edited by Arthur Ludwich. Stuttgart/Leipzig: B. G. Teubner, 1889, repr. 1998.
- The Homeric Hymns*. Translated and annotated by Apostolos N. Athanassakis. Baltimore: Johns Hopkins University Press, 1976.
- Hübner, Wolfgang. *Grade und Gradbezirke der Tierkreiszeichen*. 2 vols. Vol. 1, Edition, vol. 11, Kommentar. Stuttgart/Leipzig: B. G. Teubner, 1995.
- Hughes, George R. 'An Astrologer's Handbook in Demotic Egyptian'. In *Egyptological Studies in Honor of Richard A. Parker*, edited by Leonard H. Lesko, 53–69. Hanover, NH: University Press of New England, 1986.
- . 'A Demotic Astrological Text'. *JNES* 10, no. 4 (1951): 256–64.
- . 'A Demotic Plea to Thoth in the Library of G. Michaelides'. *JEA* 54 (1968): 176–82.
- Hugo of Santalla. *The Liber Aristotilis of Hugo of Santalla*. Edited by Charles Burnett and David Pingree. London: The Warburg Institute, 1997.
- Hunger, Hermann. *Astrological Reports to Assyrian Kings*. Vol. 8, State Archives of Assyria. Helsinki: Helsinki University Press, 1992.
- Hyginus. *De astronomia*. Edited by Ghislaine Viré. Stuttgart/Leipzig: Teubner, 1992.
- Iamblichus. *Iamblichus Chalcidensis ex Coele-Syria, De mysteriis liber Præmittitur epistola Porphyrii ad Anebonem Ægyptium, eodem argumento*. Edited by Thomas Gale. Oxford: E teatro Sheldoniano, 1678.
- . *Iamblichus on The Mysteries of the Egyptians, Chaldeans and Assyrians*. Translated by Thomas Taylor. London: Stuart and Watkins, 1821, repr. 1968.
- . *Les mystères d'Égypte*. Edited and translated by Édouard Des Places. Paris: Les Belles Lettres, 1989.
- . *On The Mysteries*. Edited, translation and commentary by Emma C. Clarke, John M. Dillon and Jackson P. Hershbell. Vol. 4, Writings from the Greco-Roman World. Atlanta: Society of Biblical Literature, 2003.

- . *In Platonis dialogos commentariorum fragmenta*. Edited by John Dillon. Leiden: Brill, 1973.
- Ibn Ezra, Abraham. *Abraham Ibn Ezra: The Book of Reasons. A Parallel Hebrew-English Critical Edition of the Two Versions of the Text*. Edited and translated by Shlomo Sela. Leiden/Boston: Brill, 2007.
- . *The Beginning of Wisdom (Reshit Hochma)*. Translated by Meira B. Epstein. Edited by Robert Hand. Reston, VA: ARHAT, 1998.
- . *The Beginning of Wisdom: An Astrological Treatise*. Edited by Raphael Levy and Francisco Cantera. Translated by Raphael Levy. Baltimore, MD: The Johns Hopkins Press, 1939.
- . *The Book of Reasons (Sefer Ha'te'amim)*. Translated by Meira B. Epstein. Edited by Robert Hand. Berkeley Springs, WV: Golden Hind Press, 1994.
- Irenaeus. *Contre les hérésies, Livre I*. Edited by Adelin Rousseau and Louis Doutreleau. 2 vols. Vol. 263, Sources chrétiennes. Paris: Editions du Cerf, 1979.
- Isaeus. *Isaeus*. Translated by Edward Seymour Forster. Loeb Classical Library. Cambridge, MA: Harvard University Press, 1927.
- Jenott, Lance. *The Gospel of Judas: Coptic Text, Translation, and Historical Interpretation of the 'Betrayal' Gospel*. Vol. 64, Studien und Texte zu Antike und Christentum. Tübingen: Mohr Siebeck, 2011.
- Jones, Alexander, ed., trans. and comm. *Astronomical Papyrus from Oxyrhynchus*. 2 vols. Philadelphia: American Philosophical Society, 1999.
- . 'The Keskinos Astronomical Inscription: Text and Interpretation'. *Sciamus* 7 (2006): 3–41.
- Julian. *Chaldean Oracles: Text, Translation, Commentary*. Edited by Ruth Dorothy Majercik. Leiden/New York: Brill, 1989.
- Julian the Emperor. *Oration to the Sun*. Translated by Wilmer Cave Wright. In *The Works of the Emperor Julian*, vol. 1. Loeb Classical Library. London/New York: William Heinemann/Macmillan, 1913.
- Jung, Carl Gustav. *The Collected Works of C. G. Jung*, vol 8. Translated by R. F. C. Hull. London: Routledge & Kegan Paul, 1960.
- . *Memories, Dreams, Reflections*. Translated by Richard and Clara Winston. Edited by Aniela Jaffe. New York: Vintage Books, 1961, repr. 1989.
- . *Synchronicity—An Acausal Connecting Principle*. Translated by R. F. C. Hull. London: Routledge & Kegan Paul, 1972.
- Kaizer, T. 'De Dea Syria et aliis diis deabusque (Part 1)'. *OLP* 98 (1997): 147–66.
- Kalbfleisch, K. 'Die neuplatonische, fälschlich dem Galen zugeschriebene Schrift Πρὸς Γαῦρον περὶ τοῦ πῶς ἐμψυχοῦνται τὰ ἔμβρυα'. In *Abhandlungen der königlichen Akademie der Wissenschaften zu Berlin: Philosophische und historische Abhandlungen*, 1–83. Berlin: Verlag der königlichen Akademie der Wissenschaften, 1895.
- Kasser, Rodolphe, Marvin Meyer, and Gregor Wurst, eds. *The Gospel of Judas from Codex Tchacos*. Washington, D.C.: National Geographic Society, 2006.

- , eds. *The Gospel of Judas, Second Edition*. Washington, D. C.: National Geographic Society, 2008.
- Kasser, Rodolphe, and Gregor Wurst, eds. *The Gospel of Judas together with the Letter of Peter to Philip, James, and a Book of Allogenes from Codex Tchacos: Critical Edition*. Washington, D. C.: National Geographic Society, 2007.
- Kerkeslager, Allen. 'The Apology of the Potter: A Translation of the Potter's Oracle'. In *Jerusalem studies in Egyptology*, edited by Irene Shirun-Grumach, 67–79. Wiesbaden: Harrassowitz, 1998.
- Kern, Otto. *Orphicorum fragmenta*. Berlin: Weidmann, 1922.
- Kitchen, K. A. *Rameside Inscriptions, Historical and Biographical*. Vol. II. Oxford: Basil Blackwell Ltd., 1979.
- . *Rameside Inscriptions, Historical and Biographical*. Vol. VI. Oxford: Basil Blackwell Ltd., 1983.
- Klutz, Todd E., trans. 'The Eighth Book of Moses'. In *Old Testament Pseudepigrapha: More Noncanonical Scriptures*, edited by Richard Bauckham, James R. Davila and Alexander Panayotov. Vol. 1. Grand Rapids, MI: Wm. B. Eerdmans Publishing Co., 2013.
- Kockelmann, Holger. *Praising the Goddess: A Comparative and Annotated Re-Edition of Six Demotic Hymns and Praises Addressed to Isis*. Vol. 15, *Archiv für Papyrusforschung und verwandte Gebiete*. Berlin/New York: Walter De Gruyter, 2008.
- Koenen, Ludwig. 'Die Prophezeiungen des "Töpfers"'. *ZPE* 2 (1968): 178–209.
- Kosmopoulou, Angeliki. *The Iconography of Sculptured Statue Bases in the Archaic and Classical Periods*. Madison, WI: University of Wisconsin Press, 2002.
- Layton, Bentley, ed. *Nag Hammadi Codex II, 2–7, together with XIII,2*, Brit. Lib. Or. 4926(1) and P. Oxy. 1, 654, 655 with contributions by many scholars*. 2 vols. Vol. 2, *Nag Hammadi Studies*. Leiden/New York/Copenhagen/Cologne: E. J. Brill, 1989.
- Lexicon Iconographicum Mythologiae Classicae*. 8 double vols. Zurich/Munich: Artemis Verlag, 1981–1999.
- (Pseudo-)Libanius. *Progymnasmata: Descriptiones*. In *Libanii Opera*, vol. VIII, 438–546. Edited by Richard Foerster. Leipzig: B. G. Teubner, 1915.
- Liber Hermetis*. In Gundel, Wilhelm. *Neue astrologische Texte des Hermes Trismegistos. Funde und Forschungen auf dem Gebiet der antiken Astronomie und Astrologie*. Munich: Verlag der Bayerischen Akademie der Wissenschaften, 1936.
- Liber Hermetis*. In *Hermetis Trismegisti. De Triginta Sex Decanis*. Edited by Simonetta Feraboli. *Hermes Latinus* Tome IV, Part 1 (Corpus Christianorum). Turnhout: Brepols, 1994.
- Lichtheim, Miriam. *Ancient Egyptian Literature: A Book of Readings*. Vol. I: *The Old and Middle Kingdom*. Berkeley/Los Angeles/London: University of California Press, 1973.
- . *Ancient Egyptian Literature: A Book of Readings*. Vol. II: *The New Kingdom*. Berkeley/Los Angeles/London: University of California Press, 1976.

- . *Ancient Egyptian Literature: A Book of Readings*. Vol. III: *The Late Period*. Berkeley/Los Angeles/London: University of California Press, 1980.
- von Lieven, Alexandra. *Grundriss des Laufes der Sterne. Das sogenannte Nutbuch*. Vol. 1, *Text*. Vol. 31, Carsten Niebuhr Institute Publications. The Carlsberg Papyri 8. Copenhagen: Museum Tusulanum Press, 2007.
- Lilly, William. *Christian Astrology*. London: Tho. Brudenell, 1647, repr. Exeter: Regulus, 1985.
- Lopilato, Robert. "The 'Apotelesmatika' of Manetho". Ph.D. Thesis, Brown University, 1998.
- Macrobius, Ambrosius Theodosius. *Commentarii in somnium Scipionis*. 2nd ed. Edited by James Willis. Macrobius, vol. 2. Stuttgart: B. G. Teubner, 1994.
- . *Macrobius. Commentary on the Dream of Scipio*. Translated and annotated by William Harris Stahl. New York: Columbia University Press, 1952.
- . *Saturnalia*. 2nd ed. Edited by James Willis. Macrobius, vol. 1. Stuttgart/Leipzig: B. G. Teubner, 1994.
- . *The Saturnalia*. Translated and annotated by Percival Vaughan Davies. New York: Columbia University Press, 1969.
- Manilius, Marcus. *Astronomica*. Edited by George P. Goold. Leipzig: B. G. Teubner, 1985.
- . *Astronomica*. Edited and translated by George P. Goold. Loeb Classical Library. Cambridge, MA/London: Harvard University Press, 1977, repr. 1997.
- . *Il poema degli astri (Astronomica)*. Edited by Enrico Flores, translation and commentary by Riccardo Scarcia, commentary by Simonetta Feraboli. 2 vols. Milan: Fondazione Lorenzo Valla, Arnoldo Mondadori Editore, 1996, 2001.
- . *M. Manilio Astronomica libro terzo*. Edited, translated and commentary by Dora Liuzzi. Lecce: Milella Editore, 1988.
- . *Astronomicon. Liber Secundus*. Edited by A. E. Housman. London: Grant Richards, 1912.
- Martianus Capella. *De nuptiis Philologiae et Mercurii*. Edited by Adolf Dick, with additions and corrections by Jean Préaux. Stuttgart: B. G. Teubner, 1969.
- . *De nuptiis Philologiae et Mercurii*. Edited by James Willis. Leipzig: B. G. Teubner, 1983.
- . *Martianus Capella and the Seven Liberal Arts*. Translated and annotated by William Harris Stahl, Richard Johnson and E. L. Burge. 2 vols. Vol. 2, *The Marriage of Philology and Mercury*. New York: Columbia University Press, 1977.
- Maximus of Tyre. *The Philosophical Orations*. Translated and annotated by Michael B. Trapp. Oxford: Clarendon Press, 1997.
- McCown, Chester Charlton. *The Testament of Solomon, edited from Manuscripts at Mount Athos, Bologna, Holkham Hall, Jerusalem, London, Milan, Paris and Vienna*. Leipzig: J. C. Hinrichs, 1922.
- McKenzie, Judith S., Joseph A. Greene, Andres T. Reyes, Catherine S. Alexander, Deirdre G. Barrett, Brian Gilmour, John F. Healey, Margaret O'Hea, Nadine Schibille,

- Stephan G. Schmid, Wilma Wetterstrom, and Sarah Witcher Kansa. *The Nabataean Temple at Khirbet et-Tannur, Jordan: Final Report on Nelson Glueck's 1937 Excavation*. 2 vols. Vol. 67–68, Annual of the American Schools of Oriental Research. Boston: American Schools of Oriental Research, 2013.
- Meyer, Marvin, ed. *The Nag Hammadi Scriptures: The International Edition*. New York: HarperCollins, 2007.
- Milne, J. G. *A Catalogue of Alexandrian Coins in the Ashmolean Museum*. Oxford: Oxford University Press, 1933.
- Miscall, Peter D. *Isaiah*. Sheffield: JSOT Press (Sheffield Academic Press), 1993.
- Mitropoulou, Elpis. *Deities and Heroes in the Form of Snakes*. Athens: Pyli Editions, 1977.
- Nechepso, and Petosiris. *Fragmenta magica*. Edited by E. Riess. In *Philologus*, Suppl. Bd. 6, pt. 1. Göttingen, 1892.
- Nemesius. *De natura hominis*. Edited by Moreno Morani. Leipzig: B. G. Teubner, 1987.
- Nenna, Marie-Dominique. 'De Douch (oasis de Kharga) à Grand (Vosges): un disque en verre peint à représentations astrologiques'. *BIFAO* 103 (2003): 355–75.
- Neoplatonic Saints: The Lives of Plotinus and Proclus by their Students*. Translated by Mark Edwards. Vol. 35, Translated Texts for Historians. Liverpool: Liverpool University Press, 2000.
- Nesselrath, Heinz-Günther, ed. *Plutarch On the daimonion of Socrates: Human Liberation, Divine Guidance and Philosophy*. Vol. XVI, SAPERE. Tübingen: Mohr Siebeck, 2010.
- Neugebauer, O., and Richard A. Parker. *Egyptian Astronomical Texts*. (1. *The Early Decans*. 2. *The Ramesside Star Clocks*. 3. *Decans, Planets, Constellations and Zodiacs*). 4 vols. Providence: Brown University Press, 1960–1969.
- Neugebauer, Otto. 'Demotic Horoscopes'. *JAOS* 63, no. 2 (1943): 115–27.
- Neugebauer, Otto, and Matthew Black. *The 'Astronomical' Chapters of the Ethiopic Book of Enoch (72 to 82)*, Matematisk-fysiske Meddelelser; 40:10. Copenhagen: Det Kongelige Danske Videnskabernes Selskab, 1981.
- Neugebauer, Otto, and Richard A. Parker. 'Two Demotic Horoscopes'. *JEA* 54 (1968): 231–35.
- Neugebauer, O., and H. B. Van Hoesen. *Greek Horoscopes*. Philadelphia: The American Philosophical Society, 1959, repr. 1987.
- Olympiodorus. *Eis ton Paulon <Heliodorou>. Heliodori, ut dicitur, in Paulum Alexandrinum Commentarium*. Edited by Emilie Boer. Leipzig: B. G. Teubner, 1962.
- . *Commentary on Paulus's Introduction*. In *Late Classical Astrology: Paulus Alexandrinus and Olympiodorus with the Scholia from Later Commentators*. Translated and annotated by Dorian Gieseler Greenbaum. Edited by Robert Hand. Reston, VA: ARHAT, 2001.
- Origen. *Contre Celse*. Edited by Marcel Borret. 5 vols. Paris: Les Éditions du Cerf, 1967–76.

- . *Origen: Contra Celsum*. Translated and annotated by Henry Chadwick. Cambridge: Cambridge University Press, 1965.
- Orphei Hymni*. 3rd ed. Edited by Wilhelm Quandt. Berlin: Weidmann, 1955, repr. 1973.
- The Orphic Hymns*. Translated, introduction and annotations by Apostolos N. Athanassakis and Benjamin M. Wolkow. Baltimore: The Johns Hopkins University Press, 2013.
- The Orphic Hymns: Text, translation and notes*. Edited and translated by Apostolos N. Athanassakis. Vol. 12, Texts and translations; vol. 4, Graeco-Roman Religion Series. Missoula, MT: Scholars Press for the Society of Biblical Literature, 1977.
- Page, D. L. *Select Papyri III: Literary Papyri, Poetry*. Loeb Classical Library. London/Cambridge, MA: Harvard University Press, 1950.
- Parmenides. *Parmenides of Elea: Fragments. A text and translation with an introduction*. Translated by David Gallop. Toronto: University of Toronto Press, 1984.
- . *Parmenides: A Text with Translation, Commentary and Critical Essays*. Translated and commentary by Leonardo Tarán. Princeton: Princeton University Press, 1965.
- Paulus Alexandrinus. *Elementa Apotelesmatica*. Edited by Emilie Boer. Leipzig: B. G. Teubner, 1958.
- . *Introduction to Astrology*. In *Late Classical Astrology: Paulus Alexandrinus and Olympiodorus with the Scholia from Later Commentators*. Translated and annotated by Dorian Gieseler Greenbaum. Edited by Robert Hand. Reston, VA: ARHAT, 2001.
- Pausanias. *Graeciae descriptio*. Edited by Maria Helena Rocha-Pereira. Leipzig: B. G. Teubner, 1973–1981.
- . *Description of Greece*. Vol. 1. Translated by W. H. S. Jones. Loeb Classical Library. Cambridge, MA: Harvard University Press, 1918.
- Perdu, Olivier. 'Un appel à Isis (statue Londres, BM [1162])'. *Cd'É* 74, no. 148 (1999): 231–39.
- Petrie, W. M. Flinders, J. H. Walker, and E. B. Knobel. *Athribis*. Vol. 14, British School of Archaeology in Egypt. London: School of Archaeology in Egypt, University College and Bernard Quaritch, 1908.
- Philo of Alexandria. *De providentia I et II*. Translated, introduction and annotations by Mireille Hadas-Lebel. Paris: Éditions du Cerf, 1973.
- . *Legatio ad Gaium*. In *Opera quae supersunt*, vol. 6. Edited by Siegfried Reiter. Berlin: W. de Gruyter, 1962.
- Picatrix: The Latin Version of the Ghāyat al-ḥakīm*. Edited by David Pingree. Vol. 39, Studies of the Warburg Institute. London: Warburg Institute, 1986.
- Pindar. *Pindari carmina cum fragmentis, part 1*. Edited by Herwig Maehler and Bruno Snell. Bibliotheca scriptorum Graecorum et Romanorum Teubneriana. Leipzig: B. G. Teubner, 5th edition, 1971.
- Pingree, David. 'The Horoscope of Constantine VII Porphyrogenitus'. *Dumbarton Oaks Papers* 27 (1973): 217 + 219–31.

- Pingree, David, ed., trans. and comm. *The Yavanajātaka of Sphujidhvaja*. 2 vols. Cambridge, MA/London: Harvard University Press, 1978.
- Pistis Sophia*. Edited by Carl Schmidt. Translated and annotated by Violet MacDermot. Nag Hammadi Studies 9. Leiden: Brill, 1978.
- Plato. *Apology*. In *Platonis Opera*, vol. 1. Edited by John Burnet. Oxford: Clarendon Press, 1905.
- (Pseudo-)Plato. *Epinomis*. In *Platonis Opera*, vol. 5.2. Edited by John Burnet. Oxford: Clarendon Press, 1907, repr. 1967.
- . *Epistula VII*. In *Platonis Opera*, vol. 5.2. Edited by John Burnet. Oxford: Clarendon Press, 1907.
- Plato. *Laws*. In *Platonis Opera*, vols 5.1 and 5.2. Edited by John Burnet. Oxford: Clarendon Press, 1907–1913.
- . *Laws*. Translated by R. G. Bury. Loeb Classical Library. Cambridge, MA: Harvard University Press, 1926, repr. 1967.
- . *Phaedrus*. In *Platonis Opera*, vol. 2. Edited by John Burnet. Oxford: Clarendon Press, 1910.
- . *Platonis Opera*. Edited by John Burnet. Vol. 4. Oxford: Clarendon Press, 1902, repr. 1968.
- . *Republic*. In *Platonis Opera*, vol. 4. Edited by John Burnet. Oxford: Clarendon Press, 1905.
- . *Symposium*. In *Platonis Opera*, vol. 2. Edited by John Burnet. Oxford: Clarendon Press, 1910.
- . *Theages*. In *Platonis Opera*, vol. 3. Edited by John Burnet. Oxford: Clarendon Press, 1903, repr. 1909.
- . *Timaeus*. In *Platonis Opera*, vol. 4. Edited by John Burnet. Oxford: Clarendon Press, 1905.
- . *Timaeus*. Translated by R. G. Bury. In *Plato*, ix. Loeb Classical Library. Cambridge, MA: Harvard University Press, 1929, repr. 1989.
- . *Dialogues of Plato*. Translated by Benjamin Jowett. Vol. 3: *Republic, Timaeus, Critias*. Oxford: Clarendon Press, 1892.
- . *Dialogues of Plato*. Translated by Benjamin Jowett. Vol. 5: *Laws, Index*. Oxford: Clarendon Press, 1892.
- Pliny the Elder. *Natural History*. Translated by Harris Rackham. Vol. 1, Loeb Classical Library. Cambridge, MA: Harvard University Press, 1938.
- . *Natural History*. Translated by W. H. S. Jones. Vol. VIII, Loeb Classical Library. Cambridge, MA: Harvard University Press, 1963, repr. 1989.
- Plotinus. *Opera*. Edited by Paul Henry and Hans-Rudolf Schwyzer. 3 vols. Leiden: Brill, 1951–1973.
- . *Plotinus Ennead II*. Translated by H. A. Armstrong. Loeb Classical Library. Cambridge, MA/London: Harvard University Press, 1967, repr. 2006.

- . *Plotinus Ennead III*. Translated by A. H. Armstrong. Loeb Classical Library. Cambridge, MA/London: Harvard University Press, 1967, repr. 2006.
- . *Plotinus, The Enneads*. Translated by Stephen MacKenna. London: Faber and Faber, 1956.
- Plutarch. *Amatorius*. Translated by W. C. Helmbold. In *Moralia*, IX. Loeb Classical Library. Cambridge: Harvard University Press, 1961, repr. 1999.
- . *De animae procreatione in Timaeo*. Translated by Harold Cherniss. In *Moralia*, XIII, part 1. Loeb Classical Library. Cambridge, MA: Harvard University Press, 1976, repr. 2000.
- . *De defectu oraculorum*. Translated by Frank Cole Babbitt. In *Moralia*, V. Loeb Classical Library. Cambridge, MA: Harvard University Press, 1936, repr. 2003.
- . *De facie quae in orbe lunae apparet*. Translated by Harold Cherniss and W. C. Helmbold. In *Moralia*, XII. Loeb Classical Library. Cambridge, MA: Harvard University Press, 1957, repr. 2001.
- (Pseudo-)Plutarch. *De fato*. Edited, translation and commentary by Ernesto Valgiglio. Rome: A. Signorelli, 1964.
- . *De fato*. In *Plutarchi Moralia*, vol. 3. Edited by Wilhelm Sieveking. Leipzig: Teubner, 1929, repr. 1972.
- . *De fato*. Translated by Phillip H. De Lacy and Benedict Einarson. In *Moralia*, VII. Loeb Classical Library. Cambridge, MA: Harvard University Press, 1959, repr. 2000.
- Plutarch. *De fortuna Romanorum*. Translated by Frank Cole Babbitt. In *Moralia*, IV. Loeb Classical Library. Cambridge, MA: Harvard University Press, 1936, repr. 2005.
- . *De genio Socratis*. In *Plutarchi moralia*, vol. 3. Edited by Wilhelm Sieveking. Leipzig: B. G. Teubner, 1929, repr. 1972.
- . *De genio Socratis*. Translated by Phillip H. De Lacy and Benedict Einarson. In *Moralia*, VII. Loeb Classical Library. Cambridge, MA: Harvard University Press, 1959, repr. 2000.
- . *De Iside et Osiride*. In *Plutarchi moralia*, vol. 2.3. Edited by Wilhelm Sieveking. Leipzig: B. G. Teubner, 1935.
- . *Plutarch's de Iside et Osiride*. Edited, translated and commentary by J. Gwyn Griffiths. Cardiff: University of Wales Press, 1970.
- . *De Iside et Osiride*. Translated by Frank Cole Babbitt. In *Moralia*, V. Loeb Classical Library. Cambridge, MA: Harvard University Press, 1936, repr. 2003.
- . *Oeuvres morales, Tome VIII. Du destin—Le démon de Socrate—De l'exil—Consolation à sa femme*. Edited and translated by Jean Hani. Paris: Les Belles Lettres, 1980.
- (Pseudo-)Plutarch. *Placita philosophorum*. In *Plutarchi Moralia*, vol. 5.2.1. Edited by Jürgen Mau. Bibliotheca scriptorum Graecorum et Romanorum Teubneriana (Scriptores Graeci). Leipzig: B. G. Teubner, 1971.

- Plutarch. *Platonicae Quaestiones*. Translated by Harold Cherniss. In *Moralia*, XIII, Part 1. Loeb Classical Library. Cambridge, MA: Harvard University Press, 1976, repr. 2000.
- . *Quaestiones convivales*. Edited and translated by F. H. Sandbach. In *Moralia*, IX. Loeb Classical Library. Cambridge, MA: Harvard University Press, 1961, repr. 1999.
- . *De sera numinis vindicta*. Translated by Phillip H. De Lacy and Benedict Einarson. In *Moralia*, VII. Loeb Classical Library. Cambridge, MA: Harvard University Press, 1959, repr. 2000.
- . *De superstitione*. Translated by Frank Cole Babbitt. In *Moralia*, II. Loeb Classical Library. Cambridge, MA: Harvard University Press, 1928, repr. 2002.
- . *Vitae parallelae*. Edited by Claes Lindskog and Konrat Ziegler. 6 vols. Leipzig: B. G. Teubner, 1960–1973.
- . *Lives*. Translated by Bernadotte Perrin. 11 vols, Loeb Classical Library. Cambridge, MA/London: Harvard University Press, 1914–1926.
- Porphyry. *De l'abstinence*. Edited by Jean Bouffartigue and Michel Patillon. 3 vols. Paris: Les Belles Lettres, 1977–1995.
- . *Porphyry. On Abstinence from Killing Animals*. Translated and annotated by Gillian Clark. Ancient Commentators on Aristotle. London: Duckworth, 2000.
- . *Porphyry, The Cave of the Nymphs in the Odyssey*. Edited by Seminar Classics 609, State University of New York at Buffalo, J. M. Duffy, P. F. Sheridan, L. G. Westerink and J. A. White. Arethusa Monograph 1. Buffalo, NY: Department of Classics, State University of New York at Buffalo, 1969.
- . *Fragments*. Edited by Andrew Smith. Stuttgart/Leipzig: B. G. Teubner, 1993.
- . *Introduction to the Tetrabiblos*. In *CCAG* V/4, 185–228. Edited by Emilie Boer and Stefan Weinstock. Brussels: Henri Lamertin, 1940.
- . *Porphyrii philosophi introductio (Introduction to Ptolemy's Tetrabiblos)*. In *In Claudii Ptolemaei Quadripartitum enarrator ignoti nominis, quem tamen Proclum fuisse quidam existimant; Porphyrii philosophi introductio in Ptolemaei opus de effectibus astrorum; Hermetis philosophi de revolutionibus nativatum libri duo incerto interprete*. Edited by Hieronymus Wolf. Basle: Hieronymus Wolf, 1559.
- . *Lettera ad Anebo*. Edited by A. R. Sodano. Naples: L'arte tipografica, 1958.
- . *Opuscula selecta*. Edited by August Nauck. Leipzig: B. G. Teubner, 1886.
- . *Περὶ τοῦ ἐφ' ἡμῖν*. In Johannes Stobaeus, *Ioannis Stobaei Anthologium*, vol. II. Edited by Curt Wachsmuth, 163–73. Berlin: Weidmann, 1884.
- . *Porphyry: To Gaurus on How Embryos are Ensouled and On What is in Our Power*. Translated and commentary by James Wilberding. Ancient Commentators on Aristotle. London: Bristol Classical Press/Gerald Duckworth and Company, 2011.
- . *Porphyre: La vie de Plotin*. Edited, translated and commentary by Luc Brisson. 2 vols. Vol. II. Vol. 16, Histoire des doctrines de l'Antiquité classique. Paris: Librairie Philosophique J. Vrin, 1992.

- . *Vita Plotini*. In *Plotini Opera*, vol. 1. Edited by Paul Henry and Hans-Rudolf Schwyzer. Paris: Desclée de Brouwer, 1951–1973.
- . *Life of Plotinus*. In *Neoplatonic Saints: The Lives of Plotinus and Proclus by their Students*. Translated by Mark Edwards. Vol. 35, Translated Texts for Historians. Liverpool: Liverpool University Press, 2000.
- Posidonius. *Poseidonius. Die Fragmente*. Edited by Willy Theiler. 2 vols. Vol. 1. Berlin: De Gruyter, 1982.
- . *Posidonius*. Edited by L. Edelstein and I. G. Kidd. 3 vols. Vol. 1, *The Fragments*. Cambridge: Cambridge University Press, 1972, repr. 1989.
- Preisendanz, Karl. *Papyri Graecae Magicae. Die griechischen Zauberpapyri*. 2nd ed. Edited and translated by Karl Preisendanz. 2 vols. Stuttgart: B. G. Teubner, 1973–1974.
- Proclus Diadochus. *Commentary on the first Alcibiades of Plato*. Edited by L. G. Westerink. Amsterdam: North-Holland Publishing Co., 1954.
- . *Proclus: Alcibiades I, A Translation and Commentary*. Translated and commentary by William O'Neill. The Hague: Martinus Nijhoff, 1965.
- . *In Platonis Rem publicam commentarii*. Edited by Wilhelm Kroll. 2 vols. Leipzig: B. G. Teubner, 1899–1901.
- . *Proclus, Commentaire sur la République*. Translated and annotated by A. J. Festugière. 3 vols. Paris: Librairie Philosophique J. Vrin, 1970.
- Ptolemy, Claudius. *Ἀποτελεσματικά*. Edited by Wolfgang Hübner. Opera quae exstant omnia, vol. 111, 1. Stuttgart/Leipzig: B. G. Teubner, 1998.
- . *Ptolemy, Tetrabiblos*. Translated by F. E. Robbins. Loeb Classical Library. Cambridge, MA: Harvard University Press, 1940, repr. 1994.
- Quack, Joachim Friedrich. 'Ein astrologisches Ostrakon der frühen Kaiserzeit (oGlasgow D 1925.96)'. *Enchoria* 31 (2008–2009): 104–12.
- Ray, J. D. *The Archive of Ḥor*. Texts from Excavations. London: Egypt Exploration Society, 1976.
- Reymond, E. A. E. *From Ancient Egyptian Hermetic Writings*. From the contents of the libraries of the Suchos temples in the Fayyum, pt. 2. Vienna: In Kommission bei Verlag Brüder Hollinek, 1977.
- Rhetorius. *Compendium astrologicum secundum epitomen in cod. Paris. gr. 2425 servatam*. Edited by David Pingree and Stephan Heilen. Berlin/New York: De Gruyter, forthcoming.
- Robbins, F. E. 'P. Michigan 149, Astrological Treatise'. In *Papyri in the University of Michigan collection III: Miscellaneous Papyri*, edited by J. G. Winter, 62–117. Vol. 111. Ann Arbor: University of Michigan, 1936.
- Robbins, Frank Egleston. 'A New Astrological Treatise: Michigan Papyrus No. 1'. *CPh* 22, no. 1 (1927): 1–45.
- Rochberg, Francesca. *Babylonian Horoscopes*. Vol. 88, part 1, Transactions of the American Philosophical Society. Philadelphia: American Philosophical Society, 1998.

- Ross, Micah T. 'Horoscopic Ostraca from Medînet Mâdi'. Ph.D. Thesis, Brown University, 2006.
- Ross, Micah. 'A Provisional Conclusion to the Horoscopic Ostraca from Medînet Mâdi'. *EVO* 34 (2011): 47–80.
- Ruelle, C.-E. 'Le Livre Sacré sur les Décans'. *RPh* 32, no. 4 (1908): 247–77.
- Savio, Adriano, ed. *Numi Augg. Alexandrini. Catalogo della collezione Dattari*. Trieste: Giulio Bernardi Editore, 2007.
- Schenke Robinson, Gesine, Hans-Martin Schenke, and Uwe-Karsten Plisch, eds. *Das Berliner "Koptische Buch" (P 20915)*. 2 vols. Corpus scriptorum Christianorum Orientalium. Scriptores Coptici. Leuven: Peeters, 2004.
- Sethe, Kurt, ed. *Urkunden des ägyptischen Altertums*, Band 11, *Hieroglyphische Urkunden der griechisch-römischen Zeit*, Heft 111. Leipzig: J. C. Hinrichs'sche Buchhandlung, 1904–1916.
- , ed. *Urkunden des ägyptischen Altertums*, Band IV, *Urkunden der 18. Dynastie*. Leipzig: J. C. Hinrichs'sche Buchhandlung, 1906–1957.
- Shakespeare, William. *King Richard III*. In *The Arden Edition of the Works of William Shakespeare*, ed. Antony Hammond. London/New York: Methuen, 1981.
- Simpson, William Kelly, ed. and trans., Raymond O. Faulkner, trans., and Edward F. Wente, Jr., trans. *The Literature of Ancient Egypt: An Anthology of Stories, Instructions and Poetry*. New Haven/London: Yale University Press, 1972.
- Sophocles. *Aias*. In *Sophoclis fabulae*. Edited by H. Lloyd-Jones and N. G. Wilson. Oxford: Clarendon Press, 1990.
- Stobaeus, Johannes. *Anthologium*. Edited by Curt Wachsmuth. Vols I–II. Berlin: Weidmann, 1884.
- Strabo. *Geographica*. Edited by August Meineke. 3 vols. Leipzig: B. G. Teubner, 1877, repr. 1913–1921.
- . *The Geography of Strabo*. Translated by Horace Leonard Jones. 8 vols. Loeb Classical Library. Cambridge, MA: Harvard University Press, 1917–1932.
- Suidas. *Suidae Lexicon*. Edited by Ada Adler. 5 vols. Leipzig: B. G. Teubner, 1928–1938.
- Syncellus, Georgius. *Ecloga chronographica*. Edited by Alden A. Mosshammer. Leipzig: Teubner, 1984.
- . *The Chronography of George Synkellos: A Byzantine Chronicle of Universal History from the Creation*. Translated and annotated by William Adler and Paul Tuffin. Oxford: Oxford University Press, 2002.
- Synesius. *Aegyptii sive de providentia*. In *Opuscula*, vol. 11. Edited by Nicola Terzaghi. Rome: Publicae Officinae Polygraphicae, 1944.
- The Tabula of Cebes*. Translated by John T. Fitzgerald and L. Michael White. Vol. 24, Texts and Translations, Graeco-Roman Religion Series. Chico, CA: Scholars Press, 1983.
- Tacitus, Cornelius. *Historiarum Libri*. Vol. 11.1. Edited by Kenneth Wellesley. Leipzig: B. G. Teubner, 1989.

- . *The Histories*. Translated by Clifford H. Moore. 2 vols, Loeb Classical Library. Cambridge, MA: Harvard University Press, 1925.
- Tardieu, Michel. *Écrits Gnostiques. Codex de Berlin*. Translated by Michel Tardieu. Paris: Les Éditions du Cerf, 1984.
- Thesaurus Linguae Graecae*. Online database of texts in Greek. <http://www.tlg.uci.edu/>.
- Thesaurus Linguae Latinae, editus auctoritate et consilio academiarum quinque Germanicarum Berlinensis, Gottingensis, Lipsiensis, Monacensis, Vindobonensis*. Leipzig: B. G. Teubner, 1900-.
- Thessalus of Tralles. *De virtutibus herbarum*. In *Thessalos von Tralles*. Edited by Hans-Veit Friedrich. Vol. 28, Beiträge zur klassischen Philologie. Meisenheim am Glan: Hain, 1968.
- Thompson, Herbert. 'Demotic Horoscopes'. *PSBA* 34 (1912): 227–33.
- Thompson, R. Campbell. *The Devils and Evil Spirits of Babylonia, being Babylonian and Assyrian Incantations against the Demons, Ghouls, Vampires, Hobgoblins, Ghosts, and Kindred Evil Spirits which Attack Mankind*. 2 vols. Vol. 1, *Evil Spirits*. Vol. XIV, Luzac's Semitic Text and Translation Series. London: Luzac and Co., 1903.
- Totti, Maria. *Ausgewählte Texte der Isis- und Sarapis-Religion*. Vol. XII, Subsidia Epigraphica. Quellen und Abhandlungen zur griechischen Epigraphik. Hildesheim/Zurich/New York: Georg Olms Verlag, 1985.
- Trismegistos*. Interdisciplinary portal of papyrological and epigraphical resources. <http://www.trismegistos.org/index.html>.
- Vanderlip, Vera Frederika. *The Four Greek Hymns of Isidorus and the Cult of Isis*. Vol. 12, American Studies in Papyrology. Toronto: A. M. Hakkert Ltd., 1972.
- Vermaseren, Maarten Jozef. *Corpus inscriptionum et monumentorum religionis Mithriacae*. 2 vols. The Hague: M. Nijhoff, 1956–1960.
- Vettius Valens. *Anthologiarum libri*. Edited by Wilhelm Kroll. Berlin: Weidmann, 1908.
- . *Anthologiarum libri novem*. Edited by David Pingree. Leipzig: B. G. Teubner, 1986.
- . *Anthologies. Livre I*. Edited, translated and commentary by Joëlle-Frédérique Bara. Vol. 111, Études préliminaires aux religions orientales dans l'Empire romain. Leiden: E. J. Brill, 1989.
- . *The Anthology, Books I–VII*. Translated by Robert Schmidt. 6 vols. Berkeley Springs, WV/Cumberland, MD: Golden Hind Press, 1993–2001.
- . *Anthology Book II, Part 1*. Translated by Robert Schmidt. Edited by Robert Hand. Berkeley Springs, WV: Golden Hind Press, 1994.
- . *The Anthology, Book II (concl.), & Book III*. Translated by Robert Schmidt. Edited by Robert Hand. Berkeley Springs, WV: The Golden Hind Press, 1994.
- . *The Anthology Book IV*. Translated by Robert Schmidt. Berkeley Springs, WV: Golden Hind Press, 1996.
- . *Blütensträuße*. Translated by Otto Schönberger and Eberhard Knobloch, Subsidia Classica 7. St. Katharinen: Scripta Mercaturae, 2004.

- . ‘Draft translation of Vettius Valens, Anthologiai, Books I–IX’. Translated by Mark Riley. Unpublished Work at <http://www.csus.edu/indiv/r/rileymt/Vettius%20Valens%20entire.pdf>.
- Waldstein, Michael, and Frederik Wisse. *The Apocryphon of John: Synopsis of Nag Hammadi Codices II, 1; III, 1; and IV, 1; with BG 8502.2*. Vol. 33, Nag Hammadi and Manichaean Studies. Leiden/New York/Cologne: E. J. Brill, 1995.
- Winter, John Garrett, ed. *Papyri in the University of Michigan Collection: Miscellaneous Papyri*. Vol. 111. Ann Arbor: University of Michigan Press, 1936.
- Xenophon. *Anabasis*. In *Xenophon*, 111. Translated by Carleton L. Brownson. Loeb Classical Library. Cambridge, MA: Harvard University Press, 1922.
- Zosimus of Panopolis. *Zosimus of Panopolis on the Letter Omega*. Edited and translated by Howard M. Jackson. Missoula, MT: Scholars Press, 1978.
- . *Περὶ ὀργάνων καὶ χαμίνων γνήσια ὑπομνήματα περὶ τοῦ ω στοιχείου (On the Letter Omega)*. In *Les alchimistes grecs*, vol. 4.1. Edited by Michèle Mertens. Paris: Les Belles Lettres, 1995.

3 Secondary Sources

- Abry, Josèphe-Henriette. ‘Les noms des décans chez Firmicus Maternus (*Mathesis* IV, 22)’. *RPh* 67, no. 2 (1993): 197–228.
- Adamson, Grant. ‘Astrological Medicine in Gnostic Traditions’. In *Practicing Gnosis: Ritual, Magic, Theurgy and Liturgy in Nag Hammadi, Manichaean and Other Ancient Literature. Essays in Honor of Birger A. Pearson*, edited by April D. De Conick, Gregory Shaw and John D. Turner, 333–58. Leiden/Boston: Brill, 2013.
- . ‘The Old Gods of Egypt in Lost Hermetica and Early Sethianism’. In *Histories of the Hidden God: Concealment and Revelation in Western Gnostic, Esoteric, and Mystical Traditions*, edited by April D. DeConick and Grant Adamson, 58–86. Durham: Acumen Publishing Limited, 2013.
- Adamson, Peter. ‘Plotinus on Astrology’. *OSAPh* 35 (2008): 265–91.
- Addey, Crystal. *Divination and Theurgy in Neoplatonism: Oracles of the Gods*. Ashgate Studies in Philosophy & Theology in Late Antiquity. Farnham, Surrey/Burlington, VT: Ashgate, 2014.
- Afonasin, Eugene. ‘The *Kybernetikē Technē* Metaphor in the Platonic Tradition’. Paper presented at the 12th Annual Conference of the International Society for Neoplatonic Studies, Lisbon, Portugal, 16–21 June 2014.
- Alexander, Philip S. ‘Contextualizing the Demonology of the Testament of Solomon’. In *Die Dämonen. Die Dämonologie der israelitisch-jüdischen unfrühchristlichen Literatur im Kontext ihrer Umwelt. Demons: The Demonology of Israelite-Jewish and Early*

- Christian Literature in Context of their Environment*, edited by Armin Lange, Hermann Lichtenberger and K. F. Diethard Römheld, 613–35. Tübingen: Mohr Siebeck, 2003.
- Amand, David. *Fatalisme et liberté dans l'antiquité grecque*. Vol. 3, fasc. 19, Recueil de travaux d'histoire et de philologie. Louvain: Bibliothèque de l'Université, 1945, repr. Amsterdam: Adolf M. Hakkert, 1973.
- Armstrong, A. H. 'Dualism: Platonic, Gnostic, and Christian'. In *Neoplatonism and Gnosticism*, edited by Richard T. Wallis and Jay Bregman, 33–54. Albany, NY: State University of New York Press, 1992.
- Arya, Darius Andre. 'The Goddess Fortuna in Imperial Rome: Cult, Art, Text'. Ph.D. Thesis, University of Texas at Austin, 2002.
- Athanassiadi, Polymnia. 'Dreams, Theurgy and Freelance Divination: The Testimony of Iamblichus'. *JRS* 83 (1993): 115–30.
- Aveni, Anthony, and G. Romano. 'Orientation and Etruscan Ritual'. *Antiquity* 68 (1994): 545–63.
- Bakhouché, Béatrice. *L'Astrologie à Rome*. Bibliothèque d'Études Classiques. Louvain/Paris/Sterling, VA: Peeters, 2002.
- Barnes, Jonathan. *Early Greek Philosophy*. London/New York: Penguin Books, 1987.
- Barrett, Caitlín E. *Egyptianizing Figurines from Delos: A Study in Hellenistic Religion*. Vol. 36, Columbia Studies in the Classical Tradition. Leiden/Boston: Brill, 2011.
- Barton, Tamsyn. *Ancient Astrology*. London/New York: Routledge, 1994.
- . 'Augustus and Capricorn: Astrological Polyvalency and Imperial Rhetoric'. *JRS* 85 (1995): 33–51.
- Beare, Rhona. 'Ptolemy's Daimon and Ruler-Cult'. *Klio* 62, no. 2 (1980): 327–30.
- Beck, Roger. *Beck on Mithraism: Collected Works with New Essays*. Ashgate Contemporary Thinkers on Religion: Collected Works. Aldershot/Burlington, VT: Ashgate, 2004.
- . *A Brief History of Ancient Astrology*. Oxford/Malden, MA: Blackwell, 2007.
- . 'Mithraism Since Franz Cumont'. In *ANRW*, edited by Wolfgang Haase, 2002–115. Vol. 11.17.4, Berlin: Walter de Gruyter & Co., 1984.
- . 'The Mysteries of Mithras: A New Account of Their Genesis'. *Journal of Roman Studies* 88 (1998): 115–28.
- . *Planetary Gods and Planetary Orders in the Mysteries of Mithras*. Vol. 109, Études préliminaires aux religions orientales dans l'Empire romain. Leiden/New York/Copenhagen: E. J. Brill, 1988.
- . *The Religion of the Mithras Cult in the Roman Empire: Mysteries of the Unconquered Sun*. Oxford: Oxford University Press, 2006.
- . 'Review: Dirk Obbink (ed.), *Anubio, Carmen astrologicum elegiacum*'. 2007. Bryn Mawr Classical Review, <http://ccat.sas.upenn.edu/bmcr/2007/2007-09-28.html>.
- . 'The Seat of Mithras at the Equinoxes: Porphyry, *De Antro Nympharum* 24'. *Journal of Mithraic Studies* 2 (1977): 95–98.

- . ‘Thus Spake Not Zarathuštra: Zoroastrian Pseudepigrapha of the Greco-Roman World’. In *A History of Zoroastrianism. Zoroastrianism under Macedonian and Roman Rule* (vol. 3), edited by Mary Boyce and Frantz Grenet. Leiden: E. J. Brill, 1991.
- Beekes, Robert S. P. *Etymological Dictionary of Greek*. <http://dictionaries.brillonline.com/greek>.
- Behlmer-Loprieno, Heike. ‘Zu einigen koptischen Dämonen’. *GM* 82 (1984): 7–23.
- Ben Yehuda, Eliezer. *Thesaurus totius hebraicitatis et veteris et recentioris*. Jerusalem/Berlin-Schöneberg: Langenscheidt, 1959.
- Bergman, Jan. ‘Ancient Egyptian Theogony in a Greek Magical Papyrus (PGM VII, ll. 516–521)’. In *Studies in Egyptian Religion: Dedicated to Professor Jan Zandee*, edited by Heerma van Voss, Matthieu Sybrand and Huibert Gerard, 28–37. Leiden: E. J. Brill, 1982.
- . ‘“I Overcome Fate, Fate Harkens to Me”’. In *Fatalistic Beliefs in Religion, Folklore, and Literature*, edited by Helmer Ringgren, 35–51. Stockholm: Almqvist & Wiksell, 1967.
- . *Ich bin Isis: Studien zum memphitischen Hintergrund der griechischen Isisaretalogien*. Uppsala: Universitets biblioteket, 1968.
- Bernard, A. *Le Delta égyptien d'après les textes grecs*. Vol. 1, *Les confins libyques*. Vol. 91, MIFAO. Cairo: Institut français d'archéologie orientale, 1970.
- Betz, Hans Dieter. ‘The Delphic Maxim “Know Yourself” in the Greek Magical Papyri’. *History of Religions* 21, no. 2 (1981): 156–71.
- Bezza, Giuseppe. *Arcana Mundi: Antologia del pensiero astrologico antico*. 2 vols. Milan: Rizzoli, 1995.
- . ‘Astrologia greca dopo Tolomeo: Retorio’. In *Homo Mathematicus: Actas del Congreso Internacional sobre Astrólogos Griegos y Romanos (Benalmádena, 8–10 Octubre de 2001)*, edited by Aurelio Pérez Jiménez and Raúl Caballero, 177–203. Málaga: Charta Antiqua, 2002.
- . ‘Astrological Considerations on the Length of Life in Hellenistic, Persian and Arabic Astrology’. *Culture and Cosmos* 2, no. 2 (1998): 3–15.
- . ‘The Development of an Astrological Term—from Greek *hairesis* to Arabic *ḥayyiz*’. *Culture and Cosmos* 11, no. 1 and 2 (2007): 229–60.
- . ‘Sulla tradizione del Thema Mundi’. In *Giovanni Schiaparelli: storico della astronomia e uomo di cultura. Atti del Seminario di studi organizzato dall'Istituto Italiano per l'Africa e l'Oriente e dall'Istituto di Fisica Generale Applicata dell'Università degli Studi di Milano. Milano, 12–13 Maggio 1997, Osservatorio Astronomico di Brera*, edited by Antonio Panaino and Guido Pellegrini, 169–85. Milan: Mimesis—Istituto italiano per l'Africa e l'Oriente, 1999.
- Bianchi, Ugo. ‘Mithraism and Gnosticism’. In *Mithraic Studies: Proceedings of the First International Congress of Mithraic Studies*, edited by John R. Hinnells, vol. 11, 457–65. Manchester: Rowman and Littlefield, 1975.

- Bidez, Joseph. *Vie de Porphyre: Le philosophe Néo-Platonicien*. Ghent/Leipzig: E. Van Goethem/B. G. Teubner, 1913.
- Bidez, Joseph, and Franz Valery Marie Cumont. *Les mages hellénisés: Zoroastre, Ostanès et Hystaspe d'après la tradition grecque*. 2 vols. Paris: Société d'éditions 'Les Belles Lettres', 1938.
- Black, Jeremy A., and Anthony Green. *Gods, Demons, and Symbols of Ancient Mesopotamia: An Illustrated Dictionary*. London: British Museum Press for the Trustees of the British Museum, 1992.
- Blair, Judit M. *De-Demonising the Old Testament. An Investigation of Azazel, Lilith, Deber, Qeteb and Reshef in the Hebrew Bible*. Vol. 37, FAT II. Tübingen: Mohr Siebeck, 2009.
- Blasius, A., and B. U. Schipper, eds. *Apokalyptik und Ägypten: eine kritische Analyse der relevanten Texte aus dem griechisch-römischen Ägypten*. Vol. 107, OLA. Leuven/Paris/Sterling, VA: Peeters, 2002.
- Bleeker, C. J. 'Die Idee des Schicksals in der alt-ägyptischen Religion'. In *The Sacred Bridge*, 112–29. Leiden: E. J. Brill, 1963.
- Blumenthal, Elke. *Untersuchungen zum ägyptischen Königtum des Mittleren Reiches, I. Die Phraseologie*. Berlin: Akademie-Verlag, 1970.
- den Boeft, J. *Calcidius on Fate: His Doctrine and Sources*. Vol. 18, Philosophia Antiqua: A Series of Monographs on Ancient Philosophy. Leiden: E. J. Brill, 1970.
- Boer, Emilie. 'Vettius Valens'. In *Paulys Realencyclopädie der Classischen Altertumswissenschaft*, Zweite Reihe, vol. VIII.2, cols 1871–73. Stuttgart: Metzler, 1958.
- Bohak, Gideon. 'Hebrew, Hebrew Everywhere? Notes on the Interpretation of the *Voces Magicae*'. In *Prayer, Magic, and the Stars in the Ancient and Late Antique World*, edited by Scott Noegel, Joel Walker and Brandon Wheeler, 69–82. University Park, PA: The Pennsylvania State University Press, 2003.
- Bohême, Marie-Ange. 'Divinity'. In *The Ancient Gods Speak*, edited by Donald B. Redford, 106–12. Oxford/New York: Oxford University Press, 2002.
- Boll, Franz. 'Hebdomas'. In *Paulys Real-Encyclopädie der classischen Altertumswissenschaft*, Neue Bearbeitung, Band VII.2. Stuttgart: J. B. Metzler, 1912.
- . *Kleine Schriften zur Sternkunde des Altertums*. Edited by Viktor Stegemann. Leipzig: Koehler & Amelang, 1950.
- . *Sphaera: Neue griechische Texte und Untersuchungen zur Geschichte der Sternbilder*. Leipzig: B. G. Teubner, 1903.
- . *Studien über Claudius Ptolemäus: ein Beitrag zur Geschichte der griechischen Philosophie und Astrologie*. Suppl. Band 21, *Jahrbucher für Classische Philologie*. Leipzig: B. G. Teubner, 1894.
- Boll, Franz, Carl Bezold, and Wilhelm Gundel. *Sternglaube und Sterndeutung: Die Geschichte und das Wesen der Astrologie*. 3rd ed. Leipzig/Berlin: B. G. Teubner, 1926.
- Bonnet, Hans. *Reallexikon der ägyptischen Religionsgeschichte*. Berlin: De Gruyter, 1952.

- Bottéro, Jean. *Mesopotamia: Writing, Reasoning and the Gods*. Translated by Zainab Bahrani and Marc Van De Mieroop. Chicago/London: University of Chicago Press, 1992.
- Bouché-Leclercq, Auguste. *Histoire de la divination dans l'antiquité*. 4 vols. Paris: E. Leroux, 1879–1882.
- . *L'astrologie grecque*. Paris: E. Leroux, 1899.
- Boulnois, Jean. *Le caducée et la symbolique dravidienne indo-méditerranéenne, de l'arbre, de la pierre, du serpent et de la déesse-mère*. Paris: Librairie d'Amérique et d'Orient, 1939.
- Bregman, Jay. 'Synesius, the Hermetica and Gnosis'. In *Neoplatonism and Gnosticism*, edited by Richard T. Wallis and Jay Bregman, 85–98. Albany: State University of New York Press, 1992.
- Brenk, Frederick E. 'Genuine Greek Demons, "In Mist Apparelled"? Hesiod and Plutarch'. In *Relighting the Souls: Studies in Plutarch, in Greek Literature, Religion and Philosophy, and in the New Testament Background*, edited by Frederick E. Brenk, 170–81. Stuttgart: F. Steiner, 1998.
- . *In Mist Apparelled: Religious Themes in Plutarch's Moralia and Lives*. Leiden: E. J. Brill, 1977.
- . 'In the Light of the Moon: Demonology in the Early Imperial Period'. In *ANRW*, edited by Wolfgang Haase, 2068–145. Vol. 11, 16.3, Berlin: De Gruyter, 1986.
- . 'Time as Structure in Plutarch's *The Daimonion of Sokrates*'. In *Relighting the Souls: Studies in Plutarch, in Greek Literature, Religion and Philosophy, and in the New Testament Background*, edited by Frederick E. Brenk, 59–81. Stuttgart: F. Steiner, 1998.
- Bril, Jacques. *Lilith ou La mère obscure*. Paris: Payot, 1981.
- van den Broek, Roelof. *Studies in Gnosticism and Alexandrian Christianity*. Leiden: E. J. Brill, 1996.
- Brodersen, Kai. 'Achilleus Tatios [2]'. In *Der Neue Pauly Enzyklopädie der Antike*, Band 1, col. 84. Stuttgart/Weimar: J. B. Metzler, 1996.
- Broekhuis, Jan. *De godin Renenwetet*. Bibliotheca Classica Vangorcumiana 19. Assen: Van Gorcum, 1971.
- Brown, Peter. 'The Diffusion of Manichaeism in the Roman Empire'. *JRS* 59, no. 1/2 (1969): 92–103.
- Broze, Michèle, and Carine Van Liefferinge. 'Le démon personnel et son rôle dans l'ascension théurgique chez Jamblique'. In *De Socrate à Tintin. Anges gardiens et démons familiers de l'Antiquité à nos jours*, edited by Jean-Patrice Boudet, Philippe Faure and Christian Renoux, 67–77. Rennes: Presses universitaires de Rennes, 2011.
- Brunius-Nilsson, Elisabeth. *Daimonie, an inquiry into a mode of apostrophe in old Greek literature*. Uppsala: Almqvist & Wiksells, 1955.

- Burkert, Walter. *Creation of the Sacred: Tracks of Biology in Early Religions*. Cambridge, MA: Harvard University Press, 1996.
- . *Greek Religion*. Translated by J. Raffan. Cambridge, MA: Harvard University Press, 1985, repr. 2001.
- . *The Orientalizing Revolution: Near Eastern Influence on Greek Culture in the Early Archaic Age*. Cambridge, MA: Harvard University Press, 1992, repr. 1995.
- . 'Signs, Commands, and Knowledge: Ancient Divination between Enigma and Epiphany'. In *Mantikê. Studies in Ancient Divination*, edited by Sarah Iles Johnston and Peter Struck, 29–49. Leiden: Brill, 2005.
- Burnet, John. *Early Greek Philosophy*. 4th ed. Cleveland/New York: The World Publishing Company, 1930, repr. 1961.
- Burnett, Charles. *Magic and Divination in the Middle Ages: Texts and Techniques in the Islamic and Christian Worlds*. Aldershot: Ashgate Variorum, 1996.
- . 'Ṭābit Ibn Qurra the Ḥarrānian on the Talismans and the Spirits of the Planets'. *La Corónica* 36.1 (2007): 13–40.
- de Callataj, Godefroid. *Annus Platonicus: a study of world cycles in Greek, Latin and Arabic Sources*. Louvain-La-Neuve: Université Catholique de Louvain, Institut Orientaliste, 1996.
- . 'The Knot of the Heavens'. *JWI* 59 (1996): 1–13.
- Callieri, Pierfrancesco. 'In the Land of the Magi. Demons and Magic in the Everyday Life of Pre-Islamic Iran'. *Res Orientales* 13 (*Démons et merveilles d'Orient*) (2001): 11–35.
- Campion, Nicholas. *The Dawn of Astrology: A Cultural History of Western Astrology*. Vol. 1. *The Ancient and Classical Worlds*. London: Continuum Books, 2008.
- Caquot, André. 'Anges et démons en Israël'. In *Génies, anges et démons. Égypte, Babylone, Israel, Islam etc.*, 113–52. Paris: Éditions de Seuil, 1971.
- Černý, Jaroslav, ed. *Coptic Etymological Dictionary*. Cambridge: Cambridge University Press, 1976, repr. 2010.
- Cerri, Giovanni. 'The Astronomical Section in Parmenides' Poem'. In *Parmenides, Venerable and Awesome (Plato, Theaetetus 183e)*. *Proceedings of the International Symposium (Buenos Aires, October 29–November 2, 2007)*, edited by Néstor-Luis Cordero, 81–94. Las Vegas/Zurich/Athens: Parmenides Publishing, 2011.
- Chantraine, Pierre. *Dictionnaire étymologique de la langue grecque: histoire des mots*. 4 vols. Paris: Klincksieck, 1968–1980.
- Charmasson, Thérèse. *Recherches sur une technique divinatoire: la géomancie dans l'Occident médiéval*. Vol. 44, Hautes études médiévales et modernes. Geneva/Paris: Librairie Droz/Librairie H. Champion, 1980.
- Clark, Stephen R. L. 'Reason as *Daimōn*'. In *The Person and the Human Mind: Issues in Ancient and Modern Philosophy*, edited by Christopher Gill, 187–206. Oxford: Clarendon Press, 1990.

- Clarke, Emma C. *Iamblichus' De mysteriis: A manifesto of the miraculous*. Aldershot/Burlington, VT/Singapore/Sydney: Ashgate Publishing Co., 2001.
- Cook, Albert. 'Heraclitus and the Conditions of Utterance'. *Arion* N. S. 2.4 (1975): 431–81.
- Cornelius, Geoffrey. 'Interpreting Interpretations: The Aphorism in the Practice of the Renaissance Astrologers'. In *From Māshā'allāh to Kepler: Theory and Practice in Medieval and Renaissance Astrology*, edited by Charles Burnett and Dorian Gieseler Greenbaum, 101–21. Ceredigion, Wales: Sophia Centre Press, 2015.
- . *The Moment of Astrology: Origins in Divination*. 2nd ed. Bournemouth: The Wessex Astrologer, 2004.
- Couliano, Ioan P. *Expériences de l'extase. Extase, ascension et récit visionnaire de l'Hellénisme au Moyen Âge*. Paris: Payot, 1984.
- Court de Gébelin, Antoine. 'Allégories Orientales'. In *Monde Primitif*. Vol. 1. Paris: Chez l'auteur, Boudet, Valleyre l'ainé et al., 1777.
- Cramer, Frederick H. *Astrology in Roman Law and Politics*. Chicago: Ares Publishers, Inc., 1954, repr. 1996.
- Cremer, Friedrich W. *Die Chaldäischen Orakel und Jamblich De mysteriis*. Heft 26, Beiträge zur klassischen Philologie. Meisenheim am Glan: A. Hain, 1969.
- Crum, W. E. *A Coptic Dictionary*. Oxford: Clarendon Press, 1939.
- Cruz-Uribe, Eugene. 'The Khonsu Cosmogony'. *JARCE* 31 (1994): 169–89.
- Culianu, Ioan Petru. *Psychnodia I. A Survey of the Evidence concerning the Ascension of the Soul and its Relevance*. Leiden: E. J. Brill, 1983.
- Cumont, Franz. 'Antiochus d'Athènes et Porphyre'. *L'Annuaire de l'Institut de Philologie et d'Histoire Orientales* 2 (Mélanges Bidez) (1933): 135–56.
- . *Astrology and Religion among the Greeks and Romans*. History of Religions Series 1911–1912. New York/London: G. P. Putnam's Sons, 1912.
- . 'Écrits hermétiques, II: Le médecin Thessalus et les plantes astrales d'Hermès Trismégiste'. *RPh* 42 (1918): 85–108.
- . *L'Égypte des astrologues*. Brussels: La Fondation égyptologique Reine Élisabeth, 1937.
- . 'La théologie solaire du paganisme romain'. In *Mémoires présentés par divers savants à l'Académie des Inscriptions et Belles-Lettres*, 1–33. Paris: C. Klincksieck, 1909.
- . 'Les noms des planètes et l'astrolatrie chez les Grecs'. *AC* 4, no. 1 (1935): 5–43.
- . *Les religions orientales dans le paganisme romain*. 4th ed. Paris: Librairie Orientaliste Paul Geuthner, 1929.
- . *The Mysteries of Mithra*. Translated by Thomas J. McCormack. Chicago: Open Court Publishing Company, 1903.
- . *Textes et monuments figurés relatifs aux mystères de Mithra*. 2 vols. Brussels: H. Lamertin, 1896–1899.

- Czachesz, István. '“As God Counsellor Socrates:” Commission Narratives in Cognitive Perspective'. In *Reflecting Diversity: Historical and Thematic Perspectives in the Jewish and Christian Tradition*, edited by Péter Losonczi and Géza Xeravits, 13–23. Berlin: LIT Verlag, 2007.
- Darcus, Shirley. "Daimon" as a Force Shaping "Ethos" in Heraclitus. *Phoenix* 28, no. 4 (1974): 390–407.
- Davies, T. Witton. *Magic, Divination, and Demonology among the Hebrews and their Neighbours*. London: James Clarke & Co., 1898.
- DeConick, April D. 'Apostles as Archons: The Fight for Authority and the Emergence of Gnosticism in the Tchacos Codex and other Early Christian Literature'. In *The Codex Judas Papers. Proceedings of the International Congress on the Tchacos Codex held at Rice University, Houston, Texas, March 13–16, 2008*, edited by April D. DeConick, 243–88. Leiden/Boston: Brill, 2009.
- . 'The Road for the Soul is Through the Planets: The Mysteries of the Ophians Mapped'. In *Practicing Gnosis: Ritual, Magic, Theurgy and Liturgy in Nag Hammadi, Manichaean and Other Ancient Literature. Essays in Honor of Birger A. Pearson*, edited by April D. DeConick, Gregory Shaw and John D. Turner, 37–74. Leiden/Boston: Brill, 2013.
- . *The Thirteenth Apostle: What the Gospel of Judas Really Says*. London: Continuum, 2007.
- Denningmann, Susanne. 'The Ambiguous Terms *ἑώρα* and *ἑσπερία ἀνατολή*, and *ἑώρα* and *ἑσπερία δύσις*'. *Culture and Cosmos* 11.1 and 2, no. 1 and 2 (2007): 189–210.
- . *Die astrologische Lehre der Doryphorie: Eine soziomorphe Metapher in der antiken Planetenastrologie*. Vol. 214, Beiträge zur Altertumskunde. Munich/Leipzig: K. G. Saur, 2005.
- Denzey Lewis, Nicola. *Cosmology and Fate in Gnosticism and Graeco-Roman Antiquity: Under Pitiless Skies*. Vol. 81, Nag Hammadi and Manichaean Studies. Leiden/Boston: Brill, 2013.
- Denzey, Nicola. 'Stalking Those Elusive Ophites: The Ophite Diagrams Reconsidered'. In *Essays in Honour of Frederik Wisse*, edited by Warren Kappeler, 89–122. Vol. 33, *ARC: Journal of the Faculty of Religious Studies*. Montreal: ARC: Journal of the Faculty of Religious Studies, McGill University, 2005.
- Derchain-Urtel, Maria Theresia. *Synkretismus in ägyptischer Ikonographie: Die Göttin Tjenenet*. Vol. 4, Synkretistische Erscheinungen in der altägyptischen Religion. Wiesbaden: Otto Harrassowitz, 1979.
- Detienne, Marcel. 'Xénocrate et la démonologie Pythagoricienne'. *REA* 60 (1958): 271–79.
- Deuse, Werner. 'Plutarch's eschatological myths'. In *Plutarch On the daimonion of Socrates: Human Liberation, Divine Guidance, and Philosophy*, edited by Heinz-Günther Nesselrath. Tübingen: Mohr Siebeck, 2010.

- Devevey, Frédéric, Christian Vernou, and Aurélie Rousseau. 'The Chevroches zodiacal cap and its Burgundy relations'. In *The Role of Astronomy in Society and Culture, E3, Proceedings of IAU Symposium No. 260, 2009*, edited by D. Valls-Gabaud and A. Boksenberg, 1–8. <https://halshs.archives-ouvertes.fr/halshs-00701470>, © International Astronomical Union, 2011.
- Dieleman, Jacco. *Priests, Tongues, and Rites: The London-Leiden Magical Manuscripts and Translation in Egyptian Ritual (100–300 CE)*. Vol. 153, Religions in the Graeco-Roman World. Leiden/Boston: Brill, 2005.
- . 'Stars and the Egyptian Priesthood in the Graeco-Roman Period'. In *Prayer, Magic, and the Stars in the Ancient and Late Antique World*, edited by Scott Noegel, Joel Walker and Brandon Wheeler, 137–53. University Park, PA: The Pennsylvania State University Press, 2003.
- Dijkstra, Klaas. *Life and Loyalty: A Study in the Socio-Religious Culture of Syria and Mesopotamia in the Graeco-Roman Period Based on Epigraphical Evidence*. Vol. 128, Religions in the Graeco-Roman World. Leiden: E. J. Brill, 1995.
- Dillon, John. *The Heirs of Plato: A Study of the Old Academy (347–274 BC)*. Oxford: Clarendon Press, 2003.
- . 'Iamblichus of Chalcis (c. 240–325 AD)'. In *ANRW*, edited by Wolfgang Haase, 862–909. Vol. 11.36.2, Berlin/New York: Walter de Gruyter, 1987.
- . 'Iamblichus on the Personal Daemon'. *AncW* 32.1 (2001): 3–9.
- . *The Middle Platonists: A Study of Platonism 80 BC to AD 220*. London: Gerald Duckworth and Company, 1977.
- . 'Plotinus on Whether the Stars are Causes'. *Res Orientales* 12 (*La Science des Cieux. Sages, mages, astrologues*) (1999): 87–92.
- Dillon, John, and Lloyd P. Gerson. *Neoplatonic Philosophy: Introductory Readings*. Indianapolis/Cambridge: Hackett Publishing Co., 2004.
- Dirven, Lucinda. *The Palmyrenes of Dura-Europos: A Study of Religious Interaction in Roman Syria*. Vol. 138, Religions in the Graeco-Roman World. Leiden/Boston/Cologne: Brill, 1999.
- Dodds, Eric Robertson. *The Ancient Concept of Progress and other Essays on Greek Literature and Belief*. Oxford: Clarendon Press, 1973.
- . *The Greeks and the Irrational*. Berkeley/Los Angeles/London: University of California Press, 1951.
- Donini, Pier Luigi. *Tre studi sull'aristotelismo nel 11 secolo d. C.* Turin: Paravia, 1974.
- Dousa, Thomas M. 'Imagining Isis: On Some Continuities and Discontinuities in the Image of Isis in Greek Isis Hymns and Demotic Texts'. In *Acts of the Seventh International Conference of Demotic Studies, Copenhagen, 23–27 August 1999*, edited by Kim Ryholt, 149–84. Copenhagen: Museum Tusulanum Press, 2002.
- Downey, Susan. 'Temples à escaliers: The Dura Evidence'. *California Studies in Classical Antiquity* 9 (1976): 21–39.

- Dragona-Monachou, Myrto. 'Divine Providence in the Philosophy of the Empire'. In *ANRW*, edited by Wolfgang Haase, 4418–90. Vol. 11, 36.7, Berlin: De Gruyter, 1994.
- Dunand, Françoise. 'Agathodaimon'. In *LIMC*. Vol. 1/1, Zurich/Munich: Artemis Verlag, 1981.
- . 'Les représentations de l'Agathodémon à propos de quelques bas-reliefs du Musée d'Alexandrie'. *BIFAO* 67 (1969): 9–48.
- Dunand, Françoise, and Christiane Zivie-Coche. *Gods and Men in Egypt: 3000 BCE to 395 CE*. Translated by David Lorton. Ithaca, NY: Cornell University Press, 2004.
- Edmonds, Radcliffe G., III. 'At the Seizure of the Moon: The Absence of the Moon in the Mithras Liturgy'. In *Prayer, Magic, and the Stars in the Ancient and Late Antique World*, edited by Scott Noegel, Joel Walker and Brandon Wheeler, 223–39. University Park, PA: The Pennsylvania State University Press, 2003.
- Edmunds, Lowell. 'Necessity, Chance and Freedom in the Early Atomists'. *Phoenix* 26, no. 4 (1972): 342–57.
- Edwards, Charles M. 'Tyche at Corinth'. *Hesperia* 59, no. 3 (1990): 529–42.
- Ego, Beate. 'Abraham [1]'. In *Der Neue Pauly Enzyklopädie der Antike*, Band 1, cols 29–30. Stuttgart/Weimar: J. B. Metzler, 1996.
- Eisler, Robert. *The Royal Art of Astrology*. London: Herbert Joseph Limited, 1946.
- Eitrem, Samson. 'Some Notes on the Demonology in the New Testament'. *Symbolae Osloenses* Fasc. Supplet. XII (1950): 1–60.
- Erman, Adolf, and Hermann Grapow. *Wörterbuch der ägyptische Sprache*. 6 vols + Suppl. Leipzig: Akademie Verlag, 1926–1953.
- Evans, James. 'The Astrologer's Apparatus: A Picture of Professional Practice in Greco-Roman Egypt'. *JHA* 35 (2004): 1–44.
- Even-Shoshan, Avraham. *Ha-milon ha-ḥadaš*. 8 vols. Jerusalem: Kiryat-sefer, 1974.
- Eyre, Chris. 'Fate, Crocodiles and the Judgement of the Dead: Some Mythological Allusions in Egyptian Literature'. *SAK* 4 (1976): 103–14.
- Farkas, Ann E., Prudence O. Harper, and Evelyn B. Harrison, eds. *Monsters and Demons in the Ancient and Medieval Worlds: Papers Presented in Honor of Edith Porada*. Mainz on Rhine: Philipp von Zabern, 1987.
- Faulkner, Raymond O. *A Concise Dictionary of Middle Egyptian*. Oxford: Griffith Institute, Oxford University Press, 1962.
- Ferwerda, Rein. 'Le serpent, le nœud d'Hercule et le caducée d'Hermès. Sur un passage orphique chez Athénagore'. *Numen* 20, no. 2 (1973): 104–15.
- Festugière, A.-J. *La révélation d'Hermès Trismégiste*. 3 vols. Vol. 1, *L'astrologie et les sciences occultes*. Vol. 75, Collection d'études anciennes. Série grecque. Paris: Les Belles Lettres, 1950, repr. 1989, 2006.
- . *La révélation d'Hermès Trismégiste*. 3 vols. Vol. 3, *Les doctrines de l'âme*. Vol. 75, Collection d'études anciennes. Série grecque. Paris: Les Belles Lettres, 1950, repr. 1989, 2006.

- Finamore, John F. 'Plutarch and Apuleius on Socrates' Daimonion'. In *The Neoplatonic Socrates*, edited by Danielle A. Layne and Harold Tarrant, 36–50. Philadelphia: University of Pennsylvania Press, 2014.
- Finkelberg, Aryeh. 'The Cosmology of Parmenides'. *AJPh* 107, no. 3 (1986): 303–17.
- Fontaine, Piet F. M. 'What is Dualism, and what is it not?' In *Light Against Darkness: Dualism in Ancient Mediterranean Religion and the Contemporary World*, edited by Armin Lange, Eric M. Meyers, Bennie H. Reynolds III and Randall Styers, 266–76. Göttingen: Vandenhoeck and Ruprecht, 2011.
- Fowden, Garth. *The Egyptian Hermes: A Historical Approach to the Late Pagan Mind*. Princeton: Princeton University Press, 1986, repr. 1993.
- Fraser, Kyle A. 'Zosimos of Panopolis and the Book of Enoch: Alchemy as Forbidden Knowledge'. *Aries* 4, no. 2 (2004): 125–47.
- Fraser, P. M. *Ptolemaic Alexandria*. 3 vols. Oxford: Clarendon Press, 1972.
- Frisk, Hjalmar. *Griechisches etymologisches Wörterbuch*. 3 vols. Heidelberg: Winter, 1960–1972.
- Frothingham, Arthur L. 'Babylonian Origin of Hermes the Snake-God, and of the Caduceus I'. *AJA* 20, no. 2 (1916): 175–211.
- Ganschietz, Richard. 'Agathodaimon [1]'. In *Paulys Realencyclopädie der Classischen Altertumswissenschaft*, Suppl. Bd. III, cols 37–59. Stuttgart: J. B. Metzler, 1918.
- García-Ballester, Luis. 'On the origin of the "six non-natural things" in Galen'. In *Galen and Galenism: Theory and Medical Practice from Antiquity to the European Renaissance*, edited by Jon Arrizabalaga, Montserrat Cabré, Lluís Cifuentes and Fernando Salmón, IV.105–15. Aldershot: Ashgate, 2002.
- Gardiner, Alan *Egyptian Grammar*. 3rd ed. Oxford: Oxford University Press, 1927, repr. 1969.
- Geller, M. J. 'Freud, Magic and Mesopotamia: How the Magic Works'. *Folklore* 108 (1997): 1–7.
- Gettings, Fred. *The Arkana Dictionary of Astrology*. London: Arkana/Penguin Books, 1985, repr. 1990.
- Gladwell, Malcolm. *Blink: The Power of Thinking Without Thinking*. New York: Little, Brown & Company, 2005.
- Glare, P. G. W., ed. *Oxford Latin Dictionary*. Vol. Fascicle VIII. Oxford: Clarendon Press, 1982.
- Gleadow, Rupert. *The Origin of the Zodiac*. London: Jonathan Cape, 1968.
- Glueck, Nelson. 'The Nabataean Temple of Khirbet et-Tannûr'. *BASOR* 67 (1937): 6–16.
- Goyon, Jean-Claude. 'L'origine égyptienne des tablettes décanales de Grand (Vosges), I'. In *Les tablettes astrologiques de Grand (Vosges) et l'astrologie en Gaule Romaine: actes de la Table-Ronde du 18 mars 1992 organisée au Centre d'Études Romaines et Gallo-Romaines de l'Université Lyon III*, edited by Josèphe-Henriette Abry, 63–76. Lyon: Centre d'Études Romaines et Gallo-Romaines, 1993.

- Grafton, Anthony T., and Noel M. Swerdlow. 'Calendar Dates and Ominous Days in Ancient Historiography'. *JWI* 51 (1988): 14–42.
- Grant, R. M. *Gnosticism and Early Christianity*. New York: Columbia University Press, 1959.
- Grant, Robert M. 'Les êtres intermédiaires dans le judaïsme tardif'. In *Le origini dello Gnosticismo. Colloquio di Messina 13–18 aprile 1966*, edited by Ugo Bianchi, 141–57. Leiden: E. J. Brill, 1967.
- Green, Anthony. 'Beneficent Spirits and Malevolent Demons'. *VRel* 3 (1984): 80–105.
- . 'Myths in Mesopotamian Art'. In *Sumerian Gods and Their Representations*, edited by Irving L. Finkel and Markham J. Geller, 135–58. Groningen: Styx Publications, 1997.
- Greenbaum, Dorian Gieseler. 'Arrows, Aiming and Divination: Astrology as a Stochastic Art'. In *Divination: Perspectives for a New Millennium*, edited by Patrick Curry, 179–209. Farnham, Surrey: Ashgate, 2010.
- . 'Calculating the Lots of Fortune and Daemon in Hellenistic Astrology'. *Culture and Cosmos* 11 (2007): 163–87.
- . 'The Lots of Fortune and Daemon in Extant Charts from Antiquity (First Century BCE to Seventh Century CE)'. *MHNH* 8 (2008): 173–90.
- . 'Rising to the Occasion: Appearance, Emergence, Light and Divination in Hellenistic Astrology'. In *The Imaginal Cosmos: Astrology, Divination and the Sacred*, edited by Angela Voss and Jean Hinson Lall, 9–24. Canterbury, Kent: University of Kent, School of European Culture and Languages, 2007.
- Greenbaum, Dorian Gieseler, and Micah T. Ross. 'The Role of Egypt in the Development of the Horoscope'. In *Egypt in Transition: Social and Religious Development of Egypt in the First Millennium BCE*, edited by Ladislav Bareš, Filip Coppens and Kvetta Smolarikova, 146–82. Prague: Faculty of Arts, Charles University in Prague, 2010.
- . 'Various Renderings of Πίναξ in Greek and Demotic at Medīnet Mādī'. In *Astrology in Time and Place*, edited by Nicholas Campion and Dorian Gieseler Greenbaum. Lampeter, Wales: Sophia Centre Press, in press.
- Greene, Liz. 'Did Orphic Beliefs Influence the Development of Hellenistic Astrology?' *Culture and Cosmos* 9.2 (2005): 21–45.
- Greene, William Chase. *Moirā: Fate, Good and Evil in Greek Thought*. New York/Evanston: Harper and Row, 1944, repr. 1963.
- Grene, David. 'Herodotus: The Historian as Dramatist'. *JPh* 58, no. 18 (1961): 477–88.
- Griffiths, J. Gwyn. 'Review: *Le Dieu Égyptien Shai dans la religion et l'ononastique* by Jan Quaegebeur'. *JEA* 64 (1978): 178–79.
- Gundel, Hans Georg. *Weltbild und Astrologie in den griechischen Zauberpapyri*. Vol. 53, Münchener Beiträge zur Papyrusforschung und antiken Rechtsgeschichte. Munich: C. H. Beck 1968.

- Gundel, Wilhelm. *Dekane und Dekansternbilder: Ein Beitrag zur Geschichte der Sternbilder der Kulturvölker*. Glückstadt/Hamburg: J. J. Augustin, 1936.
- Gundel, Wilhelm, and Hans Georg Gundel. *Astrologumena. Die astrologische Literatur in der Antike und ihre Geschichte*. Wiesbaden: Steiner, 1966.
- Guthrie, William Keith Chambers. *A History of Greek Philosophy*. 6 vols. Cambridge: Cambridge University Press, 1962–1981.
- . *Orpheus and Greek Religion: A Study of the Orphic Movement*. London: Princeton University Press, 1952. Reprint, 1993.
- Habinek, Thomas. 'Manilius' Conflicted Stoicism'. In *Forgotten Stars: Rediscovering Manilius' Astronomica*, edited by Steven J. Green and Katharina Volk, 32–44. Oxford: Oxford University Press, 2011.
- Hallum, Benjamin. 'Zosimus Arabus: The Reception of Zosimos of Panopolis in the Arabic/Islamic World'. Ph.D. Thesis, Warburg Institute, University of London, 2008.
- Hamilton, W. 'The Myth in Plutarch's *De Genio* (589F-592E)'. *CQ* 28, no. 3/4 (1934): 175–82.
- Hand, Robert. 'Fate and Astrology: Some Ancient Insights'. *The Mountain Astrologer Mercury Direct* section (February/March 2006): 2–11.
- . 'Signs as Houses (Places) in Ancient Astrology'. *Culture and Cosmos* 11.1 and 2 (2007): 135–62.
- . *Whole Sign Houses: The Oldest House System*. Reston, VA: ARHAT, 2000.
- Handler, Susan. 'Architecture on the Roman Coins of Alexandria'. *AJA* 75, no. 1 (1971): 57–74.
- Hankinson, R. J. *Cause and Explanation in Ancient Greek Thought*. Oxford: Clarendon Press, 1998.
- . 'Stoicism, Science and Divination'. *Apeiron* 21, no. 2 (1988): 123–60.
- Harder, Richard. *Karpokrates von Chalkis und die memphitische Isispropaganda*. Vol. 14, Abhandlungen der Preußischen Akademie der Wissenschaften. Berlin: De Gruyter, 1943 [1944].
- Hardie, Philip. 'Sign Language in *On the Sign of Socrates*'. In *Plutarchea Lovaniensia: A Miscellany of Essays on Plutarch*, edited by Luc Van der Stockt, 123–36. Louvain: Universitas Catholica Lovaniensis, 1996.
- Harpur, Patrick. *Daimonic Reality: Understanding Otherworld Encounters*. London: Arkana Penguin, 1995.
- Harrison, Jane Ellen. *Themis: A Study of the Social Origins of Greek Religion*. Cleveland/New York: World Publishing Company, 1927, repr. 1962.
- Heilen, Stephan. 'Anubio Reconsidered'. *Aestimatio* 7 (2010): 127–92.
- . 'The Emperor Hadrian in the Horoscopes of Antigonus of Nicaea'. In *Horoscopes and Public Spheres: Essays on the History of Astrology*, edited by Günther Oestmann, H. Darrel Rutkin and Kocku von Stuckrad, 49–67. Berlin/New York: De Gruyter, 2005.

- . 'Some metrical fragments from Nechepsos and Petosiris'. In *La poésie astrologique dans l'Antiquité*, edited by Isabelle Boehm and Wolfgang Hübner, 23–93. Paris: De Boccard, 2011.
- Henninger, Joseph. 'Beliefs in Spirits among the Pre-Islamic Arabs'. In *Magic and Divination in Early Islam*, edited by Emilie Savage-Smith, 1–53. Aldershot: Ashgate Variorum, 2004.
- Hillman, James. *The Soul's Code: In Search of Character and Calling*. New York: Warner Books, 1996, repr. 1997.
- Hoffmeier, James K. 'Fate'. In *The Ancient Gods Speak*, edited by Donald B. Redford, 120–23. Oxford/New York: Oxford University Press, 2002.
- Holden, James Herschel. *A History of Horoscopic Astrology from the Babylonian Period to the Modern Age*. Tempe, AZ: American Federation of Astrologers, 1996.
- Hopfner, Theodor. 'Das Diagramm der Ophiten'. In *Charisteria Alois Rzach zum achtzigsten Geburtstag dargebracht*, 86–98. Reichenberg: Stiepel, 1930.
- Hornblower, Simon, and Anthony Spawforth, eds. *Oxford Classical Dictionary*. Oxford/New York: Oxford University Press, 1996.
- Hornung, Erik. *Conceptions of God in Ancient Egypt: The One and the Many*. Translated by John Baines. Ithaca: Cornell University Press, 1982.
- Houlding, Deborah. *The Houses: Temples of the Sky*. Mansfield, Notts: Ascella, 1998.
- Howey, M. Oldfield. *The Encircled Serpent: A Study of Serpent Symbolism in All Countries and Ages*. New York: A. Richmond Co., 1926, repr. 1955.
- Hübner, Wolfgang. 'Les divinités planétaires de la Dodécatropos'. In *Les astres: actes du colloque international de Montpellier, 23–25 mars 1995*, edited by Béatrice Bakhouché, Alain Maurice Moreau and Jean-Claude Turpin, 307–17. Vol. 1, *Les astres et les mythes, la description du ciel*, Montpellier: Université Paul Valéry, 1996.
- . *Die Dodekatropos des Manilius: (Manil. 2, 856–970)*. Vol. 1995, no. 6, *Abhandlungen der Geistes- und Sozialwissenschaftlichen Klasse, Akademie der Wissenschaften und der Literatur (Mainz)*. Stuttgart: F. Steiner 1995.
- . *Die Eigenschaften der Tierkreiszeichen in der Antike: ihre Darstellung und Verwendung unter Besonderer Berücksichtigung des Manilius*. Wiesbaden: F. Steiner, 1982.
- . 'Manilius als Astrologe und Dichter'. In *ANRW*, edited by Wolfgang Haase, 126–320. Vol. II.32.1, Berlin/New York: Walter de Gruyter & Co., 1984.
- . 'Zur neoplatonischen Deutung und astrologischen Verwendung der Dodekaoros'. In *ΦΙΛΟΦΟΝΗΜΑ: Festschrift für Martin Sicherl zum 75. Geburtstag. Von Textkritik bis Humanismusforschung*, edited by Dieter Harlfinger, 73–103. Paderborn/Munich: Ferdinand Schöningh, 1990.
- . *Raum, Zeit und soziales Rollenspiel der vier Kardinalpunkte in der antiken Katarchenhoroskopie*. Vol. 194, *Beiträge zur Altertumskunde*. Munich/Leipzig: K. G. Saur Verlag, 2003.

- . 'Eine unbeachtete zodiakale Melothese bei Vettius Valens'. *RhM* 120, no. 3 & 4 (1977): 247–54.
- . 'Vettius Valens'. In *Der Neue Pauly Enzyklopädie der Antike*, Band XI1/2, cols 150–51. Stuttgart: Metzler, 2002.
- Hunger, Hermann, and David Pingree. *Astral Sciences in Mesopotamia*. Vol. 44, Handbuch der Orientalistik. Part 1, Der nahe und mittler Osten. Leiden/Boston/Cologne: Brill, 1999.
- Iversen, Erik. *Egyptian and Hermetic Doctrine*. Vol. 27, Opuscula Graecolatina. Copenhagen: Museum Tusulanum Press, 1984.
- Jacobsen, Thorkild. *The Treasures of Darkness: A History of Mesopotamian Religion*. New Haven/London: Yale University Press, 1976.
- Jameson, Michael H., David R. Jordan, and Roy D. Kotansky. *A Lex Sacra from Selinous*. Vol. 11, Greek, Roman and Byzantine Monographs. Durham, NC: Duke University, 1993.
- Jansen-Winkeln, Karl. 'Eine Grabübernahme in der 30. Dynastie'. *JEA* 83 (1997): 169–78.
- Jasnow, Richard. 'The Greek Alexander Romance and Demotic Egyptian Literature'. *JNES* 56, no. 2 (1997): 95–103.
- Johnson, Aaron P. *Religion and Identity in Porphyry of Tyre: The Limits of Hellenism in Late Antiquity*. Cambridge: Cambridge University Press, 2013.
- Johnson, Janet, ed. *Chicago Demotic Dictionary*. <http://oi.uchicago.edu/research/publications/demotic-dictionary-oriental-institute-university-chicago>: Oriental Institute, Chicago, 2001–2014.
- Johnston, Sarah Iles. *Hekate Soteira*. American Philological Association, American Classical Studies. Atlanta: Scholars Press, 1990.
- . 'The Testament of Solomon from Late Antiquity to the Renaissance'. In *The Metamorphosis of Magic from Late Antiquity to the Early Modern Period*, edited by Jan N. Bremmer and Jan R. Veenstra, 35–49. Leuven: Peeters, 2002.
- Johnston, Sarah Iles, and Peter Struck, eds. *Mantikê. Studies in Ancient Divination*. Vol. 155, Religions in the Graeco-Roman World. Leiden: Brill, 2005.
- Jones, C. P. 'Toward a Chronology of Plutarch's Works'. *JRS* 56, Parts 1 and 2 (1966): 61–74.
- de Jong, Albert. *Traditions of the Magi: Zoroastrianism in Greek and Latin Literature*. Vol. 133, Religions in the Graeco-Roman World. Leiden/New York: Brill, 1997.
- Junger, Sebastian. *The Perfect Storm: A True Story of Men Against the Sea*. New York: W. W. Norton & Co., 1997.
- Kákosy, L. 'Decans in Late-Egyptian Religion'. *Oikumene* 3 (1982): 163–91.
- Kaper, Olaf E. *The Egyptian God Tutu: A Study of the Sphinx-God and Master of Demons with a Corpus of Monuments*. Vol. 119, Orientalia Lovaniensia Analecta. Leuven: Peeters, 2003.
- Karamanolis, George, and Anne Sheppard, eds. *Studies on Porphyry*. London: *BICS* Supplement 98, 2007.

- Kingsley, Peter. *In the Dark Places of Wisdom*. Inverness, CA: The Golden Sufi Center, 1999.
- Kirk, Geoffrey Stephen, John Earle Raven, and Malcolm Schofield. *The Presocratic Philosophers: A Critical History with a Selection of Texts*. 2nd ed. Cambridge/New York: Cambridge University Press, 1983.
- Klutz, Todd. 'Jesus, Morton Smith and the *Eighth Book of Moses* (PGM 13.1–734)'. *Journal for the Study of the Pseudepigrapha* 21, no. 2 (2011): 133–59.
- Koch-Westenholz, Ulla. *Mesopotamian Astrology: An Introduction to Babylonian and Assyrian Celestial Divination*. Copenhagen: Museum Tusulanum Press, 1995.
- Koenen, Ludwig. 'Die Apologie des Töpfers an König Amenophis oder das Töpferorakel'. In *Apokalyptik und Ägypten: eine kritische Analyse der relevanten Texte aus dem griechisch-römischen Ägypten*, edited by A. Blasius and B. U. Schipper, 139–87. Leuven/Paris/Sterling, VA: Peeters, 2002.
- . 'A Supplementary Note on the Date of the Oracle of the Potter'. *ZPE* 54 (1984): 9–13.
- Komorowska, Joanna. 'The Lure of Egypt or How to Sound Like a Reliable Source'. In *Astrology and the Academy: Papers from the Inaugural Conference of the Sophia Centre, Bath Spa University College, 13–14 June 2003*, edited by Nicholas Campion, Patrick Curry and Michael York, 147–58. Bristol: Cinnabar Books, 2004.
- . 'Philosophical Foundation of Vettius Valens' Astrological Creed'. *Eos* 83 (1995): 331–35.
- . *Vettius Valens of Antioch: An Intellectual Monography*. Kraków: Księgarnia Akademicka, 2004.
- Kousoulis, Panagiotis. 'Introduction: The Demonic Lore of Ancient Egypt: Questions of Definition'. In *Ancient Egyptian Demonology: Studies on the Boundaries between the Demonic and the Divine in Egyptian Magic*, edited by P. Kousoulis, ix–xxi. Leuven/Paris/Walpole, MA: Peeters, 2011.
- Lalonde, Gerald V. *Horos Dios (HOPOΣ ΔΙΟΣ): An Athenian Shrine and Cult of Zeus*. Vol. XI, Monumenta Graeca et Romana. Leiden/Boston: Brill, 2006.
- Lancellotti, Maria Grazia. 'Gli gnostici e il cielo. Dottrine astrologiche e reinterpretazioni gnostiche'. *Stude e materiali di Storia delle Religioni* 66/n.s. 24, no. 1 (2000): 71–108.
- Langdon, S., and Alan H. Gardiner. 'The Treaty of Alliance between Ḫattušili, King of the Hittites, and the Pharaoh Ramesses II of Egypt'. *JEA* 6, no. 3 (1920): 179–205.
- Langdon, Stephen. 'Babylonian and Hebrew Demonology with reference to the supposed borrowing of Persian Dualism in Judaism and Christianity'. *JAS* (1934): 45–56.
- Lange, Armin, Eric M. Meyers, Bennie H. Reynolds III, and Randall Styers, eds. *Light Against Darkness: Dualism in Ancient Mesopotamian Religion and the Contemporary World*. Journal of Ancient Judaism Supplements. Göttingen: Vandenhoeck & Ruprecht, 2011.

- Langton, Edward. *Essentials of Demonology: A Study of Jewish and Christian Doctrine, Its Origin and Development*. London: Epworth Press, 1949.
- Lawrence, Marilyn. 'Hellenistic Astrology'. 2005. Internet Encyclopedia of Philosophy, <http://www.iep.utm.edu/ast-hel/>.
- . 'The Meaning of Astrology for Late Neoplatonists: Simplicius and Olympiodorus'. Paper presented at the 12th Annual Conference of the International Society for Neoplatonic Studies, Lisbon, Portugal, 16–21 June 2014.
- . 'Who Thought the Stars are Causes? The Astrological Doctrine Criticized by Plotinus'. In *Metaphysical Patterns in Platonism*, edited by John F. Finamore and Robert M. Berchman, 17–33. New Orleans: University Press of the South, 2007.
- Lawrence Moore, Marilyn. 'The Young Gods: The Stars and Planets in Platonic Treatment of Fate'. In *Perspectives sur le néoplatonisme. International Society of Neoplatonic Studies. Actes du colloque de 2006*, edited by Martin Achard, W.J. Hankey and Jean-Marc Narbonne, 95–109. Quebec: Presses de l'Université Laval, 2009.
- Layton, Bentley. *Coptic in 20 Lessons: Introduction to Sahidic Coptic with Exercises and Vocabularies*. Leuven/Paris/Dudley, MA: Peeters, 2007.
- Lehoux, Daryn. *Astronomy, Weather and Calendars in the Ancient World: Parapegmata and Related Texts in Classical and Near-Eastern Studies*. Cambridge: Cambridge University Press, 2007.
- . 'Tomorrow's News Today: Astrology, Fate and the Way Out'. *Representations* 95 (2006): 105–22.
- Leibovici, Marcel. 'Génies et démons en Babylonie'. In *Génies, anges et démons. Égypte, Babylone, Israël, Islam etc.*, 85–106. Paris: Éditions du Seuil, 1971.
- Leibovitch, Joseph. 'Gods of Agriculture and Welfare in Ancient Egypt'. *JNES* 12, no. 2 (1953): 73–113.
- Leisegang, Hans. *Die Gnosis*. Leipzig: A. Kröner, 1924.
- Leitz, Christian. *Altägyptische Sternuhren*. Vol. 62, *Orientalia Lovaniensia Analecta*. Leuven: Peeters, 1995.
- Levy, Harry L. 'Property Distribution by Lot in Present-Day Greece'. *TAPhA* 87 (1956): 42–46.
- Lewy, Hans, and Michel Tardieu, eds. *Chaldaean Oracles and Theurgy: Mysticism, Magic and Platonism in the Later Roman Empire*. Paris: Études augustinienes, 1978.
- Liddell, Henry George, Robert Scott, and Henry Stuart Jones. *A Greek-English Lexicon*. 9th ed. Oxford: Clarendon Press, 1996.
- von Lieven, Alexandra. *Der Himmel über Esna: eine Fallstudie zur religiösen Astronomie in Ägypten am Beispiel der kosmologischen Decken- und Architravinschriften im Tempel von Esna*. Wiesbaden: Harrassowitz, 2000.
- . 'Die dritte Reihe der Dekane oder Tradition und Innovation in der spätägyptischen Religion'. *ARG* 2 (2000): 21–36.

- . 'Divination in Ägypten'. *AoF* 26, no. 1 (1999): 77–126.
- . 'Gnosis and Astrology. "Book IV" of the Pistis Sophia'. In *Under One Sky. Astronomy and Mathematics in the Ancient Near East*, edited by John M. Steele and Annette Imhausen, 223–36. Münster: Ugarit-Verlag, 2002.
- . "'The Soul of the Sun Permeates the Whole World.'" Sun Cult and Religious Astronomy in Ancient Egypt'. *Pandanus '10* 4, no. 2 (2010): 29–60.
- Limet, Henri. 'Les démons méchants de la Babylonie'. In *Anges et démons: Actes du colloque de Liège et de Louvain-la-Neuve, 25–26 novembre 1987*, edited by Julien Ries and Henri Limet, 21–35. Louvain-la-Neuve: Centre d'histoire des religions, 1989.
- Lindsay, Jack. *Origins of Astrology*. London: Frederick Muller, 1971.
- Logan, Alastair H. B. *Gnostic Truth and Christian Heresy: A Study in the History of Gnosticism*. Edinburgh: T. & T. Clark Ltd., 1996.
- Long, A. A. 'Astrology: arguments pro and contra'. In *Science and Speculation: Studies in Hellenistic theory and practice*, edited by Jonathan Barnes, Jacques Brunschwig, Miles Burnyeat and Malcolm Schofield, 165–92. Cambridge: Cambridge University Press, 1982.
- Long, Christopher Philip. *The Ethics of Ontology: Rethinking an Aristotelian Legacy*. SUNY series in ancient Greek philosophy. Albany, NY: State University of New York Press, 2004.
- Lucarelli, Rita. 'Demonology during the Late Pharaonic and Greco-Roman Periods in Egypt'. *JANER* 11 (2011): 109–25.
- . 'Demons (benevolent and malevolent)'. In *UCLA Encyclopedia of Egyptology*, edited by Jacco Dieleman and Willeke Wendrich, 1–10. Los Angeles: Department of Near Eastern Languages and Cultures, UC Los Angeles, 2010.
- Luck, Georg. *Arcana Mundi: Magic and the Occult in the Greek and Roman Worlds*. Baltimore/London: Johns Hopkins University Press, 1985, repr. 1992.
- Macdonald, H. B., and H. Massé. 'Djinn'. In *The Encyclopaedia of Islam, New Edition*, vol. 11, 546–48. Leiden: E. J. Brill, 1965.
- MacKenzie, D. N. 'Zoroastrian Astrology in the "Bundahišn"'. *Bulletin of the School of Oriental and African Studies, University of London* 27, no. 3 (1964): 511–29.
- Mameli Lattanzi, Goffredo. *Il 'De Genio Socratis' di Plutarco*. Rome: Istituto Poligrafico dello Stato, 1933.
- Mastrocinque, Attilio. *From Jewish Magic to Gnosticism*. Vol. 24, Studien und Texte zu Antike und Christentum. Tübingen: Mohr Siebeck, 2005.
- McBride, Daniel Richard. 'The Egyptian Foundations of Gnostic Thought'. Ph.D. Thesis, University of Toronto, 1994.
- McKenzie, Judith. *The Architecture of Alexandria and Egypt 300 BC–AD 700*. Pelican History of Art. New Haven: Yale University Press, 2007.
- Mead, G. R. S. *Thrice Greatest Hermes: Studies in Hellenistic Theosophy and Gnosis, Being a Translation of the Extant Sermons and Fragments of the Trismegistic Literature with*

- Prolegomena Commentaries and Notes*. York Beach, ME: Samuel Weiser, 1906, repr. 1992.
- Meeks, Dimitri. 'Demons'. In *The Ancient Gods Speak*, edited by Donald B. Redford, 102–06. Oxford/New York: Oxford University Press, 2002.
- . 'Génies, Anges, Démons en Égypte'. In *Génies, anges et démons. Égypte, Babylone, Israël, Islam etc.*, 17–84. Paris: Éditions du Seuil, 1971.
- . 'Notion de « dieu » et structure du panthéon dans l'Égypte ancienne'. *RHR* 205, no. 4 (1988): 425–46.
- van der Meer, L. B. *The Bronze Liver of Piacenza: Analysis of a Polytheistic Structure*. Vol. 2, Dutch Monographs on Ancient History and Archaeology. Amsterdam: J.C. Gieben, 1987.
- . 'Iecur Placentinum and the Orientation of the Etruscan Haruspex'. *BABesch* 54 (1979): 49–58.
- Mendel, Daniela. *Die Monatsgöttinnen in Tempeln und im privaten Kult*. Vol. 11, Rites Égyptiens. Turnhout: Brepols, 2005.
- Mercatante, Anthony S. *Who's Who in Egyptian Mythology*. New York: Clarkson N. Potter, Inc., 1978.
- Merkelbach, Reinhold. *Isis regina—Zeus Sarapis. Die griechisch-ägyptische Religion nach den Quellen dargestellt*. Stuttgart/Leipzig: B. G. Teubner, 1995.
- Merlan, P. 'The Stoa'. In *The Cambridge History of Later Greek and Early Medieval Philosophy*, edited by A. H. Armstrong, 124–32. Cambridge: Cambridge University Press, 1967.
- Miosi, Frank T. 'God, Fate and Free Will in Egyptian Wisdom Literature'. In *Studies in Philology in Honour of Ronald James Williams: A Festschrift*, edited by Gerald E. Kadish and Geoffrey E. Freeman, 69–111. Vol. 3, SSEA Publications. Toronto: Benben Publications, 1982.
- Morenz, Siegfried. *Egyptian Religion*. Translated by Ann E. Keep. London: Methuen & Co. Ltd., 1973.
- Morenz, Siegfried, and Dieter Müller. *Untersuchungen zur Rolle des Schicksals in der ägyptischen Religion*. Abhandlungen der sächsischen Akademie der Wissenschaften zu Leipzig. Berlin: Akademie-Verlag, 1960.
- Morrison, John Sinclair. 'Parmenides and Er'. *JHS* 75 (1955): 59–68.
- Moyer, Ian S. *Egypt and the Limits of Hellenism*. Cambridge/New York: Cambridge University Press, 2011.
- Mulgan, Richard G. 'Lot as a Democratic Device of Selection'. *The Review of Politics* 46, no. 4 (1984): 539–60.
- Müller, Dieter. *Ägypten und die griechischen Isis-Aretologien*. Berlin: Akademie-Verlag, 1961.
- Naether, Franziska. *Die Sortes Astrampsychi. Problemlösungsstrategien durch Orakel im römischen Ägypten*. Vol. 3, Orientalische Religionen in der Antike. Tübingen: Mohr Siebeck, 2010.

- Naydler, Jeremy. *Temple of the Cosmos: The Ancient Egyptian Experience of the Sacred*. Rochester, VT: Inner Traditions, 1996.
- Neugebauer, O. 'The Egyptian "Decans"'. In *Vistas in Astronomy*, edited by A. Beer, 47–51. London/New York: Pergamon Press, 1955.
- Neugebauer, Otto. 'The Chronology of Vettius Valens' Anthologiae'. *HThR* 47, no. 1 (1954): 65–67.
- . *A History of Ancient Mathematical Astronomy*. 3 vols. Berlin/Heidelberg/New York: Springer-Verlag, 1975.
- Neugebauer, Otto, and Henry B. Van Hoesen. 'Astrological Papyri and Ostraca: Bibliographical Notes'. *PAPhS* 108, no. 2 (1964): 57–72.
- Nilsson, Martin. 'Schlangenstele des Zeus Ktesios'. *Athenische Mitteilungen* 33 (1908): 279–88.
- Nilsson, Martin P. *Greek Popular Religion*. New York: Columbia University Press, 1940.
- Nitzsche, Jane Chance. *The Genius Figure in Antiquity and the Middle Ages*. New York/London: Columbia University Press, 1975.
- Nock, Arthur Darby. 'Posidonius'. *JRS* 49 (1959): 1–15.
- Nowak, Herbert. *Zur Entwicklungsgeschichte des Begriffes Daimon: eine Untersuchung epigraphischer Zeugnisse vom 5. Jh. v. Chr. bis zum 5. Jh. n. Chr.* Bonn: Rheinische Friedrich-Wilhelms-Universität, 1960.
- Ogden, Daniel. *Drakōn: Dragon Myth and Serpent Cult in the Greek and Roman Worlds*. Oxford: Oxford University Press, 2013.
- Onians, Richard Broxton. *The Origins of European Thought about the Body, the Mind, the Soul, the World, Time and Fate*. Cambridge: Cambridge University Press, 1951, repr. 2000.
- Onuki, Takashi. *Gnosis und Stoa. Eine Untersuchung zum Apokryphon des Johannes*. Vol. 9, Novum testamentum et orbis antiquus. Göttingen: Universitätsverlag Freiburg Schweiz/Vandenhoeck & Ruprecht, 1989.
- Oppenheim, A. Leo. *Ancient Mesopotamia: Portrait of a Dead Civilization*. Chicago/London: University of Chicago Press, 1964.
- Packman, Zola M. 'Instructions for the Use of Planet Markers on a Horoscope Board'. *ZPE* 74 (1988): 85–95.
- Pallottino, Massimo. 'Deorum sedes'. In *Studi in onore di Aristide Calderini e Roberto Paribeni*, 223–34. Vol. 3, Milan: Ceschina, 1956–1957.
- Parker, Richard A. 'A horoscopic text in triplicate'. In *Grammata demotika: Festschrift für Erich Lüddeckens zum 15. Juni 1983*, edited by Heinz-J Thissen and Karl-Th. Zauzich, 141–43. Würzburg: Gisela Zauzich, 1984.
- Parry, Hugh. 'The Homeric Hymn to Aphrodite: Erotic Ananke'. *Phoenix* 40 (1986): 253–64.
- Pearson, Birger A. *Ancient Gnosticism: Traditions and Literature*. Minneapolis: Fortress Press, 2007.

- Pellegrini, Guido. 'Le configurazioni planetarie e la nascita di Rāma: una comunicazione de G. V. Schiaparelli ad A. Weber'. In *Giovanni Schiaparelli: storico della astronomia e uomo di cultura. Atti del Seminario di studi organizzato dall'Istituto Italiano per l'Africa e l'Oriente e dall'Istituto di Fisica Generale Applicata dell'Università degli Studi di Milano. Milano, 12–13 Maggio 1997, Osservatorio Astronomico di Brera*, edited by Antonio Panaino and Guido Pellegrini, 151–67. Milan: Mimesis—Istituto italiano per l'Africa e l'Oriente, 1999.
- Pérez Jiménez, Aurelio. 'Elementi astrali nei miti di Plutarco'. In *Plutarco e la religione. Atti del VI Convegno plutarco (Ravello, 29–31 maggio 1995)*, edited by Italo Gallo, 297–309. Naples: M. D'Auria Editore, 1996.
- . 'Hephaestio and the Consecration of Statues'. *Culture and Cosmos* 11, no. 1 and 2 (2007): 111–34.
- . 'Περὶ δειπνοῦ. A propósito de Heph., 111 36'. *MHNH* 2 (2002): 237–53.
- Pétrément, Simone. *Le Dieu séparé: les origines du gnosticisme*. Paris: Éditions du Cerf, 1984.
- . 'Le mythe des sept archontes créateurs peut-il s'expliquer à partir du christianisme?' In *Le origini dello Gnosticismo. Colloquio di Messina 13–18 aprile 1966*, edited by Ugo Bianchi, 460–87. Leiden: E. J. Brill, 1967.
- Pietrzykowski, Michal. 'Sarapis—Agathos Daimon'. In *Hommages à Maarten J. Vermaseren*, edited by Margreet B. de Boer and T. A. Eldridge, 959–66. Vol. 111, Leiden: E. J. Brill, 1978.
- Pinch, Geraldine. *Magic in Ancient Egypt*. Austin: University of Texas Press, 1995.
- Pingree, David. 'Abū Ma'shar Al-Balkhī, Ja'far ibn Muhammad'. In *Dictionary of Scientific Biography*, edited by Charles Coulston Gillespie, 32–39. Vol. 1, New York: Scribner, 1970.
- . 'From Alexandria to Baghdād to Byzantium. The Transmission of Astrology'. *IJCT* 8, no. 1 (2001): 3–37.
- . 'Antiochus and Rhetorius'. *CPh* 72, no. 3 (1977): 203–23.
- . *From Astral Omens to Astrology: From Babylon to Bīkāner*. Rome: Istituto italiano per l'Africa e l'Oriente, 1997.
- . 'Classical and Byzantine Astrology in Sassanian Persia'. *DOP* 43 (1989): 227–39.
- . 'The Indian Iconography of the Decans and Horās'. *Journal of the Warburg and Courtauld Institutes* 26, no. 3/4 (1963): 223–54.
- . 'Indian Influence on Sasanian and Early Islamic Astronomy and Astrology'. *Journal of Oriental Research (Madras)* 34–35 (1964–65): 118–26.
- . 'Māshā'allāh: Some Sasanian and Syriac Sources'. In *Essays on Islamic Philosophy and Science*, edited by George F. Hourani, 5–14. Albany: State University of New York Press, 1975.
- Pleše, Zlatko. 'Fate, Providence and Astrology in Gnosticism (I): The Apocryphon of John'. *MHNH* 7 (2007): 237–68.

- . 'Gnostic Dualism'. In *Light Against Darkness: Dualism in Ancient Mediterranean Religion and the Contemporary World*, edited by Armin Lange, Eric M. Meyers, Bennie H. Reynolds III and Randall Styers, 209–25. Göttingen: Vandenhoeck and Ruprecht, 2011.
- . *Poetics of the Gnostic Universe: Narrative and Cosmology in the Apocryphon of John*. Vol. 52, Nag Hammadi and Manichaean Studies. Leiden: Brill, 2006.
- Popović, Mladen. *Reading the Human Body: Physiognomics and Astrology in the Dead Sea Scrolls and Hellenistic-Early Roman Period Judaism*. Vol. 67, Studies on the Texts of the Desert of Judah. Leiden/Boston: Brill, 2007.
- Posener, Georges. 'On the Tale of the Doomed Prince'. *JEA* 39 (1953): 107.
- Preisendanz, Karl. 'Review of "Wilhelm Gundel, Dekane und Dekansterbilder"'. *GGA* 201 (1939): 129–49.
- Quack, J. F. 'The Naos of the Decades and its Place in Egyptian Astrology'. In *Alexandria and the North-Western Delta: Joint Conference Proceedings of Alexandria: City and Harbour (Oxford 2004) and The Trade and Topography of Egypt's North-West Delta (Berlin 2006)*, edited by Damian Robinson and Andrew Wilson, 175–81. Oxford: Oxford Centre for Maritime Archaeology, Institute of Archaeology, 2010.
- Quack, Joachim Friedrich. 'Zu einer angeblich apokalyptischen Passage in den Ostraka des Hor'. In *Apokalyptik und Ägypten. Eine kritische Analyse der relevanten Texte aus dem griechisch-römischen Ägypten*, edited by A. Blasius and B. U. Schipper, 243–52. Leuven/Paris/Sterling, VA: Peeters, 2002.
- . 'Beiträgen zu den ägyptischen Dekanen und ihrer Rezeption in der griechisch-römischen Welt'. Habilitationsschrift, Freie Universität Berlin, 2003. Revised version, August 2014. Publication forthcoming.
- . 'Dekane und Gliedervergottung. Altägyptische Traditionen im Apokryphon Johannis'. *JbAC* 38 (1995): 97–122.
- . 'Frühe ägyptische Vorläufer der Paranatellonta?' *SA* 83 (1999): 212–23.
- . "'Ich bin Isis, die Herrin der beiden Länder" Versuch zum demotischen Hintergrund der memphitischen Isisaretalogie'. In *Egypt—Temple of the Whole World. Ägypten—Tempel der gesamten Welt. Studies in Honour of Jan Assmann*, edited by Sibylle Meyer, 319–65. Leiden/Boston: Brill, 2003.
- . 'Les Mages Égyptianisés? Remarks on Some Surprising Points in Supposedly Magusean Texts'. *JNES* 65, no. 4 (2006): 267–82.
- . 'Die Spur des Magiers Petese'. *Cd'É* 77 (2002): 76–92.
- Quaegebeur, Jan. *Le dieu égyptien Shaï dans la religion et l'ononastique*. Vol. 2, Orientalia Lovaniensia Analecta. Leuven: Leuven University Press, 1975.
- Raffaelli, Enrico G. *L'oroscopo del mondo: Il tema di nascita del mondo e del primo uomo secondo l'astrologia zoroastriana*. Milan: Mimesis, 2001.
- Raffaelli, Enrico Giuseppe. 'Il tema del mondo e il tema del Gayomard nel Bundahišn'. In *Giovanni Schiaparelli: storico della astronomia e uomo di cultura. Atti del Seminario*

- di studi organizzato dall'Istituto Italiano per l'Africa e l'Oriente e dall'Istituto di Fisica Generale Applicata dell'Università degli Studi di Milano. Milano, 12–13 Maggio 1997, Osservatorio Astronomico di Brera, edited by Antonio Panaino and Guido Pellegrini, 187–93. Milan: Mimesis—Istituto italiano per l'Africa e l'Oriente, 1999.*
- Rasimus, Tuomas. *Paradise Reconsidered in Gnostic Mythmaking: Rethinking Sethianism in Light of the Ophite Evidence*. Leiden/Boston: Brill, 2009.
- Redford, Donald B., ed. *The Ancient Gods Speak: A Guide to Egyptian Religion*. Oxford/New York: Oxford University Press, 2002.
- Reed, Annette Yoshiko. *Fallen Angels and the History of Judaism and Christianity: The Reception of Enochic Literature*. Cambridge: Cambridge University Press, 2005.
- Reitzenstein, Richard. *Poimandres: Studien zur griechisch-ägyptischen und frühchristlichen Literatur*. Leipzig: Teubner, 1904.
- Riley, Mark. 'A Survey of Vettius Valens'. 1996. Electronic Article, http://www.csus.edu/indiv/r/rileymt/PDF_folder/VettiusValens.PDF. At <http://www.csus.edu/indiv/r/rileymt/>.
- . 'Theoretical and Practical Astrology: Ptolemy and his Colleagues'. *TAPhA* 117 (1987): 235–56.
- Rist, J. M. *Stoic Philosophy*. Cambridge: Cambridge University Press, 1969, repr. 1980.
- Ritner, Robert K. 'Egyptian Magical Practice under the Roman Empire: the Demotic Spells and their Religious Context'. In *ANRW*, edited by Wolfgang Haase, 3333–79. Vol. 11, 18.5, Berlin/New York: Walter de Gruyter, 1995.
- Rochberg, Francesca. *The Heavenly Writing: Divination, Horoscopy, and Astronomy in Mesopotamian Culture*. Cambridge: Cambridge University Press, 2004.
- Rochberg-Halton, Francesca. 'Elements of the Babylonian Contribution to Hellenistic Astrology'. *JAOS* 108, no. 1 (1988): 51–62.
- . 'Fate and Divination in Mesopotamia'. *AOF Beiheft* 19, no. 28. Rencontre Assyriologique Internationale in Wien. 6–10 Juli 1981 (1982): 363–71.
- Rohde, Erwin. *Psyche: The Cult of Souls and Belief in Immortality among the Greeks*. London: Kegan Paul, Trench, Trubner & Co., Ltd., 1925.
- Rose, Herbert Jennings. 'Nvmen inest: "Animism" in Greek and Roman Religion'. *HTHR* 28, no. 4 (1935): 237–57.
- Rosenstein, Nathan. 'Sorting out the Lot in Republican Rome'. *AJPh* 116, no. 1 (1995): 43–75.
- Ross, Micah T. 'A Survey of Demotic Astrological Texts'. *Culture and Cosmos* 11 (2007): 1–25.
- Rudolph, Kurt. *Gnosis: The Nature and History of Gnosticism*. Translated by R. McL. Wilson, P. W. Coxon and K. H. Kuhn. San Francisco: HarperCollins, 1987.
- Russell, Jeffrey Burton. *The Devil: Perceptions of Evil from Antiquity to Primitive Christianity*. Ithaca/London: Cornell University Press, 1977.

- Saggs, Henry William Frederick. *The Encounter with the Divine in Mesopotamia and Israel*. London: University of London – Athlone Press, 1978.
- . *The Greatness that was Babylon*. London: Sidgwick and Jackson, 1962.
- Sauneron, Serge. 'La conception égyptienne du bonheur. À propos des "Quatre Ka" (Esna 319)'. *BIFAO* 57 (1958): 163–64.
- Schaefer, H. W. 'Achilleus Tatios [2]'. In *Paulys Realencyclopädie der Classischen Altertumswissenschaft*, Band I.1, cols 247–48. Stuttgart: J. B. Metzler, 1894.
- Schaper, Joachim. 'God and the Gods: Pagan Deities and Religious Concepts in the Old Greek of Isaiah'. In *Genesis, Isaiah and Psalms: A Festschrift to Honour Professor John Emerton for his Eightieth Birthday*, edited by Katharine Dell, Graham Davies and Yee Von Koh, 135–52. Leiden: Brill, 2010.
- Schibli, Hermann S. 'Xenocrates' Daemons and the Irrational Soul'. *CQ New Series*, 43, no. 1 (1993): 143–67.
- Schmidt, Francis. 'Horoscope, Predestination and Merit in Ancient Judaism'. *Culture and Cosmos* 11, no. 1 and 2 (2007): 27–41.
- Schmidt, John D. *Ramesses II: A Chronological Structure for His Reign*. The Johns Hopkins Near Eastern Studies. Baltimore/London: The Johns Hopkins University Press, 1973.
- Schmidt, Robert. 'Facets of Fate'. *The Mountain Astrologer* (Dec.–Jan. 1999–2000): 83–94, 106, 126.
- Schrekenberg, Heinz. *Ananke: Untersuchungen zur Geschichte des Wortgebrauchs*. Heft 36, Zetemata Monographien zur klassischen Altertumswissenschaft. Munich: Beck, 1964.
- Seeligmann, I. L. *The Septuagint Version of Isaiah: A Discussion of its Problems*. Leiden: E. J. Brill, 1948. Reprint, Tübingen: Mohr Siebeck, 2004.
- Setaioli, Aldo. 'The *Daimon* in Timarchus' Cosmic Vision (Plu. *De Gen. Socr.* 22, 590B–592E)'. In *Nomos, Dike and Cosmos in Plutarch*, edited by José Ribeiro Ferreira, Delfim F. Leão and Carlos A. Martins de Jesus, 109–19. Coimbra: Centro de Estudos Clássicos e Humanísticos da Universidade de Coimbra, 2012.
- Sfameni Gasparro, Giulia. '*Daimôn* and *Tuchê* in the Hellenistic Religious Experience'. In *Conventional Values of the Hellenistic Greeks*, edited by Per Bilde, Troels Engberg-Pedersen, Lise Hannestad and Jan Zahle, 67–109. Aarhus: Aarhus University Press, 1997.
- . 'The Hellenistic Face of Isis: Cosmic and Saviour Goddess'. In *Nile into Tiber: Egypt in the Roman World*, edited by Laurent Bricault, Miguel John Versluys and Paul G. P. Meyboom, 40–72. Leiden/Boston: Brill, 2007.
- . 'Magie et démonologie dans les *Papyrus Graecae Magicae*'. *Res Orientales* 13 (*Démons et merveilles d'Orient*) (2001): 157–74.
- Shanzer, Danuta. *A Philosophical and Literary Commentary on Martianus Capella's De Nuptiis Philologiae et Mercurii Book 1*. University of California: Classical Studies. Berkeley/Los Angeles: University of California Press, 1986.

- Sharples, Robert W. 'Threefold Providence: The History and Background of a Doctrine'. In *Ancient Approaches to Plato's 'Timaeus'*, 107–27. London: *BICS* Supplement 78, 2003.
- Shaw, Gregory. *Theurgy and the Soul: The Neoplatonism of Iamblichus*. University Park, PA: The Pennsylvania State University Press, 1995.
- . 'Theurgy: Rituals of Unification in the Neoplatonism of Iamblichus'. *Traditio* 41 (1985): 1–28.
- Shorey, Paul. 'Τύχη in Polybius'. *CPh* 16, no. 3 (1921): 280–83.
- Skovgaard Jensen, Søren. *Dualism and Demonology: The Function of Demonology in Pythagorean and Platonic Thought*. Copenhagen: Munksgaard, 1966.
- Smith, Amy C. 'Athenian Political Art from the Fifth and Fourth Centuries BCE: Images of Political Personifications'. *Dēmos: Classical Athenian Democracy*, ed. Christopher W. Blackwell, edition 18 January 2003 (A. Mahoney and R. Scaife, eds, *The Stoa: a consortium for electronic publication in the humanities* [<http://www.stoa.org>]). 1–26.
- Smith, Andrew. 'Porphyrian Studies Since 1913'. In *ANRW*, edited by Wolfgang Haase, 717–73. Vol. 11.36.2, Berlin/New York: Walter de Gruyter, 1987.
- . *Porphyry's Place in the Neoplatonic Tradition: A Study in Post-Plotinian Neoplatonism*. The Hague: Martinus Nijhoff, 1974.
- . 'Porphyry—Scope for a Reassessment'. In *Studies on Porphyry*, edited by George Karamanolis and Anne Sheppard, 7–16. London: *BICS* Supplement 98, 2007.
- Smith, Mark. *On the Primaeval Ocean*. Vol. 5, The Carlsberg Papyri. Copenhagen: CNI Publications, 2002.
- Smith, Morton. 'The Demons of Magic'. Paper presented at the Philadelphia Seminar on Christian Origins, Philadelphia, PA, 5 May 1988, online at <http://ccat.sas.upenn.edu/psco/year25/8805.shtml>.
- Smith, Morton Q. 'The Eighth Book of Moses and How It Grew (PLeid. J 395)'. In *Atti del XVII congresso internazionale di papirologia*, edited by Marcello Gigante, 683–93. Naples: Centro internazionale per lo studio dei ercolanesi, 1984. Reprint, in *Studies in the Cult of Yahweh*, ed. Shaye J. D. Cohen, 217–26. Leiden: E. J. Brill, 1996.
- Smith, Rowland. *Julian's Gods: Religion and Philosophy in the Thought of Julian the Apostate*. London/New York: Routledge, 1995.
- Sorabji, Richard. *Necessity, Cause and Blame: Perspectives on Aristotle's Theory*. London: Duckworth, 1980.
- Sorensen, Eric. *Possession and Exorcism in the New Testament and Early Christianity*. Tübingen: Mohr Siebeck, 2002.
- Soury, Guy. *La démonologie de Plutarque: essai sur les idées religieuses et les mythes d'un platonicien éclectique*. Paris: Les Belles Lettres, 1942.
- Spiegelberg, Wilhelm. 'Die ägyptischen Namen und Zeichen der Tierkreisbilder in demotischer Schrift'. *ZAS* 48 (1910): 146–51.

- Staden, Heinrich von. 'Galen's daimon: reflections on « irrational » and « rational »'. In *Rationnel et irrationnel dans la médecine ancienne et médiévale: aspects historiques, scientifiques et culturels*, edited by Nicoletta Palmieri, 15–43. Saint-Étienne: Publications de l'Université de Saint-Étienne, 2003.
- Stoll, Oliver. 'The Religions of the Armies'. In *A Companion to the Roman Army*, edited by Paul Erdkamp, 451–76. Oxford/Malden, MA: Blackwell Publishing Ltd., 2007.
- Struck, Peter. 'A World full of Signs: Understanding Divination in Ancient Stoicism'. In *Seeing with Different Eyes: Essays in Astrology and Divination*, edited by Patrick Curry and Angela Voss, 3–20. Newcastle: Cambridge Scholars Publishing, 2007.
- von Stuckrad, Kocku. *Das Ringen um die Astrologie: jüdische und christliche Beiträge zum antiken Zeitverständnis*. Band 49, Religionsgeschichtliche Versuche und Vorarbeiten. Berlin/New York: Walter de Gruyter, 2000.
- . 'Jewish and Christian Astrology in Late Antiquity—A New Approach'. *Numen* 47 (2000): 1–40.
- Sullivan, Richard D. 'The Dynasty of Commagene'. In *ANRW*, edited by Hildegard Temporini and Wolfgang Haase, 732–98. Vol. 11.8, Berlin/New York: Walter de Gruyter, 1977.
- Swain, Simon. 'Plutarch: Chance, Providence and History'. *AJPh* 110, no. 2 (1989): 272–302.
- Tharón, Leonardo. *Academica: Plato, Philip of Opus, and the Pseudo-Platonic Epinomis*. Vol. 7, Memoirs of the American Philosophical Society. Philadelphia: American Philosophical Society, 1975.
- Tardieu, Michel. *Trois mythes gnostiques. Adam, Éros et les animaux d'Égypte dans un écrit de Nag Hammadi (II, 5)*. Paris: Études Augustiniennes, 1974.
- Taylor, A. E. *A Commentary on Plato's Timaeus*. Oxford: Clarendon Press, 1928.
- Tester, Jim. *A History of Western Astrology*. Woodbridge, Suffolk: The Boydell Press, 1987, repr. 1996.
- Thausing, Gertrud. 'Der ägyptische Schicksalsbegriff'. *MDAIK* 8 (1939): 46–70.
- Theiler, Willy. 'Tacitus und die antike Schicksalslehre'. In *Forschungen zum Neuplatonismus*, 46–103. Berlin: Walter de Gruyter, 1966.
- Thissen, Heinz J. 'ΚΜΗΦ—Ein verkannter Gott'. *ZPE* 112 (1996): 153–60.
- Thomann, Johannes. 'Square Horoscope Diagrams in Middle Eastern Astrology and Chinese Cosmological Diagrams: Were These Designs Transmitted through the Silk Road?'. In *The Journey of Maps and Images on the Silk Road*, edited by Philippe Forêt and Andreas Kaplony, 97–118. Leiden/Boston: Brill, 2008.
- Thomson, George. 'From Religion to Philosophy'. *JHS* 73 (1953): 77–83.
- Thorndike, Lynn. 'Traditional Medieval Tracts Concerning Engraved Astrological Images'. In *Mélanges Auguste Pelzer*, 217–74. Louvain: Bibliothèque de l'Université, Bureaux du 'Recueil', 1947.

- Thulin, Carl. *Die götter des Martianus Capella und der bronzeleber von Piacenza*. Vol. 3.1, Religionsgeschichtliche Versuche und Vorarbeiten. Giessen: A. Töpelmann, 1906.
- Timotin, Andrei. 'Éros, le démon philosophe et la polémique anti-gnostique. Plotin lecteur du *Banquet*'. In *De Socrate à Tintin. Anges gardiens et démons familiers de l'Antiquité à nos jours*, edited by Jean-Patrice Boudet, Philippe Faure and Christian Renoux, 51–65. Rennes: Presses universitaires de Rennes, 2011.
- . *La démonologie platonicienne*. Vol. 128, Philosophia Antiqua. Leiden/Boston: Brill, 2012.
- van der Toorn, Karel, Bob Becking, and Pieter Willem van der Horst, eds. *Dictionary of Deities and Demons in the Bible*. 2nd rev. ed. Leiden/Boston/Grand Rapids, MI: Brill; Eerdmans, 1999.
- Torijano, Pablo A. *Solomon the Esoteric King: From King to Magus, Development of a Tradition*. Vol. 73, Supplements to the Journal for the Study of Judaism. Leiden/Boston: Brill, 2002.
- Trapp, Michael B. 'On the *Tablet of Cebes*'. In *Aristotle and After*, edited by Richard Sorabji, 159–80. London: *BICS* Supplement 68, 1997.
- Ulansey, David. *The Origins of the Mithraic Mysteries: Cosmology and Salvation in the Ancient World*. Oxford: Oxford University Press, 1991 (rev.).
- Vermaseren, M. J. 'The Miraculous Birth of Mithras'. *Mnemosyne* 4, no. 3/4 (1951): 285–301.
- Vernière, Yvonne. *Symboles et mythes dans la pensée de Plutarque*. Paris: Belles Lettres, 1977.
- Versnel, H. S. *Inconsistences in Greek and Roman Religion I. Ter Unus: Isis, Dionysos, Hermes: Three Studies in Henotheism*. Vol. 6, Studies in Greek and Roman Religion. Leiden/New York/Copenhagen: E. J. Brill, 1990.
- Visser, Cornelia Elizabeth. *Götter und Kulte im ptolemäischen Alexandrien*. Amsterdam: N. v. noord-hollandsche uitgevers-mij, 1938.
- van der Vliet, Jacques. 'Fate, Magic and Astrology in *Pistis Sophia*, Chaps 15–21'. In *The Wisdom of Egypt: Jewish, Early Christian and Gnostic Essays in Honour of Gerard P. Luttikhuisen*, edited by Anthony Hilhorst and George van Kooten, 519–36. Leiden/Boston: Brill, 2005.
- Vogt, Joseph. *Die alexandrinischen Münzen. Grundlegung einer alexandrinischen Kaisergeschichte*. 2 vols in 1. Stuttgart: W. Kohlhammer Verlag, 1924.
- Volk, Katharina. *Manilius and his Intellectual Background*. Oxford: Oxford University Press, 2009.
- van der Waerden, B. L. 'Babylonian Astronomy. II. The Thirty-Six Stars'. *Journal of Near Eastern Studies* 8, no. 1 (1949): 6–26.
- Waterfield, Robin. 'The Evidence for Astrology in Classical Greece'. *Culture and Cosmos* 3.2 (1999): 3–15.

- Weinstock, Stefan. 'Lunar Mansions and Early Calendars'. *JHS* 69 (1949): 48–69.
- . 'Martianus Capella and the Cosmic System of the Etruscans'. *JRS* 36.1 and 2 (1946): 101–29.
- Welburn, Andrew J. 'The Identity of the Archons in the "Apocryphon Johannis"'. *VChr* 32, no. 4 (1978): 241–54.
- . 'Reconstructing the Ophite Diagram'. *NT* 23, no. 3 (1981): 261–87.
- Wenning, Robert. 'The Message of the Khirbat at-Tannūr Reliefs'. *Studies in the History and Archaeology of Jordan* 10 (2009): 577–84.
- West, Martin Litchfield. *Early Greek Philosophy and the Orient*. Oxford: Clarendon Press, 1971.
- . *The Orphic Poems*. Oxford: Oxford University Press, 1983, repr. 1984.
- Winkler, Andreas. 'Looking at the Future: Divination and Astrology in Ancient Egypt'. Ph.D. Thesis, Uppsala University, 2011.
- Witte, Bernd. *Das Ophiten-diagramm nach Origenes' Contra Celsum VI 22–38*. Vol. 6, Arbeiten zum spätantiken und koptischen Ägypten. Altenberge: Oros Verlag, 1993.
- Zandee, Jan. *Death as an Enemy according to Ancient Egyptian Conceptions*. Leiden: E. J. Brill, 1960.
- Zauzich, Karl-Theodor. 'Die demotischen Orakelfragen—eine Zwischenbilanz'. In *A Miscellany of Demotic Texts and Studies (The Carlsberg Papyri 3)*, edited by P. J. Frandsen and Kim Ryholt, 1–25, Pls. 1–3. Vol. 22, CNI Publications. Copenhagen: Museum Tusulanum Press, 2000.
- Ziegler, Konrat. 'Plutarchos, II 3, Chronologie'. In *Paulys Realencyclopädie der Classischen Altertumswissenschaft*, Zweite Reihe, Band XXI.1. Stuttgart: Metzler, 1951.

General Index

- Abiressia. *See* angels, Gnostic, Abrisene
Abiresine. *See* angels, Gnostic, Abrisene
Abraham (astrologer) 312
Abu Jandir, Egypt. *See* Medīnet Mâdi
Abū Ma'shar 231, 257, 366
 Abbreviation of the Introduction to Astrology 365, 377, 387
 De revolutionibus nativitatum 367, 375–76, 378, 476, 480, 481–82
 Great Introduction/Greater Introduction 313, 365, 387, 475
 lots and 376–78, 387, 475–76
Abydos 96, 98n93, 351n57
Achilles (astronomer?) 461–62
Achilles Staius. *See* Achilles Tatius
Achilles Tatius 462
Acropolis 48, 381
Adonaeus. *See* archons, Adonaios
Adonai. *See* archons, Adonaios
Adoni. *See* archons, Adonin
Adrasteia 344, 351–52, 354, 379
aeons 163, 174, 179–80
Aeschylus 20, 122, 125
 Prometheus Bound 91, 345
Aesculapius. *See* Asclepius
Agathe Tyche (deity). *See also* Tyche;
 good fortune 11, 47, 101
 cultural pair with Agathos Daimon 46–49, 52, 76–77, 82, 300, 390
 fortune and 88
 Isis and 47, 77–82, 86, 88, 91, 94–95, 390
 Renenet and 79–80, 101–02, 390
 Shepset and 102
 snakes and 79
Agathos Daimon (deity). *See also* good daimon
 aither and 204
 Bible and 130
 caduceus and 81, 86, 340n5
 coins to 79–81, 86
 cultural pair with Agathe Tyche 46–49, 52, 76–77, 82, 300, 390
 fate and 47, 85, 90, 95, 107, 112, 207
 Greek version of 46–49, 58, 82–85
 in Magical Papyri 9, 195–200, 204–07
 Potter's Oracle and 79, 83–84
 Sarapis and 47, 77–80, 94–95, 101, 203, 390
 Shai and 11, 77, 79–85, 95, 98, 100–01, 107, 205–07, 219, 315, 391
 shrines/altars to 79–82
 snakes and 52, 79, 83, 85, 206
 sun and 9, 198–200, 204–6
 Zarathustra and 161–62
 Zeus and 50–52, 293
Ahriman 125, 161–62
Ahura Mazda 161–62, 351
Aidoneus. *See* Hades
Ailoaios. *See* archons, Eloaios
Aither (Orphic deity) 351
akh (spirit). *See also* *ʔh.w* 218
Akhenaten 104–05
Akressina. *See* angels, Gnostic, Abrisene
alastor 122
al-Birūni 366, 387
 The Book of Instruction in the Elements of the Art of Astrology 365
alchemy 139, 392
alcocoden. *See also* kadhkhudāh 259
Alexander of Aphrodisias
 De anima 269
 On Fate 49
Alexander the Great 46, 78, 80, 85
Alexandria 47, 77–86, 94, 129n75, 300, 436
 Sarapeum at 79
 Tychaion at 82
Allāt 94
al-mubtazz. *See* almuten
almuten 260, 272, 435, 438
Al-Qabīṣī
 The Introduction to Astrology 223, 226, 313, 365
Amesha Spentas 161
amulet 117–18, 219
Amun 78, 84n33, 105, 115, 217, 351n57
anairētēs (destroyer) 257
Ananke, Necessity (deity/daimon). *See also* necessity, *anankē*; Ἀνάγκη; ἀνάγκη,
 ἀναγκαιός 36, 143, 233–34, 300, 341–47, 349, 383
Adrasteia and 344, 351, 354n76, 379n148
Chronos/Herakles and 353–55
Fate and 274, 345, 347, 349–50, 382

- Hermes/Mercury and 234, 299, 353, 359,
456–57
in Macrobius 340–41, 380, 386
knot of 340, 355, 380, 386
Myth of Er and 282–84, 344, 347, 355,
379, 383, 386n175, 394, 413n33
Orphic 344–45, 350, 352–53, 379,
386n175, 388
pair with Eros 339, 346, 349–50, 379–81,
383, 386, 388
anankē. See necessity, *anankē*
Andros 87, 380
angels 124, 131–32, 136–37, 171, 194–95, 201,
222, 238, 247
Gnostic 164, 174, 179. See also aeons;
authorities (*exousiai*)
Abel 175–77
Abrisene 175
Adonaios 174–75
Adonin. See also archons, Adonin 175
Athoth. See also archons, Athoth
174–78
moon and 177–78
Belias 174–75, 177–78
Galila 174–75
Harmas 174
Harmoupiel 175
Kain 174–75
Yobel 174–75
zodiac and 164, 174–79
Antigonus of Nicaea 112, 230, 257–58,
429–32
Antiochus Epiphanes Philopappus, C. Julius
184
Antiochus Epiphanes, C. Julius 184
Antiochus IV, C. Julius (of Commagene) 184
Antiochus of Athens 17, 65
and Porphyry 65, 188, 256n86, 264,
267–71, 439–41
on astrological places 65, 143
on decans 226–27
on lots 288, 309–11, 314
on the *oikodespotēs* 257–58
on planets 148
possible heritage of 183–84
Thema dei and 187–90, 192
Thema mundi and 184–85, 187–90, 192
antiscia 93, 404
Anu 280
Anu-bēlšunu
chart of 307
Anubio (astrological poet) 112, 186, 251
on astrological places 72–73
on decans 227–29
Anubis 207
aphesis (releasing) 321–23, 335, 388, 393,
470
aphetēs (releaser), *apheta*. See also *dator vitae*
107, 258, 260, 264–65, 321, 331, 412
description of 107–08
Aphrodite/Venus 34–35, 50, 56–58, 60–62,
67, 70–74, 78, 88, 111–12, 134, 136n113,
146, 148, 168–70, 172, 174–75, 180, 183,
187, 190, 234, 241, 256, 259n97, 297–99,
315, 319, 322n61, 325–27, 329, 342–44,
348–49, 352n61, 356–59, 361, 365, 367,
369–70, 373–74, 376, 381, 384, 387, 399,
403–04, 407–09, 417, 419, 423–26,
429–32, 434–38, 447, 456–57, 470–71,
476, 479–82
Apis bull 78
Apophis 120
Apuleius
daimon and 18, 237
De deo Socratis 22, 49
De Platone 29, 31, 49
fate and 28–29
Metamorphoses 91, 105, 106
Aratus
Phaenomena 355
archangels 179, 222
Archir-Adonin. See angels, Gnostic, Adonin
Archive of Ḥor 53, 88–89, 102
archons 162–69, 171–74, 177, 179–80
Adonaios 166–67, 170–72, 174–75
Adonin. See also angels, Gnostic, Adonin
166, 172
Astaphaios 166–67, 169–72
Athoth 166, 171–72
moon and 172, 177–78
Eloaios 166–67, 169–70, 172
Ialdabaoth 164–67, 170–71
Iao 161, 165–66, 169–72, 178
Sun and 165, 169–70, 172
Oraios 166–67, 170–71
planets as 162–65, 167
Sabaoth 163, 166, 170–72, 174, 180
Sabbataios 166, 171–72

- Ares/Mars 58n54, 60n70, 67, 70, 72, 74–75, 108, 127, 134, 142, 146, 148–51, 153–54, 168–70, 172, 174–75, 180, 183–84n114, 187, 190, 223, 232, 234, 241n27, 245, 256, 259, 295, 297–99, 315, 319–20, 322, 325–26, 329, 357, 367, 369–71, 376, 387n178, 399, 403–04, 407–09, 419, 423–24, 429–34, 437, 447, 453, 456–57, 469–71, 480–81
- Arians 161
- Aristophanes 353
The Birds 352
- Aristotle 23
Eudemian Ethics 20
Nicomachean Ethics 20
On Generation and Corruption 133
Physics 383
Prior Analytics 44
The Athenian Constitution 281
- Armoupieel. *See* angels, Gnostic, Harmoupieael
- Artemidorus
Oneirocritica 78
- Artemis 87, 473
- Ascendant (rising degree). *See also* places, astrological, 1st place; ὠροσκόπος 34, 42, 45, 65, 108, 147, 149, 192n134, 205, 210–11, 227–30, 234–35, 255, 260, 263–66, 271–72, 285, 287, 289–91, 300–01, 307–10, 314–15, 317, 319–20, 325, 327–38, 346, 361, 363–64, 368–69, 371–74, 376–78, 393–94, 400, 411, 413, 424–25, 427, 429, 431–32, 434–35, 437–38, 440–41, 443–44, 447, 454, 456, 479, 481–82
- 'Asclepius' (astrologer) 65, 186
- Asclepius (deity) 78, 233
connection with Imhotep 207
- Astaphaeus. *See* archons, Astaphaius
- Astarte 87
- astrology
as fatalistic 3, 114, 179, 238, 395
as non-fatalistic 204, 391–92, 395
- Babylonian 307
- Demotic 53–57, 61–62, 102–03, 120, 141, 218, 307, 314–17
- description of western Hellenistic 5–6
- Egyptian concept of 103–07
- Jewish 106, 131–34, 136
- fate and length of life 106
- theory and philosophy of Hellenistic 6
- theurgy and 3, 247–49, 253, 275, 394
- western origins of 5
- Asyut 214
- Aten 104
- Athenagoras 353, 385
Plea for the Christians 354
- Atlas 342
- 'Atrahasis' (The Flood) 280
- Atropos. *See also* Moirai 25, 27, 30, 283, 396
- Atum 198, 199
- augury 56–57, 131
- Augustus 279
- authorities (*exousiai*) 174–76, 177, 179–80, 251
- ba* (soul/personality) 96–97, 218
- bad daimon, evil daimon. *See also* demon
4–6, 19, 47, 61, 116, 124, 126, 142, 155, 159–65, 184, 194–95, 209, 237, 242–43, 284
called *daimonion* 137–40
Christian/in Christianity 10, 12
Egyptian 12, 121
Greek 12, 122–24
illness and 127, 140, 314
in *Testament of Solomon* 132–33, 222
in the Chaldean Oracles 125–26, 163, 165
Jewish/in Judaism 10, 12
Mesopotamian 12, 116–19
passions and 142, 150, 212, 392
- bad fortune. *See also* fortune (*tuchē*) 47, 49, 112, 141, 143, 188, 228, 283, 368, 419, 452–53, 465–66
- Balbillus, T. Claudius 183–84, 279
- Bastet 217
- bayt* (house) 64
- Belial. *See* angels, Gnostic, Belias
- Beliar. *See* angels, Gnostic, Belias
- Bentresh Stela 131
- Bible
Apocrypha
Baruch 128
New Testament
Luke 137
Mark 137
Matthew 137, 255
Old Testament
Deuteronomy 128

- Habbakuk 128
 Isaiah 129, 390
 Psalms 128, 129, 130
- boards, astrological. *See also pinax*
 (astrological board)
 Daessy Table 205, 235
 Kharga Oasis glass disc 235
 Tablettes de Grand (Grand Tablets) 235
 Egyptian connections of 173
 illness and 214
 Tabula Bianchini 235
 Tanis Zodiac 235
- Bona Fortuna. *See* Agathe Tyche (deity)
- Bonatti, Guido 262, 365, 387
De astronomia 365
- Bonincontri, Laurentius 58, 415
Book of Enoch 131, 139
Astronomical Book 131–32
Book of the Watchers 131, 137, 139
Book of the Dead (Book of Going Forth by Day)
 96–97
- Brummer Amulet 165–67, 170–71
- caduceus 351
 Agathos Daimon and 81, 86, 340n5
 Ananke/Necessity and 340, 380, 386
 astrological connections 384, 386–88
 birth and 340, 353
 connection of Eros, Ananke and Hermes
 340, 353
 Daimon and 340, 386
 Eros and 340, 353, 380, 386
 in Macrobius 340–41, 353–54, 356, 380,
 387–88
 knot of Hercules and 340, 353n74, 354,
 380, 385
 Lots of Fortune, Daimon, Eros, Necessity
 and 341, 353, 356, 387
 luminaries (sun and moon) and 340–41,
 386
 Mercury/Hermes and 340, 381n156
 Orphic connections 353–54, 385
 peace and 381
 snakes and 81–82, 340, 354, 381n156,
 385–86
 Tyche (Fortune) and 340, 386
- Cain. *See also* angels, Gnostic, Kain 174, 176
- Calcidius 28–29
- Cassius Dio 169–70
- Catullus
Poem 64 389
- Ceres 295
- Chaeremon 112, 224, 274
- Chaldean Oracles 125–26, 163, 165, 233, 350,
 379
- Chaos 176, 342, 351
- character 1–2, 8, 114, 226–29, 240, 243, 246,
 297, 433
 decans and 226–29, 235
 lots and 287, 297, 306, 321, 367, 447, 454,
 458
- ‘Character is destiny’. *See also* Heraclitus;
 daimon, character and 1
- Charis 233, 345
- Chronos (Orphic deity) 352, 355, 386
- Chronos/Herakles 351, 353–54
- Chrysippus 336
- Cicero
Aratea 355
De divinatione 280, 294
De natura deorum 381
- Circle of Athla. *See* Marcus Manilius, Circle of
 Athla
- clár (Celtic board, piece of wood) 280
- Claudia Capitolina 184
- Cleanthes 291, 354
- Clement of Alexandria
Stromateis 344n23
- Clotho. *See also* Moirai 25, 27, 30, 134, 283,
 396
- Clymene 342
- Coffin of Heter 92
- Commentary on the Tetrabiblos* 267
- Constantine VII Porphyrogenitus 288
 birthchart of 372–75, 479–80
- ‘Coptic Book’ 165–67, 170
- Cornutus
Theol. Graec. 52
- Cosmas of Jerusalem 232–34, 296, 300
- cosmology
 astrological 159, 164, 179, 393–94
 Babylonian 306
 Egyptian 105, 178, 206, 306, 351
 Empedocles’ 344
 Gnostic 160, 162–64, 173
 in *Asclepius* 221
 Mani’s 163
 Mithraic 182–83

- Court de Gébelin, Antoine 386
 Critodemus 37, 154
 Cybele 233
- daimon
 air and 26, 232–33
 aither and 26, 204, 220
 as ambivalent. *See also* Ch. 6, 194–235 5,
 12, 29, 218
 as interpreter. *See also* ἐρμηνεύω,
 ἐρμηνευτικός 20, 33, 45
 as minister 20, 61, 110, 180, 213, 218–19,
 221, 236, 285, 391
 character and 1–2, 8, 243, 246, 297, 306,
 321, 367, 447, 454, 458
 connection to *heimarmenē* 211–13
 cultural pair with tyche 6, 11, 46–50, 59,
 69, 77, 104, 115, 130, 264, 286, 300,
 303–04, 338, 389–90
 death and 5, 49, 126–27, 144, 150, 311, 332,
 449
 demonisation of 10, 132, 138
energeia and 29, 209, 212–13, 221, 228,
 233, 300
 etymology of 24
 illness and 5, 140, 194, 314, 335
 in Hermetic texts 123, 210–11
 intermediary between gods and humans
 5, 17, 20–21, 122, 126, 212, 220, 300, 302,
 337, 383
 madness and 5, 124
 moon and 21, 26
 multivalent concept of 4–6
 oracles and 20, 45, 294
 passions and 24–25, 123–24, 142, 212,
 239–41, 244, 246
 personal 3, 5–6, 9, 11–12, 17, 19, 23, 33–34,
 84, 122, 139, 163, 184, 195–99, 202, 210,
 236–39, 242–46, 247–51, 284–85, 389,
 391–94
 astrology and 9, 255, 257, 263–64,
 268–75
 soul and 124
 spelling of 4
 stars and 9–10, 24–25, 162, 193, 202,
 209–10, 213, 236, 242, 243
- daimonion*. *See also* Socrates' daimon/
daimonion; δαίμόνιον 33–34, 36–37,
 39–42, 206
- as evil daimon 137–40
 sign and 21–22
- daimonology, demonology 2, 17–21, 116, 125,
 133, 136–37, 162, 164, 209, 390
- Damascius
De principiis 351–54
On Parmenides 133
- decans
 as 'bright horoscopes' 211, 232, 234–35
 as horoscopes 210–11, 224–25, 234–35
 as *leitourgoi* 20, 219, 221, 249, 251
 as ministers 180
 astrological
 in Anubio and Firmicus 227–29
 in Cosmas of Jerusalem 232–34
 faces 173, 223, 228, 231
 in Hephaestio 224, 229–31
 illness and 219, 228
 in astrological medicine 219
 Indian 226, 231
 injury and 219
 in *Liber Hermetis* 231–32
 in Manilius 225–26
 in Paulus 229
 systems of 223
 in Teucer and Antiochus 226–27
- character and 226–29, 235
 daimons and 20, 173, 181, 213–15, 219–23,
 225, 235, 251
- Egyptian 173, 213–20, 235
 arrows. *See also* šr.w 215, 219
 as ministers 218–19
 definition of 10, 214
 emissaries. *See also* hby.w 215
 fighters. *See also* hʒty.w 215, 217
 illness and 214–16, 222
 influence on weather 162
 injury and 216
 messengers. *See also* wpwtj.w 215
 servants 217, 219, 251
 Seti I B series 234–35
 Seti I C series 235
 Tanis series 218, 235
 wanderers. *See also* šmʒy.w 215, 217
- 'hour regulators' 227
 illness and 222, 228, 235
 in Hermetic texts 220–22
 in *Pistis Sophia* 180, 251
 number 36 and 220–21, 233

- Delos 49, 82
 Delphi 18, 125, 280
 Demeter 78, 81, 88, 354
 demon. *See also* bad daimon, evil daimon;
 spirit, bad, evil 4–5
 Christian 132, 134n101, 136–38, 222
 Egyptian 119
 emissaries. *See also* *hby.w* 121
 fighters. *See also* *ḥṣty.w* 121
 messengers. *See also* *wḫwty.w* 121
 wanderers. *See also* *šmṣy.w* 121
 Greek 122
 illness and 117, 119, 128, 130, 137–38, 140,
 222
 in Gnosticism 163
 Jewish 127–36
 Deber 127–29
 Lilith 119, 127–28
 Qeteb 127–30
 Resheph 128
šēdīm 128
 madness and 138
 Mesopotamian 116–18
ardat lilī 117, 119
gallū 118
 Lamaštu 117–18
lilū, lilītu 117, 119
 Pazuzu 117–18
rābiṣu 118
utukku 116, 118
 offspring of evil angels 131–32
 passions and 162
 possession by 125, 131, 137–38, 140
 pre-Islamic 127
 Demotic astrology. *See* astrology, Demotic
 Dendera 215
 Dendera zodiac 221
 determinism. *See also* fate 10, 38–39, 112,
 113–14, 238, 298, 336, 389
di manes 294
 Dike 24, 233, 343, 349, 352, 381
 Diodorus Siculus 86, 110, 161
 Diogenes Laertius
Lives of the Philosophers 78
 Dionysus 78, 351
 Diotima 344, 346
 divination 45, 131–32, 247, 284, 289, 293,
 296–97, 302, 337–38
 allotment, lots and 290–94, 297–98, 301,
 308, 458
 astral 39n84, 112n79, 214–15
 astrological chart as means for 301–02
 astrology as 12, 112–13, 183, 294, 301–02, 317
 by augury 56–57
 by lightning 294
 by statue 253–54
 by water 134, 136
 Babylonian extispicy 296
 Etruscan liver 57n51, 294, 296, 317
 connections to the heavens 294
 connection to Martianus Capella's
 16-region pantheon 294–96
 katarctic astrology and 294, 317, 388n180
 'technical' 247–48
 theurgical 247–49
 vessel 206–08
 dodekaoros 172–73, 205–06, 226
 definition of 454
dodekatēmoría 301n73, 425, 438
 Dodona 280
 Dog-Star. *See* Sirius
 Dolos (Treachery) 233
 Dorotheus of Sidon
 on astrological places 62–64, 126, 143,
 145, 227
 on lots 279, 287–88, 310–11, 359–60
 on the *oikodēspotēs*. *See also* *haylāj*;
kadhkhudāh 258–59, 265, 272
doryphoria 200, 215
 dualism 128, 138, 160–63
 Duat (Egyptian afterworld) 55, 120
 Dura-Europos 94–95, 130
 eclipse 20n10, 118n11, 127n60, 259
 ecliptic 57, 179, 306, 355, 386, 400, 402
 'Eighth Book of Moses'. *See also* PGM XIII
 (Citations Index) 200–04
 element. *See also* στοιχείον 133, 226, 344
 Eliot, George (a.k.a. Mary Ann Evans) 1
 Eloai. *See* archons, Eloaios
 Eloaiou. *See* archons, Eloaios
 Eloeus. *See* archons, Eloaios
 Elpis (Hope) 233
 Empedocles 123, 342, 379
 love and strife (*philia* and *neikos*)
 344–45, 349

- Enlil 280
 Enuma Eliš 116
 equinox 69, 93, 182–83, 399
 Erikepaios 351
 Erinys. *See also* Furies 122, 233
 Eris 134, 378
 Eros (deity/daimon). *See also* ἔρως 300, 378, 383
 Aphrodite and 342, 344, 359, 381, 447, 456–57
 Charis and 345
 child of Poros and Penia 346–47
 Eros Ouranios 346, 348, 384
 Eros Pandemos 346, 384
 ‘great daimon’ in *Symposium* 239n19, 346
 in the Chaldean Oracles 350
 in Cosmas of Jerusalem 233–34
 in the *Hermetica* 349
 in Hesiod 342, 346
 in Macrobius 36n73, 340–41, 380, 386
 in Parmenides 343–44, 346
 in Plutarch 348, 384
 Orphic 351–53, 472–73
 pair with Necessity/Ananke 339, 346, 349–50, 379–81, 383, 386, 388
 philia and 344–45, 349
 Sun and 348
 Esna 216
 ethos 1, 383
 Eusebius
 Praeparatio Evangelica 247, 253
 exaltation, astrological 185, 193, 234, 256, 259–60, 264, 407–10
 exorcism 131, 137–38, 195

 faces (*prosōpa*) 172–73
 faces, astrological 173, 223, 226, 228–29
 fatalism. *See also* fate 10, 38, 114, 238, 336, 389, 391–92
 fate. *See also heimarmenē*, determinism, fatalism, εἴμαρμένῃ
 as a law. *See also* νόμος 29, 37, 90, 103, 106, 226
 astrologers’ views of 3, 37–39, 113–14, 238, 245–46
 astrology and 9–12, 19, 28, 33, 37–38, 40–45, 77, 90, 95, 100, 106–8, 112–15, 140, 207–08, 238, 242, 245–46, 336, 389, 391–92, 395
 astrology, daimon and 9–10, 19, 28, 40–45, 90, 140, 242, 389, 392, 394
 changing of 105–06, 110, 114, 203, 200–04, 391–92
 Egyptian concept of 3, 10, 12, 76, 85–86, 90–91, 95–99, 112–15, 204, 274, 286, 391
 euphemism for death 105–07, 109
 Greek concept of 10, 12, 28–33, 46, 76, 90–91, 95, 112–15, 391
 Isis and 90–91, 106, 114, 203, 420–21
 Mesopotamian concept of 3, 10, 12, 95, 108–15, 286, 391
 Stoic 336
 Ficino, Marsilio 10, 263n110
 De vita 3, 236
 Firdar 376
 Firmicus Maternus, Julius
 ‘Homer’s’ chart 70–71
 on astrological places 69–74, 142, 144
 on decans 227–29
 on lots 288, 309, 311–13, 361–66
 on planets 70–73, 147
 fortune (*tuchē*). *See also* Tyche 8, 19, 27, 44, 53, 56, 60–64, 70, 74, 88, 90–91, 95, 101–02, 199, 218, 243, 261, 290, 305–06, 310–11, 327–28, 367, 382–83, 391, 449, 452, 457, 469, 479
 cultural pair with daimon 6, 11, 46–50, 59, 69, 77, 104, 115, 129–30, 264, 286, 300, 303–04, 338, 389–90
 Fortune, Fortuna. *See* Tyche
 Freud, Sigmund 303, 335, 339, 381
 Furies. *See also* Erinys 345–46

 Gad (deity) 94, 129–30, 390
 Gaia 342, 351
 Galen, Claudius 42, 124, 225, 314
 De consuetudinibus (On Habits) 34
 De usu partium (On the Usefulness of the Parts) 33
 personal daimon and 33–34
 Gates of Cancer and Capricorn. *See also* Porphyry, *On the Cave of the Nymphs in the Odyssey* 170, 182
 Geb 351n57

- genie 4, 50, 98, 101, 217, 223, 254
 genius. *See also* *genius* 4, 22, 83, 94–95, 111, 141
 (evil), mischaracterisation of
 6th astrological place 141
 11th astrological place. *See also* places,
 astrological, 11th (Good Daimon) 70
 Genius of Dura 94–95
 geomancy 285
 Getae 161
 gnosis 163
 Gnostic texts
 Apocryphon of John 164, 166–68, 171–73, 174–77
 Gospel of Judas 164, 175–79
 Holy Book of the Great Invisible Spirit
 174–77
 On the Origin of the World 132, 134, 164–66, 169–70
 Pistis Sophia 163–64, 172, 174, 179–81, 251
 Gnosticism 12
 cosmology of 160, 162–64, 173
 daimons and 159
 faces and 172–73
 zodiac and 164
 good daimon. *See also* Agathos Daimon
 (deity) 5–6, 9, 11–12, 20, 47, 110, 116, 124, 126, 159–163, 165, 184, 194–95, 209, 237, 243, 284, 317
 good fortune. *See also* fortune (*tuchē*) 61, 67, 88, 101–02, 111, 204–05, 208, 281, 324, 327, 453, 464
 Gorgis, wife of Posidonius of Halicarnassus 47, 48
Gospel of the Egyptians. *See* Gnostic texts, *Holy Book of the Great Invisible Spirit*
 Graces 352
 Great Bear (Ursa Major) 99, 249, 251–52

 Hades 125–26, 230, 233, 280
 Hadrian 80, 191, 258, 429–30
 Haoth. *See* angels, Gnostic, Athoth
 happiness (*eudaimonia*). *See also* εὐδαιμονία 9, 20, 34, 59–60, 76, 124, 228–29, 286, 311, 317, 347, 453, 463–65
 felicitas 463–65
 ‘Harper’s Song of Intef’ 105
 Hathor. *See also* Seven Hathors 78, 100n109, 217

haylāj. *See also* hyleg, *aphetēs* (releaser), *apheta* 258–61, 265
hayyiz (*hayz*) 66
 hebdomad 165, 169, 171–72
 Hecate 126, 233
 Hector 280
heimarmenē. *See also* fate; εἰμαρμένη 45, 243–45, 266, 274–75
 astrology and 37–43, 202–03, 211–13, 238
 daimon and 211–13
 definitions of 29–30, 103, 112, 221
 in *De fato* 29–33, 221, 391
 in Gnosticism 179, 181
 Isis and 91
 law and 91, 103–04
 necessity and 112, 238, 349, 381–82
 three levels of 29–30
 Hekate. *See* Hecate
 Hephaestio of Thebes 239
 on astrological places 66, 144, 150
 on consecrating statues 253–54
 on decans 224, 229–31
 on *katarchē* 66–67, 248n53, 360, 366–67 (scholion), 388n180, 392
 on length of life 66, 287, 331
 on Lot of Eros 359–60
 on Lot of Fortune 287
 on lots of Fortune, Daimon, Eros and Necessity 360, 366–67 (scholion)
 on the *oikodespotēs* 253, 256n86, 258, 264, 266
 on the personal daimon 264
 on planets 150, 154
 on the *Salmeschiniaka* 224, 230–31
 Hephaestus 207, 233
 Hera 88
 Heracles 233
 labours of 291
 Heraclitus 1, 110
 Herakles. *See* Heracles
 Hermas. *See* angels, Gnostic, Harnas
 Hermes/Mercury 56, 60, 63–64, 67, 70, 72–74, 123, 133–34, 140, 143, 147–48, 154n185, 168–70, 172n63, 174, 176, 178, 180, 187, 212, 219, 224n134, 234, 241n27, 251n63, 256n86, 295–99, 315, 319–20, 322, 325–27, 329, 340, 353–54, 356–57, 359, 361, 365n113, 366–67, 369–70n128, 374n132, 376–78, 381–83, 385–87, 387,

- Hermes/Mercury (cont.)
 399, 403–04, 408–09, 419, 423–27,
 429–32, 434, 437, 447, 456–58, 470–71,
 476, 479–82
- Hermes Trismegistus 64, 296, 299, 366–67,
 457–58
- Hermetica* 9, 194, 255, 356, 379
- Asclepius* 83, 210, 213, 221–22, 225, 286, 349
- CH X* 162, 192–193
- CH XVI* 123, 209, 220
- daimons and stars in 9–10
- Korē Kosmou* 349–50
- SH VI* 220–221, 252
- SH VIII* 381
- SH XIII* 349
- Hermouthis. *See* Renenet (Egyptian divinity)
- Herodotus
Histories 101, 380
- Herrick, Robert 46
- Hesiod 20, 61, 346, 379
 daimons in 5, 98
Theogony 342
Works and Days 98
- Hestia 88, 161, 233
- Hierocles 237
- Himeros 342
- Homer 4–5, 20, 61, 229
 fictional chart of 70–71
Iliad 22, 280n8, 342, 413
Odyssey 22
- Homeric Hymn to Aphrodite 342
- Horai (Hours) 233, 352, 413
- Horaios. *See* archons, Oraios
- Horeus. *See* archons, Oraios
- Hour-marker. *See* Ascendant (rising degree);
 places, astrological, 1st place; ὠροσκόπος
- hours, planetary 134–36, 148, 169, 172, 201, 404
- house (dignity), astrological 185, 193, 256,
 259–60, 264, 407–10
- house-master. *See* *oikodespotēs*
- Housesteads Monument 191–92
- Hugo of Santalla
Liber Aristotilis 259
- Hygeia 233
- Hyginus
De astronomia 355
- Hygromanteia of Solomon* 132, 134, 136, 422
- hyleg. *See also* *haylāj* 259
 Lot of Hyleg 262n106
- ‘Hymn to Amun’, 105
- Iamblichus 9, 12, 254, 267n122
Commentary on the Timaeus 269n130
De mysteriis 124n43, 133n100, 224,
 236–38, 241–42, 246n48, 248–50,
 252–53, 269n130, 272–73
- dialogue with Porphyry in *DM* 247–52
- on astrology 237–38, 247, 251, 253, 392,
 394
- on astrology and the personal daimon
 248–50
- on astrology as theurgy 247–48
- on hierarchy of divine beings 238
- on the *oikodespotēs* 12, 250, 252–53,
 260n98, 268, 272
- on the personal daimon 9, 236–37,
 241–42, 248–51, 255, 273, 391–92
- on statue divination 253
- on theurgy 247, 249, 273, 394
- relationship with Porphyry 238
- Iaoth. *See* archons, Athoth
- Iapetus 342
- iatromathematics. *See* medicine, astrological
- Ibn Ezra, Abraham 387
The Beginning of Wisdom 365
The Book of Reasons 365
- idols
- Jewish
’elilim 129
- Imhotep. *See also* Asclepius (deity) 207
- Imouthes. *See* Imhotep
- incubation 24, 78
- ‘Instruction of Papyrus Insinger’ 91, 102, 114
- Iobēl. *See* angels, Gnostic, Yobel
- Ios 87
- Irenaeus
Against Heresies 165–67, 169–70
- Isaews 52
- Ishtar 111
- Isidorus
 Hymns to Isis 84, 86–88
- Isis 233
 Agathe Tyche and 47, 77–82, 88, 91,
 94–95, 390
- aretalogies to 77–78, 86–91
 hymns of Isidorus 84, 86–88
 Kyme 87, 89–90, 420–21
 as Selene 78

- decans and 217
 fate and 53, 86, 90–91, 106, 114, 203,
 420–21
 fortune and 53, 88, 91, 102, 106
pronoia (providence) and 91
 Renenet and 80, 87, 90, 100–101, 106, 390
 Sarapis and 47, 78–81, 94–95, 390
 Shepset and 88–89, 101
 Sirius (Sothis) and 89, 217
 snake form of 79
 Thermouthis and 79–82, 87–88, 100–101
 wealth and 88
- Janus 295
 Jesus 131, 137–38, 180
 Jeu 179
 joys of the planets 67, 406–07
 Jupiter 52, 74, 407, 418
 Mars 142, 407
 Saturn 142, 146, 407
 Venus 35, 74, 111, 407, 417
- Julia Balbilla 184
 Julian of Laodicea 257
 on consecration of statues 254
 on *katarchē* 67
 Julian the Emperor
 Oration to the Sun 212
 Julius Caesar 188
 Jung, Carl 10, 279, 338
 Juno 295
 Justin Martyr 132
- ka* (soul) 205, 218
kadhkhudāh. *See also* alcocoden 259, 261,
 265
 Kae. *See* angels, Gnostic, Kain
 Kainan. *See* angels, Gnostic, Kain
kairos. *See also* *katarchē*, *katarchic astrology*;
καίρός, καιρικός; καλή ώρα; καταρχή
 40–41, 139n132, 247–48, 412
 and *chronos* 43–44
 Kairos (deity) 233
kakodaimonia 112, 124
kalathos (grain measure) 78, 94
 Kalila-Oumbri. *See* angels, Gnostic, Galila
 Kasin. *See* angels, Gnostic, Kain
katarchē, *katarchic astrology*. *See also* *kairos*;
καταρχή; καιρός, καιρικός; καλή ώρα
 411–12
- events, elections 62, 293, 411–12
 extant *katarchic charts* 258n91, 375n135,
 436–38
 for negotiating fate 113–14, 392
 in Hephaestio 66–67, 360, 366–67
 (scholion), 388n180, 392
 in the *Magical Papyri* 195–200, 203,
 205n46, 207–08
 in Manilius 293–94, 317, 392
 in ritual 247–48, 360, 366–67, 392
 interrogations 62, 293, 412
 in theurgy 247–49, 392, 394
 in Valens 40–42
 in Zosimus 139, 392
kairos and 40–41, 139n132, 247–48, 412
- Kematef. *See* Knephis
kēr 122
 Khepri 198–99
 Khirbet et-Tannur 78, 92–95, 178
 Knephis 84
 knot of heaven 355
 knot of Hercules 340, 353–54, 380, 385–86
 and Necessity 340
- Kore 233
 Kronos/Saturn 36n73, 57–58, 63–64, 67, 70,
 74–75, 78, 127, 134, 136n113, 142, 146–48,
 150–51, 153–54, 172–76, 182–83, 187, 234,
 241n27, 244, 256n86, 297–99, 315, 319,
 322, 325–27, 329, 349, 352n61, 357, 367,
 370n129, 377n146, 385–87, 399, 403–04,
 407–09, 419, 423, 426, 429, 431–32,
 434–38, 447, 453, 456–57, 470, 479–82
 as black sun 175
 Ialdabaoth and 165, 167, 170
 in Mithraism 189–90
 Phainon (old name of) 165, 167
- kubernētēs* metaphor 269–70
 Kyme aretology to Isis 87, 89–90, 420–21
- Lachesis. *See also* Moirai 25, 27, 30, 282, 283,
 284, 344, 347, 396
- lares* 294
 length of life 9, 65–66, 107–8, 112, 260,
 330–35
 Lesser Bear (Ursa Minor) 249, 251–52
 Leto 87, 233
 Leucippus 381
 Leuctra 280
 Leviathan (Ophite serpent) 162

- Liber Hermetis* 126
 on astrological places 144
 on decans 231–32
 on lots 279, 359–60
- Litai 233
- Loimos (Plague) 233
- lord of the nativity (lord of the geniture).
See also oikodespotēs (house-master);
dominus geniturae 246, 255, 257, 259n96,
 262–64, 268–72, 394, 435, 439–45
- Lot of Daimon. *See also κλήρος τοῦ δαίμονος*
 13
 attributes of 306
 formula 7, 297, 411, 446
 sect and 307–08, 329–35, 409
 functions of 7–9, 49, 263, 266, 308–14,
 321, 335–38, 356–57, 367, 447–49,
 450–54, 455–59
 grouped with Lot of Fortune, Lot of Eros
 and Lot of Necessity 9, 318, 323, 342,
 357n91, 360, 366, 378, 384, 386–88, 392
 illness and 148, 314, 335, 468–69
 in Proclus 286
 in profections 307, 323–27, 335, 388
 in time-lord systems 307, 321–23, 335
 length of life and 107–08, 287, 330–35
 melothesia 313–14, 468–69
 mind and 27, 297, 305–06, 356, 455–59
 moon and 288
pars absentiae 313
pars celati 313
 places from the 319–21
 soul and 8n28, 27, 45, 297, 305–06, 309,
 390, 447, 455–59
 sun and 8, 27, 45, 286, 299, 305–06, 348,
 390, 447, 455–59
- Lot of Eros. *See also κλήρος τοῦ ἔρωτος* 13,
 234
 attributes of 298, 384
 Daimon and 298
 double tradition of 360–67
 Firmicus version of 356, 361–64
 formula 363–64, 367–68, 374
 functions of 9, 299, 356, 359–60, 367–74,
 447–48, 458–59
 grouped with Lot of Fortune, Lot of
 Daimon and Lot of Necessity 9, 318,
 323, 342, 357n91, 360, 366, 378, 384,
 386–88, 392
 in extant charts 367–77, 477–80
 pair with Lot of Necessity 303n2,
 378–80, 383, 388
 Paulus/Hermetic version of 356, 387
 Venus and 298–99, 356, 359, 384, 387
 formula 297, 361, 375–76, 387, 383
 in profections 326, 357–58, 388
 Valens version of 356, 361
 formula 364–66, 446
- Lot of Fortune. *See also κλήρος τῆς τύχης* 12,
 64, 88, 281
 ‘lunar horoscope’, 330
 attributes of 306
 body and 27, 45, 297, 305–06, 309,
 313–14, 321, 390, 447, 455–59, 468–69
 formula 7, 297, 411, 446
 sect and 307–08, 329–35, 409
 functions of 7–9, 49, 263, 266, 308–14,
 335–38, 356–57, 367, 447–49, 450–54,
 455–59
 grouped with Lot of Daimon, Lot of Eros
 and Lot of Necessity 9, 318, 323, 342,
 357n91, 360, 366, 378, 384, 386–88, 392
 illness and 148, 314
 in Proclus 286
 in profections 307, 323–27, 388
 in time-lord systems 307, 321–23
 injury and 311, 314, 468–69
 length of life and 107–08, 260, 287,
 330–35
 melothesia 313–14, 468–69
 moon and 8, 27, 45, 286–88, 299,
 305–06, 312, 390, 447, 455–59
 place of acquisition and 52, 65, 68, 293,
 318–19, 329, 390
 places from the 321
 in Manilius 289–96
 in Valens 317–19
- Lot of Necessity. *See also κλήρος τῆς ἀνάγκης*
 13, 36n73, 234
 attributes of 298
 double tradition of 360–67
 Firmicus version of 356, 361–64
 formula 363–64, 367–68, 374, 475
 Fortune and 298, 383
 functions of 9, 299, 356, 359–60, 367–72,
 447–48, 458–59
 grouped with Lot of Fortune, Lot of
 Daimon and Lot of Eros 9, 318, 323,
 342, 357n91, 360, 366, 378, 384, 386–88,
 392

- Hermes/Mercury and 234
 in extant charts 367–72, 376–78, 477–82
 in profectioes 323, 358, 388
 pair with Lot of Eros 303n2, 378–80, 383, 388
 Paulus/Hermetic version of 356, 387
 formula 297, 361–62, 375–78, 383, 387, 476
 Mercury and 298–99, 356, 359, 378, 383, 387
 Valens version of 356, 361, 387, 446, 475
 formula 364–66, 370, 372, 446
- lots
 astrological. *See also* Lot of Fortune;
 Lot of Daimon; Lot of Eros;
 Lot of Necessity; κλήρος 7, 12, 279, 409, 411
 abstract names of 300
 as mirror images 7, 303, 308, 338, 379, 388, 390, 392, 411
 as proportional 287, 301, 308, 330
 definition of 7, 287
 ‘Egyptian’ tradition of 366–68, 374–76, 378, 387, 477–79
 formulae of 475
 ‘Hermetic’ 234, 296–99, 304, 361–62
 formulae of 297, 374–78, 383, 387, 476
 tradition of 366–67
 in *Panaretus* 296, 366, 457
 Lot of Accusation 446
 Lot of Advancement and Victory.
See also lots, astrological, Lot of Victory 481–82
 Lot of Basis. *See also* κλήρος τῆς βάσεως 336
 case study of 327–29
 formula 288, 309–10, 446
 functions of 447, 451–452, 454
 Lot of Bravery. *See also* lots, astrological, Lot of Courage 377, 481–82
 Lot of Brothers/Siblings 279, 388, 446
 Lot of Children 75, 446
 Lot of Courage 234, 299, 377, 447, 455–59
 formula 297
 Lot of Debt 446
 Lot of the Destroyer (ἀναίρετης) 452, 454
 Lot of Exaltation 193, 319–20, 326, 329, 450
 formula 446, 452
 Lot of the Father 279, 388, 446, 451, 454, 458–59
 Lot of Friendship 373
 Lot of Injury 448
 Lot of Intellect and Native Wit. *See also*
 Lot of Necessity, Paulus/Hermetic version of 377–78, 387n179, 476, 480, 482
 Lot of Livelihood (*bios*) 372
 Lot of Living Abroad 480
 Lot of Marriage 279, 372, 388, 446, 480
 Lot of Military Service 373
 Lot of the Mother 279, 388, 446, 451, 454, 458–59
 Lot of Nemesis 234, 288, 299, 455–59
 formula 297
 Lot of Poverty and Lack of Means.
See also Lot of Necessity, Valens version of 387n179
 Lot of (Slight) Intellect. *See also* Lot of Necessity, Valens version of 387n179
 Lot of Theft 446
 Lot of Victory 234, 299, 377, 455–59
 formula 297
 planetary 234, 287, 296–99, 304, 307, 356, 367, 378, 387–88, 390
 sect and 296, 301, 307–08, 329–31, 334–35
 cultural. *See also* κλήρος 279–81
 as proportional 281, 287, 301
 etymology of κλήρος 280, 362
 in Babylonian mythology 280
 in divination 12, 280, 289, 293–94, 298, 302
 cultural (cont.)
 lot oracles 280, 302
 meanings of 280
 Myth of Er and 282–86
 use of 280–282, 300–301
 luminaries (Sun and Moon) 22, 133, 147, 153–54, 175, 196, 211, 215, 256, 265, 268, 271, 273, 304–05, 307, 311, 330–31, 399, 403, 408, 431, 434–35, 440–41, 443
 Lycians 87

- Macedonia 85
- Macrobius 36, 78, 241, 340–41, 353–54, 356, 380, 386–88, 404
Commentary on the Dream of Scipio 340, 353
Saturnalia 340–41, 353
- magic 2, 6, 132, 136, 138, 194, 204
- Magical Papyri (Greek and Demotic) 9, 48, 126, 136, 138, 193–195, 199–200, 205, 213, 246, 248
- makaan* (place) 64
- Manetho (astrologer)
 on astrological places 144, 150, 227n149
 on astrology 251
 on fate 347
 on length of life 331
 on planets 150
- Mani 163
- Manichaeism 160, 163
- Marcus Manilius
 Circle of Athla 289–96, 317
 comparison to Martianus Capella's 16-region pantheon 294–96, 300
 Egyptian connection and 57–58, 61
 katarthic astrology in 293–94, 317, 392
 on astrological places 56–61, 140, 143, 149–50
 on decans 225–26
 on lots 286, 289–96, 307, 317
templum and 56–57
- Maroneia 87
- Mars Quirinus 295
- matter. *See also* ἔλη 20, 125–26, 162–65
- Maximus of Tyre
Orations 49
- medicine 33, 385
 astrological 216, 219, 228
- Medînet Mâdi 84n35, 87, 100n109, 314–15
- Meidias Painter 381
- Melcheir-Adonin. *See* angels, Gnostic, Adonin
- melothesia 175, 412, 469
 decanal 216, 219, 220
 lot (Fortune and Daimon) 313–14, 468–69
 sign (zodiacal) 152–55, 219
- Memphis 79, 83–84
- Memphite Theology 104
- Menander 237
- Meni (deity) 129–30, 390
- menit* 219
- Mephis. *See* Knephis
- Meskhenet 95–98
- Metis 351
- Midheaven (as culminating degree) 58, 70, 205n48, 261, 266, 279, 287, 300, 360, 368, 400, 413, 423, 431–32, 434
- Middle Platonist, Middle Platonism 18n3, 28, 38, 61, 237, 392
- Mithraeum at Ostia 385
- Mithraism 12, 159, 161, 181–84, 188–93, 352, 385–86
 astrologers and 182–84
 astrology in 182–84, 188–93
 cosmology of 182–83
 planets as tutelary powers 182
- Mithras 182–83, 189–92
- Modena 353
- moira*. *See also* μοῖρα; μοιρικός, μοιρικῶς
 as degree 211, 412–14
 as fate/destiny 110, 112, 134, 187n125, 283, 391, 413–14
 etymology 412
- Moirai. *See also* Atropos; Clotho; Lachesis
 25, 27–28, 30, 36, 203–05, 233, 240, 284–85, 345–48, 352, 394, 413–14
- monomoiria* 180, 301, 371
- moon 26–27, 89, 92, 131, 134, 163, 177, 249, 340–41, 344, 352, 386, 390–91, 420, 422
 aither and 26
 and left eye of Horus 205
 body and 27, 45
 Clotho and 27
 daimon and 21, 26
 fortune and 27
 in Magical Papyri 201, 204–5
 Lachesis and 27
 reflects sun's light 26
 soul and 26
 transmits sun's light 21
- Moon (astrological) 36, 45, 55, 58, 60, 63, 67, 70, 72–75, 107–08, 126–27, 133, 153, 155, 165, 178, 182, 193, 223, 268–72, 286–88, 290, 297, 299, 305–08, 310–15, 319, 322–23, 325, 328–36, 338, 355, 357, 359, 369–70, 373–77, 387, 390–91, 399–400, 403–04, 406–11, 418, 423–26, 429, 431–32, 434–38, 440–44, 446–47, 453–54, 456–66, 469–71, 479, 481–82

- and left eye 205
 as minister 21
 body and 21
 decans and 234
 fortune and 50, 218
 in Mithraism 182–83
oikodespotēs and 256, 258–63, 265–66
 planetary orders and 168–77
 pronoia and 37
 reflects sun's light 25–26
 significations of 21–22, 25–27, 148–51, 245
 soul and 218, 240
Thema mundi and 186–89
- Moses 161
- Nakovana Zodiac 235
- namburbi* rituals 110, 131
- Naos of the Decades 120–21, 162n14, 217, 230
- Narmouthis. *See* Medînet Mâdi
- Necessity (deity/daimon). *See* Ananke, Necessity (deity/daimon)
- necessity, *anankē*. *See also* Ananke, Necessity (deity/daimon); ἀνάγκη, ἀναγκαῖος; Ἀνάγκη
- chance, fortune and 382–83
 compulsion, force and 342, 344–346, 349, 380–81
 etymology 379
fate/heîmarmenē and 112, 342n13, 345, 346n30, 347, 381n158, 382n160
logos (reason) and 381–82, 457
 Saturn and 36n73, 349
 time and 349–52, 355, 386n175
- Nechepso 107, 108
 on length of life 332
- Nechepso and Petosiris
 on astrological places 143
 on length of life 333
 on the Lot of Daimon 333
 on the Lot of Fortune 333
 on lots 279, 287, 317n53
 on the *oikodespotēs* 257
 on the *Thema mundi* 185–86
- Nectanebo 85, 235
- Nemesis 233
- Nemesius 28–29
De natura hominis 31
- Neo-Platonism, Neo-Platonist 3, 9, 123, 125, 236, 340, 352–53, 392, 394
 daimons and 237–38, 246, 270
 dualism in 163
- Nephilim (giants) 131
- Nerva 86
- Night (Orphic deity) 351–52
- Nike 92, 233–34, 300, 352
- nous*. *See also* νοῦς 22, 24–27, 37, 45, 123, 162, 211, 218, 269, 337, 390–92
 Eros and 350
nous/daimon 25, 34, 41, 391
 'pilot of the soul' 269
- Novalis (German novelist) 1
- Numenius 170, 237
 Fragment 18 269
- Nut 351n57
- Nymphai 233
- Oceanus 233
- Odysseus 274
- oikeiosis* 142
- oikodespotēs* (house-master). *See also* οἰκοδεσπότης, οἰκοδεσποτέω 12, 255–66
 and length of life 258, 260, 265–66
aphetēs and 258–59
 co-housemaster 256, 264, 271–72, 424, 428, 440–45
 definitions of 255–57
haylāj and 258–61, 265
 in extant charts 258, 423–38
kadhkhudāh and 259, 261, 265
 lord of the nativity and 246, 255, 257, 259n96, 262–64, 268–72, 394, 435, 439–45
 Porphyry and 237, 248–49, 251n61, 255–57, 439–45
 predomination and 253, 257–58, 260–61, 265–66, 270–73, 439–45
- Olympians 351
- Olympiodorus the younger 237, 239
 on aspects 154
 on astrological places 74, 144
 on *katarchē* 200n26
 on lots 286–87, 296–99, 307–09, 359–61, 366
 on the *oikodespotēs* 258, 264, 266, 272
 on planetary hours and days of the week 135

- Ophite Diagram 162, 164, 167
 Ophites 162, 192
 oracle 20, 47, 113, 280, 282, 284, 302, 345, 351, 381, 388
 orders, planetary 159, 167–72, 182
 Chaldean 167–69, 171–73, 201, 403–04
 Platonic (Egyptian) 168, 403–04
 weekday 168–69, 171–73, 404
 zodiacal 168, 171
 Oureus. *See* archons, Oraios
 Origen 165–67, 170–71, 173
 Contra Celsum 162, 166, 170–71, 183, 219–20
 Orpheus 355
 Orphic fragments 355
 Orphic Hymns 52, 350, 352, 472–74
 Orphism 340, 351–52
 Osiris 19, 78, 84n35, 120, 217, 233
 Osor-Hapi 79
 Osorkon II 215–16
 Ouranos 351–52
 ouroboros 162
 Oxyrhynchus 89, 234, 370, 372
- Palmyra 94, 130
Panaretus 296, 366, 457
 Papyrus of Ani 96–97
 Papyrus of Taminiu 120
paranattelonta 173, 226, 229
 Parmenides 342, 346, 349, 379, 381
 Paulus Alexandrinus 239
 on astrological places 74, 107, 144
 on decans 229
 on length of life 107
 on lots 286–87, 296–99, 307, 359–62, 366
 on the *oikodespotēs* 107, 258, 263, 266, 272
 on planetary hours and the days of the week 135, 169, 207n53
- Pausanias
 Description of Greece 50, 346, 381
 Peitho 380–81
 Penia (Poverty) 347
 Petosiris
 on the Lots of Fortune and Daimon 333–34
 on the *oikodespotēs* 260–61
 Persephone 26, 233
- Phainon. *See* Saturn, Kronos
 Phanes 351–53, 385
 Philo of Alexandria
 Legatio ad Gaium 188
 Phobos 233
phronēsis. *See also* φρόνησις 22–23, 337, 392
 Piacenza liver 294, 296
Picatrix 136
pinax (astrological board) 205, 208–09
 places, astrological 56, 400–01
 angles (centrepins) 55, 60, 65, 67, 140, 149, 185nn116 and 118, 190, 234n173, 259, 261–63, 312n34, 317–18, 321, 324n66, 331n82, 357n91, 367, 400–01, 454, 464
 as operative places 58, 69, 263, 312, 318, 331n82, 357n91, 401, 416, 441, 443–44, 463
 cadent (declines) 67, 140, 141, 155, 312, 324n67, 392, 401, 463
 ‘metakosmios’ 145, 151
 succedent (post-ascensions) 67, 263, 392, 401, 417, 463
 derived places 52
 from lots 317–21, 452
 place of acquisition 52, 65, 68, 293, 318–19, 329, 390
 1st (Ascendant). *See also* Ascendant (rising degree); ὠροσκόπος 39, 55, 57, 62, 66–70, 73, 76, 100, 107–08, 142, 145, 149–51, 154–55, 178, 186, 188–89, 192, 201n32, 227, 259–61, 263, 271, 273, 285, 289, 294, 296, 304, 310n29, 318, 320, 326–29, 356–57, 360, 377, 400–01, 404–05, 407, 417, 419, 424, 426, 431–32, 440–41, 443, 452, 464–66
 as angle 55, 262, 368, 373, 401, 464
 as rudder (*oīax*) 64, 346
 2nd (Livelihood) 58, 74, 186, 271, 324n67, 400–01, 440
 Demotic 2nd, 304n7
 succedent 150, 263
 3rd (Moon Goddess) 21, 39, 69, 73n129, 145, 154, 223n34, 289n36, 400
 functions of 68–70
 ‘good decline’ 140, 401
 4th (Underground) 34, 50, 61n71, 62, 66, 190, 310, 317n52, 360, 400
 as angle 410, 417, 453
 Daemonium 57

- functions of 230, 289n36, 401
 Saturn and 58n54
 5th (Good Fortune) 6–7, 51, 53–56, 58, 69, 198
 Agathe Tyche and 46, 48, 50, 62, 70, 88, 4
 called *daimonie* 60–61, 390
 children and 60, 62, 65–66, 69–70, 74, 102, 417
 fortune and 67, 102
 functions of 60, 62, 65–68, 70–76, 102, 417
 illness and 60
 length of life and 107–08, 112, 261
 marriage and 67, 356
 pair with 11th 11, 46, 48, 50, 72, 76, 196, 390, 404
 succedent place/post-ascension 67, 263, 392, 417
 Venus and 50, 70, 72, 74, 112, 407, 417
 6th (Bad Fortune) 6–7, 11–12, 140, 400, 454
 ‘metakosmios’ 145
 averse and unconnected 73, 142, 405
 bad fortune and 140–42
 badness of 112, 142–45, 147, 155
 cadent/decline 140–41, 145, 155, 392, 401
 death and 126, 142–45
 Demotic 6th 141
 functions of 140–46, 453
 illness/injury and 127, 141–45, 148–49, 219, 356
 Mars and 142, 146, 407
 pair with 12th 140, 150, 155, 390
 7th (Setting) 63, 129n73, 154, 230, 317n52, 360, 400–01, 407
 as angle 263, 401
 functions of 66, 260, 401
 8th (Death) 58, 64, 73, 324n67, 401
 Demotic 8th 304n7
 functions of 75, 452
 ‘idle place’ 73
 succedent 263
 9th (Sun God) 21, 60, 66, 73n129, 145, 154–55, 260
 Demotic 9th 58n54
 functions of 35, 62, 65, 69–70, 356, 453
 ‘good decline’ 140, 401
 10th (Midheaven). *See also* Midheaven
 (as culminating degree) 58, 62, 64–66, 76, 154, 260–63, 271, 273, 289n36, 313, 319, 325–26, 329, 356–57, 360, 401, 423, 425, 430, 444
 action and 325, 356, 469
 as angle 55, 262, 317n52, 401, 425, 464
 as Fortune 57, 63–64
 Demotic 10th as goddess 57–58
 power of 62, 74, 329
 Venus and 57–58, 62
 11th (Good Daimon) 6–7, 51, 69, 148, 185, 198, 273, 319–20, 329
 ‘felix fortuna’ 58–59, 390
 Agathos Daimon and 46, 48, 50, 58–59, 62, 70, 293
 children and 62, 66–68, 356
 decans of 231
 Demotic 11th 53–56, 103, 218, 315–16
 fortune and 62–64, 67, 231, 311
 functions of 52, 58–60, 62–68, 70–76, 417–19
 Jupiter and 50, 52, 60, 70, 72, 74, 293, 407
 length of life and 65–66, 107–8, 112, 260–61
 pair with 5th 11, 46, 48, 50, 72, 76, 196, 390, 404
 succedent place/post-ascension 67, 263, 392
 12th (Bad Daimon) 6–7, 11–12, 48, 75, 154, 449, 454
 ‘metakosmios’ 145, 151, 293
 averse and unconnected 73, 142, 405
 bad daimon and 12, 116, 121, 127, 140, 155, 294
 badness of 112, 121, 142–45, 147–50, 155, 293
 cadent/decline 140–41, 145, 155, 392, 401
 childbirth and 142, 145, 150–51, 155
 death and 126–27, 142–45, 148
 Demotic 12th 54
 functions of 75, 140–46
 illness/injury and 127, 140, 142–45, 148–49, 219, 356
 pair with 6th 140, 150, 155, 390
 Saturn and 142, 146–47, 407

- planetary hours. *See* hours, planetary
 planetary orders. *See* orders, planetary
 planets
 as archons 162–65, 167
 as demons 162–65
 Chaldean order of 169, 171–73, 403–04
 Platonic (Egyptian) order of 168, 403–04
 weekday order of 168–69, 173, 404
- Plato 5, 17, 350
Apology 19n7, 21n18
 daimon in 2, 19, 98, 122, 124, 242, 284,
 304, 392
 Great Year 30
Laws 44n99, 49, 59, 281, 287
 Myth of Er 12, 24, 98, 181, 210, 236, 239,
 241, 244, 255, 306, 344, 346–47, 352, 355,
 379, 383, 391
Phaedo 242
Phaedrus 22n18, 242, 269
Republic 19n7, 24nn29, 30, 26n35, 98n97,
 240, 242–43, 282–83, 286, 306, 346–47,
 380, 404, 413n33
Statesman 269n130
Symposium 20n13, 239n19, 346, 348, 384
Theaetetus 242
Theages 19n7, 22n18, 24n27, 33
Timaeus 19n7, 21n14, 23, 25n32, 30n53,
 34, 133, 240n21, 242–43, 269, 285n22,
 381n58, 383n166, 404
- (Pseudo-)Plato
Epinomis 61, 220, 233
Epistle VII 22
- Platonism 38, 340
- Pleiades 99, 133
- Pliny the Elder
Natural History 48, 294
- Plotinus 9, 12, 237
 astrology and 238–39
 daimon and 238–46
Enneads 220–21, 238–39, 242, 268–69
 on passions 239–40, 244
 ship metaphor in 243–45
- Plutarch of Chaeronea 11, 237, 384
Amatorius 348, 344n19
 brief biography 17–18
*De defectu oraculorum (On the Decline of
 Oracles)* 20–21, 122n36, 123nn37, 39,
 337n100
 Cleombrotus in 20
*De facie quae in orbe lunae apparet (On the
 Face in the Moon)* 21, 25–28, 305n9,
 344–45
De fortuna Romanorum 50n17
*De genio Socratis (On the daimonion of
 Socrates)* 17, 21–25, 27n41, 34, 41n89,
 236, 382–83
 Myth of Timarchus 23–25, 382–83,
 391
De Iside et Osiride (On Isis and Osiris)
 78nn2, 3, 104n129, 123n39, 155n188, 162,
 177, 194, 241n28
De superstitione (On Superstition). *See also*
 δεισιδαιμονία 19
Moralia 18–19
Parallel Lives 19, 33, 47, 390
Platonic Questions 21, 44
Quaestiones convivales 345
The Generation of the Soul in the Timaeus
 21
- (Pseudo-)Plutarch
De fato (On Fate) 28–33, 43, 49, 61, 91,
 103, 221
Placita 123
- Polybius 48
- Poros (Provision) 346–47
- Porphyry 3, 9, 12, 352
 and Antiochus of Athens 65, 188,
 256n86, 264, 267–71, 439–41
 astrology and 236, 238, 251, 266–73,
 275
Commentary on Ptolemy's Harmonics
 268n125
Contra Christianorum 268n125
 dialogue with Iamblichus in *DM*
 247–53
Introduction to the Tetrabiblos 65,
 226n146, 227n147, 236, 254–56, 258n94,
 266–67, 271, 395, 439–45
Letter to Anebo 153–54, 224, 236, 247,
 254–55, 267, 274, 394
Life of Plotinus 236n3, 238–39
On Abstinence 122, 142, 212n72, 237n7,
 254, 394
 on the bad daimon 142
 on the daimon and astrology 238,
 248–49, 251, 254, 257n90
 on *heimarmenē* 266n122, 274–75, 391
 on the lord of the nativity 270–73

- on the *oikodespotēs* 12, 236–37, 248–49, 251n61, 255–58, 263n110, 267–68, 270–71, 424, 428, 430, 439–45
 on the personal daimon 3, 9, 12, 236–38, 242, 248–49, 251, 255, 257, 268, 270, 274–75
 on the soul's passage into life 240–42, 255, 285–86
On Statues 253
On the Cave of the Nymphs in the Odyssey 159, 170, 182–83, 188, 254, 268n125, 273–74
On What is Up to Us 9, 209–10, 240, 251n61, 254–55, 258n90, 266n122, 270, 285
Philosophy from Oracles 254
 relationship with Iamblichus 238
 student of Plotinus 238, 242n30
To Gaurus on how embryos are ensouled 269–70
 Poseidon 280
 Posidonius 27, 126, 150
 on happiness and the daimon 59, 124
 Posidonius of Halicarnassus 47–48
Potter's Oracle 79, 83–84
 Praxidike 233
 Prince Hornakht 215
 Proclus 133n100, 352–53, 394
 Commentary on Plato's Republic 236, 286
 On Alcibiades I 246
 on astrology 237–38, 286
 on the daimon 236n3, 246, 270, 286, 391
 Prometheus 342, 345
pronoia, providence. *See also* *πρόνοια* 22, 30, 38, 44–45, 91, 349, 352, 381, 391
 chronical (tertiary *pronoia*) 44
 Eros and 357
 Iaoth and 177
 in Valens 33–34, 36–40, 42–45
 Isis and 91
 kairical (primary *pronoia*) 44
 moon and 37, 177, 306
 three levels of 30–33, 44–45, 382
 Protogonos 351–54, 385
 Pseudo-Callisthenes 80
 Alexander Romance 85, 136, 235
 Ptah 78, 217, 351
 Ptolemy III 79
 Ptolemy VI Philometor 53, 102
 Ptolemy, Claudius 17
 on length of life 65–66, 154, 287, 330–31
 on the *oikodespotēs* 253, 258–60, 265, 435
 on astrological places 65–66, 154, 227
 views on astrology 238
 Pyramid Texts 100, 199
 Pythagoras 123–24
 Pythagoreanism 340
 Qumran 129, 131
 Ramses I 96
 Re (deity) 121, 198, 199
 Renenet (Egyptian divinity). *See also* *rmn.t*, *rnnwtt*
 Agathe Tyche and 79–80, 101–02
 description of 47, 79, 100–101
 fortune and 90, 101–02
 in *Book of the Dead* 96–97
 Isis and 87, 90, 106, 390
 Renenwetet and 100
 Shai and 47, 79, 90, 95–98, 100–01, 106, 121, 215, 390
 snakes and 79, 100
 temple to Thermouthis 87
 Thermouthis and 79–80, 87, 100–01
 Renenwetet. *See* Renenet (Egyptian divinity)
 'Report of Wenamun' 105, 110
 Reret (deity). *See also* Shepset 101
 Rhea 88, 352, 354
 Rhetorius
 on astrological places 60, 74–76, 127, 145–46, 148–49, 151
 on lots 279, 288, 309–10
 on the *oikodespotēs* 258, 265–66
 Rhetorius (cont.)
 on the place of acquisition 68n109
 planets in 146, 148–49
 Sabaoth (decan god) 231–32
 Sabbadaios. *See* archons, Sabbataios
 Sabbath 134, 170
 Sabbede. *See* archons, Sabbataios
 'Sacred Book of Hermes to Asclepius' 136, 219
 Saft el-Henna Naos. *See* Naos of the Decades
 Sakhmet 217
Salmeschiniaka 223
 and P. Oxy. 465 224

- Salonika 87
- Sambathon 169
- Sarapis 206, 233
 Agathos Daimon and 47, 77–80, 94–95, 101, 203, 390
 as Helios 78
 description of 78
 Dream Oracle ('Sarapis Aretalogy') 202–03
 fate and 106, 202–03
 Isis and 78–81, 94–95, 390
polis god of Alexandria 79, 82
 snake form of 79
- Satan 128, 134, 137, 177
- Semele 45
- Septuagint 57, 129–30, 137, 390
- Serapion (astrologer)
 on astrological places 76
 on length of life 331
 on lots 308
 on the *oikodespotēs* 258, 263
 on planets 153–54
- Set (Egyptian deity) 78, 84
- Seth, Sethian, Sethianism 171n59, 176n73
- Seti I 351n57
- Setne Khaemwas 54, 100
- Seven Hathors 98–99
- Sextus Empiricus 238
- Shādhān (student of Abū Ma'shar)
Mudhākarāt 231
- Shai (Egyptian divinity). *See also* ššy, šy
 11th Demotic place 53–56, 218, 315–16
 Agathos Daimon and 11, 77, 79–85, 95, 98, 100–01, 107, 205–07, 219, 315, 391
 death and 105–7
 fate and 47, 55–56, 77, 79, 83–86, 90, 95–98, 100, 103–05, 109–10, 218, 391–92
 four *kas* and 205
 in *Book of the Dead* 96–97
 Meskhenet and 95–98
 Renenet and 47, 79, 90, 95–98, 100–01, 106, 121, 215, 390
 Shepset and 53–56, 88, 95, 98, 101, 115
 snake form of 53, 55, 79, 83, 96, 100, 103, 218–19, 316
- Shepset (Egyptian divinity). *See also* špšy.t, špšy 112
 5th Demotic place 53–56, 102–03
 Agathe Tyche and 102
 description of 53, 101–02
 fortune and 56, 61, 101–02, 115
 Isis and 88–89
 Shai and 53–56, 88, 95, 98, 101, 115
 wealth and 61, 88
- Sheshonq 106
- Shu 104, 217, 230, 351n57
- Simplicius 237
- Sin (moon god) 118, 307
- Sirens 347
- Sirius 89, 99, 178, 188
skhent (double crown) 80, 86
 slaughtering demon. *See* demon, Egyptian, fighters; *sšr*; *hštyw*
- Socrates 24, 33
- Socrates' daimon/*daimonion*. *See also* *daimonion* 2, 18, 21–25, 33
- Solomon 131–32, 139, 222
- solstices 183
- Sophocles
Ajax 382
- Sothis. *See* Sirius
- Spdt* (*Sopdet*). *See* Sirius
- Spenta Mainyu 161
- spirit. *See also* πνεῦμα; 𐤍𐤍 4, 42n90, 95n84, 98n92, 129n78, 148, 195n6, 204, 236, 241n27, 300–01, 305, 335, 338, 340–41, 348, 383–85, 388
 bad, evil 5, 112, 122, 128, 133, 137n117
 Egyptian
akh. *See also* 𐤉.w, 𐤉y 218
 good 5, 112, 161n11, 242, 248, 298, 306
 in Gnosticism 162–63, 170, 173
 Jewish
šēdīm 128–29
 local 5
 Mesopotamian 110–12
ilu 111
ištaru 111
lamassu 111, 392
šēdu 111
 protective 111–12, 215n86, 392
- Stoic, Stoicism 38, 289, 347, 354–55, 395
- Strabo
Geography 78
- Suada. *See* Peitho
- sun 89, 131, 163, 249, 340–41
 and right eye of Horus 205
 blinding light of 21

- Clotho and 27
 god and 21
 in Magical Papyri 196–200, 204–06
nous and 45, 211
- Sun (astrological) 36, 45, 133, 153, 165, 193,
 223, 268–72, 286, 290, 297, 299, 305–8,
 322–23, 328–36, 338, 355, 403–04,
 406–11, 423–27
 and right eye 205
 daimon and 50, 218
 decans and 234
 lao and 165, 169–70, 172
 in Mithraism 182–83
nous and 218
oikodespotēs and 256, 259–66
 planetary orders and 168–77
 significations of 21–22, 25–27, 148–51
 soul and 240n41, 305
Thema mundi and 186–89
- sympathy, *sympatheia* 273
 synastry 359
 Synesius 125–26
 Syrians 87
- Tablettes de Grand (Grand Tablets).
 See boards, astrological; *pinax*
 (astrological board)
- Tabula Cebetis* 49
- Tacitus
Histories 78
- talisman 222
- Tecmessia 382
- Tefnut 104
- Tellurus 295
- ‘Tenth Book of Moses’. See also PGM XIII
 (Citations Index) 204
- terms/bounds, astrological 121, 180, 257,
 259–60, 264, 407–10
- Testament of Solomon* 132–33, 136, 219–20,
 222
- Tethys 233
- Teucer of Babylon
 on decans 226–27
- Thales 124
- ‘The Instructions of Ptahhotep’ 106
- ‘The Old Coptic Horoscope’ 177
- ‘The Tale of the Doomed Prince’ 77, 99, 110
- Thebes, Egypt 204
- Thema dei* 185–90, 192–93, 393
- Thema mundi* 68, 178, 182, 184–90, 192–93,
 393, 414
- Themis 51–52, 86, 233, 413
- Themistocles 380
- theogony
 Orphic 345, 350–54, 379
 Hieronyman 351, 354
 Protogonos 354
 Rhapsodic 350
- Theophilus of Edessa 257n87
- Theosebeia (alchemist) 139
- Thermouthis. See Renenet (Egyptian
 divinity)
- Thessalus of Tralles 136
- theurgy 163, 247, 249, 253, 273, 275, 394
- Thracians 87
- Thrasyllus, Tiberius Claudius
 on astrological places 64, 140–41, 143
 on the *Thema mundi* 184–85, 187
- ‘Three Stars Each’ (Babylonian text) 214
- Tiamat 116
- Tiberius 64, 279, 402
- Titanic, shipwreck of 245
- Titans 351
- Tjenenet 98
- Tolma 233
- Trier Monument 192
- triplicity, astrological 256, 259–60, 264, 403,
 407–10
- Tyche. See also Agathe Tyche (deity) 50, 82,
 106, 129–30, 288, 321, 352
 at Khirbet et-Tannur 78, 92–95, 178
 cultural pair with Daimon 46–50
 in Magical Papyri 196–98
 Isis and 86
- Tyche of Antioch 82, 130
- Tyche of Dura 94
- Typhon 58, 78, 83–84
- Valerius Heracles 386
- Verecundus 61
- Vettius Valens 11, 239
 birthchart of 35
 brief biography 17–18
 derived places in 68
 Moon as *pronoia* in 37, 177
 negotiating fate and 39, 336
 on astrological places 67–69, 140, 143,
 200n28, 262

- Vettius Valens (cont.)
 on *heimarmenē* 37–43, 245–46
 on *katarchē* 40–42
 and *kairos* 40–41
 on length of life 107, 330
 on the Lot of Basis 309–10, 327–29
 on the Lot of Daimon 313–14, 317, 319–36
 on the Lot of Eros 318, 323, 348, 353,
 356–58, 361, 364–67
 on the Lot of Fortune 200n28, 262,
 313–14, 317–36
 on the Lot of Necessity 318, 323, 348, 353,
 356–58, 361, 364–67
 on lots 286, 288–89, 307–08
 on melothesia 313–14
 on the *oikodespotēs* 258, 260–62, 266, 272
 on the personal daimon 34, 36–43, 391
 on planetary days of the week 169
 on planets 67, 262
 on profections 323–27, 357–58
 on *pronoia* 33–34, 36–40, 42–45
 on the *Thema mundi* 68
 shipwreck in 244–46
 views on astrology and fate 238n14
 visit to Egypt 347
vores magicae 197, 206
 ‘Vohu Manah’ (Good Thought) 161
 Vulcan 295, 386
- world-lords. *See* κοσμοκράτωρ
- Xenocrates 122–23, 126, 337
- Yabel. *See* angels, Gnostic, Yobel
 Yaldabaoth. *See* archons, Ialdabaoth
 Yobel. *See* angels, Gnostic, Yobel
- Zamoktar (Persian astrological technique)
 376
 Zamolxis 161
 Zarathustra 161, 232
 Zathraustes. *See* Zarathustra
 Zeus/Jupiter 34, 45, 50–52, 54n35, 56, 58n54,
 60, 62–63, 65n94, 70–72, 74, 78, 85n39,
 134, 153, 163n20, 168–70, 172, 174–75,
 179–80, 187, 234, 241n27, 256, 280–81,
 287, 293, 295, 297–99, 311, 315, 319, 322,
 325–27, 329, 342, 345, 351–52, 354–55,
 357, 368–71, 376, 387n178, 399, 403–04,
 407–09, 413, 415, 418–19, 423, 426, 429,
 431–32, 434, 437–38, 447–48, 456–57,
 470–71, 474, 480–82
 Zeus Ktesios 51–52, 56, 63, 65n94, 85n39
 11th place and 52, 56, 63
 Zeus Meilichios 52, 473–74
 wealth and 52
 Zeus Philios 52
 zodiac 252
 at Khirbet et-Tannur 92–93
 daimonic degrees of 153–55
 directions of 92, 178, 186, 192, 399
 signs of 68, 148, 164, 185n118, 188n128,
 205, 209–11, 216, 222, 233, 235n183, 249,
 321–22, 353, 399, 413–14
 air signs 225, 402, 408
 as places 64, 73, 75, 148, 151, 357n91,
 400
 earth signs 225–26, 402, 408
 familiarities of 359, 405, 453
 feminine signs 449
 fire signs 225, 329, 402, 408
 fixed (solid) signs 154, 190, 317, 402
 in Gnosticism 172–80
 in Mithraism 182, 191–92
 lunar (nocturnal) signs 179, 190,
 192
 masculine signs 449
 mutable (bicorporeal) signs 69, 317,
 402
 solar (diurnal) signs 179, 186, 192
 tropical signs 69, 190, 317, 402
 solstitial/equinotial 69, 154,
 179n88, 183n108, 402
 unfortunate last degrees of 154
 water signs 225–26, 402, 408, 453
 tropical 399
 Zoroaster 161
 Zoroastrian, Zoroastrianism 128–29, 131,
 160–62, 351, 352
 astrology in 232, 234
 Thema mundi and 185, 190
 Zosimus of Panopolis 138, 139
 Final Receipt 139
 On the Letter Omega 139

Selected Citations Index

Abū Ma'shar

Abbreviation 1

Ch. 6, 6 and 8	365n110
Ch. 6, 44	377n146
Ch. 6, 8	387n179

Abbreviation 2

Ch. 6, 44	377n146
Ch. 6, 8	387n179

Great Introduction

VIII, 3.10	314n41
VIII, 3.15–16	365n110

Greater Introduction

VIII.333–334	313n41
VIII, 3.420–449	365n110
VIII, 3.444–49	387n179

De revolutionibus nativitatium

I, 5, 8	376n138
III, 1 (Zamoktar)	376n138
III, 1 (chart)	377, 377n144
III, 1 (chart)	377n145
III, 1 (chart)	376n142
III, 1 (chart)	378
III, 1 (chart)	480–82

Alexander of Aphrodisias

De anima

20.29	269n130
-------	---------

Al-Qabiṣī

Introduction

V, 4	313n41
V, 4–5	365n111

Antiochus of Athens

Thesaurus

CCAG I, 157.14–15	65, 65n90
CCAG VII, 127.24–26	21, 21n16
CCAG VIII/3, 104–19	257n87
Ch. 10	229n157
Ch. 32	256n86
Ch. 44, CCAG I, 159.20–29	407n18
Ch. 47, CCAG I, 160.11–28	447
Ch. 47, CCAG I, 160.12–16	8n28, 27n44

Ch. 7, CCAG I, 147–48	408n22
Prooemium, CCAG I, 142.4–143.10	399n2

Introduction

CCAG VIII/3, 104–19	257n87
CCAG VIII/3, 117.7–9	65, 65n92
CCAG VIII/3, 117.16–17	65, 65n94
CCAG VIII/3, 118.9–12	268
Ch. 5, CCAG VIII/3, 113.14–22	256n86
Ch. 25, CCAG VIII/3, 117	400n5
Ch. 28 (29 Cumont)	270
Ch. 28 (29 Cumont), CCAG VIII/3, 118.9–22	439

Anubio

Carmen Astrologicum Elegiacum

6 ii.41–44	73, 73n124
Frs 1 and 2	227n149, 251n65

Apuleius

De deo Socratis

XV.151	22n19
--------	-------

Metamorphoses

XI, 6	106, 106n143
XI, 12	91n61

De Platone

I, 12	29n50
-------	-------

Aratus

Phaenomena

239–45	355
560, 581, 716, 721, 740	413n34

Aristophanes

The Birds

695–696	352, 352n67
---------	-------------

Aristotle

The Athenian Constitution

8.1–2, 22.5, 26.2, 55	281n14
-----------------------	--------

Aristotle (cont.)

The Athenian Constitution

58–59 281n13

Eudemian Ethics

1214a 209g

On Generation and Corruption

II, 2–8 133

Nicomachean Ethics

1097a–b 209g

Physics

2.4 383n164

Prior Analytics

I.36, 48b36 44n99

Artemidorus

Oneirocritica

5, 92–94 78n3

(Selected) Astrological Papyri

Louvre N 2342 426

Louvre 2342 426

P. Berlin 9825 367, 376

P. Lond. 98 425

P. Lond. 110 426

P. Lond. 130 346n31, 424

P. Mich.inv. 1, 149 152–155

Col. ix.1–25 143

Col. ix.16 61n72, 141

Col. ix.16, 19–20 65n89

Col. ix.20–27 400n5

P. Oxy. 235 402n11, 423

P. Oxy. 465 224n136

P. Oxy. 4245 234n173

P. Oxy. 4270 370n130

P. Oxy. 4277 234n173, 346n31,

368n124, 370–72,

370n130, 375n137,

478–79

P. Oxy. 4278 428

P. Oxy. 4279 370n130

P. Oxy. 4280 234n173

P. Oxy. 4283 234n173

P. Oxy. 4284 234n173, 370n130

P. Oxy. 4285 234n173

P. Oxy. 4286 370n130

P. Oxy. 4295 370n130

P. Princeton 75 367–68, 427, 477

PSI 23,a 369–70, 477–78

Athenagoras

Plea for the Christians

(Legatio pro Christianis)

XX.2 354, 354n80

Bacchylides

3.35–38 26n37

Balbillus

CCAG VIII/4, 236.8–23 279

Bible

Old Testament

Deuteronomy

32:24 128n62

Habbakuk

3:5 128n62, 128n63

Isaiah

65:11 129, 129n74,

390

Psalms

91 128n62

Bible

New Testament

Matthew

21:33–41 255, 255n81

Mark

5:12 137

Luke

8:29 137

Epistle of Paul to the Ephesians

6:12 134n101

Bonatti

De astronomia

Tractate 4 (= Book 8), 365n114

Part 2, Ch. 2, col. 631

Book of Enoch

Astronomical Book

Chs 72–82 131–32

Book of the Watchers

1 En. 1–36 139

1 En. 6.2 131

1 En. 8.3 132

1 En. 18.14–16 132

1 En. 21.1–10 132

Calcidius*Commentary on the Timaeus*

143a–144a 29n50

(Pseudo-)Callisthenes*Historia Alexandri Magni*

I, 4.5 235n183

I, 4.6 136n113

I, 32.6–13 85n37

Catullus*Poems*

64.327, 333, 337, 342, 389, 389n1

347, 352, 356, 361,

365, 371, 375, 378, 381

Censorinus*De die natali*

8.5 414,

414n38

Chaeremon*Fragments*

Fr. 5 274n149

Cicero*Aratea*

Fr. 33.17 355n85

De divinatione

I, 34.75–76 280, 280n11

II, 18.42 294

De natura deorum

I, 20.55 381n158

Clement of Alexandria*Stromateis*

V, 14.138.1 344n23

Coptic Astrological Texts

The Old Coptic Horoscope

Line 135 177, 177n81

'Coptic Book'

Fr. no. 128 166n32

Cornutus*Theologiae Graecae compendium*

27.4 52n27

Court de Gébelin, Antoine'Allégories Orientales', in *Monde Primitif*

vol. 1, 109–10 386n173

vol. 1, 113 386, 386n173

Damascius*De principiis*

1.318.1–4 352n66,

353–54n76

i.318.5–6 351, 351n56

Demotic Egyptian Texts*Archive of Hor*

O. Hor 3.3r 53

O. Hor 3.4r 53

O. Hor 3.3–4r 102n118

O. Hor 3.5r 53, 89

O. Hor 3.12r 53

O. Hor 3.12–13r 53

O. Hor 3.14r 53

O. Hor 10.8–9 88n49

'Demotic Plea to Thoth' (Michaelides)

ll. 6–8 53–54,

54n34

Instruction of Ankhsheshonq

14.17 208n58

O. Glasgow D.1925.96

ll. 14–15 55n43

OMM 134 ll. 7–14 315, 316

ll. 13–14 316

'Ostrakon 3' (Neugebauer 1943)

(Thompson 1 + O. Stras. 1566)

l. 16 79n62

l. 17 141, 141n137

l. 21 57, 57n54

l. 22 315, 315n48

ll. 13, 19 304n7

ll. 14–18, 20 304n7

ll. 22–23 54, 54nn37, 38

'Ostrakon 5' (Neugebauer 1943)

(Thompson 2)

ll. 1–7 55

ll. 6–8 55n42

ll. 6–9 54–55

P. Berlin 8345 53n33,

I, 1 102n118

II, 1 54n34, 141,

141n138

- P. Berlin 8345 (cont.)
 III, 1 55, 55n45
 III, 2 56, 56n46
 III, 11 102n118
 IV, 10 55, 55n45
 IV, 11 56, 56n46
 IV, 15 54n34, 141,
 141n138
 53n33
- P. Carlsberg 81
- P. Insinger
 2, 20; 5, 11 et al. 102n118
 5, 1 114, 114n186
 PSI inv. D. 34 53n33, 54n35
- P. Vindob. D. 6614
 a4, 8, 12 57n54
- Rosetta Stone
 Dem. 21 102n118
- 'Setne Khaemwas II'
 2, 26 54, 54n39
 3, 27-28 100n106
- Dio Cassius**
Roman History
 37.18-19 169n50
- Diodorus Siculus**
Bibliotheca historica
 I, 27.4 86n43
 I, 89.3 110n166
 I, 94.2 161n12
- Diogenes Laertius**
Lives of the Philosophers
 5, 76 78n3
- Dorotheus of Sidon**
Carmen Astrologicum
 I, 12 256n85
 I, 15 449n1
 I, 24.5-6 63, 63n84,
 279, 311
 I, 25.8 62, 62n83
 I, 26 310
 I, 26.31 62, 62n80
 I, 26.31 ap. Heph. II, 18.15 67n105
 I, 5.1-5 ap. Heph. I, 12.1-2 62n78
 I, 5.2-3 55n43, 62,
 62n77
 I, 5.5 143, 145n146
- I, 9 287-88
 I, 9 ap. nat. Const., III, 2 288n29
 II, 8 62
 II, 12.16 62n81
 III, 1 and 2 258
 III, 1.70 126, 126n55
 III, 2 ap. Heph. II, 26 260, 272
 III, 2.19-25 259, 259n97
 III, 2.2 259, 259n95
 III, 2.27 108, 108n148
 Scholium ad Heph. 367, 367n117,
 III, 6.11 388n180
 IV, 1 146n148
 IV, 1 (gr.) 310n29
 IV, 1.1-64
 V, 17.2 311n31
 V, 17.2-3 62n82
 V, 17 ap. Heph. III, 11.2 311n31
 V, 33 256n85
 V, 37.1-8 140n133
 V, 41 256n85
 ap. *Liber Hermetis*
 (pars Cupidinis) 359, 359n99,
 360, 360n101
- (Selected) Egyptian Texts**
Admonitions of an Egyptian Sage
 I, 7 104
 BM 70 90, 90n58
 BM 1162
 B.3 90, 90n58
 B.6 106n143
 Funerary Chapel of Ramesses I, Abydos
 L. 3 96, 96n87
The Instructions of Ptahhotep
 33 106, 106n141
 P. Harris 500
 (*The Harper's Song of Intef*)
 vi, 2 105, 105n140
 P. Harris 500 verso
 (*The Tale of the Doomed Prince*)
 8.5 77, 77n1, 99,
 99n104
 P. Leiden I 350
Hymn to Amun
 III 17-18 105, 105n137
The Report of Wenamun
 II, 55-60 105n136

- Eliot, George**
The Mill on the Floss
 VI, 6 1, 1n2
- Empedocles**
 Fr. B43 26n35
 Fr. B115 123n40
 Fr. B116 345, 345n26
- Epictetus**
Manual
 1 298n64
- Ficino, Marsilio**
Liber de vita coelitus comparanda
 23 263n110
 23,27-29 236, 236n1
- Firmicus Maternus, Julius**
Mathesis
 II, 4 228
 II, 4.1 227
 II, 4.4-5 227, 251
 II, 14 144, 400n5
 II, 22.8 69, 69n112
 II, 16.1 70, 70n115
 II, 17 144
 II, 19 144, 401n10
 II, 19.6 70, 70n116, 117
 II, 19.7 142
 II, 19.7, 13 142n140
 II, 19.12 70, 70n118
 II, 27-28 323n65
 III, Intro.4 185, 186n120, 187, 187n122
 III, 1 185, 185n118, 186, 414
 III, 1.1 187, 201n54
 III, 1.9 187n123
 III, 1.10 187, 187n124
 III, 1.15 187n1123, 124
 III, 2-13 70
 III, 7.10 60n65
 III, 9.6 147, 147n152
 IV, 1.6 305, 305n10
 IV, 16.12 460
 IV, 17.1-12 461-66
 IV, 17.5-6 311-12, 312n35
- IV, 18.1 466-67
 IV, 18.2 312-13, 313n36
 IV, 19.1 262, 262n109
 IV, 19.2 262
 IV, 19.3 263n110
 IV, 19.4 263
 IV, 22 228n151
 IV, 22.2 219n113, 228, 228n1152, 153
 VI, 1.3 73, 73n128
 VI, 29 73
 VI, 30 70, 73
 VI, 30.23 71, 71n119
 VI, 31 73
 VI, 31.24 71, 71n120
 VI, 31.84 72, 72n123
 VI, 32.45 363, 363n107
 VI, 32.45-46 288n31
 VI, 32.46 363, 363n108
 VI, 32.56 288n31, 309nn25, 26
 VII, 23.7 73n126
 VII, 23.17 73n127
- Freud, Sigmund**
Zur Dynamik der Übertragung,
 in *Gesammelte Werke*, Band 8
 364-65, n. 2 303
The Dynamics of Transference,
 in *Complete Works*, vol. XII
 99, n. 2 303n1
Das Unbehagen in der Kultur
 64 339
Civilization and its Discontents,
 in *Complete Works*, vol. 21
 101 339n1
- Galen**
De usu partium
 X, 12 34, 34n63, 34n64
 X, 14 34n63
De consuetudinibus
 IV 34n65
De simpl. medicam. temperam ac facult.
 VII 225n139

Geminus*Introduction to the Phaenomena*

I, 6 413n36

Gnostic Texts*Apocryphon of John*

NHC II, 11,26-34/ 166

BG 41,17-42,6/

NHC IV 18,17-23

NHC II, 11,26-34/ 172

BG 41,16-42,7/

III 17,21-18,8

II 10,28-11,3/ 174-75

III 16,20-17,5/

BG 40,4-18

III 17,20-21/ 173

BG 41,16-17

Gospel of Judas

TC 52,4-14 175-76

*Holy Book of the Great Invisible Spirit**(Gospel of the Egyptians)*

III 58,7-22; IV 70,1-5 174-75

On the Origin of the World

NHC II, 5 100.20-24 166

101.27-28 169, 169n43

101.25-102.2 166

101.25-102.5 134n104

106.27-107.3 134n104

124 132n92

Pistis Sophia

I, 1 180n96,

251n64

I, 8 180n96, 251n64

I, 45,8 180, 180n96,

251n64

II, 93 (213.12-14) 181, 181n97

II, 93 (215.3-5) 181, 181n98

III, 126 172n64

III, 131 181, 181n99

IV, 36 179n91

IV, 136 180, 180n92,

180n96, 251n64

IV, 136-137 163n20

IV, 137 180n93

Hephaestio of Thebes*Apotelesmatica*

I, 1.13 229, 229n158

I, 1.109 264, 264n116

I, 12 144

I, 12.1 62n78, 145n146

I, 13 264

I, 13.1 256n86

I, 13.2 253n70, 264,

264n113, 114

II, 1.32-34 35n71

II, 2.22-26 35n71

II, 9 288n28

II, 10 144, 150n165,

288n28

II, 10.14-16 150-51, 151n167

II, 10, 42, 45 154n181

II, 11 331

II, 11.3 66n99

II, 11.6-7 35n71

II, 11.23-25 331n81

II, 11.32 434n13

II, 16.3, 5-6 140n133

II, 18 429

II, 18.15 67, 67n105

II, 18.22 430

II, 18.25-26 430

II, 18.54 429

II, 18.63 - 64 432

II, 18.74-75 112n178

II, 18.74-77 230, 230n160

II, 23.10-11, 16 359, 359n98

II, 26 258, 272

II, 26.32 264, 264n115

II, 27-28 323n65

III, 4.3 67n102

III, 6.11 248n53, 360,

360n103, 388n180

Scholion to III, 6.11 ap.

Dorotheus 366-67, 366n116,

367n117

III, 7.13-18 254n74

III, 9 317n50

III, 10 317n50

III, 11.2 62n82, 311n31

III, 36.3 66n101

Epit. I, 45.3 66n101

Epit. IV, 25.47-48 434n13

Epit. IV, 26.65 230n159

Heraclitus

Fr. B19 1, 162

Hermetica*Asclepius*

Prologue, 1	349, 349n44
5,6–9	213, 213n74
19	210, 221, 221n126, 221n127, 222n128, 225n139
21	349, 349n45
35	286

Corpus Hermeticum

X, 7.10–13	192–93, 193n138
X, 23,5–6	162n13
XVI, 10.3–5	220, 220n118
XVI, 10 and 13	220
XVI, 13	210n65
XVI, 13,5–6	29, 29n51
XVI, 13,5–7	209, 209n62
XVI, 15,1–5	210, 210n64, 210n65
XVI, 15,8–9	211, 211n69
XVI, 16.4–10	123, 123n38, 212, 212n73
XVI, 17.1–7	211, 211n70
XVI, 18.1–4	211, 211n70

Stobaei Hermetica

VI, 1	220
VI, 3	221, 221n121
VI, 6	221
VI, 6.6–7	221, 221n122
VI, 10	221
VI, 10.6	221, 221n124
VI, 11.3	221, 221n123
VI, 12	221, 221n125, 251, 251n63
VI, 13	252, 252n68
VIII	381, 381n59
VIII.1	382n160
VIII.2–4	382n161
VIII.5–7	382n162
XIII	349, 349n46
XXIII.28	349, 349n47
XXIII.38	350, 350n48

Herodotus*Histories*

II, 3	78n2
II, 42	78n2
II, 50	78n2
II, 59	78n2

II, 82.1	101n15
II, 144	78n2
II, 156	78n2
VIII, 111.2	380, 380n153

Herrick, Robert*Poetical Works*

<i>The Departure of the Good Daemon</i>	46, 46n1
---------------------------------------------	----------

Hesiod*Theogony*

120	342, 342n9
201	342n10
507–511	342n11
517	342n11
615	342n11

Works and Days

121–123	98n97
121–126	5n19
252–255	5n19, 98n97

Hipparchus*Commentary on the Phaenomena of*

<i>Aratus and Eudoxus</i> s.v. μείρα	413n35
-----------------------------------------	--------

Homer*Iliad*

VI.458	342n12
VII.171–199	280n8
X.252–253	413, 413n37
XV.187–193	280n8
XX.95	22, 22n20

Odyssey

XIX.34	22n20
--------	-------

Homeric Hymns

<i>To Aphrodite (I)</i>	342
-------------------------	-----

Hugo of Santalla*Liber Aristotilis*

II, 16, 3–13	436n15
III i 10	259n97

Hyginus*De astronomia*

II, 7	381n56
-------	--------

- Iamblichus**
Commentary on Timaeus
 Fr. 87 269n130
- De mysteriis*
 III.1, 99 247
 III.26 269n130
 III.29 355n85
 V.23 253, 253n72
 VIII.4 248, 248n52, 251n62
 IX.1–3 9n35
 IX.1 248–49, 249n56,
 273
 IX.2 249, 249n57
 IX.3 267n122, 274n150
 IX.4 238, 267n122
 IX.5–10 9n35
 IX.5 248, 248n54, 252–53,
 253n69, 267n122
 IX.6 242, 242n29, 246n48,
 250, 250n58
 IX.7 237n6, 250, 250n59,
 272
 IX.8 124n43
 IX.9 133n100
 X.4 247
- Ibn Ezra**
The Beginning of Wisdom
 Ch. 9 365n113
The Book of Reasons
 Ch. 7.1.10–11 365n113
- Irenaeus**
Against Heresies
 I, 30.4 169, 169n44
 I, 30.5 166, 167n37
 I, 30.9 165n30, 169n44
 I, 30.10 169n44
- Isaeus**
 8.16 52n26
- Isis aretalogies**
 Hymns of Isidorus
 I.1–3 88, 88n48
 I.15–22 87–88, 88n47
 II.1–2 88n48
 II, 9 84n35
- III.1, 19 88n48
 IV, 5 84n35
- Kyme Aretalogy**
 ll. 9, 12–14, 44–45 89, 89n50
 ll. 4, 9, 12–14, 16,
 28–29, 35, 38,
 44–48, 52, 55–57 420–21
 P. Oxy. 1380 91n61
- Julian**
Chaldean Oracles
 Fr. 39 350n49
 Fr. 42 350n49
 Fr. 44 350, 350n49,
 350n50
 Fr. 88 163n25
 Fr. 90 126, 126n52,
 163n25
 Fr. 91 126, 126n52,
 163n25
 Fr. 135 126, 126n52,
 163n25
 Fr. 156 126, 126n52
 Fr. 149 163n25
 Fr. 157 163n25
- Julian the Emperor**
Oration to the Sun
 132c–133d 212n71
- Julian of Laodicea**
 in *CCAG* IV, 104.29–105.1 67, 67n103
 in *CCAG* VIII/4, 252.6–22 254n74
- Jung, Carl**
Memories, Dreams, Reflections
 356 279, 279n1
*Synchronicity—An Acausal Connecting
 Principle*
 85 338, 338n102
- (Pseudo-)Libanius**
Descriptiones
 12.25 82n24
- Liber Hermetis**
 Ch. 1 232
 1.5, 25–32 231, 231n166
 Ch. 16 232, 279n5

- 21.13 359–60, 360n101
 Ch. 36 73
 36.6 73n126
 36.13, 59–60 316n50
 36.17 73n126
 36.20 73n126
 36.23 73n127
 36.24 127, 127n56
 36.32 144
 36.42 144
 36.45 144, 149n159
- Lilly, William**
Christian Astrology
 715–33 323n65
- Macrobius**
Commentary on the Dream of Scipio
 1, 6.37–40 36n73
 1, 12.14 241n27
 1, 19.2 404n15
- Saturnalia*
 1, 17.42 353n72
 1, 18.12–22 353n72
 1, 19.16–18 340–41, 341n6
 1, 19.17 36n73
 1, 20.13–15 78
 1, 23.22 353n72
- Magical Papyri**
Papyri Graecae Magicae
 III.135 133n100
 III.144–45 206n50
 IV.475–575 193n138
 IV.1596–1715 198n18, 204,
 204n41
 IV.1599 133n100
 IV.1605–1609 204n41
 IV.1605–1610 198n18
 IV.1637–43 206, 206n49
 IV.1637–95 195, 205
 IV.1707–11 206n49
 IV.2967–3006 195, 196, 196n9,
 248n53
 IV.3007–3086 138
 V.399 133n100
 VII.505–28 9, 195, 196–97,
 197n12, 248n53
- VII.505 196n11
 VIII.51 196
 VIII.50–52 196n10
 XII.201–69 204
 XII.238–44, 252–57 204n41
 XII.254 205n42
 XIII.1–343 195, 201
 XIII.5–6 201
 XIII.213–24 201
 XIII.343–734 195, 201
 XIII.347–49 201
 XIII.608–14 9, 201, 201n32
 XIII.633–37 9, 202, 202n33
 XIII.646–734 195
 XIII.708–14 9, 202, 202n34,
 210
 XIII.718–30 201
 XIII.734–1077 195, 204
 XIII.761–63, 765–66,
 768–72, 780–83 204–05, 204n42
 XIII.761–83 204n41
 XIII.780–83 205n45
 XIII.1027–39 205n46, 248n53
 XIV.9 205n43
 XV.1–21 48, 48n6
 XVI.1b.1 133n100
 XXI.1–16 204, 204n41
 XXXVI.211–30 198n18, 199
 XXXVI.214–19 205n43
 XXXVI.214–19,
 23–27, 29–30 199–200, 200n25
 XXXVI.216–17 198n18
 XXXVI.230 208n58
 XXXVIII.1–26 205n47
 CX.1–12 136n113
 CX.1–3 208, 208n59
- Papyri Demoticae Magicae*
 xiv.1–114 195, 248n53
 xiv.60 (III, 3) 207, 207n52
 xiv.63 (III, 5) 206, 206n51,
 208
 xiv.63–92 (III, 5–35) 207
 xiv.93 (IV, 1) 207
 xiv.93–114 (IV, 1–19) 207
 xiv.112 (IV, 20) 206n51, 207,
 207n55, 208
 xiv (IV, 21–22) 208, 208n58
 xiv (IV, 22) 208–09

Manetho (astrologer)*Apotelesmatika*

I.7	347n38
I.30	227n149
I.58	227n149
I.134–35	144
I.262	227n149
I.339	227n149
I.347	227n149
III.399–415	331n82
III.406–13	331n82
IV.5–11	252, 252n67
IV.593–96	144
VI	146n148
VI.19	144
VI.35–42	150n165
VI.37	144
VI.41–42	150, 150n166
VI.61	144
VI.151	144
VI.216–21	144
VI.632–33	144
VI.738–50	35n71

Manilius*Astronomica*

1.1–2	56n48
2.788	56
2.856	56
2.856–57	56n47
2.864–70	143, 149, 149n162
2.866	140, 140n135
2.881–84	58, 58n56
2.881–90	415
2.886–88	58, 58n58
2.890	60
2.891–904	415–16
2.891–92	60, 60n63
2.895–96	60, 60n63
2.896	58, 58n57
2.897	60, 60n70, 61, 61n71
2.898–99	61, 61n73
2.903	60, 60n69
2.907–908	60, 60n64
2.938	61n71
2.943	57n50
2.958–59	57n50
3.50–51	290, 290n39

3.64–66	290, 290n37
3.67–85	291n44
3.71–73	290, 290n39
3.75–202	279
3.75–81	290–91, 291n40, 393
3.96	291, 291n43
3.96–155	295
3.96–168	317
3.102–37	292n45
3.138	293, 293n46
3.142–44	293, 293n48
3.149–55	293, 293n49
3.165–67	291, 291n41
3.172	291
3.176–200	296
4.14	248n38
4.107–17	42n92
4.301–302	225n141
4.371	226
4.375	226
4.378–79	226
4.408	226
4.436–38	226

Martianus Capella*The Marriage of Philology and Mercury*

1.45–61	295
1.54	295n57
11.200	251n63

Maximus of Tyre*Orations*

5, 8, 9, 13	49n14
-------------	-------

Menander

Fr. 714	237n6
---------	-------

Mesopotamian Texts*Astrological Reports to Assyrian Kings*

No. 23, rev. 1–6	111, 111n172
------------------	--------------

(Pseudo-)Nechepso and Petosiris

CCAG VIII/3, 100	143
in Firm. <i>Math.</i> III, Intro.4	185, 186, 186n120
in Firm. <i>Math.</i> III, 1.1	207n54
Fr. 18 Riess/Heilen	261n106

- | | | | |
|-----------------------------------|---------------|----------------------------------------|-----------------|
| Fr. +18 Heilen | 257, 257n90 | Origen | |
| Fr. 28 Riess/Heilen | 219, 228n153 | <i>Contra Celsum</i> | |
| (Firm. <i>Math.</i> IV, 22.2) | | VI, 22–31 | 183n111 |
| in Heph. II, 11.23–25 | 331n81, 332 | VI, 28–31 | 162n18 |
| in Val. II, 41.3–4 | 260–61, | VI, 30 | 171n61 |
| | 261n102 | VI, 31 | 166, 170 |
| in Val. III, 11.3 | 287n25 | VI, 32 | 166 |
| in Val. III, 11.3–5 | 333 | VI, 3–32 | 167n37 |
| in Val. IX, 2.7–8 | 287n26 | VIII, 58 | 219n111 |
| in Val. IX, 2.7 | 333, 333n92 | VIII, 58.3–6 | 220, 220n116 |
| Nemesius | | | |
| <i>On the Nature of Man</i> | | Orphic Texts | |
| 43 | 29n50 | <i>Orphicorum Fragmenta</i> (ed. Kern) | |
| | | Fr. 228 | 355, 355n88 |
| | | Fr. 228a | 26n38 |
| | | Fr. 54 | 351, 351n56 |
| | | Fr. 86.4 | 353n71 |
| | | <i>Orphic Hymns</i> | |
| | | Nos 3, 4, 5, 6, 7, 8, | 352n61 |
| | | 9, 12, 13, 14, 15, | |
| | | 26, 28, 33, 43, | |
| | | 55, 59, 60, 61, 62 | |
| | | No. 58 | 352n61, 472–73 |
| | | No. 72 | 352n61, 473 |
| | | No. 73 | 352n61, 473–74 |
| | | 73.2 | 52 |
| | | 73.4 | 52n25 |
| | | Parmenides | |
| | | Test. A 37 | 342–43, 343n18, |
| | | | 381n159 |
| | | Fr. B 1 | 343n18 |
| | | Fr. B 1.14 | 343n18 |
| | | Fr. B 8.30 | 343n18 |
| | | Fr. B8.30–31 | 344, 344n24 |
| | | Fr. B 10.5–7 | 344, 344n23 |
| | | Fr. B 10.6 | 343n18 |
| | | Fr. B 12 | 343, 343n16 |
| | | Fr. B 12.3 | 343n18 |
| | | Fr. B 13 | 343, 343n17, |
| | | | 346n32 |
| | | Paulus Alexandrinus | |
| | | <i>Introduction</i> | |
| | | Ch. 1 | 402n12 |
| | | Ch. 3 | 411 |
| | | Ch. 4 | 229, 229n156 |
| Olympiodorus (the Younger) | | | |
| <i>Commentary on Paulus</i> | | | |
| Ch. 16 | 200n26 | | |
| Ch. 19 | 135 | | |
| Ch. 21 | 297, 297n62, | | |
| | 299, 299n66, | | |
| | 456–57 | | |
| Ch. 22 | 8n27, 297, | | |
| | 297n62, | | |
| | 297–98, | | |
| | 298n64, | | |
| | 298n65, | | |
| | 306n14, | | |
| | 308–09, | | |
| | 309n22, 26, | | |
| | 310n29, 359, | | |
| | 359n96, | | |
| | 367n118, 376, | | |
| | 376n140, | | |
| | 457–59, 480 | | |
| Ch. 23 | 60n68, 74, | | |
| | 74n31, | | |
| | 142n140, | | |
| | 144, 146, | | |
| | 146n151, | | |
| | 151n168, | | |
| | 310n29, | | |
| | 400n6, 401n10 | | |
| Chs 29–33 | 323n65 | | |
| Ch. 34 | 180n94, | | |
| | 453n6 | | |
| Ch. 38 | 154n184 | | |

- Paulus Alexandrinus (cont.)
- | | | | |
|-------------------|------------------------------------------------------------------------------------------------------------------------------------------------------------------|--|--|
| Scholion to Ch. 4 | 227n147, 229n157 | | |
| Ch. 5 | 180n94 | | |
| Ch. 7 | 153n177 | | |
| Ch. 8 | 405n16 | | |
| Ch. 9 | 360m100, 405n16 | | |
| Ch. 12 | 405n16 | | |
| Ch. 13 | 405n16 | | |
| Ch. 21 | 135, 169n51, 201n31,
207n53 | | |
| Ch. 23 | 8n27, 22n22, 27n42,
44, 296n61, 297,
297n62, 306n14,
310n29, 359, 359n96,
366n115, 447–48,
455–56 | | |
| Ch. 24 | 60n67, 74, 74nn130,
131, 132, 142n140, 144,
146n148, 148n156,
150n165, 151n168,
154n184, 310n29,
325n70, 346n31,
400n8, 401n10, 407,
417–19 | | |
| Ch. 30 | 400n6 | | |
| Ch. 31 | 323n65 | | |
| Ch. 32 | 180n94 | | |
| Ch. 34 | 453n6 | | |
| Ch. 36 | 263, 263nn11 | | |
| Ch. 37 | 186nn19 | | |
- Pausanias**
- Description of Greece*
- | | | | |
|---------|--------|--|--|
| I, 22.3 | 38n155 | | |
| I, 43.6 | 50n17 | | |
- Philo of Alexandria**
- Legatio ad Gaium*
- | | | | |
|----|---------|--|--|
| 76 | 188n125 | | |
|----|---------|--|--|
- De providentia*
- | | | | |
|-------|-------|--|--|
| II 70 | 26n35 | | |
|-------|-------|--|--|
- Picatrix**
- | | | | |
|--------------|---------|--|--|
| III, 7.16–33 | 136nn12 | | |
|--------------|---------|--|--|
- Pindar**
- Pythian Odes*
- | | | | |
|-------------|-------|--|--|
| III, 108–09 | 23n24 | | |
|-------------|-------|--|--|
- Plato**
- Apology*
- | | | | |
|-------|--|----------|--|
| 31d | | 19n7 | |
| 40a–c | | 19n7 | |
| 40b | | 21–22n18 | |
- Laws*
- | | | | |
|-------------|--|-------------|--|
| 709b | | 44n99 | |
| 876e4–877b2 | | 49n12 | |
| 876c–877b | | 59 | |
| 757b–758a | | 281, 281n16 | |
- Phaedrus*
- | | | | |
|-------|--|--------------|--|
| 242b | | 22n18 | |
| 247c7 | | 269, 269n130 | |
- Republic*
- | | | | |
|-----------|--|------------------------------|--|
| 488a | | 269n130 | |
| 519e | | 380, 380n154 | |
| 616c | | 243 | |
| 616c–d | | 240 | |
| 616c–617d | | 306, 347 | |
| 616e | | 404 | |
| 616e–617a | | 26n35 | |
| 617c | | 413n33 | |
| 617d–e | | 24n29, 98n97, 282,
283n19 | |
| 618a | | 282–83, 283n19 | |
| 619b | | 283, 283n19 | |
| 619c | | 283, 283n19 | |
| 619d | | 283, 283n19 | |
| 619e | | 19n7 | |
| 620d–e | | 19n7, 98n97, 283,
283n19 | |
| 620e–621a | | 347n35 | |
| 621a | | 283, 283n19 | |
| 621b | | 24n30 | |
- Statesman*
- | | | | |
|------|--|---------|--|
| 272e | | 269n130 | |
| 296e | | 269n130 | |
- Symposium*
- | | | | |
|-----------|--|--------|--|
| 178b | | 346n32 | |
| 180d–182a | | 346 | |
| 195b–c | | 346 | |
| 202d | | 239n19 | |
| 202d13 | | 346 | |
| 202e | | 20n13 | |
- Theages*
- | | | | |
|--------|--|-------|--|
| 128d–e | | 19n7 | |
| 129 | | 19n7 | |
| 129a | | 24n27 | |

- | | | | |
|----------------------------------|------------------------|--------------------------------------------|-----------------------------|
| 129b, d | 22n18 | III, 4.3 | 221, 269n130 |
| 129e | 33 | III, 4.3.6–20 | 242 |
| <i>Timaeus</i> | | III, 4.3.10–14 | 243n35 |
| 37d | 21n14 | III, 4.3.16–17 | 243n33 |
| 38d | 404 | III, 4.3.22–24 | 244, 244n38 |
| 39d | 30n53 | III, 4.6 | 244 |
| 41d–e | 242n33, 285n22 | III, 4.6.10–12 | 243 |
| 42c | 243n33 | III, 4.6.17–19 | 242n33 |
| 47e–48a | 381n158 | III, 4.6.21–23 | 244n38 |
| 48b | 133 | III, 4.6.27–29 | 243, 243n34 |
| 69c–d | 240n21 | III, 4.6.46–47 | 243 |
| 81d–e | 383n166 | III, 4.6.47–50 | 243, 243n36 |
| 90a | 25n32, 383n166 | III, 4.6.55–60 | 243, 243n37 |
| 90a–c | 34 | IV, 4.33 | 220 |
| 90b6–c2, 4–6 | 23, 23n24 | | |
| 90c | 19n7 | | |
| (Pseudo-)Plato | | Plutarch | |
| <i>Epinomis</i> | | <i>Moralia</i> | |
| 984d–e | 26n37 | <i>Amatorius</i> | |
| 984e | 61n75 | 756e–f | 344n19 |
| 984e3 | 220 | 764e | 348, 348n40 |
| <i>Epistle VII</i> | | 764f | 348, 348n41 |
| 344b7 | 22, 22n23 | 765a | 348, 348n42 |
| Platonic Scholia | | <i>De defectu oraculorum</i> | |
| <i>to the Greater Alcibiades</i> | | 414d–e | 20 |
| 1.122A | 161, 161n12 | 415a | 20 |
| Pliny the Elder | | 416c | 123n37 |
| <i>Natural History</i> | | 416c–d | 122n36 |
| II, 5.22–26 | 48, 48n7 | 416d | 337n100 |
| II, 55.143–44 | 294 | 416e | 21 |
| XXVIII, 17.63 | 380n51 | 416f | 20, 20n13, 21, 21n14, 21n15 |
| Plotinus | | 417a | 20 |
| <i>Enneads</i> | | 417a8–11 | 20n12 |
| II, 3 | 9n34, 238, 239n17, 268 | 417c | 123n39 |
| II, 3.9 | 244, 394 | <i>De facie quae in orbe lunae apparet</i> | |
| II, 3.9.1–14 | 239 | 926f–927a | 344–45n25 |
| II, 3.9.7–8 | 240, 240n25 | 929e | 26n35 |
| II, 3.9.10–11 | 240, 240n21 | 936f | 26n35 |
| II, 3.9.46–47 | 239, 239n20 | 938e | 26n35 |
| II, 3.10.4 | 240, 240n22 | 943a9–11 | 26, 26n40 |
| II, 3.15.1–5 | 239 | 943d9–10 | 26, 26n36 |
| III, 1 | 239n17 | 943e10 | 26, 26n36 |
| III, 4 | 9n34, 239, 242 | 944c | 21 |
| | | 944c–d | 305n9 |
| | | 944c–e | 26 |
| | | 945c12–945d4 | 27, 27n41 |
| | | <i>De fortuna Romanorum</i> | |
| | | 317f–318d | 50n17 |

- Plutarch (cont.)
- Generation of the Soul in Timaeus*
- 1014b 21n14
- De genio Socratis*
- 580d 22, 22n20
- 589c3-4 17, 17n1
- 590b-c 383n166
- 591b 25, 27n41
- 591b-c 21
- 591d1-3 24, 24n31
- 591d-e 24
- 591d-592c 382
- 591e 25, 25n32, 383n165
- 591f 25, 41n89
- 592c 25, 34
- 594a 25, 34
- De Iside et Osiride*
- 360d-e 241n28
- 360e 194, 194n1
- 361a 155n188
- 361b 123n39
- 361f-362d 78n3
- 362 78n2
- 369e-379c 162
- 378c6 104n129
- Platonic Questions*
- 1007c-e 21n14
- 1007c 44n98
- De sera numinis vindicta*
- 550a 44n99
- De superstitione*
- 168c10-11 19, 19n6
- Parallel Lives*
- Life of Marius*
- 46.1 59n62
- (Pseudo-)Plutarch**
- De fato*
- 568b-d 37n75
- 568d 29, 91n62
- 568e 30
- 568e2-5 29, 29n50
- 569a 30, 30n53
- 569a2-5 29, 29n52
- 569b-c 30
- 570b-d 30
- 571b 37n75
- 571d 37n75
- 572f-573a 31, 31n57
- 574b1-6 32, 32n59
- 574b6-8, 9-11, c1-3 33, 33n60
- Placita*
- 881e 123, 123n41
- 882b 124, 124n42
- Porphyry**
- On Abstinence from Killing Animals*
- 11, 37.4-5 122, 122n35
- 11, 38.4 142, 142n141, 212n72, 237n7
- 11, 39.3 237n7
- 11, 40.1-4 237n7
- On the Cave of the Nymphs in the Odyssey*
- 20-21 182n105
- 21-24 170
- 24 182n106, 183n107, 188, 188n127
- 29 159, 159n1, 192, 192n134
- 32.26-27 274, 274n147
- To Gaurus on How Embryos are Ensouled*
- 10.4.1-4 270n132
- 10.4-6 269n130
- 10.4-11.2 270n132
- 16.5.1-5 270, 270n133
- Introduction to the Tetrabiblos*
- CCAG V/4, 185-228 236n2
- CCAG V/4, 190.9-10 267n122
- CCAG V/4, 197.11-22 256n86
- CCAG V/4, 206.3-8 269
- CCAG V/4, 206.4-5 258, 258n94
- CCAG V/4, 206.21-24 271, 271n135
- CCAG V/4, 207.1-3 272n141
- CCAG V/4, 207.16-18 273, 273n143
- CCAG V/4, 207.23-27 272, 272n137
- CCAG V/4, 208.1-2 271, 271n136
- CCAG V/4, 208.4-5 272, 272n139
- CCAG V/4, 209.19-21 65n90
- Ch. 30 251n61, 270-71, 439-41, 442-45
- Ch. 30.1, 255n80
- CCAG V/4, 206.3
- Ch. 47 (Demophilus) 226n146, 227n147
- Letter to Anebo*
- 2.1a 247
- 2.2.a-f 247

2.2.g	247, 247n50	Ch. 8.4	133, 133n97
2.3b	247	Ch. 18	133, 222
2.12b	153, 153n79, 224, 224n138		
2.13a	274, 274n149	Ptolemy, Claudius	
2, 14–17	9n36	<i>Tetrabiblos</i>	
2.14a–d	236	I, 10	399n2
2.14b	249, 249n57	I, 12	142n143
2.14c	246	I, 14	142n143
2.14d	274, 274n150	I, 17	142n143, 186, 190
2.15a–c	267n122	I, 18.3	179n88
2.15a–b	236	I, 19	142n143
2.15c	246, 248n54	I, 23	223n133
<i>Life of Plotinus</i>		II, 8.2–4	259
10.14–33	239n15	III, 3	260
<i>De regressu animae</i>		III, 3.3	260, 260n98
27.21–28.15	274.148	III, 4.4	302, 302n77, 329, 329n76
<i>On What is Up to Us</i>		III, 9	288n28
Section 42 Wachsmuth	210n67	III, 10	288n28
268F–271F Smith	285n21	III, 11	227, 260
268F Smith	255n79, 258n90	III, 11.2	260, 260n99
271F Smith	240n26, 285n22	III, 11.3	154, 154n183
		III, 11.4	147, 147n154
		III, 11.5	108n149, 330, 330n77
Posidonius		III, 11.9.7	434n13
<i>Fragments (in Placita ap. Galen)</i>		III, 11.563–75	66n97
Fr. 417.4–11 (Theiler),		III, 15.3, 5, 6	140n133
Fr. 187.4–11		IV, 2	452n3
(Edelstein/Kidd)	124, 124n43	IV, 6.383–87	66, 66n100
		IV, 7.435, 476, 502	203n36
		IV, 10.20	323n65
<i>The Potter's Oracle</i>		Rhetorius	
P. Oxy. 2332		<i>Compendium</i>	
49–52, 58–62	84, 84n34	Ch. 54,	279n5, 338n101
col. 11, 60	84n33	5th consideration	
P. Rainer G. 19 813		Ch. 57	146n148
col. 11, 36	84n33	CCAG VII, 194–213	226n1144, 146
		(Teucer)	
Proclus		CCAG VIII/1, 239–41	265n117
<i>On Alcibiades I</i>		CCAG VIII/1, 240	265n118
78.1–6	246, 246n48	CCAG VIII/1, 240.8–28	433
<i>Commentary on Plato's Republic</i>		CCAG VIII/1, 240.12	324n67
11, 299.25–28 Kröll	286, 286n23	CCAG VIII/1, 241.9–10	265n119
		CCAG VIII/1, 239–40	265n120
Pseudepigrapha		CCAG VIII/1, 239.16	265, 265n121
<i>Hygromanteia of Solomon</i>	134n108	CCAG VIII/4, 118–24	232n167
CCAG VIII/2, 157.8–19	422		
<i>Testament of Solomon</i>			
Ch. 8.2	133, 133n99		
Ch. 8.3	134, 134n102		

Rhetorius (cont.)

- CCAG VIII/4, 120.27–123.6 450–54
 CCAG VIII/4, 120.27–28 309n23
 CCAG VIII/4, 121.3–11 49n13
 CCAG VIII/4, 121.7–11 330, 330n79
 CCAG VIII/4, 122.9–10 435
 CCAG VIII/4, 122.20–23 306, 306n14
 CCAG VIII/4, 122.22–23 321, 321n59
 CCAG VIII/4, 124.14–17 232n168
 CCAG VIII/4, 124.20 68n109
 CCAG VIII/4, 124.22 324n67
 CCAG VIII/4, 126–31 145
 CCAG VIII/4, 126 293n50
 CCAG VIII/4, 126.15–127.5 150n165
 CCAG VIII/4, 126.16–17 145n144
 CCAG VIII/4, 127.2–5 151, 151n169
 CCAG VIII/4, 127.17–19 127, 127n57
 CCAG VIII/4, 127.21–23 149, 149n159
 CCAG VIII/4, 130.5–8 146, 146n150
 CCAG VIII/4, 130.11–13 148, 148n155
 CCAG VIII/4, 130.14–20 148, 148n157
 CCAG VIII/4, 131.17–132.2 151, 151n170
 CCAG VIII/4, 144 293n50
 CCAG VIII/4, 144.17 145n144
 CCAG VIII/4, 148.26–149.1 310n29
 CCAG VIII/4, 151.12–13 149, 149n161
 CCAG VIII/4, 152.24–27 75, 75n135
 CCAG VIII/4, 154–57 145
 CCAG VIII/4, 154 293n50
 CCAG VIII/4, 154.10–12 60n66
 CCAG VIII/4, 154.19 145n144
 CCAG VIII/4, 155.21–22 149, 149n160
 CCAG VIII/4, 163 293n50
 CCAG VIII/4, 163.20 145n144
 CCAG VIII/4, 170.19–21 76, 76n138
 CCAG VIII/4, 174.8–11 60n66
 CCAG VIII/4, 174.12–17 75, 75n136
 CCAG VIII/4, 204.15, 18, 21 324n67
 CCAG VIII/4, 207.20–21 427
 CCAG VIII/4, 221.1–224.20 436
 CCAG VIII/4, 222.9–10 435
 Par. gr. 2425 436
- Sarapis 'aretalogy'**
 P. Berlin 10525 106n142,
 202n36
- Serapion (astrologer)**
 CCAG VIII/4, 227.1–5 154n185
- CCAG VIII/4, 227.17 308, 308n20
 CCAG VIII/4, 227.19 153n178
 CCAG VIII/4, 227.19–21 154–55, 155n186
 CCAG VIII/4, 227.24 155, 155n187
 CCAG VIII/4, 228.1–16 331n83
 CCAG VIII/4, 228.12–15 271n134
 CCAG VIII/4, 229.1–3 263n112
 CCAG VIII/4, 231.26–28 76n138
- Shakespeare, William**
Richard III
 1.3.143–144 116, 116n1
- Sophocles**
Ajax
 l. 485 382
- Strabo**
Geography
 17, 1, 17 78n3
- Suidas**
Lexicon
 I, 439, 4695 462n3
- Syncellus, Georgius**
Ecloga Chronographica
 24 139n28
- Synesius**
Aegyptius, sive De Providentia
 I, 10, 99d–100a 125–26, 126n49
- Tacitus**
Histories
 4, 83–84 78n3
- Teucer of Babylon** 226n144, 146,
 227n148
- Thrasyllus**
Summary of the Tablet of Thrasyllus to Hierocles
 CCAG VIII/3, 100 143
 CCAG VIII/3, 100.27–30 185, 185n117
 CCAG VIII/3, 101.18–19, 22–23, 28–29 64, 64n86
 CCAG VIII/3, 101.23 61n72
 CCAG VIII/3, 101.23–25 140–41, 141n136
 CCAG VIII/3, 101.26 64n86

Vettius Valens*Anthology*

I, 1.1	21, 21n17, 22n22, 25, 25n33, 305, 305n12, 306, 306n14	II, 18.7–8	317–18, 318n54
I, 1.1–2, 5, 47	22, 22n21	II, 19	193, 446, 452n1
I, 1.2, 5	205n44	II, 20–22	9n31
I, 1.47	177	II, 20	306, 306n14
I, 1.4	25–26, 26n34, 27n42, 245n43	II, 20.1	27n44, 65, 65n93
I, 1.7	245, 245n41	II, 21	8n27
I, 1.14	140n133	II, 21.1	52, 68, 68n109
I, 1.15	245, 245n42	II, 22	193
I, 1.21	245n44	II, 22.2–9	318n55
I, 2	402n13	II, 22.17–29	318n55
I, 2.1, 14, 35, 51, 57	185n18	II, 22.26–29	319, 319n56
I, 2.14	68, 68n110	II, 22.36–37	318n55
I, 9.3–5	169n48	II, 22.38–39	318n55
I, 16.4	413n31	II, 22.40–42	318n55
II, 1	402n13	II, 23	446
II, 3	446	II, 23.7	309, 309n26
II, 3.1	334n92	II, 27.1–2	329, 329n74
II, 5	146n148	II, 32	407n18
II, 5–16	401n10	II, 37	313, 412
II, 5.1	223n134	II, 37.1–5	468–69
II, 5.1–3	143	II, 37.5	313, 313n39
II, 6.1	223n134	II, 37.20–25	469
II, 6.3	67, 67n104	II, 41	260
II, 10	223n134	II, 41.3–4	260–61, 261n102
II, 10.2, 3, 4	224n134	II, 41.5–20	261n103
II, 11	142n140, 146n148	II, 41.9	261, 261n104
II, 11.1–2	143	III, 1	107, 265n118, 266
II, 12.1–8	67n106	III, 1.1	258n90
II, 12.2	223n134	III, 2	400n6
II, 12.9	67n104	III, 3	265n118
II, 13.1	7n25, 34, 308n20	III, 5	265n118, 407n18
II, 14.1	223n134	III, 7.1–15	261n106
II, 15.9	7n25, 308n20	III, 7.13	434n13
II, 16	67, 143	III, 11	107
II, 16.1	356, 356n90, 400n8	III, 11.3–5	332, 333
II, 17–18	9n31	III, 11.3	287n25
II, 17.32–33	68–69, 69n111	III, 11.7	333n89
II, 18, 20, 21	317	III, 11.12	287n26, 332, 332n84
II, 18.5	317n52	III, 13	411
II, 18.6	321, 321n58, 393	IV, 4	287n26, 306, 306n14
		IV, 4–10	9n31
		IV, 4.2	27n42, 305, 305n11, 13
		IV, 4.3	200n28

Vettius Valens (cont.)

IV, 4.5-6	332
IV, 4.7	316n50
IV, 6	411
IV, 8.1-23	322n62
IV, 11	9n31
IV, 11.4-9	347n37
IV, 11.6	323, 323n64
IV, 11.7	36, 36n72, 37
IV, 11.11	36, 36n73, 37
IV, 11.32	9, 9n33
IV, 11.48	143
IV, 11.49	357, 357n91, 388n181
IV, 11.54	302n75
IV, 12.1	143
IV, 12.2	140, 140n134
IV, 13	193n139
IV, 15.1-2	39, 39n84
IV, 25	9n31, 306, 306n14, 446
IV, 25.1-4	324, 324n68, 327
IV, 25.5-12	357-58, 358n94
IV, 25.13	364, 364n109
IV, 25.14-15	358, 358n95
V, 2	40
V, 2.22, 23	41, 41n88
V, 6.2	40n85
V, 6.4	37nn75, 77,
V, 6.9	38,
V, 6.10	40n85
V, 6.16	44, 44n97
V, 6.20	40n85
V, 6.119-25	319-20, 320n57
V, 6. 121-25	325-26, 326n72
V, 8.112	38
VI, 1.7	34n70
VI, 1.15-16	38, 38n82
VII, 2	262, 266
VII, 2.2	262, 262nn107, 108
VII, 2.2-15	262

VII, 2.23	224n134
VII, 6	287n26
VII, 6.127-60	244
VII, 6.127	245, 245n45
VII, 6.231	37
VIII, 7 and 8	304n5
IX, 1.10	36-38, 37n74, 38n78, 43
IX, 1.11	43, 43n95
IX, 1.12	26, 26n38
IX, 1.12-15	355, 355n88
IX, 1.16	43, 43n96
IX, 2.1-8	333
IX, 2.5	287n26, 332, 332n87
IX, 2.5, 7	310n28
IX, 2.7	333, 333n92
IX, 2.7-8	287n26
IX, 2.8	334n92
IX, 2.14	427
IX, 3	68
IX, 3.5	400n5
IX, 3.6-18	143
IX, 3.7	68, 68n108
IX, 12.2	43, 43n94
IX, 12.19	37n77, 39-40, 40nn85, 86
IX, 12.28-31	41-42, 42n91, 196n9
IX, 12.29	53n31
IX, 16.2	133n100

Xenophon

<i>Anabasis</i>	
7.8.1-6	52n23

Zosimus of Panopolis

Final Receipt

7	139, 139n129
---	--------------

On the Letter Omega

2.4	139n131
8	139n131

Selected Word Index

Greek, Latin, Egyptian and Coptic, Akkadian, Hebrew (includes occurrences of transliterated words)

Greek

ἀγάλλη 379

ἀγκάς 379

ἄγκος 379

αἴρεσις 146n151, 256n86, 262n107, 271n135,
326n72, 403, 407n20, 417, 430, 431n5,
440, 442, 450–51

ἀλάστωρ 122, 473

ἀναγκάζω 21n14, 49n12, 379

ἀνάγκη, ἀναγκαῖος 23n24, 36n73, 41n88,
42n91, 238, 240n25, 283n19, 332n87, 342,
342nn11–12, 345, 346n30, 347n38,
358n95, 379, 380n154, 381n158, 382,
382nn160, 162, 437

Ἀνάγκη 233, 274n149, 283n19, 299n66, 340,
342, 343n18, 345nn26–27, 30, 347nn35,
38, 349, 350n48, 354n76, 359n96,
380n153, 457

ἀπορροία 21n16, 43, 43n95, 147n154, 205n42,
263n12, 305n11, 332n87, 333n92, 479

ἀποτελεσμα, ἀποτελεσματικά 35n71, 37n75,
42n91, 66n99, 102n118, 229, 232n168,
236n2, 252n67, 272n139, 302n75, 313n36,
331, 347, 425, 444, 448, 452, 456, 461,
465, 467, 469

ἀποτελέω 39n84, 68n106, 75n136, 140n134,
245n42, 305n11, 324n68, 418, 447, 456,
469

Ἄτροπος 27n41, 283n19

ἀφαιρετικός 152, 153

γένεσις 26n34, 40, 27n41, 65n90, 155n186,
182n106, 185n117, 188n126, 200n26,
201n32, 202n33, 204, 210n64, 230n160,
232n168, 242n29, 245n43, 249n56, 255,
261n102, 262n107, 263, 264n113,
268–269, 272n137, 274n150, 286n23,
319n56, 320n57, 323n65, 326n72,
330n79, 332n87, 340, 341n6, 343n18,
359n98, 417–18, 429, 432–33, 439–40,
442–44, 450, 452, 455, 458, 468–69, 479

(τὸ) δαιμόνιον 17n1, 18n3, 21, 21nn14, 18, 22,
24n28, 33–34, 33n60, 36–37, 36n72,
39–42, 40n85, 42nn91–92, 57n53,
128n67, 130, 137–40, 139nn129–131,
206

δαιμονιώδης 65, 152, 153–54

δαισινδαιμονία 19, 20n9

δεκανός, δεκανικῆς 220, 224n138, 225n139,
227n148, 229nn156, 158, 230n160,
232b168, 235n183, 249n57, 452, 478,

διακονέω, διακονικός 20n13, 21

διαπορθμεύω 20n13

(τὸ) δυνατόν 37n75, 41n88

δυσδαίμων 20n9

ἐβδομάς 169n45

εἶδος 213, 244n38, 250n59, 253n72, 357,
358n94, 382n161, 432, 478–79

εἰμαρμένη 28–32, 29nn50, 52, 30–33, 31n57,
32n59, 33n60, 37–43, 37n75, 40n86,
42n92, 45, 90–91, 90n55, 91nn60, 62,
103–04, 112, 123n38, 179, 181, 201n32,
202–03, 202n33, 203n36, 211–13, 212n73,
221, 238, 243–45, 243n37, 245n45,
246n48, 248n52, 266n122, 274–75,
274nn149–150, 275n150, 349, 381nn158–
159, 382, 162, 391, 412, 420

ἐκλείπω 20

ἐμπρόσθια 152, 153

ἐνέργεια 29, 37n75, 103, 123n38, 209, 212n73,
213, 221, 228, 233, 252n68, 300n70,
302n75, 422

ἐρινύς 122, 122n34, 233, 345n30

ἐρμηνεύω, ἐρμηνευτικός 20n13, 21n15, 24n27

ἔρωσ 123n38, 212n73, 233, 343n17, 345n25,
348, 350n48, 352n67, 472

εὐδαιμονία, εὐδαίμων 9, 20, 23, 34, 58–59,
68n106, 75n136, 112, 124n43, 274, 317,
347, 417, 450

ἐφ' ἡμῖν 32n59, 37n75, 240n26, 250n59,
255n79, 274n149, 285nn21–22, 298n64,
458

- ζῶδιον, ζῶδιακός 68n106, 74n131, 75n136,
146n150–151, 148n157, 154n185, 155n185,
183n107, 221n121, 224n138, 232n168,
249n57, 252n68, 272n141, 332n87,
358n94, 400n6, 405n17, 413n36, 417, 423,
430, 432–33, 436, 443, 448, 450–51, 469,
478
- θεά 70, 70n15, 356n90, 357n91, 400, 472–73
- θείος 23n24, 29n52, 38n82, 43n95, 187n125,
188n126, 253n72, 31n32, 348n41,
350n50, 355n88, 448, 456–57
- θεός 19n6, 20n12, 21n18, 31n57, 37n74, 39n84,
40n85, 41n88, 43n94, 44n97, 99, 70,
88n147–48, 101n15, 123n41, 124n42,
126n49, 133n97, 159n1, 188n126, 192n134,
193n138, 200n25, 202n34, 206n49,
211n69–70, 220n16, 221n24, 224n138,
229, 233n171, 239n20, 248n52, 253n72,
274n147, 149, 281n16, 283n19, 286n23,
31n32, 342n9, 343n17, 345n26, 347n36,
356n90, 357n91, 360n103, 380n153, 401,
448, 457, 472
- θεραπεύω 23n24, 249n56, 274n149
- ἰδιοπροσωπέω 67n106, 224n134
- ἴδιος δαίμων 196n11, 197n12, 236, 249n56
- καιρός, καιρικός 9n33, 40–41, 41n88, 43,
44, 139n132, 233n171, 247–48, 248n52,
412
- κακοδαίμων, κακοδαιμονία, κακοδαιμονέω
20n9, 112, 124, 145n144, 146n150,
148n157–158, 151n167, 170, 448
- καλή ὥρα 41, 42n91, 53n31, 196n9
- καταρχή 40–42, 41n88, 42n91, 66–67,
113n183, 139, 195, 258n91, 360, 360n103,
366, 367n117, 392, 436–38
- κλήρος 40n85, 75n135, 280, 283n19, 284, 286,
291, 296n61, 297, 298n65, 300, 302n77,
309n22, 329n76, 377n144, 378, 447–48,
450–52, 455–58, 480–82
- κλήρος τῆς ἀνάγκης 9n33, 297, 299n66,
341n6, 356n90, 357n91, 372, 359n96,
360n103, 367n117, 447, 455–58,
477–79
- κλήρος τῆς βάσεως 309n23, 26, 310n30, 447,
450
- κλήρος τοῦ δαίμονος 7n25, 8n28, 9n33,
149n161, 286, 288n29, 297, 298n65,
308n21, 309n22–23, 31n32–33, 319n56,
320n57, 324n68, 326n72, 329n74, 330n79,
332n84, 333n90, 356n90, 357n91,
360n103, 364n109, 367n117, 447–48,
450–51, 455–58, 468–69, 477–80
- κλήρος τοῦ ἔρωτος 9n33, 297, 356n90,
357n91, 358n94, 359n96, 98, 360n103,
364n109, 367n117, 447, 455–56, 458,
477–78, 480
- κλήρος τῆς τύχης 7n25, 8n28, 9n33, 67n106,
68n106, 149n161, 286, 297, 298n65,
308n20, 309n22–23, 318n54, 319n56,
320n57, 321n58, 324n68, 326n72,
329n74, 330n77, 79, 331n81, 332n84,
87, 333n88, 90–91, 334n92, 356n90,
357n91, 360n103, 364n109, 367n117,
432–33, 437, 438n17, 447–48, 450–51,
455–58, 468–69, 477–80
- Κλωθώ 27n41, 134n102, 283n19
- κοσμοκράτωρ 133
- κραταίος 65, 152, 153
- κυβερνήτης 269, 270n132, 343n18, 439, 442
- κύριος, κυριεύω 27n44, 67n106, 68n106,
75n135, 127n57, 134n108, 148n158,
201n32, 255n81, 256n86, 257n90,
258n90, 260n99, 261n104, 263n112,
268–69, 271–72, 272n137, 141, 273,
299n66, 305n11, 31n33, 319n56, 320n57,
326n72, 329n74, 330n79, 332n84, 422,
435, 437, 439, 442–44, 448, 450–52, 455,
457, 469 (see also dominus)
- Λάχαισις 27n41, 283n19
- λειτουργός 20n12, 219, 227, 249n57, 251n63
- μετακόσμιος 145
- μοῖρα 29n50, 66n99, 126n49, 154n185,
155n185, 187n125, 188n126, 242n29,
253n72, 263n112, 283n19, 284, 331n82,
332n87, 377n144, 400, 412–14, 413n31,
35–37, 414n38, 424, 426, 429–30,
436–37, 477, 480–81
- Μοῖραι 27n41, 203n36, 205n42, 233n171,
345n30, 347n38
- μοιρικός, μοιρικῶς 155n185, 332n87, 405n17,
430

- ναύκληρος 269, 439, 442
 νοητός, (δια)νοητικός 38n82, 21n70,
 244n38, 320n57, 326n72, 348,
 382nn161–162
 νόμος 29, 40n86, 49n12, 67n106, 103, 109,
 420
 νοῦς 22, 24–27, 25n32, 26n40, 34, 37n76,
 41, 42n91, 45, 123, 162, 211, 218, 250n59,
 269, 305n12–13, 313n39, 337, 350,
 381n158, 390–92, 468
- οἰκοδεσπότης, οἰκοδεσποτέω 12, 68n106,
 75n135, 107, 149n161, 236–37, 246,
 248–51, 249n57, 250n59, 251, 253,
 255–66, 255nn80–81, 256, 256n82, 257,
 258, 260n98, 261nn102, 106, 262n107,
 263, 264, 265–66, 267n122, 268–72,
 272n141, 423–32, 435–40, 442–44,
 448–49, 452, 454, 469, 479
- οἶκος 188n126, 229n156 (οἰκητήριον),
 256nn83, 86, 260n98, 326n72, 423, 426,
 430, 432, 443, 451, 473, 477–78
- οἰκείος δαίμων 25, 236, 238, 242n29, 250n58,
 264n116 (*see also* ἴδιος δαίμων)
- ὀπίσθια 152, 153
- πάθος, παθητικός 8n28, 9n33, 239, 240,
 240n25, 246n48, 356n90, 358n94, 447,
 451, 468–69
- Παντόμορφος 221
- παράδειγμα 282, 283n19
- παρاناτέλλων 173, 224n138, 226, 229n157,
 232n168, 452
- πίναξ 208, 209, 235n183, 309
- πλανάω, πλάνης 29n50, 35n73, 41n88,
 123n38, 134n102, 193n138, 197n12, 211n70,
 212n73, 213, 224n138, 233n171, 332n87,
 347n38, 422, 448
- πνεῦμα, πνευματικός 43n95, 133, 137n117, 142,
 204n42, 305n11, 310n30, 326n72, 332n87,
 447, 455, 472
- πράγμα 22n20, 65n92, 200, 201n32, 208n58,
 324n68, 358n94, 359n96, 360n103, 418,
 447, 450–51, 455–57
- πράξις 8n28, 27n44, 31n57, 41n88, 42n91,
 76n137, 261n102, 305n13, 321n59,
 324n68, 325n70, 326n72, 356n90, 418,
 443, 447, 450–51, 455, 469
- προαίρεσις 37n75, 42n91, 298n64,
 324n68, 359n95, 359n96, 447,
 455, 457
- πρόνοια 22, 30, 31n57, 32, 33–34, 33n60,
 36–40, 36nn72–73, 37nn74, 76,
 39n84, 42–45, 44nn98, 100, 91n61,
 177, 246n48, 306, 345n25, 349,
 352n61, 357, 358n94, 381n159, 382,
 382nn159, 160, 162, 391
- προσθετικός 152, 153
- προφήτης 282, 283n19
- σημείον 21, 22n18, 452
- στοιχείον 133, 134n105, 242n29, 249n57,
 250n58, 253n69
- συμπάθεια 272n137, 273, 332n87, 333n92,
 359n98
- σύνδεσμος 355, 379n148
- συνοικοδεσπότης 256, 258, 272n141, 428, 433,
 440, 442–43
- σχῆμα, σχηματίζω 44n98, 68n106, 69n111,
 127n56, 146n151, 213, 262n107, 272n137,
 274n150, 318n54, 354n80, 359n95, 433,
 443–44, 448, 450–52
- σώμα, σωματικά, σωματικῶς 8n28, 21n16,
 26nn34, 40, 27n44, 40n85, 123n38,
 124n42, 205n42, 212n73,
 220n116, 221n121, 242nn29, 33,
 245n43, 246n48, 250nn58–59,
 261n102, 298n64, 305n11, 309n22,
 310n30, 318n54, 355n88, 358n94,
 382n161–162, 447, 451, 455, 457–58,
 468, 479, 481–82
- τριάκοντα ἕξ (λς') 221nn121, 124, 233n171
- ὔλη 20, 44n98, 125, 126n49, 248n52
- φρόνησις 22–23, 22nn20, 22–23, 23n24,
 27n44, 298n64, 305n12, 337, 356, 378,
 392, 455, 457, 482
- φύλαξ 31n57, 142n141, 221n122, 283n19
- φύσις, φυσικός 20n13, 21n15, 25, 29n51,
 68n106, 110, 124n43, 126, 140n134,
 147n154, 148n157, 151n167, 165, 197n12,
 209n62, 243n36, 245n45, 246n48,
 249nn56–57, 252n67, 305n13, 345n25,
 354n76, 358n94

χρηστήριον 20

ψυχή, ψυχικός 8n28, 26nn38, 40, 27n44,
29n50, 38n82, 43n96, 64n86, 123n38,
124nn42–43, 126n49, 139n129, 142n141,
148n157, 210n64, 212n73, 230n160,
240n21, 242n29, 244n38, 250n59,
270n133, 283n19, 298n64, 305nn12–13,
309n22, 321n59, 324n68, 350nn48, 50,
355n88, 447, 451, 455, 457, 468

ῥορα 41, 42n91, 53n31, 68n106, 148n158,
151n167, 169n48, 196n9, 197n12, 200n25,
265n121, 332n87, 423, 430, 455 (*see also*
καλή ῥορα)

ῥορονόμος 227, 437, 452

ῥοροσκόπος 39n84, 42n91, 64n86, 65nn90, 92,
66n99, 67n106, 68n106, 145n144,
149n161, 151n167, 188n126, 202n34,
210n67, 211n68, 224n138, 225n139, 227,
229n158, 230nn159–160, 271n135,
309n26, 310, 317, 319n56, 321n58,
326n72, 329n74, 330n77, 332nn84, 87,
333n92, 334n92, 356n90, 357n91,
360n103, 364n109, 377n144, 395, 400,
417–18, 429–30, 432–33, 437–40,
442–43, 447, 450–52, 455–56, 479–81

Latin

almuten thematis 272

Basis 288–89, 288n31

Cupido 288, 288n31, 349, 359n99, 360n101,
361n05, 362, 363

(*pars, locus*) *Daemon* 363nn107, 108, 466

daemonium 130

dator vitae 107

decanus 225n140, 231n166, 232nn166, 168

deus, dea 48n7, 70n115, 60n69, 187, 190,
192–93, 341n6, 416, 465

dominus 312n35, 460, 463–65

dominus geniturae 262–63, 262n109, 263nn110

figurare, figura 56n47, 127n56, 213, 213,
223n130, 341n6, 360n101 (*configuro*)

genius 22, 70, 83, 94–95, 95n84, 111n71,
141n138, 288n31, 295n56

liturgus 228, 251n63

munifex 228

necessitas 147n152, 361n105, 363, 363n108

Necessitas 288–89, 288n31, 341n6,
362–63

Nemesis 288

numen 61, 106, 228–29, 416, 465

Omniformis 221n127

pars 7n24, 56, 70n117, 71, 127n56, 291, 293,
312n35, 313n41, 341n6, 345n30, 359n99,
360n101, 363nn106–107, 365n110,
413n35, 415, 461–66

sors 48, 56, 57n50, 58, 291, 291nn40, 43,
292n45, 293, 300, 363n107, 415–16

species 213, 341n6

templum 56–57, 56n49, 57n50–51

Egyptian

ḥ.wy (house, place) 54n34, 55, 57n51,
141

ḥš-šḥn (matter) 208n58

šḥ.w, šḥ, ḥḥy (spirit) 218

wpwḥy.w (messengers) 121, 215

wry, Wry.t (bad fortune, deity of bad fortune)
53, n34, 141, 141n138

wry.t (name of the 6th place) 53, 141

bšk (servant) 219

ntr, ntr (god, divinity) 57, 77n1, 88n49,
97, 97n91, 98nn91–92, 118, 121, 206,
215n83, 315

rnn.t, rnnwtt (Renenet, Renenwetet) 90,
96n87, 100

hby.w (emissaries) 121, 215

ḥšty.w (fighters, slaughterers) 121, 215, 217

šḥn, šḥny (outcome) 53, 91n60, 102

sšr (slaughtering demon, evil spirit, name of
the 12th place) 54

šši (order, decree, determine) 103–09,
104n127, 106

ššy, šy (Shai) 88n49, 96n87, 100n106, 206,
316n49

ššy, šy (fate) 53, 77n1, 89–90, 91n60, 99,
102n118, 104–05, 109, 110, 114

ššw (fate, destiny) 90n55, 104–05, 109,
216

šy (name of the 11th place, Shai) 53–56,
55n43, 315

špšy.t (wealth, fortune, Shepset) 53, 61,
88n49, 89, 102n118, 141

špšy (name of the 5th place, Shepshy)

53–55, 55n43, 61

šmžy.w (wanderers) 121, 215, 217

šsr.w (arrows) 215, 215nn85–86, 219

tny.t (lot, part) 141, 304n7

Coptic

ⲁⲢⲭⲔⲬⲚ 180n92

ⲁⲗⲓⲛⲟⲙⲓⲟⲛ 180–81, 180n96, 181n97, 251n64

ⲁⲉⲕⲁⲛⲟⲥ 180–81, 180n96, 181nn98–99, 251n64

ⲉⲃⲁⲟⲛⲁⲥ 169n43

ⲉⲗⲟϢⲓⲁ 180, 251n64

ⲗⲓⲧⲟϢⲣⲟⲥ, ⲗⲉⲓⲧⲟϢⲣⲟⲥ 180–81, 180n96,
181n98, 251n64

ⲛⲟϢⲧⲉ 180, 251n64

ⲭⲟⲉⲓⲥ 180, 251n64

Akkadian

ilu (god, deity) 111, 118

išturu (deity, spirit) 111

lamassu (spirit) 111, 117, 172, 392

lilû ('demon') 117, 119

šimtu ('fate') 108–11, 109n154, 391

šēdu (spirit) 111, 128, 171,

Hebrew

אֱלִילִים (*'lîlîm*) 129

גֹּד (*gd*) 129

דָּבַר (*dbr*) 127–28

מִנִּי (*mnî*) 129

קִטְבַּ (qtb) 127, 130

רוּחַ (*ruh*) 133

רֶשֶׁף (*ršf*) 128

שְׂדִים (*šdîm*) 128–29, 128nn66, 68