

THE

SURVIVAL NURSE



Running an
Emergency
Nursing Station
Under Adverse
Conditions

Ragnar Benson

THE SURVIVAL NURSE



Running an
Emergency
Nursing Station
Under Adverse
Conditions

Ragnar Benson

PALADIN PRESS • BOULDER, COLORADO

Also by Ragnar Benson:

Acquiring New ID
Do-It-Yourself Medicine
Eating Cheap
Guerrilla Gunsmithing
Live Off the Land in the City and Country
Mantrapping
Modern Survival Retreat
Modern Weapons Caching
Ragnar's Action Encyclopedias, Volumes 1 and 2
Ragnar's Guide to Interviews, Investigations, and Interrogations
Ragnar's Guide to the Underground Economy
Ragnar's Ten Best Traps . . . And a Few Others That Are Damn Good, Too
Ragnar's Urban Survival
Survival Poaching
Survivalist's Medicine Chest
The Survival Retreat: A Total Plan for Retreat Defense
Switchblade: The Ace of Blades

The Survival Nurse:

Running an Emergency Nursing Station Under Adverse Conditions

by Ragnar Benson

Copyright © 2000 by Ragnar Benson

ISBN 1-58160-075-5

Printed in the United States of America

Published by Paladin Press, a division of
Paladin Enterprises, Inc.,
Gunbarrel Tech Center
7077 Winchester Circle
Boulder, Colorado 80301 USA
+1.303.443.7250

Direct inquiries and/or orders to the above address.

PALADIN, PALADIN PRESS, and the "horse head" design
are trademarks belonging to Paladin Enterprises and
registered in United States Patent and Trademark Office.

All rights reserved. Except for use in a review, no
portion of this book may be reproduced in any form
without the express written permission of the publisher.

Neither the author nor the publisher assumes
any responsibility for the use or misuse of
information contained in this book.

Visit our Web site at www.paladin-press.com

Contents

Introduction	1
<i>Chapter 1: Shelter</i>	5
<i>Chapter 2: Water</i>	15
<i>Chapter 3: Food</i>	27
<i>Chapter 4: External Energy</i>	51
<i>Chapter 5: Laundry</i>	75
<i>Chapter 6: Supplies</i>	85
<i>Chapter 7: An Antiseptic Attitude</i>	103
<i>Chapter 8: Doctor's Orders</i>	115
<i>Chapter 9: Sewing Patients Back Together</i>	121
<i>Chapter 10: Pulling Teeth</i>	127
<i>Chapter 11: Midwifery</i>	135
<i>Chapter 12: Physical Therapy</i>	143
Conclusion	149

Preface



nursing as a profession is relatively recent. Famous examples of professional nurses include Florence Nightingale, the English lady who distinguished herself during the Crimean War (1854–1856), and American Civil War nurses Kate Cumming and Mary B. Chesnut (1861–1865). Amid severe opposition bordering on pathological, women like these selflessly came forward to help alleviate the suffering of men wounded in battle.

In reality, nursing has been with us through the ages. For centuries, women have provided effective, long-term healing care for the sick, wounded, and maimed. It wasn't full-time professional care provided by trained, certified workers, but it was still nursing.

What we have seen in the last century is a formalization of a task traditionally carried out by one's family. Despite the relatively primitive levels of information and understanding of medical cause

and effect, these dear souls often did remarkably well at bringing their patients back to health.

Why, when women were the traditional long-term caregivers of choice, was society so reluctant to admit them to the business on a professional basis? Cumming and Nightingale both reported heavy, often irrational, opposition to their work. Commonly this opposition took on sexual overtones. Strange, because these women were not interested in fame, pay, or finding a husband but only in alleviating pain and suffering. Often their work was done at great personal cost to themselves.

I have concluded that opposition to female nursing was the direct result of the indescribable horrors of war. Kate Cumming wrote of her first reaction to an after-battle hospital. She was so overwhelmed by the mutilated but still living soldiers and the dirty, stinking conditions surrounding her patients that words simply failed her. "The horror of it all defied description," she wrote in her diary.

When she did attempt to describe the aftermath of battle, the results were horrifyingly graphic. Cumming reported, for instance, that after four days, Civil War battlefields were so fetid, foul, and fly-blown that no one could come within a mile of the area lest they be overcome by smells, insects, vultures, and seething, crawling, nauseating masses of human flesh.

Combat veterans agree. War is absolute, unmitigated hell. There is nothing to recommend it and nothing at all glorious about it.

Traditionally, men have marched off to war with the support of their mothers, sisters, wives, and lovers who remained behind. If the female half of the population had really understood the sheer agony, fear, and cruelty of this enterprise, they may never have given their approval. Perhaps subconsciously, men attempted to shield their wives, sisters, mothers, and lovers from something so horrible that *no one* should be a witness. This seems to be the underlying philosophical problem that kept women out of military hospitals till the mid-19th century.

Despite these early hurdles, women eventually earned the needed respect and subsequently their rightful place in the

PREFACE

VII

field of professional medical care. But is nursing inherently a female calling, as suggested by the domestic origins of the work? Demonstrably there are exceptions, as evidenced by the many really good men we see working as nurses today, and it is extremely helpful, even essential, to have males present to assist with the heavy lifting that always goes with nursing duties. But in reality, nursing is mostly a female calling. And the admittedly overt sexist conclusion I have been forced to recognize is that, as a group, women do it best.

It won't be a preoccupation, but it is an underlying theme of this book. Women are the only ones tough enough in spirit to withstand the heartbreak, tears, terror, and back-breaking work that nursing entails. This is especially true in a survival nursing context.

A NOTE ON SOURCES

This book would not have been possible without the assistance of many medical professionals. Because cooperating with an author who suggests that people can and should do for themselves carries great stigma in some circles, they are listed only by their first names.

Two full-fledged medical doctors stood by my side as this volume developed. These were my own consulting physicians: John (whom I affectionately refer to as more of a field physician than a clinical M.D.) and Bradford, the notable libertarian doctor-adventurer so delightful to befriend. There were many other doctors who answered fleeting questions relative to their specialization. They are not mentioned because they did not, as a rule, realize that they were advancing the writing of a book on survival nursing.

Of nurses themselves, there were many who wittingly or unwittingly assisted. Most now view me as a bottomless question pit. Most notable are Jackie, Betty, Dianne, Irene, and Jennie.

Lastly, many Civil War nurses left diaries for our instruction. These are often marvelous sources of information and insight, if readers have the stomach for the terrible carnage

SURVIVAL NURSING
VIII

seen through their eyes. As Dr. Bradford said, *everything* about our Civil War involved survival nursing.

So what, exactly, is survival nursing and how is it different than regular nursing? Read on.

Introduction



nursing is commonly defined as the temporary provision of longer term medical and physical assistance to those unable to care for themselves. Doctors patch up patients after a medical incident; nurses provide extended long-term care necessary for healing. In a survival context, nursing also involves responsibility for all of the dozens of activities necessary to support this restoration of health.

Survival nurses must provide all support functions without outside support or assistance. Dirty linens and clothes, for instance, must be laundered by survival nurses rather than sending them out for cleaning. Laundry in survival hospitals can involve the labors of one person for every 10 patients!

Food is another important example. Everything must be raised, scrounged, trapped, or otherwise procured and prepared by the harried care giver. Civil War nurses had several men per hospital wing whose only duty was to hunt, shoot, trap, or purchase edibles for their patients.

Daily workloads in true survival nursing situations are extremely heavy—no less than dawn-to-dark at hard labor. No holidays or weekends allowed. As patients begin to heal, they can assist with some of the more mundane chores such as snapping peas or boning meat. For this as well as for medical reasons, survival nurses in particular need to bring their charges round to self-sufficiency and a place where the patients can share some of the workload. It's good healing therapy, and it may be vital to survival of the entire enterprise. More on this in a later chapter.

In this regard, this volume departs slightly from a pure survival posture to one that is a bit more street practiced. In other words, more of an attempt is made to use time-saving devices such as washing machines and sewing machines, for instance, than in other survival situations. Without these machines, there would not be enough time in the day to get it all done, perhaps leading to the death of patients.

One hopes that all of this tough work will lead to patient recovery, but this happy conclusion is far from certain. Experienced nurses tend to develop a certain brusque crustiness that insulates them from the realities of their work. Many of their charges never do make a full recovery. During the Civil War, nurses considered it a real triumph if they sent a one-legged man home after amputation to lead life as a semihelpless invalid.

Frequently patients just die. Survival nurses become hardened to the fact that they have to dig lots of holes in the ground. Contemplation becomes a villainous enemy, especially in a war situation. Dwelling overlong on the question of why a fine young man was so horribly mutilated or why one is forced into incredibly harsh living conditions is not helpful but very common for those stuck with the dull job of washing the sheets over a washboard! Those down in the trenches easily see the folly of it all.

Not only must survival nurses do it all, their situation is made even more desperate by the fact that their charges are often given less than ideal initial treatment and that appropriate medications and supplies are often scarce or totally unavailable. But a frequently overlooked problem faced by

INTRODUCTION

survival nurses—and the very inspiration for this book—is that their activities are sometimes perceived as illegal in over-regulated or tyrannical societies. Overzealous bureaucrats and tinhorn dictators, for reasons ranging from the numbingly mundane to the murderously cruel, may consider it a crime for “unapproved” citizens to assist the sick and wounded.

Think about it. The paper-pushing bureaucrat may deny approval of the sale of medical supplies to someone not registered as a state-sanctioned medical caregiver, per regulation 124, subparagraph 47c, etc., etc., all while the patient in need of the supplies slowly dies for lack thereof. The dictator may deny medical assistance to a segment of the population he views as a threat, leaving thousands to a cruel fate.

Farfetched, you say? Well then, consider how the U.S. Food and Drug Administration (FDA) does not allow dying cancer or AIDS patients to pursue alternative treatments not approved by its army of bureaucrats. After all, the FDA reasons, these *already dying* patients may actually die if the treatment doesn't work. On the murderous side of the scale, the government of Ethiopia withheld food from starving Eritreans during that country's civil war in the 1980s, resulting in the deaths of thousands. Closer to home, the FBI shut off water and power to the Branch Davidians' property during the 51-day siege in 1993, forcing men, women, and children to live in their own filth in an effort to get them to capitulate to snipers, tanks, and helicopters waiting outside.

Like successful survivors everywhere, therefore, survival nurses will have to engage in some very deep hiding. This must be accomplished while still providing the necessities of a credible survival nursing program such as shelter, water, and sanitation. A tall order indeed.

When trying to determine how to begin this book, I asked three nurses, all with experience nursing under primitive conditions, which was most important: food, water, shelter, sanitation, or energy?

They are *all* essential, I was informed with enthusiasm. Survival nursing, they echoed, isn't practically possible if any

one of these elements is even only partially provided. In addition to the big five, there are dozens of peripheral matters such as securing and storing drugs, disinfectants, cleaning supplies, sickroom linens, bandages, dressings, and clean clothes; tending to patients' nutrition; and keeping insects and vermin at bay.

On the bright side, today's average citizen knows far, far more about the causes and effects of disease and infection, pharmaceuticals, wound-dressing procedures, cleanliness, nutrition, and many other medical procedures than did learned physicians of the Civil War era. If we don't know this stuff already, there is a huge amount of easily acquired literature on the subject that can be stored away until the day of crisis. In Civil War terms, all of this knowledge would be seen as nothing short of pure magic.

The road ahead is arduous, but examples of those who have actually succeeded at this business are many. The motivation to assist a friend, relative, loved one, comrade, or fellow human is high among free people.

This is how we proceed.

Shelter



Survival nursing shelters are quite different from regular survival shelters, and that difference can be tough to overcome. Nursing shelters must be warmer and dryer, with the somewhat contradictory requirement that there also be good ventilation and light. In a pure survival circumstance you may sleep in a damp hole in the ground, yet patients suffering from malaria or recovering from extensive wounds can't do that. Similarly, in most circumstances nurses cannot easily move their charges. Survival nurses must also battle bugs, vermin, and other little critters that like to prey on weakened humans.

Depending on levels of security required in your specific circumstance, just about anything could be used as a structure in which to provide long-term survival nursing care. Our nurses thought of motor homes, campers, horse trailers, and even boats. Tents and tarps can be used as temporary shelters virtually anyplace, even in backyards or park areas. In Vietnam, tunnels and caves were used as hospitals.



Because hiding is often important to survival nurses, it may be necessary to use alternative shelters such as this root cellar.

LOCATION

Location is not only important to many activities in our society, in many cases it is all there is. Hand grenades, dancing, and McDonalds' hamburger joints come to mind as excellent examples. Get location even slightly screwed up for any of these and the entire enterprise goes in the tub.

Shelter deployment in the course of survival nursing is similar. In some instances, some especially able and innovative nurses may conquer great obstacles by heroically overcoming common problems such as inadequate laundry facilities, disinfecting and cleaning requirements, or drug procurement and storage. Yet a typical survival nurse will never make a go of it if her shelter is poorly located.

The rule is that in all but the most dire instances, a survival nursing station should be within easy working distance of adequate fuel, water, and food. You *must* creatively envision where these needed inputs will originate. Walking a mile to the river for two 5-gallon cans of water twice a day, for instance, may be okay, but not if you also have to go that far

for food and fuel! There won't be enough time to do all this *and* care for patients in a healing environment.

First and foremost when considering a location for a nursing structure, make a brutally honest assessment of the level of threat you really face. Is it roving bands of irregular anarchist looters; plundering, undisciplined soldiers; or irate, fascist government officials likely to shoot your patient and haul your weary ass off to jail? If it's the latter, determine for what reason the authorities are looking for you or your patient and with what thoroughness and vigor will they search. Government officials, for instance, will expend a great deal more energy looking for someone hurt in an assassination attempt on one of their own than they will looking for a kid taken out of an abusive, ineffective public (i.e., government) school by his parents.

Obviously, in many cases patients can be cared for secretly, somewhat like sick kids in the home. In other cases, special, carefully thought-through shelters will need to be assembled to hide both nurse and patient. Usually these situations are tough to predict. You just never know with certainty how the media will present an incident or how fellow citizens or government agencies will react to the discovery of your survival nursing station. (Heaven help you if they start describing it as a "compound.") The bottom line is, you must have a firm grasp of the *real* situation you are facing and who the enemy *really* is. In most cases excess caution is advised.

How survival nurses receive their patients will say a great deal about the general need for cover and hiding. Will your patients come from a field hospital that has to move quickly because of shifting enemy lines? Or are you a medical refugee deep in the inner city with patients who come from an over-worked, unsanitary, unsafe hospital emergency room? Again, a thorough, realistic assessment of your enemies in these and other situations will help you determine how "deep" your cover should be.

If your circumstances find you in a war zone or area of potential hostile gunfire, traditional measures such as setting up on the defensible high ground may be warranted.

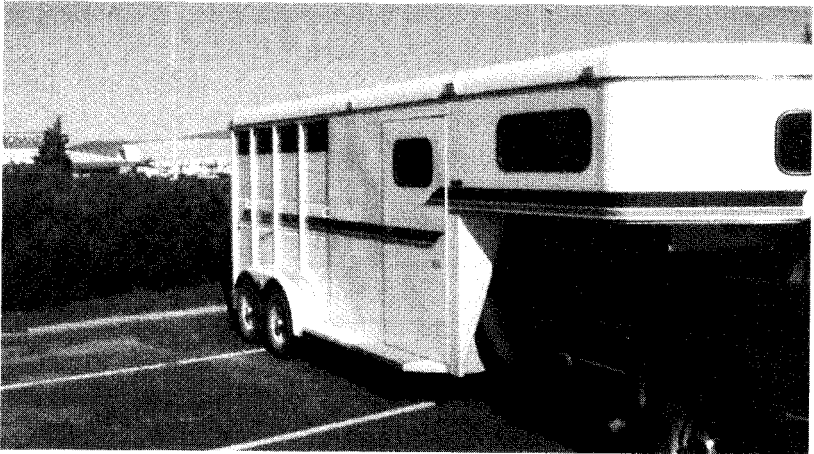

Nurses who have been there and done that recommend being alert to use of alternative shelters such as horse trailers or travel campers.

Nurse Betty Lou was in the Northern Frontier District of Kenya when her little aid station was threatened in an attack by irregular soldiers from Somalia called Shifta. In this instance, the Shifta had planned a raid based on inside information suggesting that all the citizen-soldier guards in their little village would be sound asleep by 2200 hours. The

Shifta also assumed that because of bureaucratic regulation and onerous record-keeping requirements, few of the soldiers would be issued ammunition for their rifles. The purpose of the raid was to capture cattle and guns as well as to spread terror and disorganization.

But the raiders made one fatal error: they woefully miscalculated how long it would take to sneak up the mountain to the village where the nursing station was strategically located. The first indication Betty Lou had that anything was wrong was when she heard shouting in the village down the hill.

Apparently one of the guards went out to make water at dawn and surprised a raider creeping among lava rocks and scrub brush 200 yards below. The raider screamed in surprise, causing the guard in turn to raise an alarm. Perhaps due to their long, stealthy, unnerving approach, other raiders down in the gullies lost their cool and commenced to fire their weapons ineffectively uphill at mostly nonexistent targets.

Betty Lou ran from her sleeping room to the medicine shack, a small 12 x 14-foot frame-and-tin structure. Several rounds cracked high through the tin siding without causing damage. After a bit, the screaming tapered off downhill and moved toward the cattle kraal.

There were numerous casualties, but only one required her care. Two raiders were killed by gunfire, two villagers were trampled flat by cattle, and one unfortunate young boy on his way to herd the cattle to pasture for the day lost his testicles to a trophy-hunting Shifta. This latter case, so typical of survival nursing, required instant attention lest the lad bleed to death. Then there had to be long-term care to nurse him back to health. The little fellow's family completely abandoned him after the incident.

No matter where you locate your physical shelter, usually it is best if the facilities are kept somewhat separate from nurses' living quarters. All the nurses I spoke with mentioned this concept. This, they claim, minimizes personal infection, disruption to the patient, and impact on other nursing duties. It also facilitates disinfection and keeps such day-to-day activi-

ties cooking separate from the nursing area. Smells from cooking food, for instance, can cause nausea or great anxiety among patients.

TYPES OF SHELTERS

Virtually any structure that can be kept warm, dry, and clean can be pressed into service as a nursing shelter. The first rule of thumb when selecting a room or structure for a potential nursing station is to look at it from the standpoint of a germ trying to live there. Ask yourself, can virtually everything in the shelter be washed down with disinfectant? If not, taking up germ-harboring carpet or tearing down dank cloth draperies may be wise.

When conditions permit, Betty Lou likes to use a small, semipermanent tin-and-frame building as her nursing "hospital." She has three beds in the room but prefers to handle as many of her charges as practically possible on an outpatient basis. Because of filthy living conditions in the nearby village, she sometimes keeps burn and accident victims at her station an extra day or two until their wounds have a chance to close



A survival nursing station in deep Africa.

and start to heal. A doctor makes regular circuit calls in her area, but she alone still has to treat many minor emergencies ranging from machete accidents to anthrax to childbirth. In truly life-threatening situations, she sends the patient to the hospital or gets on the radio for specific recommendations. The nearest government hospital is over 100 miles away, 10 hours by truck. Most of her charges resist going to the real hospital, perhaps because of the expense, separation from family, or the reputation for dirt and infection at the government facility.

One thing Betty Lou is certain about: she requires her nursing area to have a cement pad below and a roof of tin as opposed to cheaper, more common thatch. New thatch is okay, but after a year or two spiders, rats, and other vermin infest it, creating a very unsanitary condition. She hasn't resorted to this measure yet, but if disease becomes rampant and disinfectants no longer work, she can tear down her tin-and-frame building and expose the pieces to the sun for 30 days. Then she can reassemble or assemble it using new materials. Otherwise, washing down the cement pad and interior walls with strong disinfectant is easy, she claims.

Rooftop convalescent areas are workable in some places. I saw one such operation in Cuba during the dry time of year. A temporary shade structure was erected out of tarp, under which patients mostly stayed. It was an ideal situation during the Cuban winter and spring dry season. Sun and wind seemed to purify and brighten the area. Certainly the patients' spirits were lifted by the beautiful setting, and they were hidden from view.

Kate Cumming, the Civil War nurse, along with several other modern-day survival nurses, liked the idea of using tents as nursing shelters. There is a certain charm to this concept. Tents are quick to erect, relatively inexpensive, highly portable, easy to hide, and, in the hands of experienced users or quick learners, reasonably energy-efficient. (Generally, tents are only energy-efficient in the southern two-thirds of the United States, but even up north they are workable when deployed by nurses who understand concepts of cold-weather-

er camping.) Tents are ideal when placed in unlikely locations—city survivors can erect them in bombed or burned-out buildings, in old cellars, on rooftops, or wherever. Finally, if disease becomes a threat, tents can always be burned without irreparable loss to the survival nurse.

On the downside, tents can be dirty, damp, drafty, and dark. Medical doctors don't like tents for these reasons. Also, too difficult to work in, they contend. Try hanging a patient's chart on the wall of a tent, one M.D. told me. Light, warm, airy conditions are good for patient morale (although Ms. Cumming reported that, in the face of the fact that the South was too poor to afford candles, her patients nonetheless thrived in the dark). Also, control of insects and vermin can be more difficult when tents are used as nursing structures.

Some of the sanitary objections can be overcome by laying out a big, heavy, vinyl tarp to separate tent and contents from the earth below. These ground cloths can be pulled out at regular intervals, thrown over a line between two trees, rinsed off, and then scrubbed down thoroughly with disinfectant.

Most dirt inside a tent, even those with adequate ground



Doctors tend not to like them because of sanitation and space limitations, but tents can make for a quick, cheap, and easy survival nursing shelter.

SHELTER

13

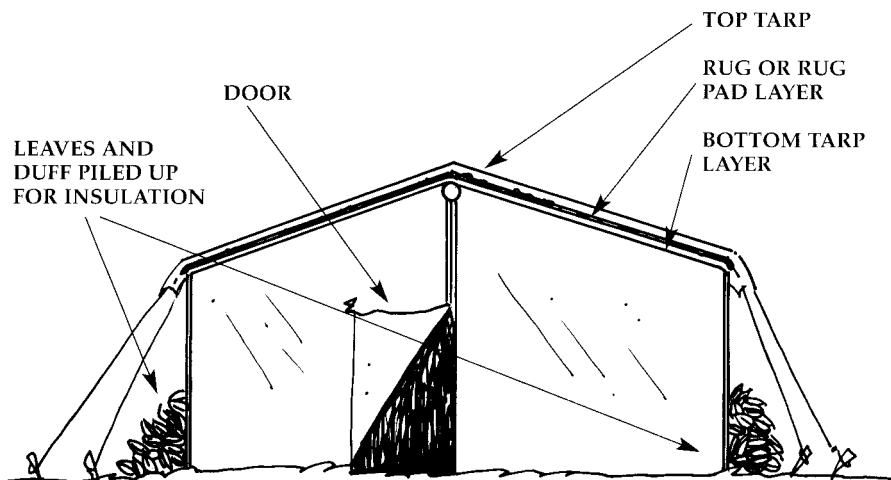

Wall tent rigged for cold weather.

tarps, gets tracked in through the entrance flap. Try rigging a fly over the entrance to keep mud, dust, and debris out. Also, use a very generous entranceway ground tarp, perhaps in conjunction with an old-fashioned boot scraper and coarse entrance mat, to keep dirt as far away as possible.

Dig drainage ditches around the tent sufficiently deep (6 inches or more) to direct rainwater away. Any other surface water in the area must also be kept from running under the tent's ground tarp.

Some tents are rigged over wooden floors or even have semipermanent wooden-frame bases. This is not a good idea for nursing shelters unless the floor is concrete, experts claim—it is too tough to clean the wood properly. Cement would work, but other than in places such as abandoned city garages and parking lots, cement pads will probably not be available unless by fortuitous circumstance you find an abandoned farm building with a cement floor out in the country.

Tents for survival nursing must be 8 x 10-foot or larger wall tents. Eighty square feet is still barely enough space for a

work area and two cots. Workers and patients must be able to stand up straight in the shelter, ruling out most dome, tepee, pup, and mountain tents unless it is a temporary emergency.

Some air movement through the tent helps purify the atmosphere and keep disease in check. Open flaps allow psychologically pleasing light in but also flies and other insects if such are thereabouts. Dark is better if this factor becomes a problem, but screens can be a help here.

Cold-weather tents are built with a stout ridgepole running through the top down the center of the structure to support all of the necessary insulation and rain coverings. To reinforce a cold-weather tent, throw a heavy tarp on top of it that reaches all the way down the sides to rope stays. Then throw a heavy piece of carpet pad over this and then another tarp. Even a relatively small wood stove will thoroughly warm a triple-covered tent when the sides are also insulated and protected.

Bales of straw may not be available to survivors, but we use them around our tents when camping in the snowy mountains during September and October. Heaped-up leaves, pine needles, and duff will accomplish the same goal while simultaneously providing a great deal of camouflage. Out in the mountains I have banked up brush, leaves, and duff and then covered my tent with fresh-cut pine boughs. Hunters have ridden their horses within 30 feet of my tent and passed by without ever seeing it.



Remember, nursing areas have to be clean and cleanable, warm, dry, ventilated but not breezy, and within working distance of food, water, and energy. Proximity to modern conveniences such as sewing and laundry machines is extremely helpful if possible. An important consideration is to avoid idle curiosity seekers or, in the instance of deep hiding, officials who may be searching for you or your patients.

Chapter 2

Water



Water is one of the “big five” of any survival situation, but it is especially essential for the successful operation of a survival nursing program. Survival nurses will have to supply more water in better, purer condition than would be required for more straightforward survival. This is the challenge. Yet according to our nurses who have been there—done that, water and its constant clean supply is the one element of survival nursing that breaks down first.

One nurse, Jackie, claims that “it is virtually impossible to bring enough hot water to nursing retreats to run them successfully.” On the other hand, she admits that her experience is limited and that others have actually pulled off survival nursing programs amid truly grim conditions.

Normally, you figure on about 1 gallon of drinking water per person per day. (Some nurses claim they promote healing by having patients drink larger than normal quantities of water. Paul, our only male



Water storage barrels.

survival nurse, claims to have nursed a patient—badly cut and busted up by a large circular saw—back to health largely by requiring consumption of 1 quart of water per hour 24 hours a day!) This does not include water for food processing, cooking, cleanup, sanitation, or laundry. Patients must be bathed and kept far cleaner than other survivalists, who often sink into an almost animal-like existence. Floors and walls must be scrubbed down repeatedly. Food preparation must be much more sanitary, thorough, and nutritious when convalescing patients are involved. And then there is laundry figured in numbers of mountain-sized heaps rather than numbers of pieces. Even laundry water must be cleaner than is normally expected in a traditional survival circumstance.

WATER PROCUREMENT

Where to get all this necessary water for a successful nursing program?

For starters, do like the mountain men of old—don't make camp far from water, and don't think of holing up unless you

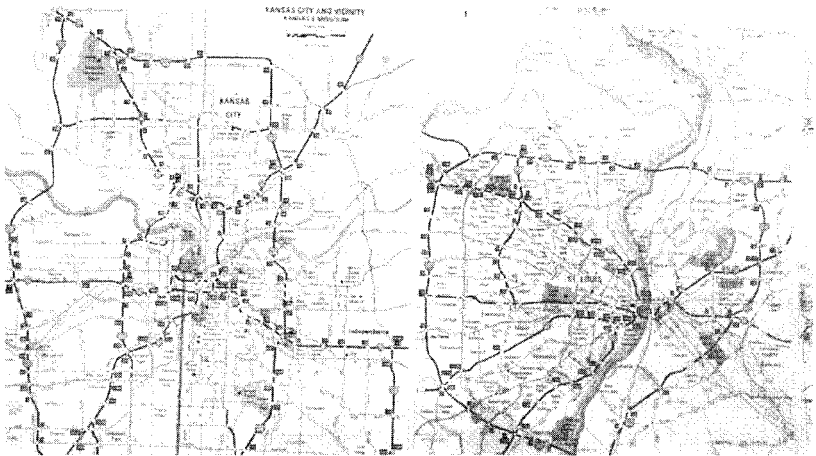

Most large North American cities are located on or near rivers or other bodies of water.

know where water will come from for the retreat. In some cases these grizzled old veterans made dry camps, but it often was for some silly reason, which soon became the subject of campfire legend: “The mosquitoes were so bad they threatened to carry off my roast rabbit,” or “There were hostile outlaws on the river,” or “The bears were working the elderberries and I didn’t want to camp where I had to deal with them!”

In many cases towns and eventually cities sprang up on old, convenient campsites near good supplies of water. (Early water transportation also had something to do with it.) Look at modern road maps and you will note that almost all North American cities are built at rivers and lakes. Given that, city survivors frequently have an easier time coming up with water supplies than some ill-positioned rural survivors camped far from any surface water.

Developing a Spring

Developing a spring is an old, old pioneer trick that I personally have not seen done in dozens of years—so many years that probably the method should be explained again. Modern,

lightweight, cheap plastic pipe makes this job much easier than it was in the past.

Developing a spring takes advantage of small amounts of water weeping or seeping out in a narrow gully or down the face of a hillside. Often these sources of water are small, not enough to be of much practical value unless collected into a holding area. These seeps may also be seasonal, tapering off to little or nothing during dry times. Frequently the water runs downhill a few feet, only to be reabsorbed into the ground, lost forever.

Spring water of this sort seeps downhill following a layer of impervious clay. This clay layer, deposited by some ancient act of nature, runs out onto open ground, carrying water with it. By developing a spring in this area, you can increase the natural water flow, sometimes dramatically. By running constantly 24 hours a day, sufficient water can be collected for survival nursing purposes.

We take advantage of these natural seeps by moving 3 to 5 feet uphill and digging a slit trench down to the clay layer. Shovel out a trench about 5 feet wide across the seep and perhaps 6 feet deep behind it uphill. Be careful to stay on top of the impervious clay layer while digging or the water will be reabsorbed into the soil as soon as it flows past the clay.

Having dug a trench exposing the clay layer, the trick is to place a small dam on the top of the clay that catches and holds the water as it seeps out. This little containment can be nothing more than a couple of 2 x 6-inch planks stacked edgewise. You can also use sections of 55-gallon drums cut out in a U to catch and hold the water. Steel drums are quick, easy, and surprisingly effective because of the thin lower edge that seals nicely in the bottom clay layer. They are temporary, however, because complete rusting occurs in 3 to 5 years. Depending on one's circumstance, this may be enough use of the spring.

Semipermanent spring development is accomplished using a cement box or a home-constructed fiberglass one. Some really large developed springs will generate enough water for a 1,000-gallon septic tank of either cement or fiber-

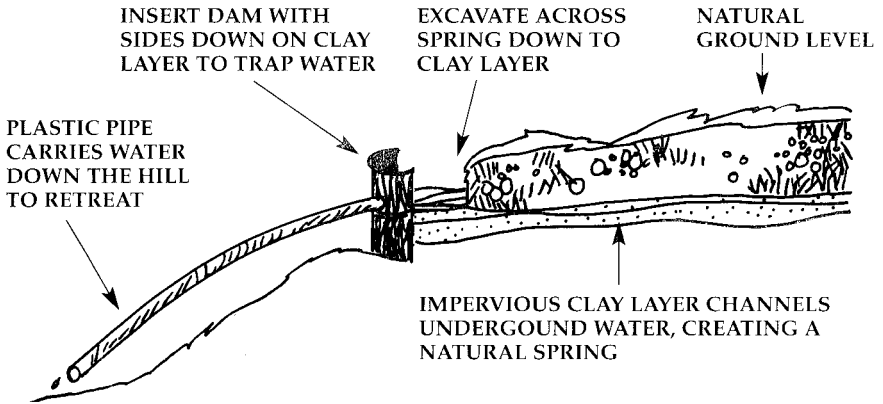

Developing a spring for potable water.

glass. These tanks can be placed with backhoes, provided the operator is skilled and has some previous experience digging around natural springs. Some survivors use a second large tank or cistern to collect water, especially when seasonal flows are weak.

Whether it's a large or small spring, the catch basin not only holds the water but purifies it a bit by allowing sediments to settle out, collecting at the dam. Depending on the season, these sediment traps should be inspected and cleaned about once a week.

Modern technology makes transporting and using trapped spring water quick and relatively easy. No sense carrying buckets. Instead, bore an inch-and-a-half hole in the top front of the catch basin and install a length of inch-and-a-quarter plastic pipe. Caulk around the pipe to prevent leaks, and string it downhill to the vicinity of the retreat. It doesn't take much elevation decline to the retreat to produce a considerable head of water pressure. In some instances water can be moved as much as 200 to 600 feet, depending on the terrain and quantity of plastic pipe available.

Catch basins at the spring can be adjusted for size. When seepage is very little, larger basins hold more water, collected

in off times or during the night when retreat use is low. On the other hand, exercise care during times of higher flows. Overflowing water will wash out even elaborate catch basins during spring runoff.

Drilling a Well

Driven wells can be located in such unlikely places as backyards, unoccupied corner lots, or even parks or government land, but they require expensive equipment and lots and lots of energy as well as some mechanical sense. They are really only practical to about 30 feet, or five 6-foot sections of well pipe.

Some survivors have used small, portable one- and two-man well-drilling rigs or special shallow-well-driving pipe to punch down their own private wells. Power drill rigs cost about \$3,000 (they can also be rented), and they can be used to drill multiple wells. At the time of this writing, Deeprock Company (2209 Anderson Road, Opelika, AL 36803) sells a personal water-well-drilling rig called the Hydra-Drill.

Driving-well gear use a special well point ordered from a full-service plumbing supplier, extra-tough couplings, and a special cap that protects thread ends on the pipe. All of this is available from Lehman Hardware Co. (One Lehman Circle, Kidron, OH 44636) if your local plumbing shop cannot supply it or, more probably, has no clue what you are talking about. Other tools required are a shovel, water buckets, long pipe wrench with pipe handle extension, second pipe wrench to help unscrew the pipe sections, and an 8- or 10-pound steel maul with long handle. Six or eight cement blocks and some planking will be needed to build a platform on which to work till the pipe sections are driven down sufficiently into the ground.

One man whales away with the sledge while the other turns the pipe with the pipe wrench while simultaneously pouring water into the pipe and around it. Progress is easier in the wet time of the year in ground that is not full of rocks and cobbles.

Each hand stroke of the maul should drive the pipe another 1/32 of an inch into the ground. This is really hard work. You will know when water has been reached by noting that water is no longer standing in the pipe. It runs away into other water when such is reached below the surface.

Either hand or electric pumps can be used to lift water from these wells. Lots of effort is required, but special hand pumps are available that will pull water from as deep as 150 feet! These and many other tough-to-find hand pumps are available from Lehman Hardware.

Other Sources of Water

Potable water can be caught from roofs and other large, open expanses such as parking areas and even streets. This only works where rainfall is consistent enough to be reliable. Fiberglass and plastic containers can be used to catch water during times of rain. Use plastic tarps strung out with ropes to channel water into your containers, or simply divert water coming down through downspouts or along little seasonal water courses.

Ice is a source of water, but is not useful unless melted first. No animal, humans included, can live on unmelted ice as a water source. Too many calories are sucked out of the body in the course of melting ice using body heat alone. Ice is okay so long as sufficient stores of energy are available to thaw it as well as pots and pans to collect it. The same is true of boiling water to purify it. Too much energy and resources are consumed, so boiling only will be practical for a few of us, and then only temporarily.

Keep in mind that patients will probably drink 1 gallon or more of water per day. Food prep, including minimal dish-washing and cleaning scrounged or home-grown food items, will take at least another 5 gallons per day. Personal hygiene requires some 3 gallons, and clothes washing between 12 and 18 gallons per load. Washing by hand may be necessary, but little water is conserved by so doing. Figure about one load of wash per day per patient. Water consumption under these cri-



Laying in a supply of plastic tarps and rope that can be used to collect rainwater is often a good precaution.

teria will be between 21 and 27 gallons per day per patient. Let's hope this won't have to be water that is packed in or melted from ice. Obviously it cannot be boiled water unless you've set up camp next to a lava tube.

Within cities and sometimes out in the country it is possible to buy water. Where there is a market and where water is available, this service seems to spring up. In fact, in some sections of Beirut, Lebanon, during the war years of the 1980s, water was only available from private sellers when all municipal supplies were kaput. Right now a neighbor of mine drives his Datsun truck into town every third day to buy 275 gallons of water for his home. This concept may not be possible or practical, but it is something to keep in mind.

CLEANING WATER

Spring water is okay to drink without further filtration or treatment: nature has likely done the job for you by straining the water through soil and gravel, trapping impurities. Conversely, all surface water should be filtered and treated, as should any water suspected of having originated in or run through a man-made area such as an old dump or abandoned mine. With any source of water, keep in mind that its job is to assist a patient along the road to recovery. Dirty, infected water, used even for laundry, is not helpful.

Surface water taken from open ponds, swamps, lakes, or streams must be allowed to settle for at least 12 hours in the original collection buckets. Carefully pour off the top nine-tenths of cleaner water; filter this water through 6 to 8 inches of coarse sand or fine gravel. Throw away the dirty bottom one-tenth.

Nice, functional filter racks can be built for a survival nursing station out of 2 x 6-inch wood planks. Place a piece of stout screen, perhaps backed by fine-mesh hardware cloth, on the bottom of the rack to hold sand in place. Fill with sand and set on a clean plastic tarp. Pour water through the sand, which is collected in another bucket at the bottom of the filter.

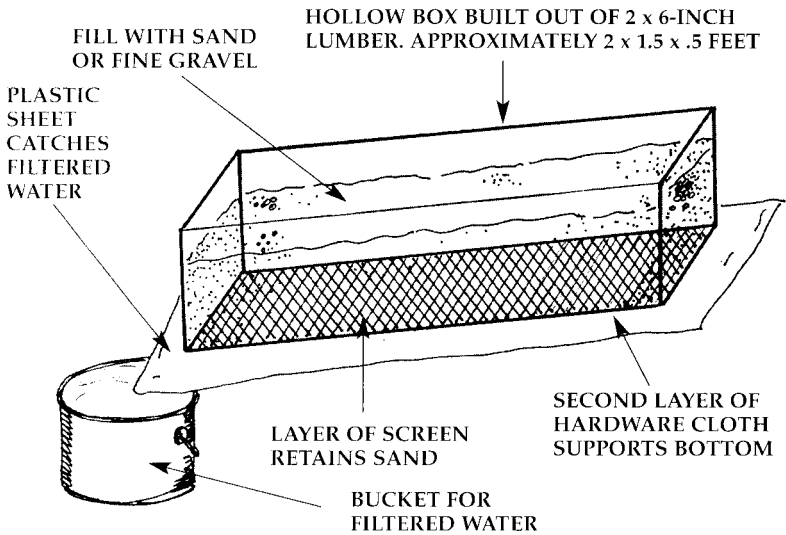

Water filter box.

These devices are easy and quick to build, but they require a bit of not always intuitive maintenance, especially if the source water is slimy. Sand in the filter, for instance, will get pretty grody after a couple of weeks' use. It will either have to be changed or cleaned regularly, depending on how many solids it must handle that made it through the settling process. Cleaning is done by spreading the sand out in a thin layer so it is exposed to hot sun. Allow all filter sand to dry thoroughly and then gently blow away any dried organic matter.

Any runoff water collected must be treated the same as swamp, pond, and river water—filtering and treating is necessary no matter how good it looks. Rain collection works much better in conjunction with some sort of cistern system (bladders, holding tanks, or blue barrels). Do not, however, make the error of trying to keep this water stored without first letting it settle and then filtering and purifying it.

After settling and filtering, place the processed water in closed gallon jugs or other such containers. Common household bleach is a cheap, easy, and effective means to further treat the water. Regular survivors use 1 liquid ounce of bleach



Bleach or chlorinating chemicals used to make bleach will be required in great abundance to purify water.

per gallon of treated water and 12 hours or more of time. This time interval is extremely important—don't treat water and expect to use it in 30 minutes. It won't be clean. Other marginally better chemicals are out there, but they are generally harder to find, store, and use, especially in a survival situation.

These levels of chemical and time are okay for basically healthy people and for laundry water, but the recommendation for survival nurses is to use 2 liquid ounces of bleach per gallon of treated water and to allow the water to stand 24 hours! This is a more certain mix, but it chews up scarce resources at an accelerated rate. This water is, however, safe for drinking, cooking food, and maintaining the personal hygiene of patients.

HEATING WATER

Nursing requires large quantities of hot water. If it can't be hot, it at least should be tepid instead of cold. Cold spring water can be made tepid by allowing it to sit in the sun in 5-gallon buckets. Some water-heating plastic bags are available

commercially that do a marginally acceptable job bringing water to heat for domestic use by exposing it to the sun. The Sun Shower is one such product available at camping supply stores. Survivors have also soldered shower nozzles and spigots to 5-gallon buckets that are hoisted up as makeshift showers. In 4 to 6 hours the sun will have either taken the chill off the water or actually heated it. (More on heating water in Chapter 4.)

Chapter 3

Food

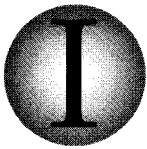

t's not a myth. Chicken soup really works.

That's the conclusion of our panel of survival nurses, who say that nutrition in many cases may be a last hope for patient care and recovery, but it is nonetheless a good one.

Kate Cumming referred to feeding wounded soldiers as "providing delicacies" to them. Many of Kate's days were also spent with the men reading, listening, counseling, and writing letters for them besides scrounging and preparing food. Fresh eggnog was one of her principal delicacies. Kate also records that in many hospitals in the South, small herds of cows were kept to provide milk to patients.

We ain't gonna keep cows at our retreats, but we may wish to keep rabbits, pigeons, or goats as part of a diverse survival food program. These critters are easy to keep, breed like crazy, and either eat virtually anything (as in the case of rabbits and goats) or will fly out to find their own food and water (pigeons). When combined with the crafty harvesting of game

animals, a well-run garden appropriate for your area, and a judicious reliance on stored supplies, a survival nursing station can provide enough protein-rich meat and vitamin-packed fruits and vegetables for patient and staff alike.

RAISING THE RIGHT ANIMALS

Goats, rabbits, and pigeons all require practice before they are workable options for survival nurses with no prior experience with such. Yet with a little bit of diligence and experience, most anyone can convert a collection of these critters into a handy and reliable meat-generating operation.

Pigeons and rabbits are still my favorite survival critters. Three doe rabbits and a single breeding buck will produce at least 100 eating rabbits per year. That's about two rabbits per week to go into stews, soups, and pies. Fifteen pigeon pairs that fly in and out for their own food and water will produce about thirty 1-pound eating birds every 15 weeks, or about two eating squabs per week year in and year out. Production for both pigeons and rabbits slows a bit in winter, but that is the time when more wild game can be taken.

A combination of the three is probably the best of all worlds. Goats are large, prolific, and easy to handle. Pigeons take care of themselves, mostly doing their thing unattended and unwatched. Rabbits will eat up most grassy green material around the retreat, turning it to wonderful compost.

I know I've almost religiously advocated the raising and butchering of these animals in some of my previous books, but indulge me again while I cover the basics for new readers. For my old-time readers, you may learn a new trick or two, especially as these topics relate to survival nursing. For those who want more in-depth information, a trip to a good library (especially one associated with a university with a good agricultural program) will be time well spent.

Goats

Betty Lou, the most rural of our survival nurses, likes

goats rather than rabbits or pigeons as survival meat animals. "When I need a real meal, a nice 30-pound kid goat is just wonderful," she claims. Three nannies will produce between six and nine young per year, depending on breed and general living conditions. When butchered at 18 weeks, they provide enough meat for 3 to 4 weeks each. In a nursing survival situation, every single ounce of good is wrung from the critter by boiling the bones for meat soup.

"Feed for these guys is very easy," Betty Lou continues. "They eat everything." The problem as I see it is to keep them from eating *everything*, including the garden, roses, pheasant bait, doormats, and backpacks!

Goats are large enough that preserving their meat in the time between butchering and consumption might be an issue. They are probably too large to ignore while also being too small to warrant firing up the jerky rack.

Rabbits

For rabbits, individual cages about 18 inches square with a front flap access door must be provided, one for each doe and the buck. Cages are made out of 1-inch chicken wire and 1 x 2-inch wooden frames or out of 1-inch welded wire hog-

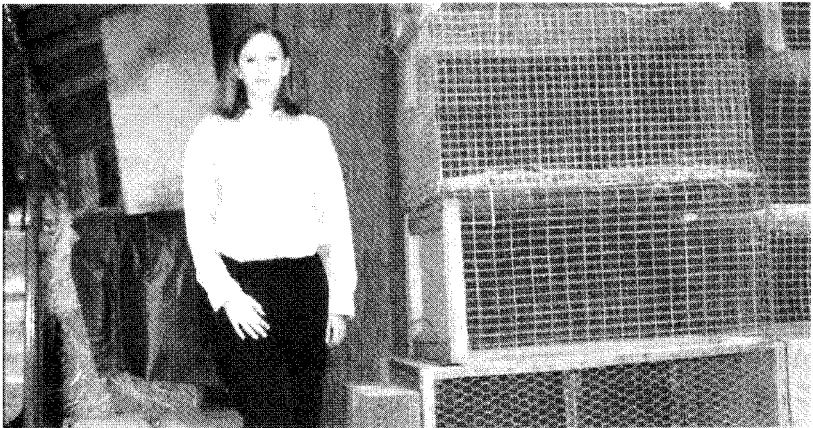

Rabbit cages ready for deployment.

ringed together. Use 1/2 x 1 welded wire for the bottoms. Does also require a covered 10 x 10 x 12-inch nesting box in which to have their young.

Raising rabbits is a skill that can be learned by anyone, but here are a number of tricks that often fail to find their way into popular literature.

Roll the rabbit over upside down in your arm and press your fingers around their works to determine sex. As compared to other critters, the buck is not particularly well-endowed. Does have standard equipment.

Do not breed does until they are at least 10 months old. After that, some owners with good supplies of food rebreed their does 2 days after the young arrive. This means that a new batch of young will come along almost monthly. Gestation is 30 days. Wean at about 25 days. This seems awfully hard on the does, but it is the way it happens naturally.

Separate the young into their own pens at 3 1/2 weeks. Butcher at about 2.5 pounds at 10 weeks or whenever you need a high-protein meal. Young kept longer than 10 weeks will begin to breed and fight with each other, resulting in a plateau in their growth cycle.

Keep larger breeds of eating rabbits rather than the smaller, pet-type breeds.

Buck rabbits are shy. Take the does from their pen to his pen or she may resist his advances. Keep in mind, however, that bucks do their homework very quickly under ideal conditions. Do not use a buck for breeding more than once a week.

Rabbits eat just about anything green that is nonpoisonous. I recall getting a piece of deadly nightshade in with dandelion greens I was feeding my rabbits. Being smarter and more vigilant than I, they rather carefully sorted the offending weed from the good stuff.

Be certain to cover all wood-framed cages with wire. Rabbits love to exercise their rodent prerogative by chewing their way out of their cages.

Rabbits are one of nature's best composters. Their droppings are a valuable addition to any garden.

Rabbits are butchered in a slightly different manner than most other critters. Cut off the head after bonking it with a hammer handle to kill it. Hang the rabbit upside down. Slit along the ridgeline between vent (bung hole) and the foot of the rear legs. Pull the skin off in a long tube. Then slit the belly from crotch to rib cage. Pull out everything, including kidneys, heart, and lungs, that seems to want to hide in the carcass.

Pigeons

Pigeons are often raised in a loft or roost. It doesn't have to be, but many people think of a pigeon loft as the attic of a house or other place high up. An old, ground-level chicken house works just fine as long as the pen is totally enclosed and your pigeons have an exit several feet above ground level from which to fly in and out.

Keep two things in mind when working with pigeons. First, common barn pigeons are also common homing or passenger pigeons. Treat them wrong at the start and they will return to their original homes. Second, pigeons are incredibly dirty. They carry virtually every disease and parasite known

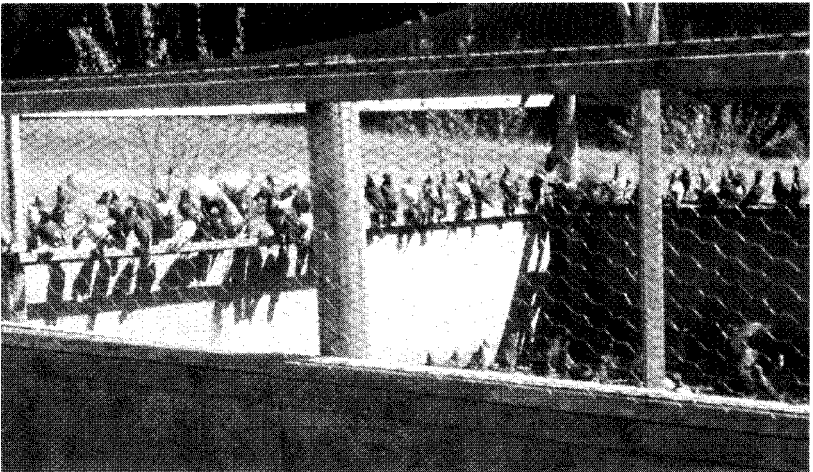

Pigeons are an easy-to-raise survivor's food source. They fly out to get their own food and water.

to man. Keep them away from nursing quarters, and don't spend much time in the loft taking care of them (they basically care for themselves anyway). Wear an old raincoat or slicker when undertaking light housekeeping chores involving pigeons. Leave the coat outside and wash up thoroughly before food prep or patient care.

Pigeons pair pretty much for life at about 8 months of age. Purchase or catch nesting pairs for new enterprises.

Pigeons are caught in old barns or under the eaves of houses or bridges at night using a powerful flashlight to blind them. Pen the captives in their new home along with a large supply of food and water. Keep them penned about 15 days. Some may start to go out of condition and die: if that happens, open their loft access door, allowing them to go out for their own food and water as well as to exercise.

Hanging a powerful magnet affixed 4 inches over the pigeons' food dish can speed up the acclimation process to their new homes. (Magnets seem to assist in scrambling a pigeon's prior homing codes.) Take the magnet away a few days before opening the loft.

Pigeons nest quite nicely on a 2 x 6-inch plank fastened high up in a loft. They will naturally pick out little nooks and crannies on which to lay their obligatory two eggs. Propagation of young is assisted by the fact that males take over all nesting duties at about 15 days so that the female can go start another two-egg clutch.

Young squabs are taken for the pot at 8 to 12 weeks, just before they begin to fly. All pigeons are butchered by wringing their heads off, then dipping the carcass in hot water of about 165° F and plucking them clean. Some owners skin squabs, but in a survival context this edible skin is valuable. And plucking only takes marginally longer on young birds.

Harvesting Game Animals

It is interesting to note that two of the most urban of our advisory nurses, both of whom currently live in what would be described as a rural subdivision, recommend *against* raising



Survival nurses should use their guns only in an opportunist circumstance to take game, never to hunt or for anything but very immediate defense.

even small livestock. It's too much work and problems, they say, tending to the needs of critters when you have more important needs of patients to consider. Their point is that there are not enough hours in the day to get everything done, and they are probably right.

It is much easier to let substitute livestock in the form of wild game raise itself, both our nurses say. This is their system, which actually has a great deal of merit if you live in an area rich in game, can stand the uncertainty about what will go in tomorrow's pot, and can handle a .22 rifle or a shotgun accurately.

One gal buys dirty, spilled, swept-up, gravelly grain from farmers and from a grain terminal that happens to be nearby. The other one prowls rural areas, where she looks for spilled grain piles along the road or out in fields. She sweeps these harvest accidents into burlap bags that she takes to the retreat. In both cases they attempt to accumulate six or eight 80-pound bags of grain-rich sweepings.

They spread this grain out on the ground in front of their retreat a bag or two at a time. During winter, everything else is dead and eaten up, and critters quickly learn about this free largess. They come in year round for a meal, and mature critters are harvested as needed. Rabbits, squirrels, possums, geese, turkeys, pheasants, and deer all come to the bait.

Jackie sets out tiny fishhooks on 8-foot lengths of monofilament line baited with corn. She claims to catch innumerable pheasants and even the occasional wild turkey and goose with this little time-saving device. Wild Canadian geese are becoming much more abundant, having altered their life pattern away from migration to become resident nuisances in many communities. They should be considered an excellent food source.

During the fall and winter, these gals claim to take at least one critter a day, all of which eventually finds its way into the pot. Not all are immediately eaten, since there is seldom that much demand. Jackie bagged five whitetail deer over her bait last year. Each one provided enough meat for at least a month.

GARDENING

Gardening is another of the survival nurse's vital food programs. In addition to protein, most patients will require green vegetables high in fiber and vitamins. Sans grocery stores, gardens are the only place to acquire these delicacies. Like animal care, good gardening can be a vast topic worthy of many volumes, but I will cover some of basics and tricks as they pertain specifically to a survival nursing situation. Once again, a good reference book on gardening techniques is a must for any complete survival library.

Learning to garden in any specific area requires 3 to 5 years' practice. Even experienced gardeners will be temporarily flummoxed in new growing areas, as garden culture is dramatically different from one place to another. We, for instance, cannot grow corn reliably in our area, but potatoes do remarkably well. Other areas with other soil types are noted for good corn crops, while pervasive diseases keep potato yields very low. I do raise corn, some onions, and tomatoes, but only as a kind of exotic experiment. In survival circumstances, unless I knew the patient had to have these, I would stick with green beans, lettuce, spinach, carrots, zucchini, and potatoes.

A good trick to get started is to simply look at what the neighbors are raising. I wish I could be more definitive in this area, but it would take a whole volume starting with basics such as sand, silt, and clay content—as well as the organic matter—of which soils are constructed. That still wouldn't really meet the needs of most readers to the extent of growing stuff practically.

Nonetheless, survival nurses will need some kind of high-yield garden, and gardens can be produced any place there is sun, soil, and an absence of frost for at least 70 days. Here are a few tips on how to start:

1. Start to practice raising a few common, easy vegetables now. Cost savings at the supermarket will be considerable, and the experience you will gain under normal conditions will be invaluable under survival conditions.

2. Observe what the neighbors raise and how they raise it. Do not be shy about asking questions.
3. Don't get caught up in raising exotics for your area. I really like tomatoes, for instance, but here in the mountains they do poorly. I raise tomatoes for fun but would not do so in a survival setting. They take too much time and effort for an uncertain yield in my area.
4. Note that lettuce and spinach are not really of much value other than to brighten some summer meals. These two cannot be preserved in any sensible fashion (it takes a 30-foot row of spinach, for instance, to produce one package of preserved product).

In general, 99 percent of the nurses in North America will be able to raise green beans, carrots, lettuce, spinach, potatoes of some kind, zucchini, and perhaps winter squash. I raise my garden in midsummer; you may raise yours in early spring or late fall in southern latitudes. But the point is, you *can* produce food if you try.

HUNTING AND GATHERING

This leaves one last area of food procurement: hunting and gathering. Keep in mind that of all the energy-inefficient activities you as a nurse will *not* be able to engage in, sport hunting is the principal one. Nurses will be too busy to even think about an activity that could likely return fewer calories than are burned in the process. They may take game, but it will only be targets of opportunity.

Use of traps is always recommended instead. Betty Lou likes to use steel-wire snares for game getting. It's tough to argue otherwise—wire snares are cheap, convenient, small, light, easily set, and very effective for just about anything from beavers and rabbits to porcupines and deer. Even if you are unsure of game trail locations, you can set great numbers of easily deployed snares and the simple law of averages will almost ensure that you will eventually get something. In my

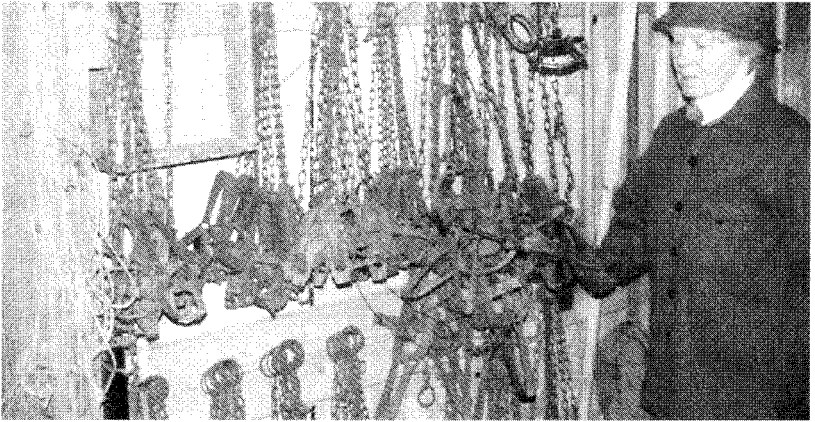

Sport hunting in a survival situation is not practical. Traps must be set for game.

case, I work very hard to keep deer, dogs, and porcupines *out* of my coyote snares. Deer especially seem to almost be attracted to wire snares.

Scrounging wild edibles is a specialized skill involving knowledge of a great many different plants, roots, berries, and nuts, most of which are not found in great abundance in any one place. In other words, if you are not resourceful, you may stumble around from place to place never really getting more than a mouthful of food. Some of this wild stuff is edible, but just barely. It tastes terrible. As with game hunting, you are in danger of breaking a major rule of survival—burning more calories in your search for the food than you would take in after acquiring it.

Luckily there are exceptions. Acorns, for example, are a wonderful, highly nutritious, easily stored source of food. You must, however, do as the American Indians did and wash acorn meat to remove its poisonous tannic acid. Removing tannic acid is not difficult or high tech, as it is very water-soluble. For survivors, the only trick is finding enough water for the job. Reasonably clean, filtered but untreated water can be used.

Wash freshly peeled and crushed nuts at least five times thoroughly in fresh water or until the bitter taste is complete-



Young cattail shoots in spring make wonderful eating. The flowers, roasted like cob corn, are also very good eating and nutritious.

ly gone. This detoxified nut meat is rolled into a fine meal and used to bake biscuits. Any bad bacteria carried over from wash water is killed in the baking process.

Dandelion roots and greens are another familiar, safe food source. Everything on a dandelion plant can be consumed, although older leaves become somewhat bitter and difficult to digest later in the year. Use earlier, light-colored leaves and peel the roots to reduce bitterness. Unlike acorns, bitterness in dandelions doesn't mean that they're unsafe to eat. They grow well very early and very late in the year.

Cattails are the queen of wild survival foods. If all else goes in the tub, again do as the Indians did—make your nursing retreat somewhere within working distance of a large bed of cattails. Everyone in North America can locate a bed of cattails, even in urban areas!

In winter, dig out or pull up the cattail roots. Cut into chunks to heat into a starchy, somewhat bland, but edible, nutritious gruel. In the spring, you can eat the buds raw or steamed until they have grown to 12 inches or so, after which they become overly tough.

The green cattail flowers that eventually become the dead brown knobs are good when young, either steamed or boiled, much like corn on the cob. During flowering, cattails release large quantities of pollen. This pollen substitutes for wheat flour, producing a tasty, nutritious biscuit. They are a bit heavy and filling but certainly edible.

FOOD PRESERVATION

Preservation of excess meats and vegetables can be done by canning, brining, freezing, or drying. Not all methods work for every product, but knowing how to do one or two of these will always add shelf life to your stores.

The important concept to remember is that at harvest time, everything happens at once. Sometimes there is only a matter of hours between maturity and spoilage. I think of it in terms of the 1,000-pound dead steer someone suddenly gives you and it's 120° F outside. Whatever you do, it must be done in a hurry. Harvest time is like that.

Yet again, I am only providing an overview of food preservation here, but it will be enough to get any survival nurse started.

Freezing

Freezing is almost always the easiest, quickest way to put up food. Most fruits and all meat are simply placed in sealed bags and frozen; vegetables need to be blanched first. At times we add sugar to rhubarb or take the pits out of cherries, but these measures are a matter of personal preference and convenience, not necessity.

Potatoes, beans, corn, carrots, and squash can be easily frozen, but internal enzymes in them must be killed by blanching before doing so. Dip dried, peeled, or broken vegetables in boiling water till the water starts boiling again. Then quickly cool these blanched vegetables in fresh, cold water. Before putting into freezer bags for storage, ends of green beans are cut off before they are broken in half. Potatoes are



Freezing vegetables is almost always quick and easy, resulting in a more nutritious product than any other method of food preservation.



Freezing meat is the quickest, easiest, most sanitary means of preserving meat.

peeled and cut into strips. Carrots are cut into wheels. Red beets are blanched whole, peeled, and diced.

Canning

Fruit and vegetable canning requires utmost attention to detail and to personal and equipment cleanliness. At first glance canning under survival circumstances seems impossible, but keep in mind that our pioneer ancestors successfully canned fruits and vegetables for years and years under very primitive conditions. Also keep in mind that survival nurses must do a first-class job of it; quality and safety under these circumstances cannot be compromised. Risks to the patient are already high without adding another threat.

Fruit and vegetable canning is done either in a water-bath canner pot or in a pressure cooker. Pressure cookers require far less time and energy, both fuel and human. The idea is to create sufficient heat to kill any enclosed bacteria while simultaneously creating a vacuum that draws rubber-lined lids down on the jars. Quality and safety are maintained so long as internal temperatures and pressures are sufficient to kill any microbial activity and a vacuum at the jar mouth is maintained.



Common supplies needed for home canning include jars, lids, and pressure rings.

Small fruits are placed in jars whole and uncooked. Cut larger fruits in pieces small enough to push into the jar and stack efficiently. Do not crush fruit in the jar; leave some space for the juice. Cover with a boiling syrup consisting of two cups water to one cup of sugar. Place lids and rings on jars and bring to a slow, rolling boil for about 20 minutes.

Vegetables are washed and blanched for a few minutes in boiling water as in the procedure used for freezing. Pack vegetables in jars, pour in boiling water to fill, and then cook in a water bath for from 3 1/4 hours for corn to 4 hours for beans to 1 1/2 hours for carrots. Given all of the discomfort from steam and heat, most people prefer to use pressure cooking, where the most lengthy procedure is for green beans—90 minutes at 10 pounds of pressure.

Meat or fish can be home-canned but, as a practical matter, drying, smoking, or freezing are far better choices. Canning meat requires more heat and pressure than retreat owners can normally assemble. Even using a heavy-duty pressure cooker



A relatively small 7-quart pressure pot useful for canning as a type of autoclave.



Water-bath canning pot ready for action on a small propane cooker.



Survival nurse with home-canned goods.

requires several hours of cooking time before the jars are sterilized satisfactorily. Large quantities of often irreplaceable fuel are consumed. Even then, only pint jars of meat are recommended. Any home-canned meat must be further cooked 10 minutes after opening as an added precaution against anaerobic toxins that may have formed in the jars.

Needless to say, meat cooked 15 minutes in a frying pan before canning, then 3 hours or more in the jars, and yet again after the jar is open will be destroyed of any aesthetic or culinary value or taste. Take the smart, easier way and freeze, dry, or smoke all meat and fish.

This brief explanation of canning is only an overview to get readers interested in the process. I can barely keep track of all the details myself. You can find complete instructions for these procedures in such cookbooks as the venerable *Joy of Cooking*. Almost every bookstore carries this volume, and every nursing retreat should have it or something similar in the reference library.

Drying and Smoking

Other than freezing, fish and red meat are best preserved by drying or smoking. Dried meat must be carefully reconstituted into soups and stews by the nurse for her patients.

Proceed as follows. Cut fish and meat into strips no more than a half-inch thick. Soak for 12 hours in a solution of about 2 cups of salt per gallon of water. Take this lightly brined fish or meat from the tub and place it over a low fire that also provides gentle air movement. Salting or seasoning at this point is not absolutely necessary, but some folks like to rub pepper or a mixture of pepper and Worcestershire sauce on their meat. Whether the meat is jerked or smoked depends on whether light, heat, and smoke or light, heat, and air movement are used to cure the strips of meat. Obviously smoking requires smoke.

Dry till the meat bends once or twice without breaking when it is sufficiently cool to handle. Drying beyond this point yields brittle, hard, black little chunks of almost coal-like material.



Fresh meat can be smoked or jerked in a common kettle barbeque.

Fish and red meat are easily kept salted in brine solutions. Modern plastic tubs and barrels make this easy. Prepare enough solution to completely cover all of the material to be salted. Add salt to the water until the solution floats a baking potato or an egg. Cut the meat into strips no more than 1 inch thick and place them in the brine.

Salted meat must be washed thoroughly before use. In some nursing situations, salt meat may not be advisable for patients. Also bear in mind that salting and later rinsing uses large quantities of what may be precious water.

Fruits and vegetables can also be dried successfully. I have even tried curing carrots in smoke, but they were only moderately tasty and not terribly long-lived. Dip sliced vegetables in a solution of 3 liquid ounces of bleach per gallon of water, place on drying racks, and, like anything else to be dried, move air gently through the food. Plums, peaches, and cherries can be dried successfully out in the open on home-built racks. In either case, survival nurses may wish to work with quicker and easier commercial drying racks when harvests are especially heavy.

STORED FOOD

So now we've looked at raising gardens and domestic animals, acquiring wild game and edibles, and preserving foods from field, garden, and orchard, all without saying one word about the source of food that will probably be the most common for survival nursing: stored food.

Stored food will undoubtedly be the principal, but not only, source of supply for many survival nurses, especially those who suspect that they may be thrown into a survival situation and who make plans now. What kind of plan leads to a successful food storage program? It's simplicity itself.

Start by doing a yearly purchase analysis, then double buy. This means that when you go out to the grocery or, for that matter, the hardware store to shop for current needs, evaluate all purchases on the basis of your long-term survival needs. If the item might have survival value, buy two of it and store the excess for the future. For example, say there is flour, salt, canned cranberries, donuts, canned peas, pancake mix, light bulbs, capers, nutmeg, and butter on the grocery list and 16d nails and a paint brush on the hardware list. Ask which of these will really be needed for a 1-year survival nursing program and which will store well. Obviously it could be flour, salt, pancake mix, light bulbs, and 16d nails that will be needed in the future and will store well, so these are the items to double buy on.

When patients arrive at the nursing station, it will be tempting to dip immediately and perhaps exclusively into stored supplies. Resist that temptation. All workable survival programs are built around using three separate sources of supply for each vital component of life. Better, for instance, to mix cattail pollen with wheat flour 50-50 now rather than eating heavy, 100-percent pollen biscuits later.



Operating an effective food program built on solid nutritional principles is essential to survival nursing. Civil War



Stored food supplies are important in any survival nursing situation.

nurse Kate Cumming reacted in absolute horror to military camp cooks who often put out rotten, poorly prepared, unnutritious food for convalescent soldiers. Even though they didn't at times have foods from the basic food groups to provide to the troops, serving spoiled food in a foul gruel-like mix even under desperate conditions was not acceptable. She reported bitterly that morale and health were so low as a result of bad food that it was a wonder the soldiers could even fight.

Modern survival nurses can and must do better. We know that our patients must receive three solid meals per day consisting of green vegetables, fruit, a protein source, and fiber. Personal taste and custom notwithstanding, spoiled, badly prepared food cannot be given to patients.

External Energy



Modern institutional nurses take for granted that they will be operating in a proper environment with enough heat, light, clean water, adequate energy, and food as a matter of daily life or in response to a single phone call. All that these nurses are expected to do is provide nursing care.

Survival nurses, on the other hand, must do their best to provide *all* of these things too, but under monumentally primitive conditions. To do this, survival nurses must be particularly concerned with the generation of energy.

“Regular” survival (if survival could ever be considered regular) consumes far less energy than survival nursing. Cool or cold patients recover slowly, if at all, because they must spend so much energy trying to stay warm rather than recovering. Therefore, nursing shelters absolutely must be warm.

Furthermore, foods have to be cooked thoroughly. Three out of five Civil War casualties

occurred as a result of sickness and disease, not wounds. Experts suggest a lot of this was the result of poorly or improperly preserved and cooked food.

Laundry must be done in jumping hot water. Survival nurses caring for one or two patients cannot risk the spread of disease-carrying vermin and therefore must use nothing less than scalding hot water to launder. As an added precaution, Confederate nurses during the Civil War insisted that all sheets and clothes, including underwear, be hot-ironed not because pressed skivvies looked better but because ironing killed little critters, both buggy and microscopic, in cloth. Some of our grandparents still possess this mentality.

Is it necessary to settle, filter, and treat wash water that will be brought near boiling anyway? Maybe they are over-cautious, but the nurses I talked to say yes. Boiling must go on for several minutes if everything is to be sterilized, they claim, so better to boil less, then filter and treat, in order to preserve precious energy supplies. Perhaps it all comes down to which is in greater supply, fuel to boil water for 15 to 18 minutes to sterilize it or disinfectant bleach.

Basically, energy for nursing retreats will come from two sources: it will be scrounged from renewable supplies or it will come from previously stored supplies. But both sources present problems. Scrounging can entail an unbelievable amount of work. When stored supplies are used, they may be pretty much irreplaceable. In other words, in a survival context, when stored energy is consumed and there is no other to replace it, your patient may die. He or she may also die from lack of care while you are out trying to make up a batch of firewood or scrounge a bag of coal from the seam behind the retreat. These are the horns of the survival nurse's dilemma.

Energy scrounging or production is generally done on a seasonal basis. This means that for one or two brief periods, survivors will work their behinds off laying in supplies of energy that will last for months or perhaps even the entire year. For us it's the 7 to 10 cords of firewood we put up early

each spring. This supply is gradually worn down until the following year when we replenish it again.

Survival nurses may be forced by the press of other duties, vagaries of the weather, demands of patients, conditions of garden harvest, or a multitude of other factors to put up a relatively small amount of energy as often as once a month. Only then can they take care of their many, many other tasks the other 29 days.

Do not count on replacing stored supplies. Wise survivors always plan for the stark reality that when precious stored supplies are gone, they really are gone. In this regard, survival nurses must often make very difficult decisions regarding how to use their energy supplies while trying to provide needed medical attention and take care of environmental issues in the form of a warm retreat, heated food, warm bath water, and sterilized linens. Realities strongly suggest that survival nurses will have to rely on a combination of stored and replaceable stored energy for all of this.

STORED ENERGY

First let's look at stored energy. Many new ideas are currently out there. Some are really half-baked and some are original and practical. An example of the former involved a fellow I ran into in North Carolina who uses all his spare pocket change to buy hexamine tablets and other small solid-heat tabs. These are his emergency fuel supplies. To be sure, he has accumulated boxes and boxes full of little green tubes containing little hexamine tablets. But to what end? He really can't heat water, the retreat, or very much food with these things. I am sure that if he tried, his entire supply would be exhausted in a matter of weeks or months at most.

This fellow simply believes that he has struck upon an easily affordable, easily usable, easily storable source of convenient survival energy. Obviously he has never tried to actually use any of these tablets in an emergency circumstance. Instead, he has convinced himself hexamine is a good idea and that's that.



Storage of gas and oil in various containers at the retreat is often vital.

It isn't quite as bad an example, but another self-professed survivor I know of is currently accumulating 3-, 5-, and 7-gallon cylinders of liquid propane (LP) gas. He might well have 30 cylinders of gas in his garage at this writing. Year in and year out we use close to 50 gallons of LP gas per month to cook food and heat water. Some of this energy simultaneously heats our retreat. In spite of these efficiencies, his energy supply will expire in 3 months maximum. Not a good plan given the high expense he has incurred for all of those little cylinders.

So what are some ideas that *will* work? New concepts are out there, but they will only be practical if survivors have means to use them. In other words, it takes an iron stove to burn firewood, a propane heater to utilize propane, and an oil burner to heat with oil.

In some cases, cleverness counts for additional points. Last winter, for instance, a survivor showed me a very nice spark-principle oil heater he built using an old pan from a Christmas tree stand, a 55-gallon steel barrel, and several lengths of stovepipe. (I digress, but it seems to me more of us should put more stovepipe in our stored emergency supplies. Long runs of stovepipe through a shelter wring every drop of heat out of

a stove, making for a wonderful improvised heater.) Basically this clever fellow set the barrel over the pan, into which he poured gallons of fuel oil. Daily refilling was necessary to replace oil turned to heat. The outfit was so simple he merely dumped new fuel in from a bucket rather than rigging some sort of gravity feed.

Stovepipe was set up to exit fumes and smoke from the top of the barrel outside. After a 6- or 8-foot run the pipe was very cold, creating a very heat-efficient unit all by itself.

A low, steady, almost invisible flame burning at the top of the oil reservoir consumed fumes from the warm oil. He started the heater by throwing in a piece of burning cloth or at times directly with a lit match. Heat output was controlled by

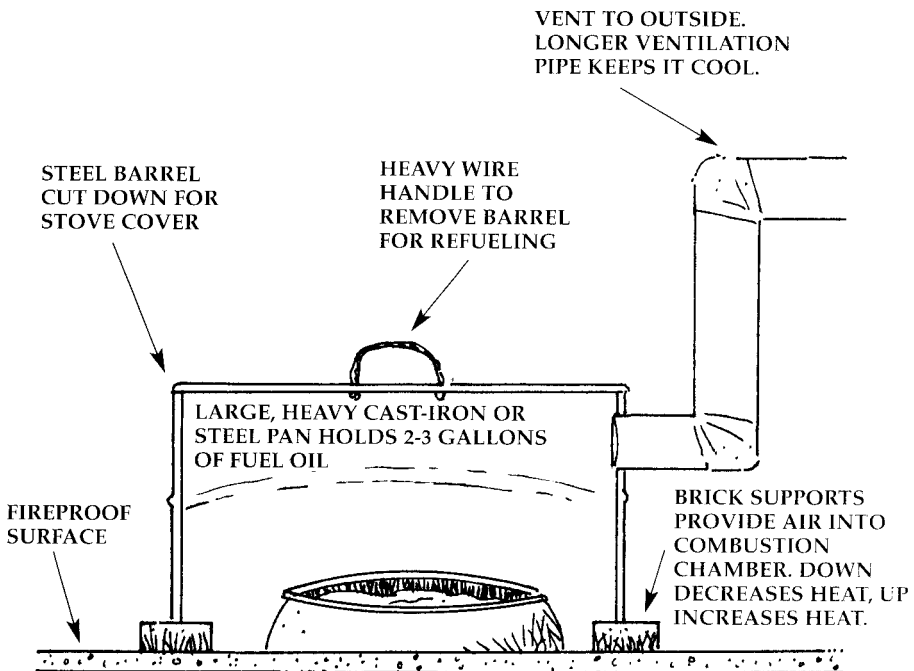

Homemade spark-type oil heater. A very low blue surface flame burns fumes from oil, heating the room. Refill once per day from portable can.



Common charcoal briquettes are another easily stored, practical source of energy for survival nurses.

raising and lowering the barrel on three small legs. If all of this seems confusing, see the drawing below, or go to a plumbing/heating shop to look at one of their spark oil heaters. The same principles apply.

When I was young it was still common for some home and storeowners to purchase coal in 100-pound burlap bags. They used coal in common, cast-iron, pot-bellied stoves to heat their shops and barns. Survivors in Kentucky, Utah, Tennessee, and North Carolina are currently laying in bags or boxes of coal as part of their survival energy programs. Some of it is purchased, and some is shoveled from small coal seams found in area roadcuts.

Survival nurses in coal-producing areas of the United States certainly could take advantage of this opportunity. Coal keeps well. Its only downsides would be some fire danger and dusty, dirty conditions that older, dust-producing coal presents. But again, be sure you have some sort of contrivance in which to burn this coal. No sense in trotting out to fill burlap bags when no method of using its energy is available at the retreat.

Another fellow is currently filling his apartment closet with 40-pound bags of charcoal. He purchases these at very low cost at the world-famous survival store, Wal-Mart! This fellow claims his charcoal burns so clean that he can cook and heat with it indoors in the open without using a vented stove. Sounds like a certain route to death by asphyxiation, but maybe he has a very drafty apartment or he heats and cooks very little.

At any rate, charcoal is a source of energy that will work for virtually any reader. Small stoves that use charcoal to heat are available at most full-service hardware shops. Reportedly one 40-pound bag of charcoal per week will provide sufficient fuel for a retreat.

When living in Africa we sometimes made our own charcoal, although there was lots of work involved in this project. Nowadays it seems the better part of wisdom is to use whole logs directly in a stove rather than coking them in an oxygen-free environment, especially when firewood costs lots of

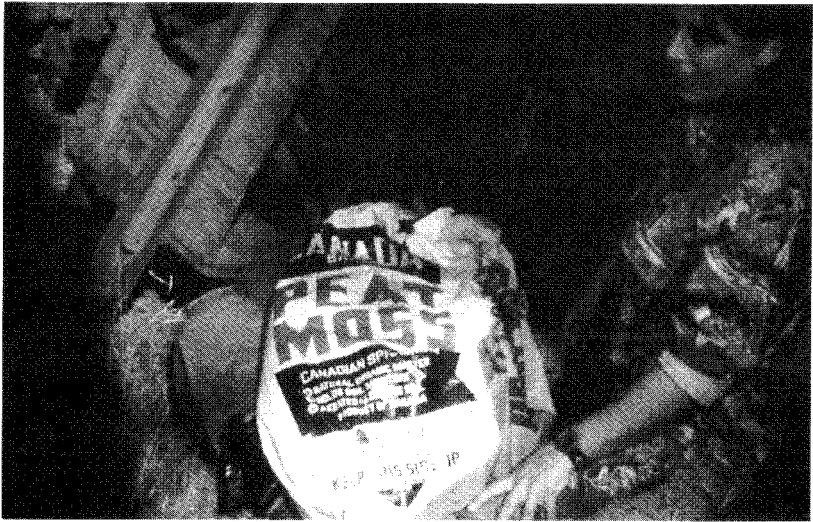

Some survivors maintain that common, store-bought peat moss is an excellent, easily stored, easily acquired energy source.

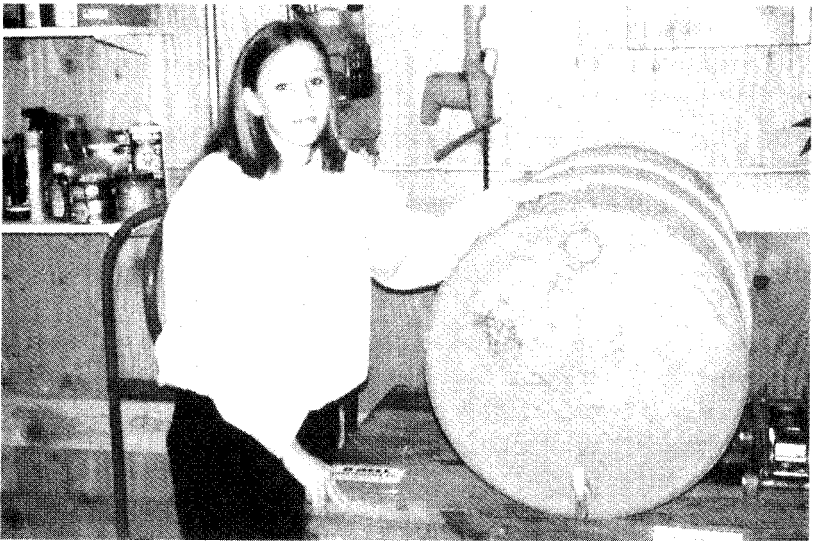

Gasoline can be easily stored and used from steel 55-gallon barrels.

dough and charcoal is frequently on sale at discount stores and supermarkets.

Another survivor swears she is going to use dried, bailed peat moss as an emergency survival energy source. Perhaps she can, but how much will it take, and how will she use it efficiently to heat and cook? The lady claims that single 4-cubic-foot bales last about a week, and that cooking and heating are easy in a conventional wood stove. A demonstration was at least superficially convincing. Setting peat on fire is not as difficult as I had first supposed. The resulting fire is not as clean as gas, but it is as clean as charcoal and heating oil. I suspect a homemade stove fueled by peat similar to the oil spark heater would work well. However, storing and burning peat is not an idea I personally would depend on without lots of practice and testing.

Most survivors' preference, including my own, runs to more conventional stored-energy sources such as "off-road" diesel, also known as number 2 heating oil. I include the caution that storage containers must be large enough to supply at least 12 months of energy at normal rates of use, be buried or at least well hidden and camouflaged, and that you be the owner, not some sort of lessee.

Fuel oil and gasoline can also be stored in 55-gallon steel barrels. Gasoline seems to go out of condition much faster than fuel oil, and oil, gallon for gallon, stores a great deal more energy. As a result, other than a small amount of emergency gasoline stored in barrels and cans, I—like more survivors—keep mostly fuel oil in reserve.

When purchasing diesel, ask for off-road diesel oil used by farmers in their tractors. This may result in a penny or two per gallon savings. Most oil dealers sell for less to farmers but don't want rank-and-file survivors to know this.

Fuel oil as well as gasoline can be given additional shelf life by adding to it a product called Sta-Bil (or Sta-Lube, a less expensive, generic version). There is considerable discussion about whether Sta-Bil actually works in diesel fuel, but the factory claims that it does. Read the container for treatment levels.



Sta-Bil chemical additive used to give long life to stored petroleum-based fuels.

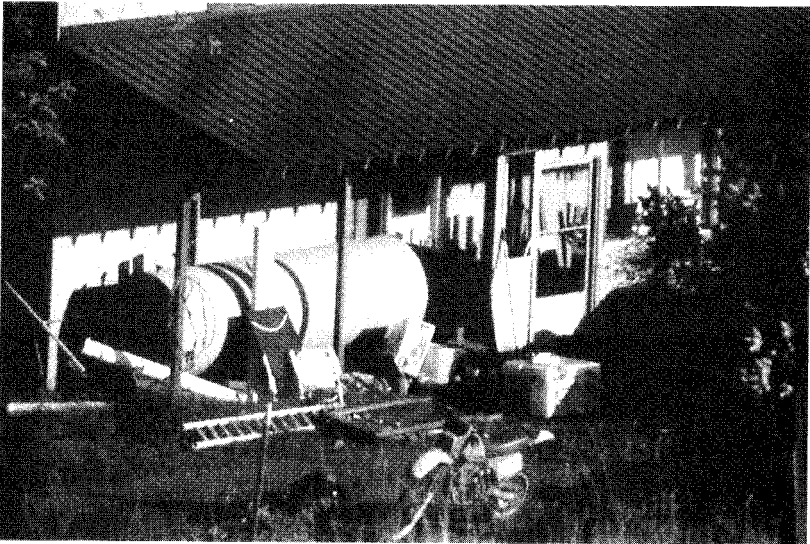

A large aboveground oil storage tank at a retreat.



Small 5-gallon LP gas tanks can be filled from a large nurse tank if proper equipment is installed before the main tank is first filled.

I use diesel fuel to power my tractors that, in turn, power my generators, explaining my love affair with large tanks full of diesel fuel. Without generators, all freezers go silent. Freezing food is not the only method of preservation, but it is one of the fastest and easiest.

LP gas is a convenient, potent, versatile fuel useful for everything from running generators and lights to cooking and heating. Small 5- and 8-gallon cylinders can be readily filled from large 500- and 1,000-gallon tanks if a bottom draw filler assembly is installed on a new, empty tank. (These assemblies virtually cannot be installed once the tank is put into use.) Cost of a tank filler hose, fitting, and bottom draw assembly pipe is about \$80.

Small tanks are filled by gravity rather than with pumps. Filling time is about 15 minutes or longer. It is more time consuming than filling with regular pumps at commercial establishments, but it is an effective survival technique.

Solar systems and windmills are a type of prestored energy. Unless these complex and expensive systems are put in place well before their need, they are not practical. Solar cells and windmill power heads have grown in efficiency while decreased in price, but this is of little help to survivors, nurs-

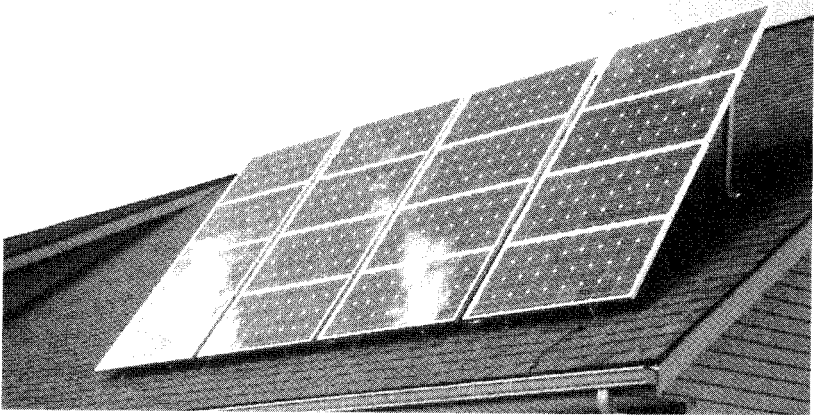

Solar energy is an alternative if you can afford the price.

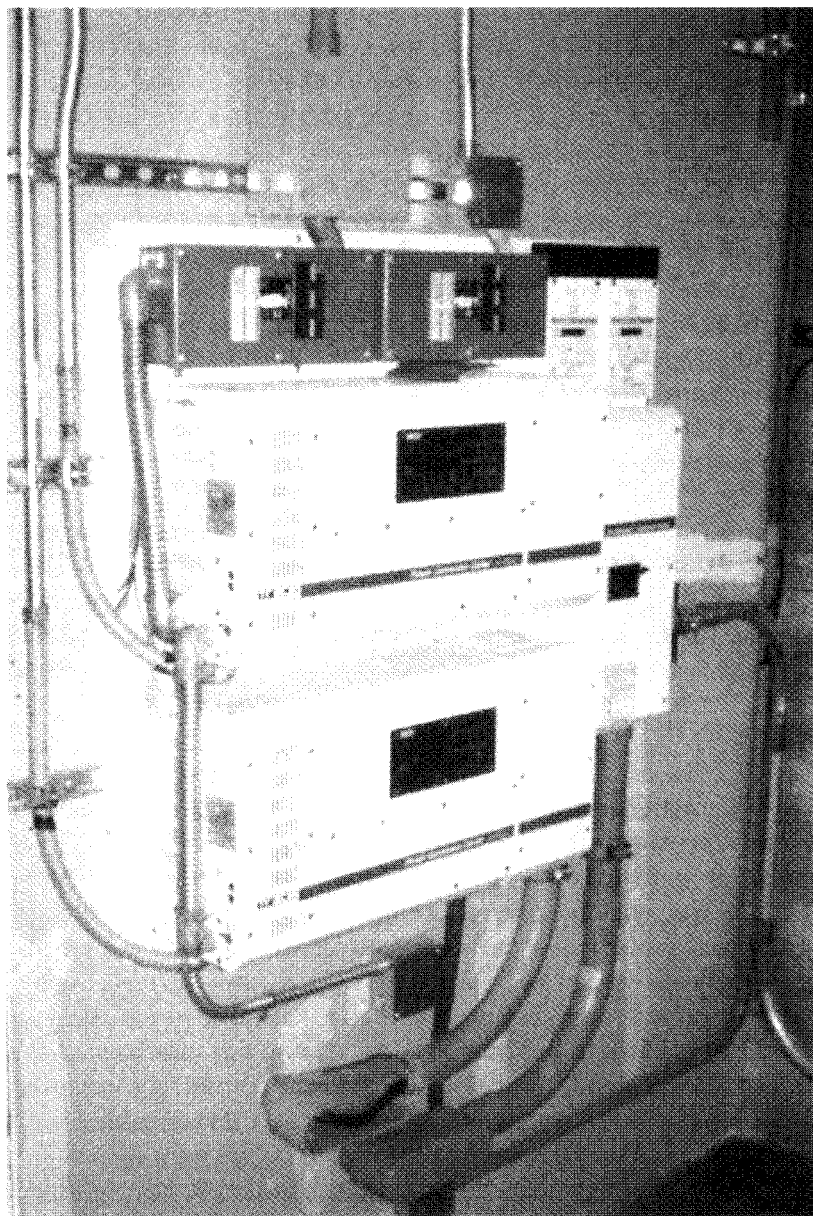

Expensive control boxes are the heart of any solar energy system.

ing or otherwise. Most of the cost of a modern solar or wind-powered system is in fuse boxes, control panels, heavy transmission lines, inverters, and storage batteries. A local survivor, for instance, spent \$6,000 on solar panels and \$59,000 on the remainder of his solar system!

Solar systems are decreasing in complexity and have become easier to work with. In many localities, components are purchased off the shelf and assembled into workable, pre-engineered systems. Nevertheless, solar systems can still be bewildering and expensive. No two seem to be exactly similar.

Readers who wish to pursue this method of energy production and storage should locate as many back copies as possible of *Home Power Magazine* (Box 520, Ashland, OR 97520). The magazine doesn't have as many ads as we might like to see, but it's still the best place to read about places to purchase various wind and solar generators, inverters, batteries, and control panels. After having studied a few back issues of *Home Power Magazine*, most reasonably competent people with sufficient funds will be able to design, purchase, and install a workable solar system.

SCROUNGEABLE ENERGY

This brings us to the second half of the energy equation, which is renewable or scroungeable energy. Examples of unusual sources of energy include the aforementioned home-drying and packing of peat, small-scale coal mining, geothermal development, and perhaps even small low-head hydro. But generally it's going to be a fire, which means burning wood. This wood will probably consist of logs from the forest, old railroad ties, pallets (takes one per day to keep her quarters warm, one nurse reports), pieces of burned-out buildings, or other refuse and trash. I once tried to fuel a small steam engine with wheat straw. Worked okay, but it was very labor intensive.

Using scrap can be a problematic kettle of fish. In cities, charred pieces of building may be used as fuel, but be wary of chemically treated materials that can fill an interior space with



Scrap wood can be scrounged and burned at the retreat.

toxic fumes. Another popular form of scrap, railroad ties, cannot be safely cut into usable chunks by any mechanical means. There's too much danger of hitting a stone, nail, or screw and ruining the blade, chain, or even the engine or its user. As a result, gathering burnable ties and reducing them to usable pieces soon consumes as much time and energy as simply cutting firewood in the first place. (Some ties, with their oil/chemical coating, may present the same fume problem as other pieces of treated wood, making them unusable for anything but an outdoor heating fire.)

Because firewood will likely be a primary source of energy generation, nurses should understand two basic facts about it:

- Not all firewood is created equal. Some tree species contain less than half as much heat energy as other species.
- Green wood must be cut, split, and dried (seasoned) for at least 12 months before it can be burned for energy at a retreat.

Splitting wood is a bit of an art, especially when handling knurled, knotty old pieces that are tough to split but burn marvelously well, throwing out lots of heat. Wood is split

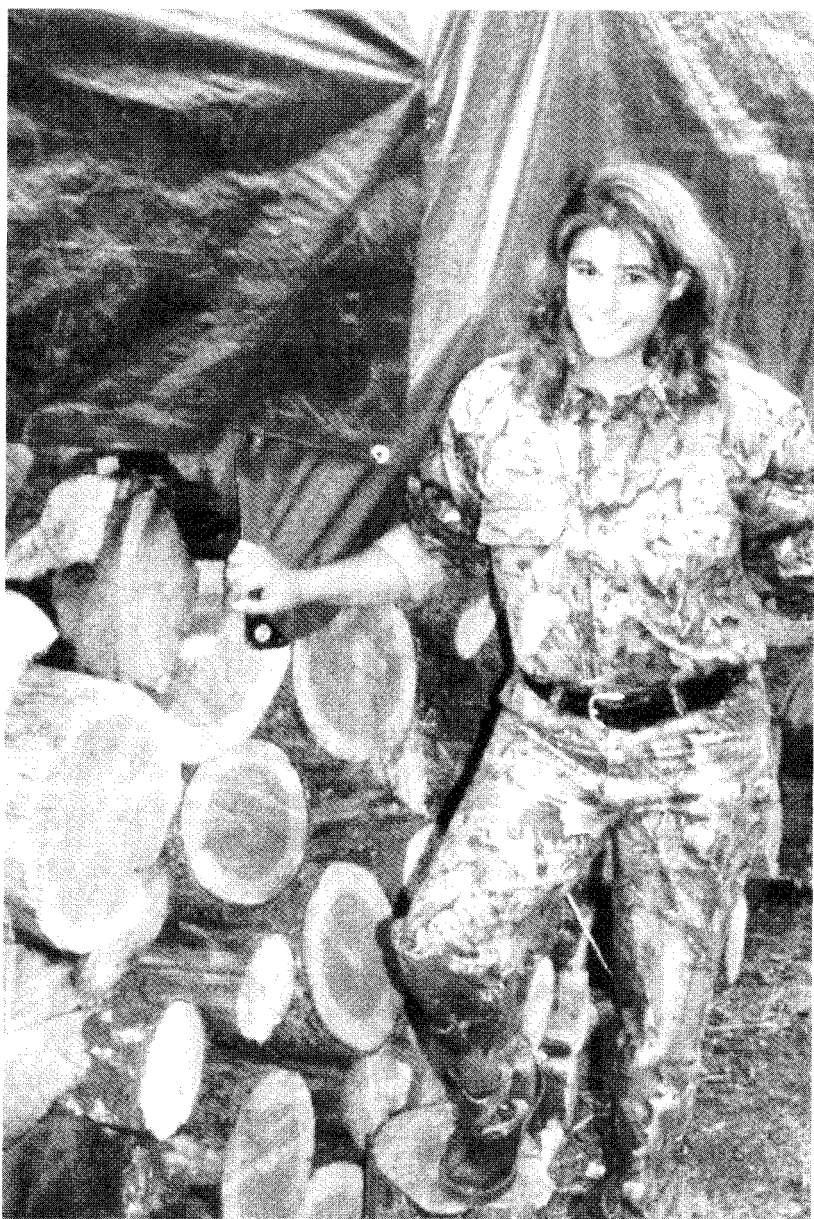

A nice pile of tarped firewood is money in the bank for survival nurses.

Table for estimating cords per tree *

DBH **	Cords/tree	Number trees to make a cord
4	0.01	67.00
6	0.04	23.00
8	0.09	10.50
10	0.17	5.80
12	0.28	3.50
14	0.41	2.40
16	0.58	1.70
18	0.70	1.30
20	1.00	1.00
22	1.20	0.82
24	1.50	0.67
26	1.80	0.54
28	2.20	0.46
30	2.50	0.40

* Source: University of Idaho Agricultural Extension Service

** Diameter outside bark at 4.5 feet above ground level

using a wedge-shaped maul on the end of a 36- to 40-inch handle and a steel splitting wedge. Modern wedges turn in the log as they are driven in, producing a better action.

It's best to purchase a maul and wedge to practice with. Hopefully not too many maul handles will be lost. Properly replacing ax or maul handles is difficult and perhaps beyond the scope of this book, but I'll try anyway.

Cut the handle off as close to the steel head as possible, then throw the head in the fire to burn out pieces of the old handle. Retrieve the head from the fire before it gets real hot. Clean the handle hole out with steel wool.

Using a heavy, raspy file, work down the end of the replacement handle till it slips snugly into the head up to the handle stops. Cut off the top of the new handle a half inch above the top of the steel head. Now drive in as many small handle wedges as possible, spreading the handle end so that it cannot be withdrawn from the head.

Nurses should know how to operate chain saws, if for no

SURVIVAL NURSING

68

Heat Recovery of Various Wood Species compared with Fuel Oil *

Species	Density at 20% Moisture Content in Pounds/cu.ft.	Average Weight of 85 cu.ft. @ 20% moisture content in pounds	Possible Recoverable Heat Units per cord of 85 solid cu.ft. at 100% efficiency and 20% moisture content in millions of BTUs	Available heat per cord at 50% heating efficiency provided by most wood stoves in millions of BTUs	Equivalent gallons of fuel oil @ 60% burning efficiency for oil furnace
Hickory	50.9	4,327	27.7	13.8	70.6
Eastern Ironwood	50.2	4,267	27.3	13.7	69.6
Apple	48.7	4,140	26.5	13.2	67.5
White Oak	47.2	4,012	25.7	12.8	65.4
Sugar Maple	44.2	3,757	24.0	12.0	61.2
Red Oak	44.2	3,757	24.0	12.0	61.2
Beech	44.2	3,757	24.0	12.0	61.2
Yellow Birch	43.4	3,689	23.6	11.8	60.2
White Ash	43.4	3,689	23.6	11.8	60.2
Hackberry	38.2	3,247	20.8	10.4	53.1
Tamarack	38.2	3,247	20.8	10.4	53.1
Paper Birch	37.4	3,179	20.3	10.2	51.8
Red Fir	34.9	3,155	22.3	11.1	56.8
Cherry	36.7	3,120	20.0	10.0	51.0
Elm	35.9	3,052	19.5	9.8	49.7
Black Ash	35.2	2,992	19.1	9.6	48.7
Red (Soft) Maple	34.4	2,924	18.7	9.4	47.7
Box Elder	32.9	2,797	17.9	8.9	45.5
Jack Pine	31.4	2,669	17.1	8.5	43.5
Norway Pine	31.4	2,669	17.1	8.5	43.5
Lodgepole Pine	30.7	2,610	17.5	8.8	44.6
Hemlock	29.2	2,482	15.9	7.9	40.4
Black Spruce	29.2	2,482	15.9	7.9	40.4
Aspen	27.0	2,295	14.7	7.3	37.4
White Pine	26.3	2,236	14.3	7.2	36.5
Balsam Fir	26.3	2,236	14.3	7.2	36.5
Grans Fir	25.4	2,160	16.7	8.4	42.6
Cottonwood	24.8	2,108	13.5	6.7	34.3
Basswood	24.8	2,108	13.5	6.7	34.3
Northern White Cedar	22.5	1,913	12.2	6.1	31.1

* Chart compiled from information provided by the University of Minnesota and the University of Idaho

other reason than to supervise teenagers working with them. Here is basically how to purchase and run one. First, purchase only a heavy-duty professional make and model of saw such as a Stihl made in Germany. Most experts agree that a novice is better off with a used Stihl than any new American-made saw. This is especially true for women, teenagers, or smaller men who cannot afford to jerk their guts out trying to start a heavy, bulky, unreliable saw.

All Stihl models are workable, but larger (heavier) models are better. At a minimum, a size OV28 is preferred for pro-

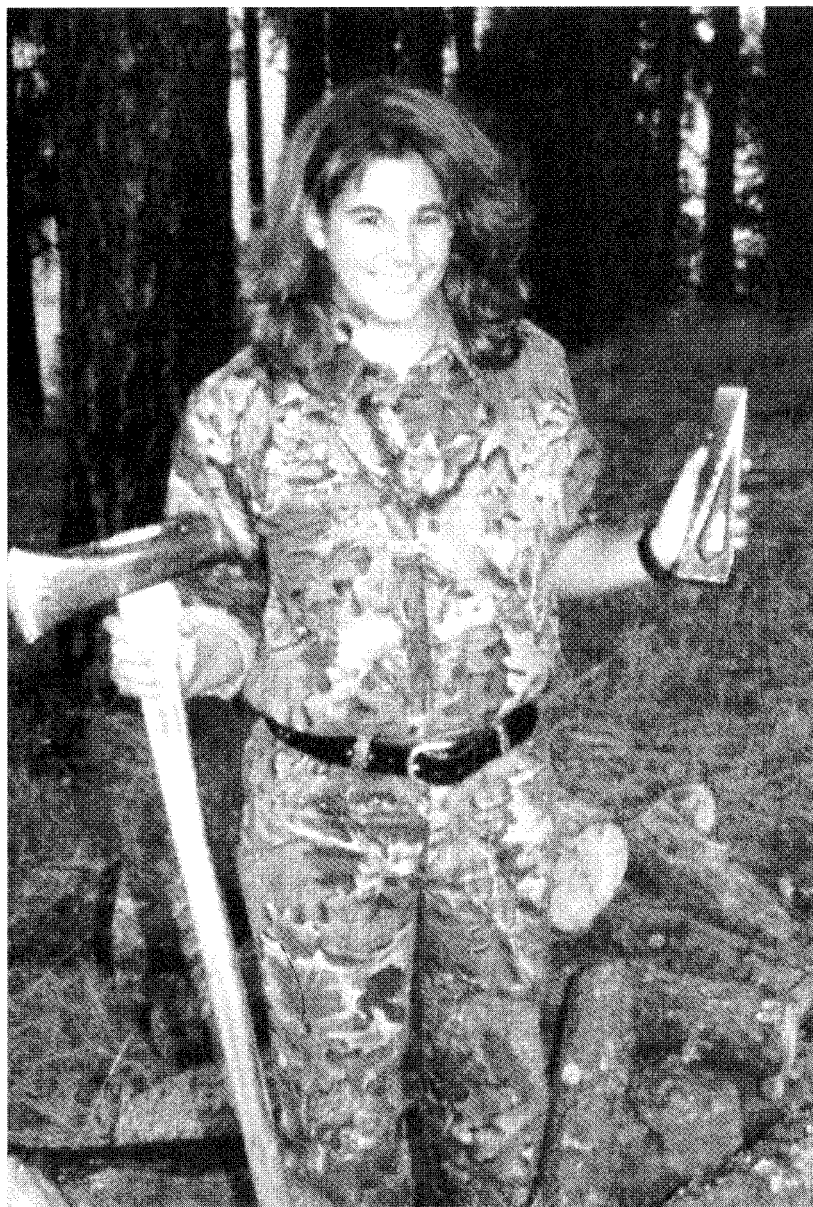

Mallet and modern twisting wedge used to split wood.

SURVIVAL NURSING

70

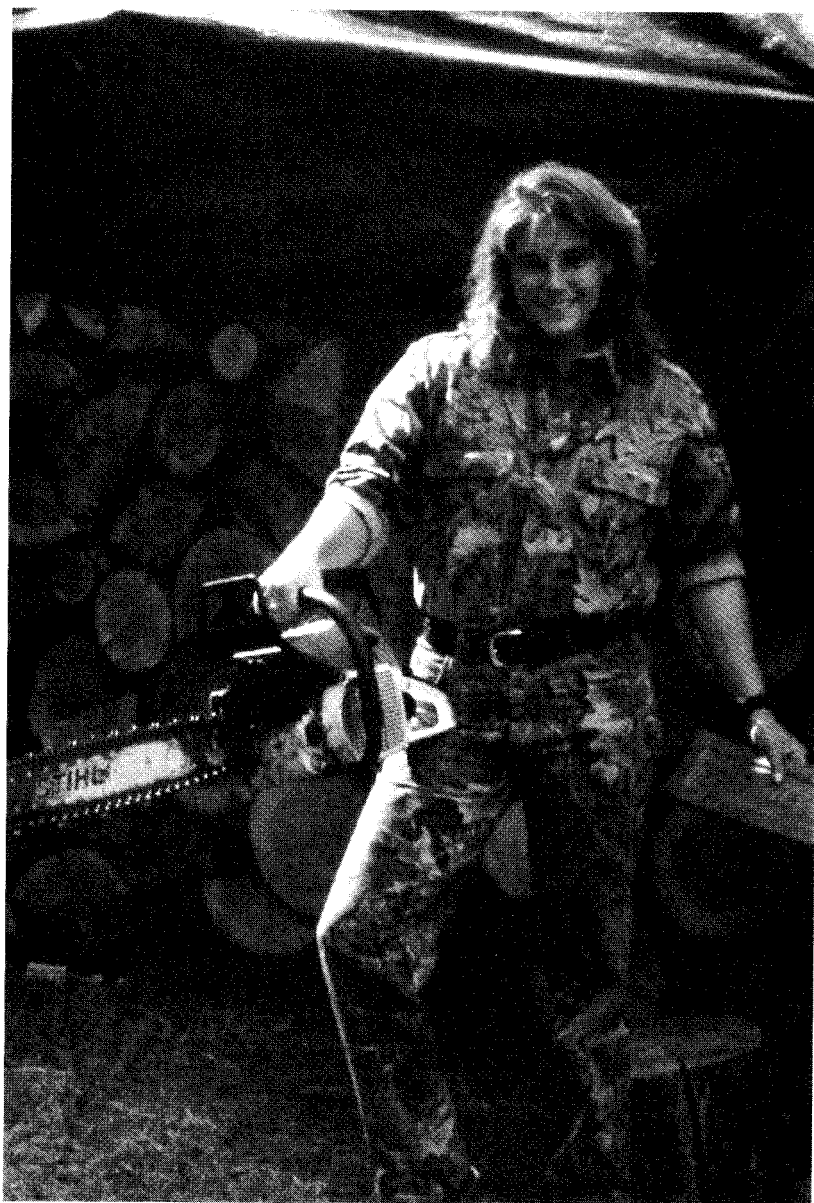

A chain saw and knowledge to use it are invaluable to the true survival nurse. Note that the saw pictured is a Stihl.

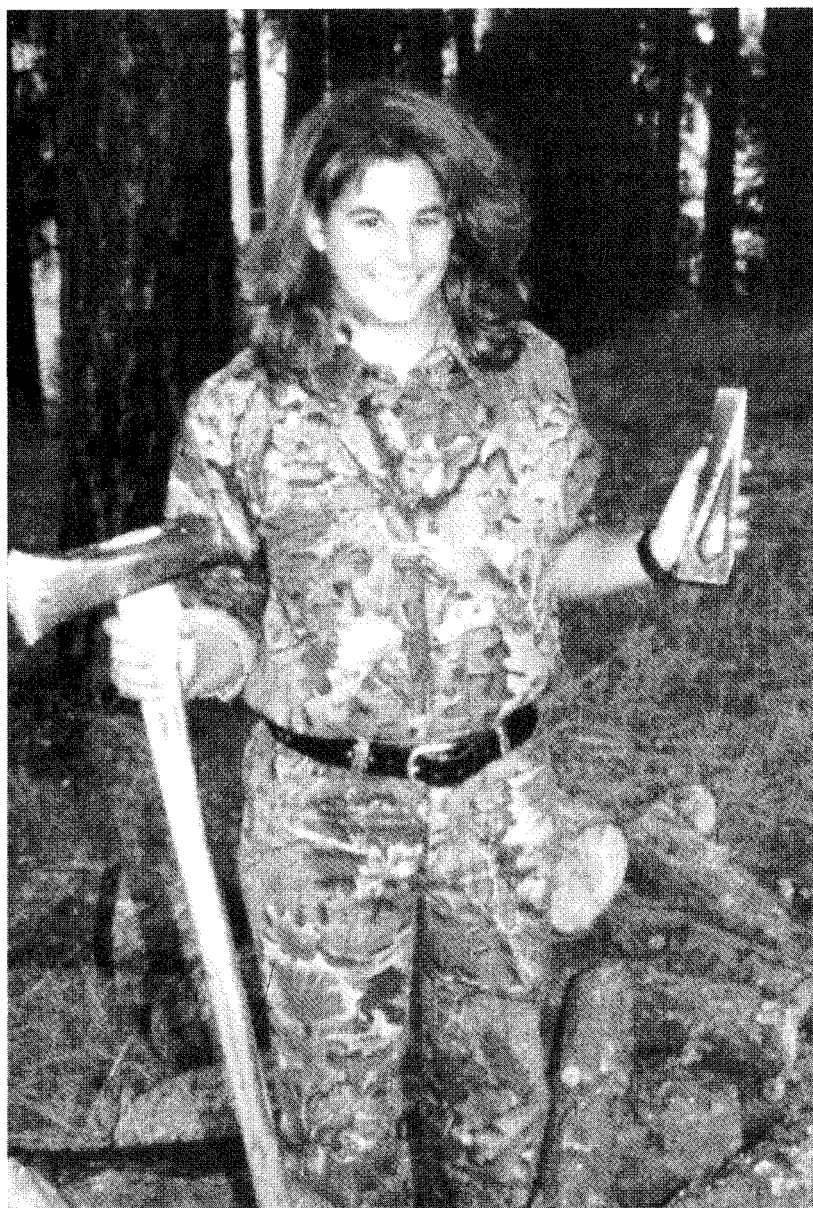

Mall and modern twisting wedge used to split wood.

duction wood cutting. With a 20-inch cutting bar, this is about a 10-pound saw. My wife uses this size and model saw, and she claims it is perfect for ladies.

Survival nurses will have to deal with three maintenance chores on chain saws: fueling and oil, sharpening, and adjusting or replacing worn parts.

The fuel mix for a chain saw consists of a high-quality, two-cycle oil combined with gasoline fuel. The instructions that come with the saw will outline proper proportions. Lubrication is important: keep the lubrication reservoir full of bar oil. No other lubrication is required for two-cycle engines.

When the chain works loose, snug it up a bit by loosening the retainer bolts and adjusting the bar tightening screw. Your dealer can demonstrate how this is done. Otherwise, repairs and maintenance should be minimal. If there are serious problems, take the saw back to the dealer and ask him to show you how to make the necessary repairs. Everything is relatively simple on a good chain saw.

Chain saw chains need resharpener after every tank of fuel. Dealers have the correct size files as well as little stamped

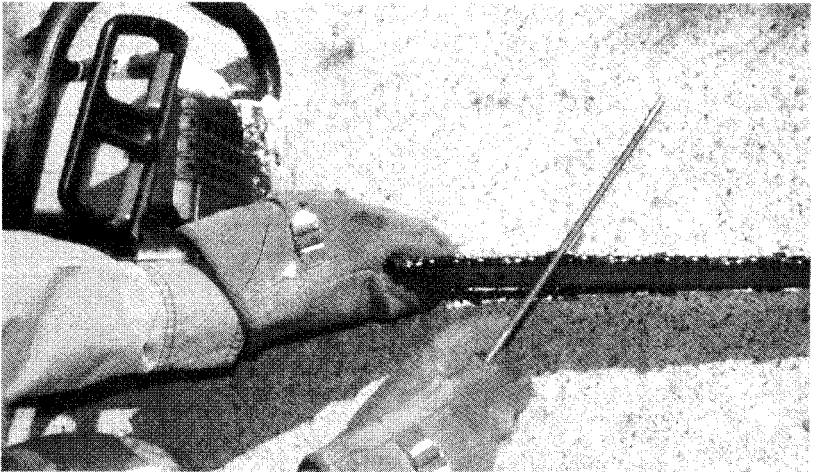

Chain saw chain teeth must be filed one direction toward the outside.

steel guides that help maintain correct depth and angle. Here is a quick chain saw sharpening lesson.

Basically, correctly filing a chain involves always cutting from the inside out—not in both directions, which is a bit more logical but very improper. Sharpen all teeth on one side, filing in one direction only. Then turn the saw around to file teeth on the other side, filing one way only.

Writing about sharpening a chain saw is much easier than actually doing it. Yet no matter how difficult the work, chains must be kept sharp or sawing will be laborious, inefficient, and harmful for the machine and user.

Are there sources of renewable energy with which survival nurses can work other than wood? The short answer is yes but in practice it is really no.

Burning old tires is an often-cited alternative. Theoretically they can be burned in standard wood stoves, and they are common as well as inexpensive. For years and years we heated our farm shop with old tires. What a mess!

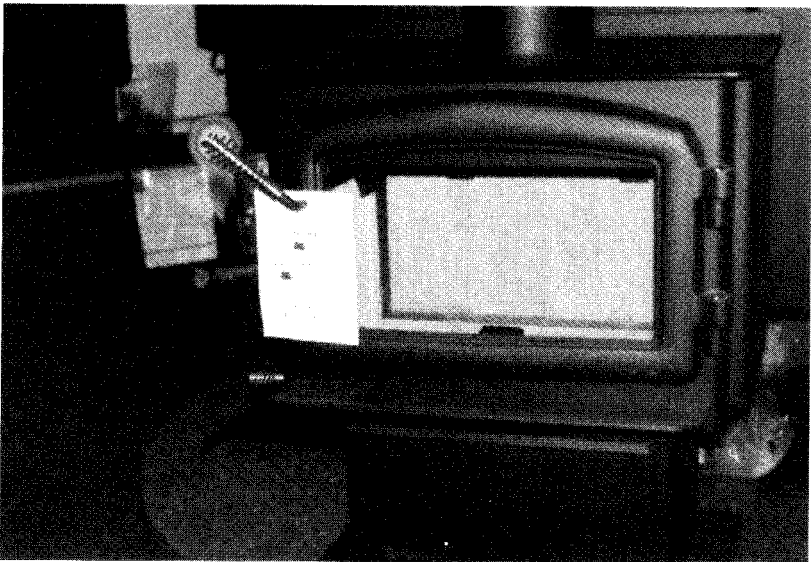

There must be provision for using alternative energy at the retreat, such as this small iron stove.

They were very tough to cut into usable pieces, and the chimney had to be brushed out twice a month. Soot blackened the barn lot downwind of the chimney. My recommendation? Try not to use tires except to start another fire.

Some survivors in central and eastern Idaho, western Wyoming, and southern Montana are sitting on property with good geothermal potential. Cabins, swimming pools, greenhouses, and the like can be heated nicely from these hot-water wells. Certainly this would be nice if such were available, but I wonder how many average readers can really take advantage of geothermal energy.



In conclusion, be sure energy sources you have selected for your nursing retreat actually match the capabilities at your retreat. In other words, firewood won't run most freezers or generators. If it takes diesel fuel to run a diesel generator, be sure you'll have access to sufficient amounts of diesel fuel.

Survival nurses will have more specific emergency requirements for more energy output than the rest of us. If you plan to engage in survival nursing, advance planning is required. If by some stroke of fate you are suddenly thrown into the business, make long-term plans now for energy supplies required later.

Laundry

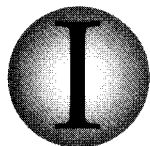

It takes a mountain of laundry to keep a modern hospital functioning. Nurses in these facilities are probably not really aware of the extent to which their patients try to wear out washing machines. Those who actually do the laundry seem dismissive of this chore as they stuff the mouths of huge, industrial-strength laundry machines. And this doesn't even account for the huge numbers of modern hospital garments that are made of cheap paper or cloth throwaways, never destined to see the inside of a washing machine.

Kate Cumming, the Civil War nurse, mentioned that it took about one laundress per 10 patients under her care to handle the laundry chores. Back then everything was done by hand on old-fashioned washboards. (These contraptions are still available today if one knows where to look, but most survival nurses will have too many other things to do without getting involved with washboards!) Even in the

19th century, laundry workers were extremely hard to find, Kate observed in her journal, because nobody wanted to do the back-breaking work, so she hired ex-slaves who were otherwise unemployed.

After a battle, wounded men came in filthy, caked with mud and dirt. Often they had spent months in the field or on the march without relief. These early nurses didn't know much about field sanitation, but they knew the importance of cleanliness, so the first duty of a Civil War nurse was to clean the men. This meant baths for the body and washtubs and mending tables for clothes.

WASHING CLOTHES

Just as with 19th-century nursing, laundry will be a huge problem for modern survival nurses. You cannot allow your charges to wallow in soiled and dirty bedding, and you will not have the luxury of throwing away bedclothes after one or two uses. There is also the matter of washing slings, wrappings, and, to a limited extent, bandages that cannot be summarily disposed of after a use or two. (This is not an ideal situation, but survival nursing will never be done under ideal circumstances.) Nurses will also have to keep their own clothes meticulously clean. This means that after working in the garden, kitchen, or laundry, her clothes will have to go in the hamper and be replaced by clean, newly washed ones before dealing with patients.

Like I said—a mountain of wash. Not to mention post-washing sterilization that must be undertaken by some means or other. Yet survival nurses will not have the luxury of spending hours each day fooling with an old-fashioned ringer washer, nor can they afford to have their teenage worker bees spending all of their time washing clothes, carpets, blankets, draperies, handkerchiefs, paddings, and wrappings when there are so many other vital tasks that need to be accomplished every day.

How many loads can you expect to do per day in a survival nursing situation? Betty Lou was the only one who



Primitive water-heating rack in rural Africa.

could make an informed guesstimation based on past experience. She says plan on about two medium to large loads of wash each day per patient and nurse. Two 55-gallon barrels of hot water can easily handle two full loads of laundry, while 7 1/2 gallons of propane will fire the dryer for about a month.

One could plan to go to a laundromat, which would probably be just about similar in expense and time, but the risks in a survival situation are far too great. One survival nurse said that if she drove 10 miles she could have gone to a rural laundromat at a time of day when she would likely encounter few people. In urban areas, I suppose it would be possible to surreptitiously or unobtrusively use the facilities on a college campus during the summer months or holiday breaks, though obviously this would only be a temporary fix. I suspect the risk and inconvenience outweigh any advantages to using a public facility of any kind.

The answer, then, is to automate to the best extent possible in one's circumstances. Then, within reason, it won't matter how many extra pairs of socks, long underwear, and shirts are thrown in the laundry basket.

A Primitive Laundry Facility

She isn't a trained nurse or an experienced survival nurse, but Mitzi Jean agreed to experiment with laundry in a very primitive setting as a test example for this chapter. She lives in the deep forest, far from civilization as most of us know it. Mitzi has four small children, making this something other than just an idle experiment. (Dealing with four tykes in a backwoods setting also calls into question her claim that she has no experience as a survival nurse!)

First we purchased a relatively small, highly portable, 5000-watt Honda gasoline generator. These small generators are expensive new but have excellent resale value. Mitzi complained long and hard about having to haul in gasoline for this beast, but as it worked out, 5 gallons of gasoline lasted about 2 weeks in full service.

We positioned the generator under the eave of her little trailer's roof in what eventually became an impressive line of appliances. She wanted the generator close at hand in a dry spot where it could be handily maintained.

Next we found and purchased a used, older model of Maytag automatic clothes washer. It was scratched, worn, and stained with rust, but it still ran well. An antique wringer or spin-dry cycle washer might have done as well, but we were experimenting, and saving time was part of the program. This washer went in right next to the generator on the deck.

Obviously the washer required electrical power, which it got from the generator, but it also needed lots of hot water from someplace. Providing water from someplace became quite a challenge.

Gravity ended up playing a major role. Her trailer was up the side of a hill. Everything behind ran downhill to the trailer; everything out front ran downhill and away from the trailer. Her spring, developed with 1 1/2-inch plastic pipe, lay uphill about 300 feet. Tapping into this spring, here is how we provided water for the washing machine.

To heat the water, we built a frame out of heavy 2-inch angle iron on which we could position two 55-gallon steel bar-



Small, portable generator of the type used for an outdoor laundry.

rels side by side. Barrels and frame were set level on a small hillside cut. Eighteen-inch legs got the barrels up high enough to build a fire underneath. The cut in the hill retained and reflected the heat of an open fire.

Fuel under the barrels was composed entirely of old tires and a few sticks of pine. Mitzi cut the old tires in half using a SawsAll hand tool. Half a tire pretty much took the chill off crackling cold spring water. In winter she had to burn a second half-tire to get the water hot enough for medical laundry. It took about 45 minutes to heat the water to a proper temperature.

The tops of the barrels were open to allow filling with water from the spring. But, alas, there wasn't enough elevation from spring to standing barrels to allow for natural filling. To overcome this, we put a spigot in the pipe from the spring, allowing us to fill 5-gallon pails one at a time. Then it took lots of hard work to dump pails of water into the barrels. It took about 15 minutes to hoist 22 buckets of water to fill the empty barrels.

To protect our plastic pipe from heat damage, we fastened 6 feet of 3/4-inch iron pipe to the bottom of the barrels. All we did was screw the pipe on a street L plumbing fitting into the

small bung on the bottom of the barrel. At the end we placed a T and a shutoff valve that connected directly into garden hose running to the wash machine. I questioned the durability of garden hose for carrying hot water, but we used high-grade hose, which lasted almost a year. It was another 40-foot run over a drop of about 6 feet down to the washer.

As it turned out, this carefully cobbled contraption provided enough hot water to run her automatic clothes washer. She washed once every other day. The barrels and, to a limited extent, the surrounding hillside soon became black and soot laden, and theoretically someone looking for her or the kids could have zeroed in on the heating water, both potential problems in a desperate survival situation. Yet as far as our experiment went, it was a nice, workable, relatively easy but temporary 8- or 10-month substitute for the real thing out where no one would suspect a survival nursing shelter.

People in rural areas where mild climates prevail often put together setups like the one above. The difference in cold, nasty climates is that all pipes must be drained of water or they will freeze and burst, and you may have to start in the morning with ice in the hot-water barrels.

DRYING CLOTHES

Washing clothes in hot water wasn't the end of it. Mitzi found that hanging clothes on a line was fine in summer but of little help in cold, rainy, or snowy weather. Besides, we were unsure how sterile these clothes really were when she was all done. As a result, she eventually put in a clothes dryer and ironed everything afterward, including socks and underwear. In a true pioneer nursing situation, as she calls it, she believes that two clothes autoclaves—an apparatus that uses superheated steam under pressure for sterilization—would be necessary for patients and staff living amongst mud and dirt. (More on autoclaves later in this chapter.)

Power for the dryer came from the generator, which handily ran both washer and dryer as well as a few lights. It was an

LP gas clothes dryer, gas for which came from a 7.5-gallon propane bottle. She vented exhaust and lint from the dryer off into the forest.

Compared to hanging sheets and pants on a line, a clothes dryer is a very low-profile device, Mitzi observes. Those concerned about others knowing that there are extra guests by looking at clothes on the line should seriously consider an LP gas clothes dryer, which can be set up virtually anyplace. All of this stuff could have been operated under a big cedar tree in the front yard, according to Mitzi.

DETERGENTS

Even compared with laundry detergents from 5 or 6 years ago, modern detergents are a miracle. They seek out and attack dirt and grime in a miraculous fashion. They are also easy on the environment, especially if you get the biodegradable variety. Mitzi ran her washer waste water via 80 feet of 1 1/4-inch black plastic pipe out on the garden as a kind of automatic irrigation/fertilization practice.

Survival nurses will have to lay in large quantities of laundry detergent for the hour of need. How much? About double again what would have been consumed in a normal year. Thankfully, detergent now comes to market in sturdy plastic buckets that keep forever.

STERILIZING CLOTHES

Autoclaving laundry is not necessary outside a true survival nursing situation. Autoclaving is used for dressings, bandages, and perhaps bed garments and underwear and for especially grim circumstances when vermin have invaded the sick bay. We don't know where our patients will come from, what horrible indignities they may have suffered, nor what free riders they may bring along with them. Lice and fleas can run off with the joint if you are not vigilant. Better to prepare to deal with them.



Survival nurses will require great quantities of laundry detergent.



Stacking a clothes autoclave for immediate use.

Clothing can be steam purified in a regular canning-type pressure cooker by using a big kettle or by making an autoclave out of half a 55-gallon steel barrel. In either case, place a couple of small stones or a brick or two in the bottom of the container and set a piece of expanded steel or other wire rack on these spacers. These act as a buffer, holding items to be sterilized up off the bottom of the pot.

Depending on the size of the pot, place one or two cups of filtered water in the bottom of the container. Drape items to be sterilized (e.g., bandages, slings, dressings, towels) on top of the rack. Fill it only to half or slightly more than half. It may be necessary to place plastic spacers in heavy clothing to keep them spread out a bit. Short lengths of scrap plastic pipe work nicely.

Place a fairly tight lid on the container. The lid raises internal pressures a bit, ensuring that 212°F+ steam permeates everything inside. Heat the water slowly and gently so as not to waste fuel. We don't want quick action in this case, which often results in scorched contents.

As soon as the steam stops, take the autoclave off the heat source and let everything sit at least 1 hour. Anything still damp will quickly dry upon exposure to fresh air. Either place items in sealed bags for later use or use immediately.



Use of mechanical laundry facilities is obviously not pure survival. The question always must be, what are we trying to accomplish? If it's to keep a patient clean, neat, and comfortable, we are virtually forced to use some sort of mechanical help. The back-breaking load of work notwithstanding, most of us don't know how to wash clothes on a rock in a river or on a washboard. Even if we did, is it really wise to forgo the efficiency of modern laundry detergents? Laying back an adequate supply of laundry detergent adds yet another layer of preparedness not unlike the entire concept of survival nursing in general.

Supplies

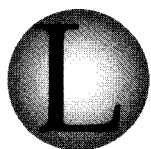

Locating, procuring, and storing necessary supplies will be one of the greatest challenges facing survival nurses. There are literally thousands of different medications and medical-related supplies that we could and perhaps should have in our shelters and on our shelves.

Obviously some of you won't be able to find many of these supplies. In cases where you do succeed with your search, you still might not be able to afford to stock the full spectrum on your shelves, or you may have to make do with a less-easy-to-clean wood table rather than the preferred stainless steel equivalent.

To a certain extent, determining which supplies to work at finding is a personal matter. I, for example, completely ignore drugs related to epilepsy even though this is a life-threatening condition for many. We don't have experience with epilepsy, so the condition is forgotten. Certainly there are

dozens of other examples of specific medical problems we might have to face but which must be glossed over in this general approach.

All I can do in this chapter is make recommendations based on what most people would do. Nevertheless, not everyone will be thrilled with this list. But let's let past experience be a guide to what we currently might wish to keep on hand.

DISINFECTANTS

As emphasized in Chapter 7, disinfectant concentrates will be used in every survival nursing situation. Within reason, one or two products will work for every situation.

Nolvasan/Chlorosan, made by the Fort Dodge Company, is the first disinfectant concentrate to consider. Use 3 liquid ounces per gallon of clean water to handle all bacteria and most viruses. This material is ideal for butchering areas as long as the residue is washed away after treatment. It is commonly available from animal health stores or by mail order.



An assortment of fungicides, disinfectants, and wound dressings purchased at the local agricultural supply store.

Kenic Parvo-Lan-128, made by the Glo-Marr, is used on the basis of only 1 liquid ounce per gallon of wash water. This product is even effective against HIV-1 (AIDS virus) as well as most common fungi, bacteria, and other viruses. It is also a common animal health product.

Both of these disinfectants store well in the medium to long term (7 to 10 years).

Nolvasan/Chlorosan and Kenic Parvo-Lan-128 are used to disinfect physical premises, not patients. Betadine and chlorhexidine are used to clean up and disinfect people. They can be purchased in quart or gallon jugs at the veterinarian's counter. It's identical to the stuff hospitals use but at about one-third the cost. Betadine contains iodine solution and is probably the more commonly recognized of the two. (Be aware, however, that there are two types of Betadine—one to wash wounds and another to disinfect walls and floors. Only the first type is available through veterinarian supply outlets.)

Vet-grade hydrogen peroxide is another strong wound cleanser available from most full-service vet supply counters. A weaker, more expensive version is available from drug-stores. Hydrogen peroxide has a very limited shelf life but is invaluable for cleaning poorly managed, infected wounds, provided your patient can withstand the pain. Because of its limited shelf life, most animal health stores may have to special order for you.

CRITTER CONTROL

Ticks and lice are easily controlled with a selection of vet-grade products. Some brandname remedies include Taktic by Hoechst Co. and Permethrin II by Anchor. Read labels and then dilute these concoctions to concentrations recommended for small pigs. Shelf life is 10 years or more. Horse people are especially fond of these materials, so look for the products wherever people purchase supplies for their horses.

Rats and mice will become a problem for any long-term survival nursing station. This is not a good situation in areas

where native mice carry the dreaded hantavirus. Because of this and other diseases these critters carry and because of spoilage of supplies, it will be necessary to take strong action against them.

Only in the past 10 years have baits become both sufficiently palatable and lethal to make eradication possible. Your friendly vet supply outlet will have dozens of different baits. Read the labels to locate those containing a material named bromadiolone. Difethialone is another modern rodent killer that produces spectacular results. Even world-wise farm cats do not provide the same levels of protection against mice.

MEDICATIONS

Not to recover old ground, but as detailed at great length in my book *Do-It-Yourself Medicine*, there are five major sources of medications available to survival nurses. Be aware, however, that we have no idea how rapidly these stocks will evaporate from the scene during an emergency. Be that as it may, these five sources are:

1. Obtaining it from professionals who have access to medications, pharmaceuticals, and medical supplies (perhaps on the black market). This group might include medical technicians, veterinarians, hospital interns, and dental assistants. Historically this has been the most common method of supply in collapsed economies.
2. Bringing it in from foreign countries, either by mail order or in person, where they are more easily available and less expensive.
3. Using medications purchased off the shelf from veterinarian supply or animal health centers. Many, many common pharmaceuticals are used by veterinarians to treat pigs, horses, cattle, chickens, and dogs. All of these are easily available without question to survival nurses and are safe as well as effective for humans when used properly.
4. Obtaining it via counterfeit prescriptions produced on a



Examples of creative procurement of valuable items for survival nurses. The Imodium is off the shelf in the United States. The Treda compound is a Mexican product similar to Imodium. Bag Balm is available off the shelf at agricultural stores, and both Flagyl and Tetracyclina are available in Mexican pharmacies.

- computer with a color scanner. This technique is far easier than one might suppose so long as absolutely no narcotic drugs are involved. Prescription blanks are sometimes simply run through a photocopier and then refilled!
5. Overbuying on current prescriptions. In this case, a survival nurse purchases all of the refills available on a current prescription. In some cases she might be able to sweet-talk or con pharmacists into providing additional supplies of drugs she knows or suspects will be needed for future use.

Storage for the following array of goods need not be complex. Some preparations and medications such as antibiotics are obviously best kept in the refrigerator. We keep all powders and pills, except those that warn otherwise, in the freezer. Jugs of this and that, including disinfectants, are stored in sealed plastic buckets, as is our medical hardware. These buckets are then stored in a well-insulated, climate-controlled room.

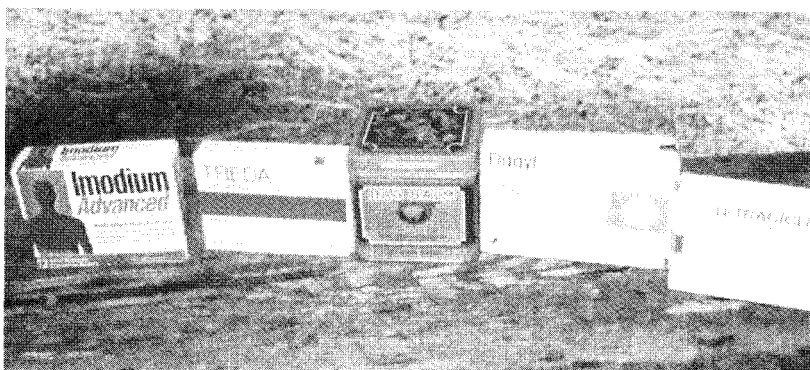

Agricultural supply shelves have hundreds of medications and items of equipment of practical use to survival nurses.

Painkillers

Narcotic drugs are very tough for nonprofessional survival nurses to acquire. Tylenol 3s are probably the best, most universally available of these. Canadian 222 pills with reduced codeine content keeps them from actually being Tylenol 3 equivalents, but they are still reasonably effective painkillers. Any adult in Canada can purchase 222s over the counter, and transporting them back to the United States is not a problem.

Topical painkillers are useful when infected wounds must be cleaned, more stitches installed, or an old wound gives grief. There is a vet product called Allercaine spray that contains 2.5 percent lidocaine, or you can use high-powered but common hemorrhoid medications that contain 2.0 percent or more lidocaine and are available over the counter at most drugstores and supermarkets. Read the label to be sure it contains at least 2.0 percent lidocaine.

Lidocaine by itself or mixed in preparations has poor shelf life—figure 2 years maximum. That's why some off-the-shelf topical pain compounds are more effective than others. Also, consider the often overlooked fact that some tubes may have sat in inventory for months while others may be fresh from the factory.

SUPPLIES
91

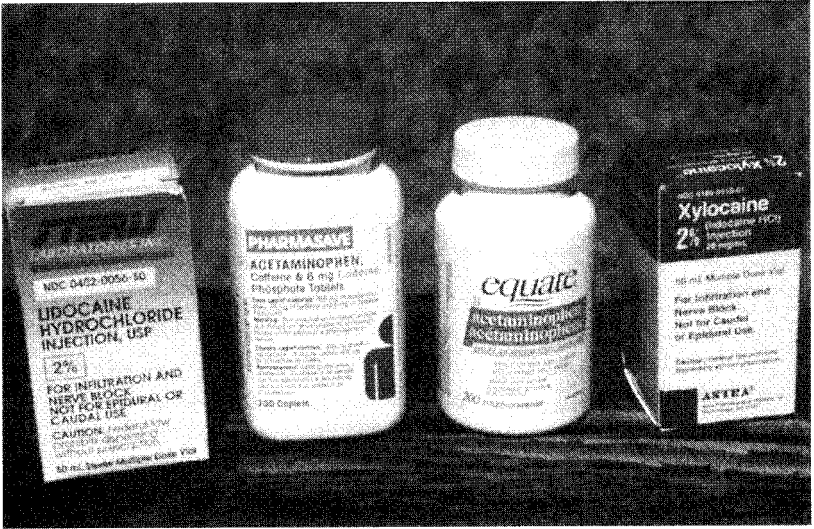

Off-the-shelf painkillers. Lidocaine in two different brands available off the shelf in Puerto Rico, and Canadian .222s, similar to Tylenol 3s in the center.

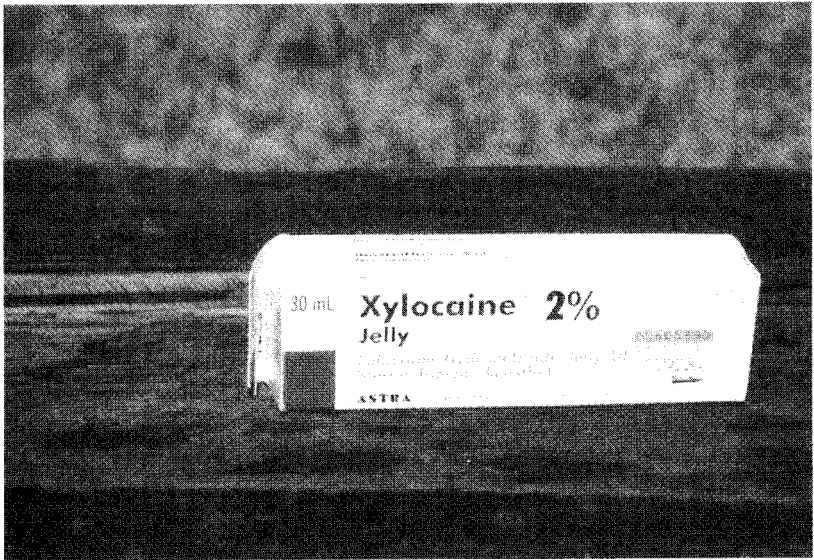

Off-the-shelf hemorrhoid medication with 2 percent lidocaine useful for sewing wounds.

Injectable lidocaine would be a nice addition to any medical inventory. Extraction of teeth is very difficult without it or its equivalent, for instance. Unfortunately this product is not commonly available in the United States, either by prescription or over the counter, and animal health centers do not carry it.

Injectable lidocaine *is* available over the counter without prescription in Puerto Rico and Mexico. Purchase is not straightforward, however: in my experience, only a very few pharmacies in Puerto Rico carry it. Ask around till you find a pharmacy that both has the material and will sell it. In some areas in Mexico, a small bribe may need to be paid. In any case, ask the druggist to secure a new supply from his wholesaler unless you are sure the bottle in front of you is no more than 2 years old.

The next material is unusual in that it is secured from chemical supply warehouses rather than medical-related outlets. The question is, will survival nurses require chloroform with which to anesthetize their patients? If your answer is yes, secure a couple of pints from the folks who advertise chemicals in publications like *Shotgun News* and *Mechanics Illustrated*. Shelf life of chloroform is 3 years at best, and then only if it is kept in double-sealed containers

Drugs for Specific Ailments

In a few notable cases, essential pharmaceuticals are becoming easier to acquire. Zantac, for example, was once available only by prescription in spite of the fact that it is a benign drug that no one abuses. It is now available in relatively limited 75mg doses over the counter in drugstores and supermarkets. Survival nurses can use it to settle stomachs irritated by harsh drugs such as tetracycline. Shelf life is about 5 years.

Giardia may be a problem for survival nurses who may be forced to consume or give their patients less-than-ideal water. Flagyl tablets taken with substantial doses of tetracycline will help cure this ailment. Tetracycline is available at the local vet counter as Terramycin; Flagyl is available over the counter in Mexico. Flagyl tablets have a shelf life of about 4 years, while

tetracycline begins to degrade dangerously after only 2 years on the shelf.

Other important antibiotics are available at full-service vet supply stores. These include amoxycillin, penicillin, neomycin sulfate, and Combiotic, a broad-spectrum combination effective against many bacterial infections. Agricultural-grade Combiotic was our drug of choice to fight venereal disease in rural Africa.

Antibiotics should be stored in the refrigerator. Even refrigerated, shelf life is only about 5 years. Unlike tetracycline, other antibiotics simply weaken till the materials are no longer effective, no matter what the dosage level.

Dysentery and general diarrhea will be a cause of concern for all survival nurses. Probably diarrhea will be the single biggest cause of patient loss. Kate Cumming reported that her fellow nurses often caught something from their patients that caused diarrhea, ultimately leading to the death of both nurse and patient!

Several medications for diarrhea are available over the counter in the United States. But before starting in with any treatment, it is important to determine the cause. This may not be easy. Is it the water? The rough, poorly cooked food? The medications the patient is taking? If the diarrhea is accompanied by blood and mucous in the stool, it is upgraded to dysentery status. Dysentery is definitely *not* simple diarrhea.

There is now a product available over the counter in Mexico called Treda that is composed of kaolin (common clay), pectin, and neomycin antibiotic. Shelf life is reportedly 3 1/2 to 4 years. In the United States we now have a remarkable over-the-counter drug called loperamide HCl/simethicone (trade name Imodium). Both are excellent diarrhea treatments.

Without getting into complex issues regarding the treatment of diarrhea, let it be pointed out that in most survival situations, this common ailment can be successfully treated with lots of clean drinking water and a very high-protein diet. It may be wise to stock shelves with dehydrated high-protein dietary supplements.

In the event of very serious diarrhea with attending dramatic loss of body fluids, veterinarian counters sell electrolyte solutions containing 5 percent dextrose that can be used to rehydrate patients. Administered at the rate of 2ml per pound of body weight, it should be viewed as a serious last-ditch measure for severely dehydrated patients. The shelf life of this material is reportedly rather brief, only 6 months or so.

Gold Bond Powder is wonderful for treating bedsores, with which many survival nurses will have to contend. It works as well as many prescription products but is commonly available over the counter or by special order from American pharmacies. It stores very well—10 years is no problem.

Internal parasites may be a problem in survival situations, but again, a great number of ag products are available to treat such conditions. Piperazine comes to mind. A colorless, tasteless, odorless liquid, it is the same stuff medical doctors prescribe for humans. Shelf life, as far as I know, is at least 10 years. Agri-Labs is the principal manufacturer.

Injectable epinephrine, available at vet counters, is used in reduced doses to treat anaphylactic shock brought on by allergic reaction to other injected pharmaceuticals. It isn't often deployed, as we will seldom encounter allergic reactions to drugs we inject. But epinephrine, like a fire extinguisher, should be kept on hand at all times just in case.

A large portion of survival nursing will certainly entail treating wounds, and there are a good number of vet products with almost magical healing qualities. Start with a product called Kwik-Stop, billed as kind of a chemical hemostat against bleeding. Also consider Scarlet Oil, Bag Balm, Nolvasan ointment, Wound Aid, and Thuja zinc oxide. Any pinkeye medication will heal wounds miraculously. Shelf life for these products is not known but is assumed to be quite long.

Patients living under dirty survival conditions commonly encounter eye problems, so ask your vet supply person about a product called chloromycetin. This is one of the new miracle drugs for eyes, but beware of overuse or for purposes other than treating eyes, because other problems can result. Read the

label carefully. Veterinary concentrations are high, requiring dilution before use on people. Shelf life is probably 2 to 3 years.

Fungal diseases like athletes' foot, jock itch, and impetigo may show up on less-than-squeaky-clean patients. Fungisan, a veterinary product, is perfect for these maladies. Shelf life is about 5 years.

Most people these days are vaccinated against tetanus, yet the wounds they are likely to receive in a survival or paramilitary context will test this inoculation. Vet-grade tetanus antitoxin will treat it, while tetanus toxoid will reinoculate those at risk who cannot recall their last shot.

Obviously, a good supply of vitamins will come in handy to help supplement a patient's nutritional requirements not being served by sometimes meager or intermittent survival food supplies. Fortunately, there are great numbers of oral and injectable vitamins available at animal health counters. They are very concentrated and should be diluted heavily for human consumption. Use recommended doses for 100-pound hogs. Their shelf life is 6 to 8 years.

As a final note, consider pharmaceuticals as good trading stock. Some, like Viagra, are pure bartering items. You may consider stocking this drug to trade for some other drug or item not in your inventory when needed. Viagra is freely sold

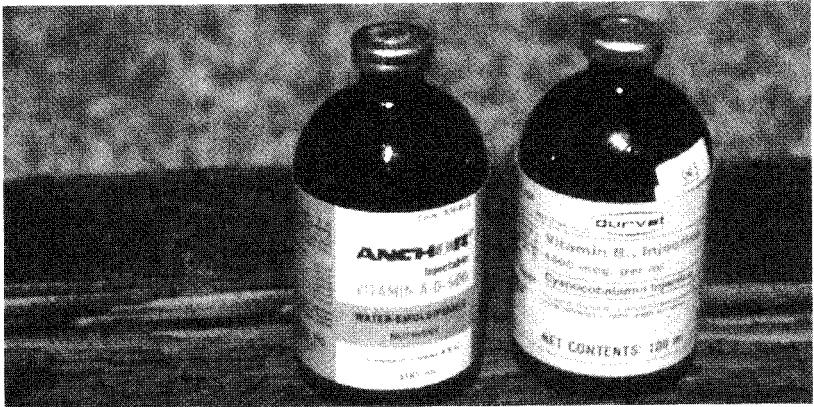

Vet-grade, high-potency vitamins.

over the counter in Mexico, or it can be secured in this country using a counterfeit prescription. Vitamins are also excellent bartering items. During the war in Afghanistan in the 1980s, muzahaddin guerrillas attributed almost magical qualities to Western vitamins, carefully extending their precious supplies by ingesting them at multiday rather than daily intervals.

THE BIG STUFF

A major category of items required by survival nurses is pieces of equipment. These include medical instruments and such materials as syringes and suture material, larger accessories such as bedpans and trays, and furniture and its accompaniments (e.g., cots, bedding).

The following is hardly an exhaustive list but should simply serve to generate ideas of the scope of acquisition and scrounging you will need to do to equip a survival nursing station.

Medical Instruments and Materials

Unfortunately, not all of the following items will be available at all animal health centers. Some stores will special order for you, or try Jeffers, Inc., Box 948, West Plains, MO 65775. Jeffers has almost all these materials in its mail order category. Those within driving distance of West Plains, Missouri, might consider pooling a large order with friends and buying in person at the Jeffers retail store. Of course, where you heard about Jeffers and intended use of these materials is best kept private.

Again, this is not an all-inclusive list. Doctors themselves differ dramatically over what materials they use for which purpose and what they like to keep in inventory. The following list is basically what we have decided to keep in inventory after thinking about the matter for more than 25 years.

Regretfully, I cannot provide a cost estimate for all of this: I secured most of these materials over a period of years. Some vet supplies are decreasing in price while other, newer materials are shooting up out of sight.

SUPPLIES

97

That said, here is my list of equipment:

- 2 small forceps, which also double as hemostats
- 2 medium straight forceps
- 2 medium curved forceps
- 2 needle holders
- 5 packages of Dexon II suture material, size 0 for use with smaller needles
- 5 number 18 3/8-inch-circle surgical needles
- 10 number 20 3/8-inch-circle surgical needles
- 2 surgical blade handles
- 10 style 12 surgical blades
- 10 style 10 surgical blades
- 2 pairs surgical scissors
- 30 disposable syringe and needle combinations, 22 gauge x 1 1/2-inch needle, 3ml capacity
- 30 disposable syringe and needle combinations, 22 gauge x 1 1/2-inch needle, 12ml capacity
- 1 to 10 ml capacity chrome reusable syringe
- 100 stainless steel needles, 22 gauge x 1 1/2 inch
- 3 double-pointed transfer needles
- 4 large sterilized packets of bandage material
- 2 vet-grade digital thermometers

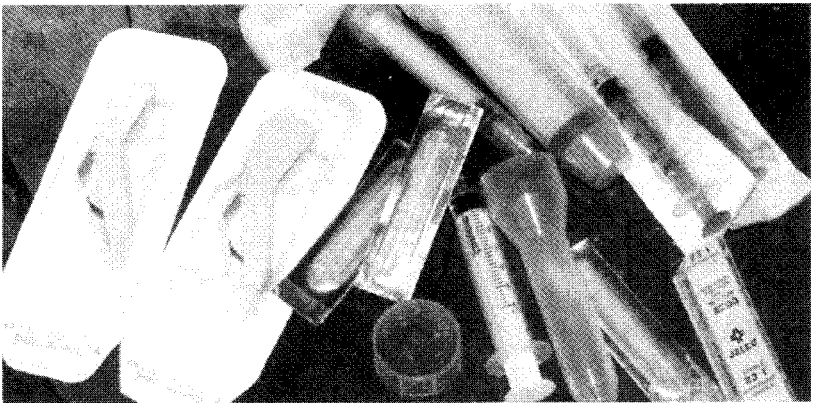

Sutures, staples, syringes, and needles, all available from your local vet supply store.

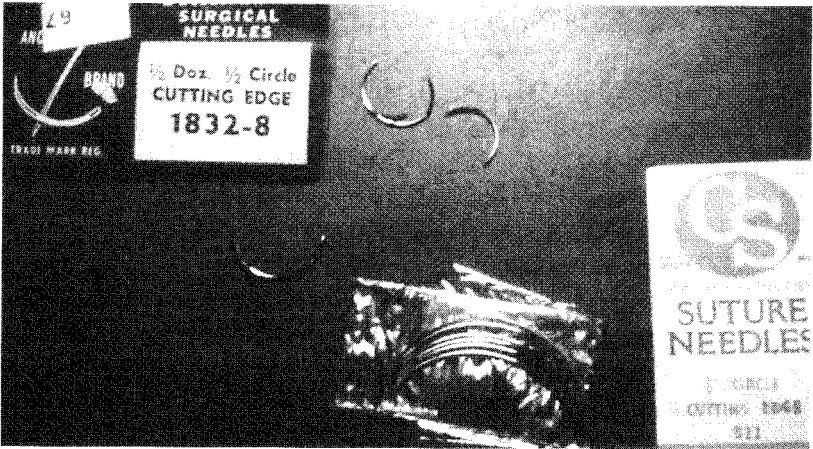

Ag-grade suture needles.

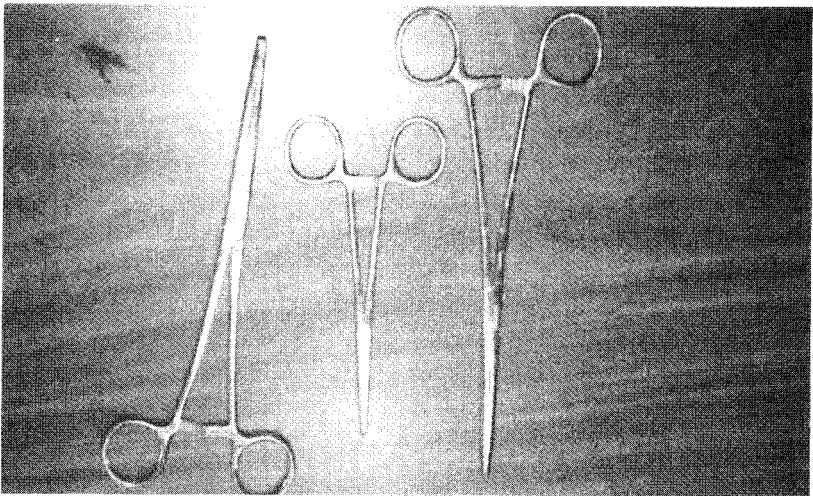

Three hemostats purchased from the local ag supply store.

- 5 boxes (200 each) alcohol preps
- 3 large packages adhesive tape (vet grade is less expensive)
- 10 packages veterinary elastic adhesive bandages
- 5 boxes sterile surgical gloves

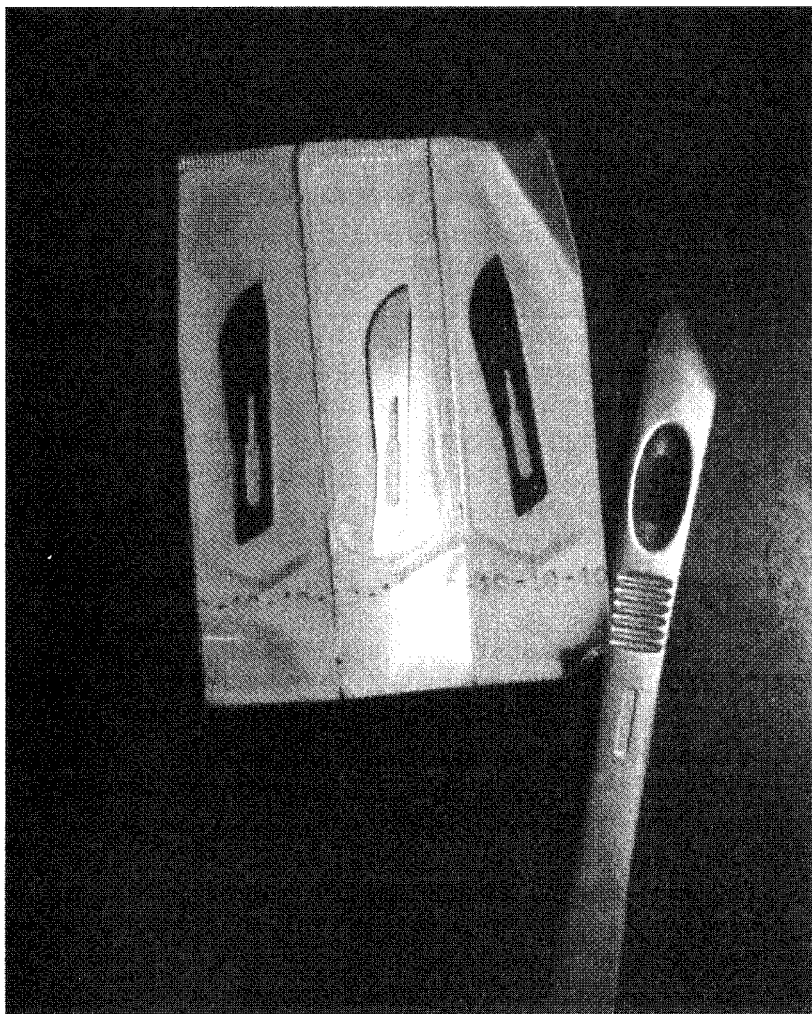

Ag-grade scalpel handle and blades.

Shelter Furniture and Equipment

The following items can be purchased from the usual outlets—discount department stores, camping supply shops, and military surplus outlets. I have purposely avoided discussing specific quantities of supplies in this section because much

will depend upon the conditions at your locations (windy spots will require more straps and guy lines to fasten down tents and tarps, for example), the climate (colder areas will need more and/or better blankets, wet areas more rain protection), the number of patients you think you will be handling, and so forth. Just keep in mind one important point—the nursing area itself should remain as uncluttered as possible for ease of cleaning and to maintain a comfortable working and convalescing space.

- Beds/cots—As opposed to ground pads or their equivalent, beds or folding cots make nursing a bit easier. Care givers don't have to bend down as far when tending to patients. Also, patients can swing around and get up more easily from a raised surface. Try, if possible, to get all-steel furniture, which can be cleaned more thoroughly. Wood-framed, canvas models really should be burned after two uses at most.

Beds or cots are not always necessary. I once convalesced several days after a serious, deep cut on my foot in northern Minnesota by lying on a tent tarp bottom stuffed with ferns and pine boughs. (I had beached my canoe with bare feet on a sandy area that, unbeknown to me, was strewn with shattered soda bottles compliments of two slob campers.)

- Bedding—Sheets, blankets, pillows, pillow cases. Sleeping bags may do in a pinch, but good ones are expensive and require special cleaning and care.
- Hammocks or chairs—To be located outside the shelter for convalescing patients to take in the sun and fresh air or for a weary nurse to take a load off. Hammocks can double as patient bedding inside the shelter in an emergency.
- Sterile bedside tables or trays—To lay out supplies. Stainless steel works well. The more portable and/or mobile the better.
- Bedpans and urinals—Buy at department or drugstores. They are not available at animal health centers.

- Covered bins—Important to have on hand two types here: one for laundry; one for garbage, waste, and other disposables.
- Paracord—Lots of it. Great for a myriad of nursing-specific (as well as general) uses, including everything from providing a place to hang medical charts to lashing a temporary splint.
- Storage locker—You may consider having one good-sized storage locker inside the shelter to house both everyday-use items such as surgical gloves and quick-need emergency things such as epinephrine, which would do absolutely no good if it were buried in a crate under a tarp 40 yards out behind the shelter while the patient under your nose is going into anaphylactic shock!
- Other storage—Another vital yet often overlooked aspect of survival nursing. For this you may find it wise to lay back several 12 x 20-foot heavy plastic tarps, lots of rope, an ax and small hand saw with which to make stakes, a sewing kit for repairs to canvas and tents, a sledge hammer, and even one or more large wall tents aside from what you may be using as your primary shelter. Knowing where to scrounge things like large pieces of insulating carpet and heavy ridge poles is also important.
- A complete tool kit—For both construction and repairs.
- Chain saw and accessories—Discussed in detail in Chapter 4. Accessories include extra chains, files, guides, oil, gas, gloves, plus alternative wood-cutting tools (axes, mauls, wedges).
- Cooking equipment—No mystery here. Along with stoves, heaters, and burners, you are going to have to lay back pots and pans, bowls and plates, eating utensils, among other things, plus the appropriate cleaning gear. As a general guide, think of what you might need for an extremely elaborate camping, hunting, or rafting trip.
- Water vessels—Steel pots, buckets, and pans in which to heat it; various large plastic vessels to store it.
- Laundry facilities—Covered in detail in Chapter 5.

- Sewing gear—Extremely vital and often overlooked! During the Civil War, clothes mending was considered an important part of patient health and survival. It is today as well, yet needles and thread are on few people's list of survival supplies. If sufficient generator power is available, a sewing machine or two will pay enormous dividends in relieving some of a survival nurse's workload.
- Bathing facilities—Buckets, solar showers (available in camping stores), soap, washcloths, sponges. As with a latrine, be careful that soapy waste water does not contaminate nearby water supplies.
- Mosquito nets and insecticides—Especially vital in tropical and/or swampy areas. Even in northern climes, biting deer flies and such can at times reach plague-like infestation levels.
- Flashlights, lanterns, and other alternative lighting sources—Because patient care does not cease when the sun goes down.
- Pads and pens—For recording patients' conditions and record keeping. One important consideration here: *do not* identify the patient by name on charts and records. The authorities could conceivably get their hands on this paperwork, and the less intelligence you provide them the better. Instead, use codenames or generic descriptions (e.g., Male #2 or, even better, Cot #2). If the patient is especially "hot," you might consider burning his or her particular set of charts. Otherwise, these medical records are useful to have on hand to help diagnose and treat similar cases in the future.
- Clipboards—For the above.
- Specialized equipment—Traction devices, exercise equipment, physical rehabilitation items, and so on. Some of these may be considered a luxury.

An Antiseptic Attitude

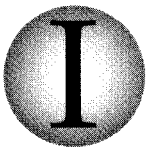

In all cases, sanitation and cleanliness must be a preoccupation for survival nurses. In that regard, I knew a family who migrated from the southeast United States to our farming community in another part of the country. They lived in a cabin with a dirt floor. Their ancient laundry facilities were out under an old elm tree. If I recall correctly, the mother hauled water from the creek. This was certainly not conducive to spotless living, yet the family was known far and wide for their clean, neat appearance. Even the little kids didn't run around barefoot-slobbery dirty. Their clothes were always clean and neat. As far as I know, they only had a washtub to bathe in!

The point is, cleanliness and sanitation *can* be maintained with a little effort even under the most primitive of conditions. Here are some of the major sanitation issues that every survival nursing program will need to address in order to be successful.

SCRUBBING DOWN

It was Betty Lou's day to pull down the gallon jug of Kenic Parvo-Lan-128 disinfectant made by Glo-Marr and disinfect her medical facility. Barring any unforeseen blood cases (chopped fingers or toes or teeth to pull), she assumed her shelter would be empty for several days. She also whispered a silent prayer that any emergencies might be treated as outpatient situations rather than as pure, in-house nursing. This allowed her to go in, remove all the beds and stands, and clean the joint out thoroughly, as she put it.

"Is veterinarian-grade Kenic the best material to use to disinfect?" we asked.

"It is, because it is readily available at most vet supply stores, is reasonably inexpensive, and can be used without rinsing afterward," Betty Lou said. "It also cuts offensive odors, which really build up in a place like this, giving me reason to use it rather than an equally common Fort Dodge Company product named Nolvasan/Chlorosan. That stuff sells for a full \$10 more per gallon of concentrate."

Both are used at rates of 1 to 3 fluid ounces per gallon of wash water. Higher concentrations are only recommended when the area can't be thoroughly cleaned of residual dust and dirt. Kenic, however, is not recommended for disinfecting butcher areas. Nolvasan is preferred for this, but only if the area can be washed down thoroughly before the disinfectant is applied and then washed up with clean, hot water afterward.

Betty Lou recommends starting the disinfectant process by boiling enough water to wash the entire nursing shelter. Her main water-heating facilities are in a kitchen up the hill from her nursing station. She normally tries to drive hot water from the kitchen to her area, but frequent torrential tropical downpours rut the road so severely that she cannot always rely on vehicle or animal transport to fetch the buckets of scalding-hot water required for cleaning duties.

Ideally, thorough cleanups are done when no patients are present and everything can be moved out. Even walls and

An Antiseptic Attitude

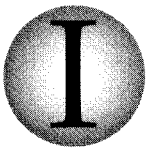

In all cases, sanitation and cleanliness must be a preoccupation for survival nurses. In that regard, I knew a family who migrated from the southeast United States to our farming community in another part of the country. They lived in a cabin with a dirt floor. Their ancient laundry facilities were out under an old elm tree. If I recall correctly, the mother hauled water from the creek. This was certainly not conducive to spotless living, yet the family was known far and wide for their clean, neat appearance. Even the little kids didn't run around barefoot-slobbery dirty. Their clothes were always clean and neat. As far as I know, they only had a washtub to bathe in!

The point is, cleanliness and sanitation *can* be maintained with a little effort even under the most primitive of conditions. Here are some of the major sanitation issues that every survival nursing program will need to address in order to be successful.

SCRUBBING DOWN

It was Betty Lou's day to pull down the gallon jug of Kenic Parvo-Lan-128 disinfectant made by Glo-Marr and disinfect her medical facility. Barring any unforeseen blood cases (chopped fingers or toes or teeth to pull), she assumed her shelter would be empty for several days. She also whispered a silent prayer that any emergencies might be treated as outpatient situations rather than as pure, in-house nursing. This allowed her to go in, remove all the beds and stands, and clean the joint out thoroughly, as she put it.

"Is veterinarian-grade Kenic the best material to use to disinfect?" we asked.

"It is, because it is readily available at most vet supply stores, is reasonably inexpensive, and can be used without rinsing afterward," Betty Lou said. "It also cuts offensive odors, which really build up in a place like this, giving me reason to use it rather than an equally common Fort Dodge Company product named Nolvasan/Chlorosan. That stuff sells for a full \$10 more per gallon of concentrate."

Both are used at rates of 1 to 3 fluid ounces per gallon of wash water. Higher concentrations are only recommended when the area can't be thoroughly cleaned of residual dust and dirt. Kenic, however, is not recommended for disinfecting butcher areas. Nolvasan is preferred for this, but only if the area can be washed down thoroughly before the disinfectant is applied and then washed up with clean, hot water afterward.

Betty Lou recommends starting the disinfectant process by boiling enough water to wash the entire nursing shelter. Her main water-heating facilities are in a kitchen up the hill from her nursing station. She normally tries to drive hot water from the kitchen to her area, but frequent torrential tropical downpours rut the road so severely that she cannot always rely on vehicle or animal transport to fetch the buckets of scalding-hot water required for cleaning duties.

Ideally, thorough cleanups are done when no patients are present and everything can be moved out. Even walls and



Nolvasan disinfectant. One ounce per gallon will kill even deadly AIDS viruses.

roofs in permanent facilities are sponged down and damp-mopped with disinfectant solution. No matter the type of shelter, the premises and furniture should be cleaned and disinfected once a week or between patients.

Wash permanent floors by sweeping thoroughly, washing down, and then washing down again with a stiff, bristly brush and disinfectant solution. If renewing supplies is not a problem, use more than 3 ounces per gallon concentrations of disinfectants on rough floors.

If it is a tent, pull the ground tarp out and hang it over a very stout piece of rope strung between two trees or poles. Using a heavily bristled brush, knock off all the external dirt and grime possible. (Depending on weather and outside conditions, heavy traffic areas such as the entrance to the tent may be caked with mud.) Beating the entrance ground tarp with a wire rod or thin stick may break up some of these dirt pieces, allowing them to fall free. Some nurses then clean their tarps with water before sweeping and disinfecting. Others are more in a hurry; they put disinfectant in all of the wash water. Instead of cleaning first, they clean and disinfect once and let it go at that.

Tent walls can be scrubbed down with disinfectant. In dirty, dusty areas it may be necessary to sweep them first, especially when the tent has been used for a long time without cleaning, but not before removing everything inside first so it doesn't all get covered with grime dislodged into the air from the sweeping.

No matter what type of shelter is used, nursing areas should be kept simple and free of extensive furniture stands and racks. Placing a padded chair outside where the patient can go to take the sun and fresh air is much better than putting it in the shelter. Upholstered furniture may be a magnet for germs and is very tough to disinfect properly.

Also, keeping nursing areas uncluttered makes it easier to pull all of the stuff out when it's time to wash down the area with disinfectant. If you cannot pull out everything, at least clean surfaces and where furniture legs touch the ground. Betty

Lou, for instance, places her water pitcher stand up on 2 x 4-inch blocks so all she really needs to do is clean the floor underneath.

In serious cases, a tent can be disassembled and washed down before reassembling in another place. Even some buildings can, at least in theory, be taken down, exposed to the sun, and then reassembled after 30 to 40 days. Betty Lou says she intends to do just that with her nursing station if, for instance, an especially tough case of anthrax ever appears. As of this writing she still operates in the same originally constructed building. (One of the reasons is her cement floor. Steel-reinforced concrete slabs can be moved using large tractors, but it is a lot of trouble. The reason to move must be serious.)

SOLID WASTE DISPOSAL

Sanitary disposal of medical trash and junk from the retreat will be a major issue. In many cases, this stuff (old bandages, cotton, cleanup rags, packaging, etc.) can be burned. In a particularly desperate situation, burning old packages may be a security measure to prevent outsiders from knowing where you got your medical supplies.

Burning campfire style out in the open won't cut it; too much material is left unburned because the uncontained fire is not hot enough to do the job. Instead, survival nurses will require an old-fashioned wood or coal-stoked burn barrel.

These are simple devices, but you must know the basics to make them work properly, especially in a nursing situation that demands more cleanliness than at average survival retreats. Overloading the barrel or leaving it full of half-burned bandages is a bad situation. Should flies invade the filthy mess and start spreading disease, you are in a world of trouble!

Start with a 55-gallon steel barrel that has no top or one from which the top can be cut. I use a torch to cut off tops, but a hammer and cold chisel will work just as well, if disconcertingly slow. (Burn barrels burn up or rust out after about a year of service, but their life can be prolonged a bit by dropping this cutout top into the bottom as a kind of double protective

layer.) Once the top is removed, shoot about twelve 9mm holes or larger in the bottom third ring of the barrel. These vent holes are vital to the device's proper function.

To use, first place some easily combustible materials such as pine logs or branches in the bottom and light them. Feed the flames with the materials to be burned.

After the bottom fuel logs have burned up the contents of the barrel, use a rake or shovel to stir the ashes. Ash seems to be a fair insulator, causing some paper and rag not to burn unless stirring takes place. Also, the contents will burn more rapidly with less telltale smoke if stirred, allowing more oxygen in through the vent holes.

Ash buildup in the burn barrel should be modest if only appropriate items are run through the device. No metal or glass and only modest quantities of plastics are the rule. Thick newspapers and magazines can be burned if stirred frequently.

Whatever happens, do not allow waste—including bloody bandages, swabs, and cleanup material—to remain in the barrel more than a few hours, especially in tough weather when the fire barrel might be rained or snowed on. Most nurses remove their burnables immediately from the burn barrel. Then, weather permitting, a new fire is started each day.

Again, use caution regarding how many plastics are placed among the burnables. Some will consume themselves, but too many will create the stinking mess you are trying to avoid.

Don't try to burn the considerable waste generated by the cooking, canning, or butchering processes. Cooking and canning waste goes out as compost on the garden, to be plowed under later.

There may be a sanitary as well as security problem when dealing with large-critter entrails, especially if you are situated among a local population that doesn't want deer killed and eaten. In many areas, scavenger birds such as ravens, crows, and magpies will quickly devour any soft tissue left from gutting large critters, but if everything isn't gone by nightfall and/or the presence of birds is raising an alarm, shovel a few generous scoops of soil on top of the remains.

AN ANTISEPTIC ATTITUDE

109

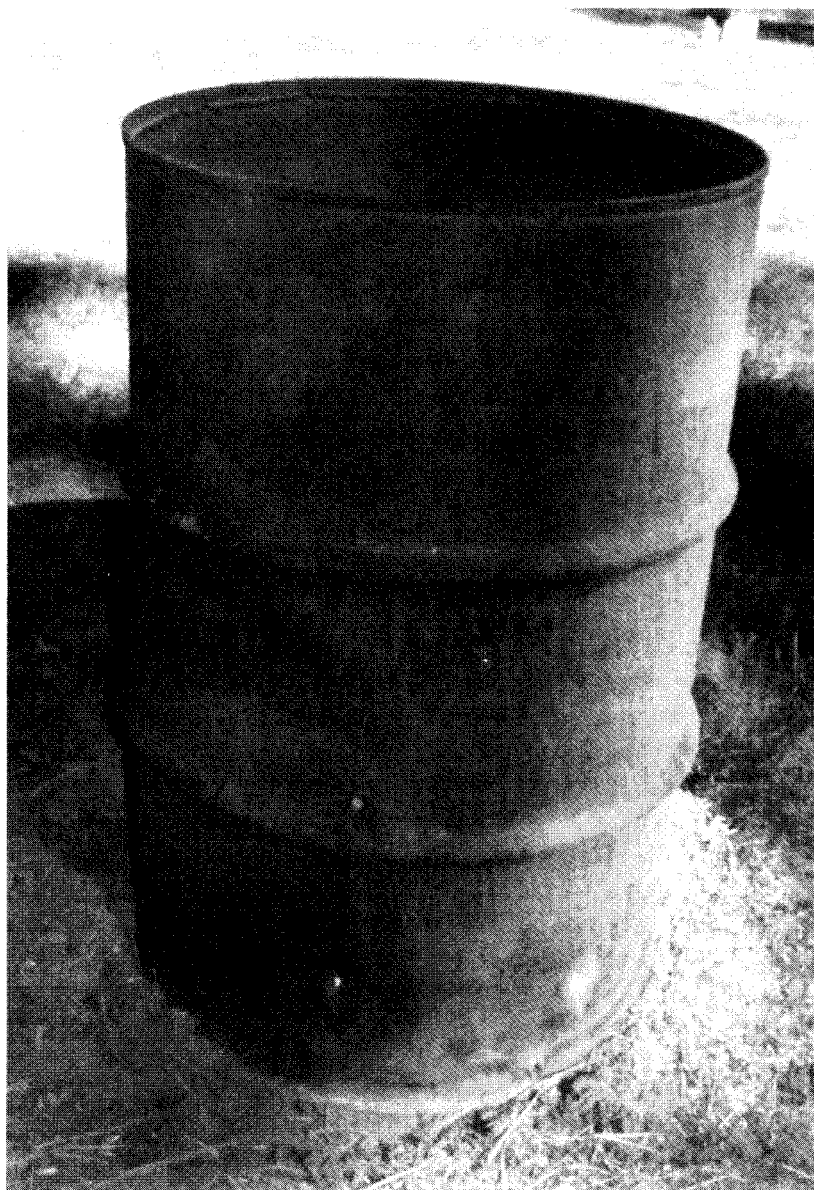

A 55-gallon steel burn barrel for disposal of soiled waste and other burnable trash. Note the vent holes.

Entrails taken from small critters—including pheasants, squirrels, rabbits, pigeons, and goats—can be unpleasant to deal with. Seems as though there isn't much there per critter, but what there is can build up around the retreat rather quickly, attracting scavengers and insects. To get rid of the stuff, we use a post-hole digger to bore a hole down about 2 feet in the garden or shrubbery bed. Entrails are deposited in this hole and covered lightly with soil. Deeper holes can be used two or three times before filling.

HANDLING HUMAN WASTE

Rumor has it that in many backwoods camps the latrine buildings are the best in camp. This is probably because of our natural desire for privacy and a properly sheltered facility to do our business.

One of the first things a survival nurse should try to do before patients start arriving is install some sort of sewer system so they can have the use of an inside toilet, a facility many of us take for granted. This is not always possible, especially when the nursing station may be forced to move from place to place frequently. Yet some sort of sanitary latrine is essential. We will probably need the backwoods equivalent of a two-holer.

We had a two-holer (so-named because two people can use the facility at the same time) while living and working in Africa. It was a wood frame with a canvas covering, and it really attracted snakes. We had the camp staff check the place out each morning and evening. When they found a snake, they promptly cut the head off.

Depending how long one intends to use the facility, a latrine hole should be from 4 to 6 feet deep. Locate the hole downhill away from the water supply and at least 150 feet from the retreat. Any latrine pit must never be able to seep or leach into groundwater, thus ruling out facilities close to lakes or streams. Taking general wind directions into consideration is also wise.

All latrines, even in very hot, dry climates, should have a protective roof. Although a simple lean-to made of layered

pine boughs works for a roof, many backcountry latrines are laid out under a thick canopy of trees that in and of themselves act as a kind of roof.

Place a simple 6-inch log securely along one edge of the hole as a place to sit. You can also wire a log, which can be much longer than the pit, to two trees at about 30 inches high. It ain't fancy, but it is a place to sit or—in the case of a nursing situation—a convenient hard spot on to which you can tap out refuse from a soiled bedpan into the hole.

If at all practical, lay in a supply of powdered agricultural lime with which to treat the pit. Treat as needed, or once a week at the least. Treatments need not be heavy—a 50-pound bag of lime could theoretically last 60 days or more, depending on the season and how much the pit is used. Lime does help prolong the life of the pit by decreasing volume of waste.

What happens if there is no time or energy to dig a pit? Sanitary requirements must still remain in force around the nursing retreat. Issue everyone a shovel along with firm directions about how far and in what direction to travel to the designated burial area. This is very much a temporary measure. After a month or two, the ground around the retreat can



Common lumberyard powdered lime used to keep privies clean and sanitary.

become pretty scarred and unsanitary, especially if you are dealing with a patient with dysentery.

Out of toilet paper, or want to preserve precious stored supplies for patients? Fortunately, nature provides plenty of usable substitutes all within easy grasp. Fresh leaves, soft plants such as sagebrush, smooth rocks, even snow all work fine. Just be sure it is established camp practice to wash hands thoroughly afterward.

STERILIZING INSTRUMENTS

Survival nurses won't generally be responsible for surgical procedures, but they will be required to clean wounds periodically, remove stitches, and provide similar small-wound care. Therefore there will be hypodermic needles, hemostats, scissors, surgical knives, and blades to sterilize. Hospitals throw this stuff out after one contaminating use, but I cannot envision this being done by survival nurses working in tough circumstances.

In times past we boiled medical instruments for 30 minutes in an open pan on the stove. Certainly this was not a truly sterile procedure, and it took far too much energy. Metal instruments can be sterilized in a 400° F oven for 20 minutes, but nowadays we have a type of home autoclave using our pressure cooker pot. It's a variation of our clothes autoclave, only rigged to sterilize hard instruments rather than cloth. With it we can adjust 10 pounds of pressure at 250° F for 30 minutes, deploying a minimal amount of energy in the process.

Proper sterilization is a combination of heat, pressure, and time. To do this properly, place spacers and a rack in the bottom of the pressure cooker and add 4 cups of filtered water. Place a pan on the rack loosely piled with items to be sterilized. Lock down the lid on the pressure cooker and add flame to the bottom of the pot until the water inside boils, raising internal pressure and heat. Watch the gauge to be sure all the water doesn't boil away because of an overly vigorous flame, and keep track of the time.

At the end of the cycle, allow the pot to cool down naturally before opening. This extends the life of the pressure cycle and makes handling the instruments inside a bit easier. Place everything in new, sealed zip-lock bags. As a variation, a nurse in Kodiak, Alaska, uses her vacuum food-sealing machine to enclose her instruments in sealed plastic bags.



The lesson is brutally simple. Those who don't learn to keep their retreats antiseptically clean and neat are quickly going to become ex-survival nurses as they lose their patients!

Doctor's Orders

During the Civil War, it was common wisdom among medical professionals, such as they were, that the quicker they removed wounded patients out of forward collection and treatment points into private homes, the better the chances for recovery. Private citizens of that era knew little about disease, infection, and surgery, but neither did the professionals, so oftentimes a home served just as well as a hospital for patient care and recovery.

Although 19th-century doctors sometimes didn't think twice about exploring bullet holes with dirty, unwashed fingers, Civil War nurses knew intuitively that cleanliness was next to godliness. Consequently, their first duties upon receiving patients included (1) cleaning them thoroughly, (2) providing clean, neat, orderly bedding, (3) laundering and repairing their clothes, and (4) getting a good, nutritious meal into them.

In a modern survival context, the quicker we get

our patients out of a hospital and into our own facilities the better . . . but for a very different reason. In a survival situation, many of our patients may be in danger from the authorities. Hiding them at an obscure nursing station may decrease the overall quality and scope of available medical care, but it may actually *increase* their chances of making it overall! This is true in many Third World countries today such as Cuba, Kenya, and Canada, where governments control medical treatment via a central authority.

Regarding initial care, a survival nurse can only hope that it is actually provided by experienced, trained medical professionals who can give additional advice on the patient's long-term care. In other words, if you are instructed to give your patient 500 mg of penicillin twice a day and clean and wash the wound once a day or as needed, let's hope it is not a dental assistant, veterinarian, druggist, or common citizen with Red Cross first aid training making these recommendations, no matter how good-hearted and caring.

We are dealing with frail humans who can easily be lost or permanently disfigured as a result of our lack of research, laziness, or plain old good-hearted ineptitude. With any luck, there will be someone qualified on hand to tell you what to do next. If not common sense, the most uncommon of senses must prevail under survival conditions.

In that regard, survival nurses will require a good library of books on medical topics they will likely encounter for instruction in proper, effective treatment. In my opinion, they absolutely *must* have the following on hand for immediate reference:

- A good, general medical dictionary. Don't scrimp and save here; buy the best. Otherwise you may not know what other, even simple medical volumes are describing.
- *U.S. Army Special Forces Medical Handbook*, ST 31-91B. Available from Paladin Press, the U.S. Government Printing Office, or military manual resellers, or by having a photocopy made from a copy at a local government repository (usually a university library or military archive). U.S. gov-



Survival nurses will find these five books of special value.

ernment books are not copyrighted, so photocopying this text is perfectly legal.

- *A Barefoot Doctor's Manual*. Published by Running Press, 125 South 22nd Street, Philadelphia, PA 19103. Although heavy on medical herbs, native cures, acupuncture, and propaganda, this English reprint of the official Chinese paramedical manual is of great value to survival nurses. It outlines simple, down-to-earth, nontechnical handling of most medical treatments. Some of the recommendations conflict with other medical books as a result of Chinese efforts to dramatically simplify everything.
- *Where There Is No Doctor: A Village Health Care Handbook* by David Werner of the Hesperian Foundation, Box 1692, Palo Alto, CA 94302. This is a simple, easy-to-read, well-indexed volume that is of great value to survival nurses.
- *The Ship's Medicine Chest and Medical Aid at Sea*. Available through the Superintendent of Documents, U.S. Government Printing Office, Washington, D.C. 20402.

Another heavily illustrated, heavily indexed volume of great practical value to survival nurses.

Even for trained professionals, often the toughest portion of any nursing situation is the diagnosis. There are numerous cases of both nurse and patient dying of an infectious disease because it wasn't figured out in time. Well-referenced, indexed, illustrated volumes that one can systematically work through are of tremendous value. All of the above meet this criterion.

(Incidentally, beware that some of these books have philosophical axes to grind. *Where There Is No Doctor*, for instance, wails about greedy pharmacy proprietors who dispense antibiotics willy-nilly. As a matter of national pride, *A Barefoot Doctor's Manual* pushes traditional Chinese acupuncture and herbal medications. These books contain a lot of truly useful information, but sometimes you have to read between the lines to get to it.)

Now, let's suppose you receive a patient without much or any explanation of his condition or he comes to you in such poor shape that nothing your resources say or do regarding the poor fellow's state is helpful. Where to start?

First, do a "benchmark analysis." If at all possible, look very carefully at the patient's wound or condition. Obviously looking at a suspected ulcer is impossible, but perhaps he can tell you about it. More likely it will be a mangled leg or ripped-open arm you are dealing with. In any case, establish what it looks like and/or how your patient feels at the time so it will be possible to see if there is future deterioration or healing. The goal here is to establish a benchmark.

Sounds corny, kind of like playing doctor or nurse, but first note down the patient's age, height, weight, pulse, blood pressure if possible, as well as his general condition. Look at things like eye and fingernail color as well as frequency of urine and feces elimination. Carefully note whether the patient may be diabetic or perhaps suffering from a coronary.

Note carefully the condition of any wound, break, or burn. How often must it be cleaned or its dressing changed? Are the stitches red and angry or pussy looking? What medications are desirable? How do these demands for medication and attention match your current supplies? What additional supplies must be obtained? By what means?

It is only through these simple, common-sense procedures that nurses will be able to determine what steps to take and whether there is improvement in the days ahead. How to know if a patient is improving? When swelling goes down, his appetite improves, he starts moving around a bit more, and other obvious signs of vitality and health.

Sewing Patients Back Together



Stitching patients is one of those tasks that should be handled correctly by an experienced health care person. But, the job may not have been adequately or correctly done in the first place, and survival nurses all too frequently inherit the problem. How to proceed?

PRELIMINARY PREPARATIONS AND CONSIDERATIONS

First off, do not—repeat *do not*—attempt to close a wound that is (1) over 12 hours old, (2) shows any sign of infection, (3) cannot be thoroughly, absolutely cleaned and disinfected.

Wounds more than 12 hours old may be cleaned using Betadine solution or, when nothing else is available, soap and lots of clean, boiled water. A weak peroxide solution will also help clean and disinfect a new or old wound. One that has been left

overlong without cleaning or closing virtually must be treated with Betadine solution or peroxide. Alcohol is a poor third choice, but it will work if the patient can stand the pain.

Always use huge quantities of water to soften and wash out wounds. In Africa it was common practice for native nurses to put water in their mouths, which they expertly sprayed on the wound to wash it out. Perhaps subsequent washing in peroxide or Betadine overcame this basically unsanitary practice! I would much rather put sterilized water in a 20cc syringe with a number 16 needle and use it as a high-pressure washout system.

All foreign material must be removed from the wound. This may include picking out small pieces of gravel, pulling out splinters, and even cutting away severely damaged portions of flesh. (An acquaintance of mine once had a serious abrasion on his face literally scrubbed clean of embedded dirt and gravel with a toothbrush!) Be certain that forceps, tweezers, scalpels, and all other tools are thoroughly sterilized. Use lidocaine solution or 2 percent lidocaine hemorrhoid medication as a topical painkiller. The processes of cleaning and stitching can be very painful, so do whatever is possible to ease the discomfort of your patient. This will make your job easier.

What to do with a wound that has been stitched up but now shows signs of serious infection? Cut and remove the stitches. Open the wound and clean it with Betadine solution or peroxide. *Don't try to restitch it.* An ugly scar will result, but better this than a patient with such a bad infection that an arm or leg must be removed.

Keep in mind that regular, old-fashioned honey can substitute for modern antibiotic wound medications on an almost one-to-one basis. This is an incredible secret that few people seem interested in using or even believing. It's what healers used to dramatic effect in ancient times and during the Middle Ages. Try smearing a little honey on your next scrape or cut and you will see that it works amazingly well. (For a complete discussion of the use of sugar-based antibacterials to treat wounds, see *Ditch Medicine: Advanced Field Procedures for*



Personal disinfectants used on patients. Betadine (left) is excellent for cleaning out wounds requiring stitches.

Emergencies by Hugh Coffee, available from Paladin Press.) Another little-known antiseptic solution is off-the-shelf pink-eye medication for cattle. I like to dust it into open wounds; it almost miraculously promotes healing.

Not all wounds need to be closed with stitches. This is good news for those who have never practiced sewing up animals or even sewn a tear in a coat or a tent. Tape, if properly applied, can be used in place of stitches to pull the wound together and will work even for some fairly large cuts. Usually it is best if the tape is butterflyed (i.e., cut so only a tiny bridge of material actually covers the wound) to minimize the amount sticking directly on the wound.

THE PROCEDURE

There are two methods of stitching wounds closed: using a continuous rolling loop of stitching material or placing



Sewing up a wounded foot in rural Africa.

individual little stitches, each with its own knot. Sewing people is somewhat like sewing together two pieces of cloth end to end—run the needle down through the skin, out the bottom of one side, into the other side on the bottom, then up and out the top.

Start stitching at one end of the wound: this makes closing easier and turns out more professional looking. Never start in the middle unless it is a temporary stitch. Just barely snug the two sides of the cut together without forming a pressure ridge in the center. Make enough stitches to close the entire wound nicely. Rolling or continuous stitches tend to leave a wound with a noticeable ridgeline running down the center.

Surgeons tie their suture knots by running the needle clear through and pulling the thread up through the stitch so only about 2 inches of tail shows on one side. Wrap three turns of loose thread on the needle end around the holder. Reach through these three coils and pull the loose end back through, forming a knot. Pull everything through to the proper snugness and knot again. Cut with the surgical scissors and go on to make the next stitch. If you do it correctly, the needle won't have to be rethreaded.

When the wound is very deep it may be necessary to close it with several subsurface stitches. By merely closing and stitching the top layer over this suturing, there should be no open or dead space beneath the surface. Absolute sterility is mandatory here.

Regular surgeon's needles are not required for suturing but are generally easier to work with. Common tailor's sewing needles and thread work just as well, provided that everything is completely sterilized. What *is* required—and of vital importance—is a locking hemostat-type needle holder. Needles appropriate for sewing people are just too small and slick to work without a locking holder. Also, you will be surprised at how tough and needle-resistant human skin really is. That's another reason amateurs should use supersharp veterinarian or medical-grade suture needles if they are available.

Use the smallest needle and thread that will do the job. This causes far less discomfort to the patient. Regular tailor's silk, nylon, or even cotton thread (though a relatively poor third choice) will work, provided that it has been autoclaved for 30 minutes at 10 pounds of pressure.

In some circumstances it will be necessary to place a tight covering bandage over the wound to keep dirt out. There is another practical reason for this at a survival retreat. Even a seriously wounded patient can, after proper cleaning, stitching, and dressing, help with some daily chores. Depending on the wound, these might include prepping vegetables for storage, feeding the animals, digging potatoes, even something as rigorous as splitting wood. Before engaging in what might be a dirty chore, the wound must be protected against outside contamination by covering it thoroughly.



Other than the obvious pain that it causes, stitching people up is fairly simple and straightforward. The biggest test of skill involves cleaning the wound properly and then closing it to just the right place.

Pulling Teeth

By definition, survival nurses receive their patients already sewn, set, and diagnosed. From this point, their duty is to nurse the patient back to good health and some semblance of normalcy. Survival nurses should stay away from the heavy lifting of medical service.

Exceptions occur, however. When they do, it is usually in the form of providing additional stitching, fiddling with a splint, or treating rampant diarrhea. But one of the bigger hands-on procedures a survival nurse may face is extracting teeth.

Undertaken in a survival circumstance, tooth extraction is often one of the most bewildering and difficult tasks to confront inexperienced survival nurses. Most survival manuals dealing with dentistry dwell almost exclusively on prevention. This is fine in the long run but fails miserably to help deal with emergencies. If confronted with an emergency tooth extraction, here is how to proceed.

PRELIMINARY PREPARATION AND CONSIDERATIONS

First, if you have a patient who suddenly develops badly swollen gums around an infected, hurting tooth, put him on a fairly heavy antibiotic regimen. Oral antibiotics in this case work as well or better than injectables. If you are using veterinarian antibiotics, establish dosages and frequency at levels recommended for pigs of the same weight as the patient.

Treating with antibiotics won't cure the tooth. It will, however, give the patient some relief while allowing you time to collect your thoughts. Extracting teeth is often as traumatic for the nurse as it is for the patient. Diseased teeth can be extracted without anesthetics of any kind, but it certainly is tough (although extracting really bad teeth is often made a bit easier by the fact that the gums holding them have also deteriorated).

Many infected teeth are so painful that sufferers are thankful for any relief, with or without numbing agents. Nonetheless, hopefully you will have a supply of 2 percent injectable lidocaine and 1 1/2 to 2-inch needles to deaden the patient's jaw nerves. Consult *Gray's Anatomy* or a similar text for the location of nerves in the jaw near the bad tooth. Inject 1 or 2cc of medication until gum and tooth are fast asleep. Test for deadness by tapping the bad tooth with a metal instrument. When the patient no longer gnashes the tool in half reacting to pain, it is time to stop giving injections and go to work.

Before diving in, consult *Gray's* regarding configuration of the affected tooth. Teeth are like snowflakes—no two are exactly alike. Front teeth have different root structures than rear teeth, and you may find surprises in the form of twisted or missing roots, half the tooth rotted away, or whatever.

Your goal is to take the tooth out whole along with all of its roots. If it does not come out whole, the jaw will have to be cut down sufficiently to find and grab any missing pieces. Everything must be removed or the patient will suffer from infection, which may endanger other healthy teeth.

THE EXTRACTION

Teeth are extracted using special plier-like tools with built-in grabbing cusps. These concave clamps hold the tooth firmly without crushing it. Some models are constructed with offset jaws, allowing you to reach back into the rear of the mouth to grasp a tooth. Some dentists claim they might be able to pull teeth using conventional pliers, but all say it would be tough for them and virtually impossible for beginners.

In that regard, survival nurses have an especially tough row to hoe if they must use common mechanic-type tools in lieu of professional dental instruments. Teeth needing extraction are generally those weakened by age, disease, malnutrition, infection, or old fillings. Splitting and crushing these weakened teeth in the jaw is a real possibility if you're using equipment that's less than ideal.

Survival nurses can help their situation somewhat by modifying conventional offset jaw pliers. Do this by grinding the jaws flat and then grinding a shallow concave (indented) cavity in them. This cavity acts as a bit of a cusp with which to hold the tooth. Do all of this while the antibiotics are taking effect or well beforehand, *not* while waiting for the anesthetic to set in! Be certain to thoroughly disinfect this and any other "tool" used for tooth extractions. This can be done very simply by placing metal tools in a 400° F oven for 15 minutes.

Again, be sure you have given the anesthetic plenty of time to work. You are not running a production line, and he is about to receive plenty of grief without getting in a hurry about it. In fact, dentists of old frequently plied their clients with strong whiskey before getting to the rough stuff. Also be sure you have allotted ample time to deal with this one patient, since it will not do to have to run off in the middle of a tooth extraction to empty some other patient's bedpan!

Start the actual extraction process by rocking the targeted tooth back and forth and side to side in the jaw to loosen it. Keep working it back and forth gently but firmly, but be alert for a little snap which may indicate that you have proceeded

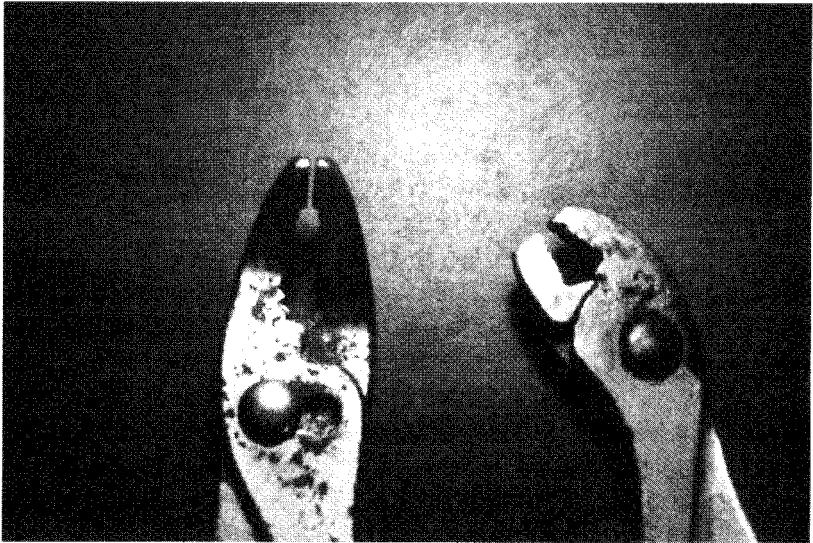

Two common mechanics' pliers that can be modified for removal of teeth.



Grind the jaws down flat on offset mechanics' pliers to use to grasp and extract teeth.

PULLING TEETH

131



When other painkillers are not available, it may help to give the patient a stiff shot of booze.

too roughly and broken a root off in the gum. Next, use a blunted, medium-sized screwdriver to push the tooth from side to side and the pliers to turn and pull it with increased seriousness. Be very careful not to slip with the screwdriver and poke the patient's cheek.

This constant rocking, twisting, and pulling may take as long as 30 minutes. Once the tooth seems sufficiently loosened in the gum, give it a sharp yank upward with the pliers. With any luck it will come out. (In the old days dentists were known for their strength; it took lots of it to get some teeth out. Professional dentists tell me that, traditionally, only men were sufficiently muscular to pull teeth. Even today, tooth extractions in much of the Third World are done by a husky mechanic under a shade tree.)

Be careful to maintain a firm grasp on the extracted tooth. More than one experienced dentist has lost one down the patient's throat. Swallowing a tooth ranges anywhere from uncomfortable to dangerous. If possible and practical, place a small rag or piece of cotton in the mouth to keep the throat channel protected, although you must be careful and diligent so the patient does not accidentally choke on this rather than the pulled tooth!

THE AFTERMATH

Immediately clean up and examine the tooth after extraction. Look to see that there are no missing or broken roots, pieces, or parts. If there are, look to see if these pieces can be found in the hole in the jaw. Rinse and mop out the bleeding hole in the jaw to get a better view of things.

After being certain the entire tooth is out, use two or three stitches to close the old tooth socket. This may stop bleeding a bit, but chances are that this wound will seep blood for several days, causing nausea in the patient.

Keep up the antibiotic regimen for several more days. It can be reduced a bit, but give the patient this added benefit to help counteract any clumsiness on your part.

Serve only liquid or mashed foods for the first 36 hours after extracting a tooth. Don't chance food getting down into the old tooth cavity. Serious infection can result if this precaution is not taken.

As a general rule, upper teeth are easier to extract than lowers, front teeth more so than rear. Nevertheless, hope that this sometimes common problem does not fall into your lap, especially at a time when there are many other pressing duties to perform.



Obviously, the topic of pulling teeth is not one that can be completely covered in a general medical book such as this. One excellent resource to supplement what I've covered here is the book *Where There Is No Dentist* by Murray Dickson, published by the Hesperian Foundation. Another is a fascinating six-tape video series available from an outfit called DCM Ltd. that covers in often graphic detail exact procedures for pulling teeth. At the time of this writing, the tape series was selling for \$169.95. DCM also offers a dental tool kit to accompany the videos (\$348 for the basic kit, \$625 for the complete version). For more information, contact:

DCM Ltd.
4618 N. Illinois, PMB 212
Fair View Heights, IL 62208-3407

Midwifery

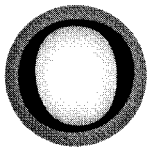

One duty that inexperienced but well-meaning survival nurses may face is delivery of a baby. This is a procedure that really scares many people, since they have the lives and well-being of two generations at stake.

Under normal circumstances, mother does most of the work and everything turns out fine. Women delivering their second or third babies are understandably more relaxed. They still appreciate help, but they can at least offer good suggestions about what help they need.

THE PROPER MIND-SET

First-time mothers may be terrified, so it is of little help if the survival nurse is also terrified. A nurse can be of great help simply by assuring the mother that everything is going to be fine and that she is doing the same thing millions before her have done.

As for the nurse herself, she too should always keep in mind that tens of thousands of human babies are born throughout the world easily and naturally outside of hospitals in what we would term survival conditions. Having assisted in the delivery of some animals is helpful, but it is not essential. Pigs, horses, cattle, and dogs are very relaxed when giving birth and seldom have troubles.

THE PROCESS

Delivery is getting close when the woman begins having regular and periodic uterine contractions (labor pains). These should start 8 to 10 hours before delivery. Normal duration of contractions is no more 24 hours.

The next sign of an imminent delivery is when mother "breaks her water." This is a breaking of the amniotic sac, indicating that the baby has moved lower in the womb and is in a position for delivery. Copious fluids will gush out through the birth canal.

Examine the woman while she lies on her back to try to determine whether the baby is positioned head down for a normal, relatively easy delivery. Have the mother breathe all

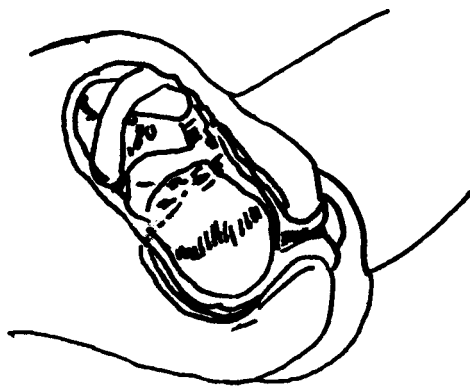

First stage of delivery. Baby drops into birth canal.

the way out. With thumb and two fingers, push on her abdomen just above the pelvic bone. With the other hand, feel at the top of the womb. This gives an instant bracket on the baby to determine its position.

The baby's head should feel round and hard. Its butt feels larger, wider, and softer than the head. If it feels as though the softer, wide part is positioned downward, indicating a butt-first delivery, additional checking should be undertaken.

If you do not have a stethoscope in your medical cache, fashion one from a cup, glass, or cone of cardboard. Listen for the baby's heartbeat by pressing the device down against the mother's stomach with your ear set firmly on the other end. At times it also works to press your ear directly and firmly on the woman's stomach. This is the way doctors and midwives did it for hundreds of years.

A strong heartbeat well below the navel indicates a head-down (normal) delivery. If the heartbeat is loudest above the navel and indications from the mechanical check support the conclusion, delivery will probably be butt first. This will be a much longer, more difficult procedure but one that can still be undertaken in survival circumstances.

If the baby is sideways, which does happen occasionally, delivery at the retreat is going to be extremely dangerous for both mother and child. Some attempt might be made to move the baby slightly in the womb, though it should never be strained or forced, and it may not be effective anyway. A very quick decision must be made as to whether it is advisable or even possible to compromise retreat security by securing professional help. Some survivalists fear, justifiably or not, that the authorities may be more trouble than help. Nonetheless, the decision must be made whether the mother's and baby's lives are in greater danger under the care of the authorities or at the retreat.

Assuming a normal position in the womb and a normal delivery, ask the woman to void both urine and fecal matter one last time before delivery. Have her lie on her back again. Using Betadine solution, wash down her stomach, thighs, and genital area thoroughly.

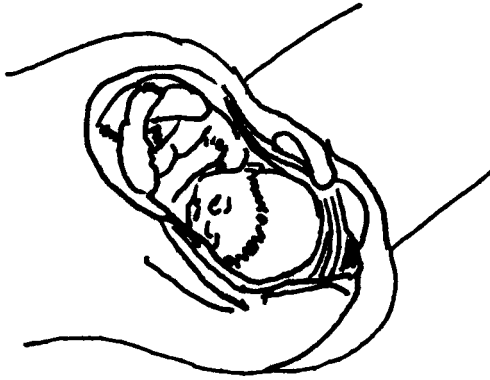

Baby starts passage through birth canal.

First, don't put the Betadine away—it will be needed to wash yourself before putting on rubber gloves for the actual delivery. It is imperative that as little contact as possible be made inside the birth canal, even when your hands have been disinfected and are covered by gloves.

Next, get out a sterilized blanket or towel in which to receive and swaddle the baby. Use sheet-thin blankets in summer or heavy terry cloth ones if there is any chance the baby will be chilled. (Survival retreats are often cooler than hospitals or residences.) You may wish to stoke up the fire if mother feels chilly. Blankets are also necessary because the baby will be slippery.

A new, absolutely clean, sterilized razor is required to cut the umbilical cord after delivery is completed (properly sterilized scissors can be substituted), as is sterilized suture material or thin cord to tie off the cord. Survival nurses may also wish to have several less essential but handy items on hand, including a flashlight to assist examination and a wash basin in which to catch and examine the afterbirth.

Soon the top of the baby's head will appear in the birth canal. Ask mom to stop pushing and to breathe deeply. Harm can result if the birth proceeds too rapidly at this point. Time needs to be given to allow the birth canal to dilate more fully.

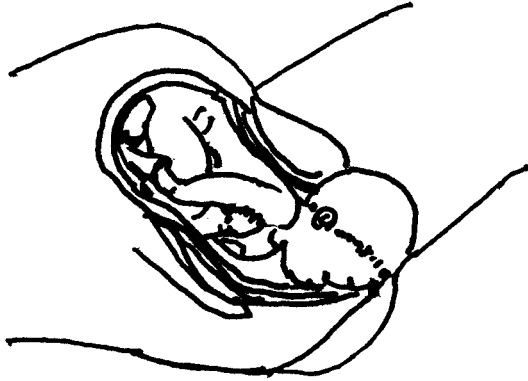

Baby's head clears birth canal.

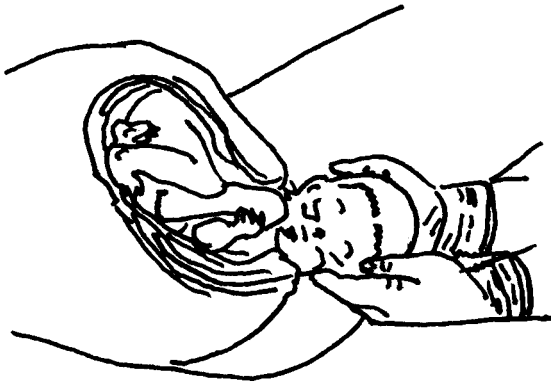

Supporting baby's head.

Some midwives actually push the head back gently to slow progress through the birth canal.

Using a clean, gloved hand, support the baby's head as soon as it clears. With one hand holding the head, press firmly around the birth canal a bit to allow the head to clear fully. Then rock down gently to clear the first shoulder and up again to clear the other. From there, with only gentle support and no

tugging, allow the birth to complete itself. Never pull on the baby's head and neck, no matter how gently.

POST-DELIVERY PROCEDURES

Immediately after the child is born, its umbilical cord will show signs of a pulse and will be relatively fat and blue in color. Wait—don't do anything with the cord yet. You first need to establish that the baby is indeed breathing.

Upon delivery, pick the baby up by both feet to allow mucous in its throat to clear out. It is also acceptable to use a piece of sterilized gauze to wipe mucous out of its mouth. If the baby isn't breathing in 30 seconds, gently massage its back with a soft towel or cloth. If there is no independent breathing at 60 seconds, start mouth-to-mouth resuscitation to see if you can jump-start its breathing.

Place the (slippery) baby, still attached to the mother via the cord, on a sterile towel or cloth in the crook of your arm or on the mother's abdomen. After a few minutes the cord will shrivel, thinning quite a bit. It will also turn white. At this point, tie the cord off in two places—one 3 inches from the baby, the other about 4 inches. Using the sterile razor blade, cut the cord between the two ties. Blood flow should be minimal. Dip the baby's end of the cord in iodine as soon as all signs of bleeding have passed.

Sponge off—but don't bathe—the baby to clean it. Full water baths should not be given for 6 to 8 days, or until the stump of the umbilical cord heals and drops off.

Normally the placenta is passed after about 5 minutes to 1 hour of the birth. If it comes slower than that, don't panic. If only part of it is exposed, don't tug on it. The only cause for concern is if mother is losing too much blood. About half a teacup is normal yet can be sufficient to really scare amateur midwives.

Massage the womb carefully through the lower abdominal wall. This should cause it to contract, get hard, stop the bleeding, and expel the placenta if these things haven't already happened

naturally. If the placenta is not expelled and bleeding continues, temporary relief can be administered by firmly holding the bottom of the womb with one hand through the abdominal wall just above the pelvic bone. Push down firmly from above, just below the rib cage, against the other hand. This procedure should stop the bleeding, giving mama time to heal internally.

If bleeding does continue, there is trouble and it may be necessary to seek professional medical help. If Ergonovine is available, use it only if the placenta has been expelled but bleeding continues. The drug Oxytocin can be used to help expel the placenta if that is the problem.

When the afterbirth finally is delivered, check it thoroughly to be sure nothing is left inside. Bleeding and deadly infection can result if portions remain inside.

Give mom a great deal of liquids to drink if bleeding continues but does not seem severe. Water, fruit juice, tea, and weak soup all will help overcome blood loss.



I have personally been involved with two at-home, do-it-yourself deliveries over the past several years. One went perfectly well, without any complications. In the second case, mom was okay but they couldn't get the baby breathing. Eventually it was lost.

Pages and pages could be—and in fact have been—written about handling difficult deliveries. About all that can be done in a true survival situation is to try to gently massage ill-positioned babies around in the womb so that they are properly presented for birth. Babies too large for the woman to deliver that must be taken by Caesarean are outside the scope of our amateur abilities.

Remember, it is remarkable how much blood a woman can lose and still recover. Not to pass this problem by, but a little blood looks like a large, scary amount to amateurs. Usually mother will heal internally, but she may be forced to stay in bed for a week to 10 days.

To reiterate, both nurse and mother should always remember this basic point: giving birth is extremely natural. It has been going on for literally the entire history of mankind. Of course many women and babies have died in the process, but nevertheless, if you are confronted with a midwife situation, the best advice is not to panic. That way mother will be encouraged and, if she is courageously in charge of delivery, it will often go quicker and easier.

Physical Therapy

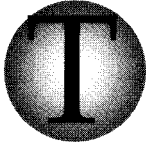

his brief chapter is more philosophical than medical. It explores the fact that often we can help a patient as much with physical therapy as we can with drugs. Since drugs will always be in short supply in any survival nursing retreat, physical therapy as a potential treatment must always be a promising alternative.

A general rule of thumb is that the patient who asks "What are you going to do to make me better?" is at a great disadvantage to the patient who asks "What can I do to get this thing back to normal?" This does not include the super gung-ho individual who feels he can jump up from double broken legs and start in on work as usual. Physical therapy in the form of exercise is desirable here, but nevertheless a little caution *is* in order!

MEDICAL THERAPY SESSIONS

Anyone who has had any contact with modern hospital surgery and postoperative recovery knows that getting a patient up and about soon after surgery is very therapeutic. Visit any hospital surgical recovery ward and you will find all kinds of people working mightily at shuffling up and down the corridor. Those closest to discharge are the most brisk about it.

How much therapy and exercise is wise, and how quickly should it be undertaken in a survival context? We already know that we will probably receive our patients in not as good a condition as those handled uptown by professionals. A great many of ours will be blood cases involving sewn-up bullet wounds or grievous accidents. Many of these patch jobs will be amateurish at best.

So, how quickly should you get these patients into some kind of program to unlimber damaged muscles? The short answer is that muscles set up and atrophy if they are not used, so most patients should be subjected to some therapeutic activity much faster than is generally believed possible. In fact, I vividly recall doctors telling my brother that I should be up and walking 5 hours after an appendectomy. Brother dutifully herded me up and down the corridor of that little hospital and sure enough, the next day I went home.

As a general rule, depending entirely on where the wound is located, start physical therapy for trauma wounds at about 7 days or at a time when the stitching won't be damaged. This should involve levels of exercise that do not threaten the wound. In other words, a simple stretching exercise might be okay except if some especially motivated individual repeats it hundreds of times in ever-increasing intensity. (Survivalists tend to be these type personalities, and survival nurses will have to get used to working with them.) Look at the wound, observe the patient, then use common sense.

Common sense is also required for patients recovering from surgery or wounds in the body cavity. Often it will be necessary for them to stir around a bit to get normal body func-

tions going again. This should occur quickly after repair, but it should also be closely monitored so that it not be greater than the patient can endure. Always keep in mind that an unusually tough regimen today can lead to tomorrow's setback.

In many cases, severely traumatized muscles and joints must be hand-manipulated to get them on the road to flexibility and use. This involves more than your standard backrub, and the patient will have to supplement the process by doing exercises on his own on a regular schedule. This can be some tough manipulation that may initially hurt him quite a bit.

Let's take a real-life example of a badly smashed ankle. We'll assume that the ankle was set by an amateur using a copy of *Gray's Anatomy* but that he was a basically good mechanic who did an adequate job. Unfortunately, our hobbled fellow mucked around too long and muscles and ligaments were thoroughly traumatized. How to proceed?

The cast, in this case, will come off in 6 weeks. Now the joint must be gently massaged and exercised three times daily. Gently take the ankle in your hands and begin to work it. Chances are excellent that the patient won't go to sleep during the process. Keep massaging for sessions of increasing length until after a few days the patient can exercise on his own a bit. Set some specific times during the day when he can stretch and turn the ankle by himself. If necessary, put a chart on the wall that tracks exercise periods and how much movement is possible at what pain level.

Shoulder wounds are similar. You may have to start by heavily massaging and manipulating the muscles. Stop if there is any sign of bruising, bleeding, or internal trauma. It soon should be possible for the patient to move some on his own. Keep him at it until movement increases and pain decreases to fairly normal levels. This may take more time and work than you might first suppose, especially in patients 30 years of age or older.

Physical therapy regimens often last for months rather than weeks. As we used to say on the farm, it may be necessary to set stakes to see progress. Increasing treatment fre-

quency to three to five times daily may speed things, or it may so traumatize your patient that sessions will be perceived as a form of torture. Providing a small dose of aspirin or Tylenol an hour before treatment may help limber up some muscles and joints. Again, use common sense. Don't permit a patient to overwork himself, but don't baby the injury to the point where it begins to set up and atrophy.

WORK THERAPY SESSIONS

We had another saying on the farm that "when you chop your own wood, it warms you twice." Actually there are three warmings if one includes the psychological sense of accomplishment. Given that there will always be a virtually overwhelming amount of work at a nursing retreat, keep in mind that a recovering patient helping with the workload provides a double benefit by (1) allowing the harried nurse to attend to other matters while the patient partakes in physical and psychological therapy himself, and (2) assisting with the accomplishment of such vitally important chores as food preparation, manufacture of energy, and securing water, to name only a few obvious ones.

How hard to work recovering patients during a true emergency is always a good question. Let's say the septic system is plugged. Do you send out a severely crippled patient to start digging up the drain field? Or is this not enough of an emergency to warrant possibly tearing open old wounds or causing so much pain that nothing gets done.

What about digging potatoes? Say they are ready for harvest and it looks like cold, wet weather ahead. The crop and your winter food supply could be lost if someone doesn't get to them. Is this someone the fellow with the banded-up ankle or shoulder?

Again, use common sense along with a sharp evaluation of what is really important. Consider the specific situation along with the patient's ability to truly profit from some productive exercise. The patient who will likely push himself past the point

of good sense needs to be treated differently than the malingerer who cannot or will not help himself or the nursing retreat.

In some cases, time must be given to permit relearning of old tasks under different physical circumstances. I think of the mechanic who chopped off the end of his right index finger in a powerful motor. He had to relearn how to hold little screws and nuts using his second finger rather than the first.



The bottom line is that busted and bruised patients won't be able to bring themselves back to full recovery unless they are provided with some kind of physical therapy. Exact exercises will depend entirely on the nature of the condition or the character and location of the wound. You need to think about these problems during the period when wounds are healing under stitches and bones are mending under casts. Then the hard work of truly bringing the patient back to full recovery begins.

Conclusion



Survival nursing is like growing old—it isn't a job for sissies. Aside from performing duties specifically directed at shepherding a patient back to good health, survival nurses will be expected to accomplish the difficult tasks of growing, scrounging, and trapping food; preserving that food; preparing it in a clean, sanitary, and appealing manner; coming up with adequate, appropriate medical supplies; and seeing to energy, sanitation, water, and security needs of the retreat. The job will tax the skills, resolve, and ambition of the most able among us.

Never lose sight of the fact that the only reason you are taking on the duties of a nurse is because, for some reason, conventional facilities are not available. Maybe it's because you and your group have dropped out of a society that has lost sight of the true meaning of such concepts as individual freedom and "life, liberty, and the pursuit of happiness." Or perhaps the patient is in grave danger

from the authorities and risks capture, imprisonment, or death if he seeks care at a government-run facility.

Because I felt it was my charge to zero in on survival nursing skills rather than security, very little was said about the latter topic. Past experience strongly suggests that if a nurse must also assume active defense responsibilities, her situation becomes intolerable. In that regard, survival nurses must be very good at hiding. Those who are interested in the related issues of security and hiding may want to purchase my book *The Modern Survival Retreat* as a companion to this text.

We don't know how many survival nurses are currently operating in the United States, since by its very nature this activity does not lend itself to counting and statistical analysis. We definitely know that survival nurses operated in occupied Europe during the Second World War, providing care for resistance fighters, fugitives, and Jewish nationals. We also know that survival nursing is common in the Third World. In some cases there, patients cannot reasonably be transported to central medical facilities. In other cases, medical treatment for certain groups of people is illegal. I am, for instance, reliably informed that extending medical treatment to women in rural Afghanistan is very illegal. Treatment is only administered by close women family members if it is administered at all.

In that regard, one of the major lessons of this book is that average Americans who have done little more than go through high school physiology, chemistry, and biology know more about medical cause and effect and general medical care than most current Third Worlders. Read just a few books on the technicalities of survival medicine such as *A Barefoot Doctor's Manual* and *Where There Is No Doctor* and you will know a bunch more.

Another great lesson of this book is that survival nurses absolutely must be people who can plan ahead. Nothing must be left to luck or chance. Preplanning for medical emergencies at a retreat is tough. It's also expensive—medications that are stored go out of condition and must be replaced on a regular basis, a very costly procedure. Yet those who cannot or will

CONCLUSION

151

not thoroughly and meticulously plan ahead will suffer grievous loss. It will be “for want of a nail the kingdom was lost” to quote a tired yet still true cliché. Let’s trust that, for lack of prior planning, you will *not* sit there helpless knowing that you probably would have saved the patient with just an additional cc of penicillin or another week’s worth of fruit, vegetables, and milk.

Most important, by now I hope you realize that only a small part of survival nursing is about medical technique. It’s more about survival in general—about providing sufficient food, water, and energy as well as a friendly recovery environment for patients. Like so many other things in life, it won’t always be fun, but it will always be interesting.

If you liked this book, you will also want to read these:

THE MODERN SURVIVAL RETREAT A New and Vital Approach to Retreat Theory and Practice by Ragnar Benson

Modern retreaters have a new enemy to fear – *our own government*. In this companion to the classic book *The Survival Retreat*, Ragnar answers such vital questions as how to identify exactly who threatens your freedom, when to occupy your retreat and how to fight the government when it goes hard-core against you. 5 1/2 x 8 1/2, softcover, photos, 120 pp.

#MSR

DO-IT-YOURSELF MEDICINE How to Find and Use the Most Effective Antibiotics, Painkillers, Anesthetics, and Other Miracle Drugs . . . Without Costly Doctors' Prescriptions or Hospitals by Ragnar Benson

Ragnar gives you precise instructions for securing and using the very latest drugs and supplies from mail order suppliers, animal health centers, military dispensaries, foreign pharmacies and other unusual sources. 5 1/2 x 8 1/2, softcover, photos, illus., 128 pp.

#DOIT.MED

EXTREME SURVIVAL ALMANAC Everything You Need to Know to Live Through a Shipwreck, Plane Crash, or Any Outdoor Crisis Imaginable by Reid Kincaid

This incredible survival resource is for everyday travelers who have no specialized training or gear. It walks readers step by step through the decisions necessary to reach safety, whether they are stranded in the woods, in their vehicle or at sea. 8 1/2 x 11, softcover, illus., 480 pp.

#ESA

PVC PROJECTS FOR THE OUTDOORSMAN Building Shelters, Camping Gear, Weapons, and More Out of Plastic Pipe by Tom Forbes

The craftsman behind the ghillie suit video *The Invisible Advantage* offers more than 30 projects for outdoor gear and weapons made from inexpensive PVC pipe, from teepees and snowshoes to pugil sticks and blowguns. 5 1/2 x 8 1/2, softcover, photos, illus., 96 pp.

#PVC

U.S. ARMY SPECIAL FORCES MEDICAL HANDBOOK by Glen K. Craig

Paladin's new update of this classic best-seller gives you the info you need to stay alive and stay well in the field by showing how to treat all kinds of diseases and injuries. In a new compact format, this book gives you the knowledge that makes the Special Forces medic so valuable. 4 1/2 x 7 1/4, weatherproof softcover, illus., 608 pp.

#SFM

DITCH MEDICINE Advanced Field Procedures for Emergencies by Hugh L. Coffee

Whether it's a war zone or a civil disaster area, traumatic injuries often occur in remote, unsanitary locations. This book teaches advanced field procedures for small wound repair, care of the infected wound, IV therapy, pain control, amputations, treatment of burns, airway procedures and more. 5 1/2 x 8 1/2, softcover, photos, illus., 224 pp.

#MED

PALADIN PRESS®



ORDER ONLINE
www.paladin-press.com
RESPONSE CODE: BBK

ORDER TOLL FREE
1-800-392-2400
or 1-800-466-6868

PHONE +1.303.443.7250 • FAX +1.303.442.8741 • E-MAIL: service@paladin-press.com

One of the most overlooked topics in the field of survival medicine is *nursing*. Doctors or medically trained survivors can patch up a patient after an injury or accident, but it is the survival nurse who provides extended long-term care as well as the dozens of related activities that support the healing process under less-than-ideal conditions.

This timely companion to Ragnar Benson's best-selling books on survival medicine tackles the many obvious and obscure issues that every serious survival nursing program must face. You will learn:

- the ins and outs of the “big five” considerations of survival nursing—shelter, water, food, energy, and sanitation
- the must-have supplies to keep in stock and how to obtain them
- tricks for handling the mountains of laundry generated by a nursing station
- how to maintain a low profile with your survival nursing station and why it's important
- how to sew up wounds, pull teeth, deliver babies, and provide physical therapy under primitive conditions

Providing personal nursing care along with a healing environment in the midst of difficult survival conditions is a tough calling. This book is an excellent primer in this vital undertaking and is important reading for anyone interested in true self-reliance.

A PALADIN PRESS BOOK

ISBN 1-58160-075-5



Visit our Web site at www.paladin-press.com