

12 GAUGE PUMP-ACTION SHOTGUN

CONSTRUCTION PLANS

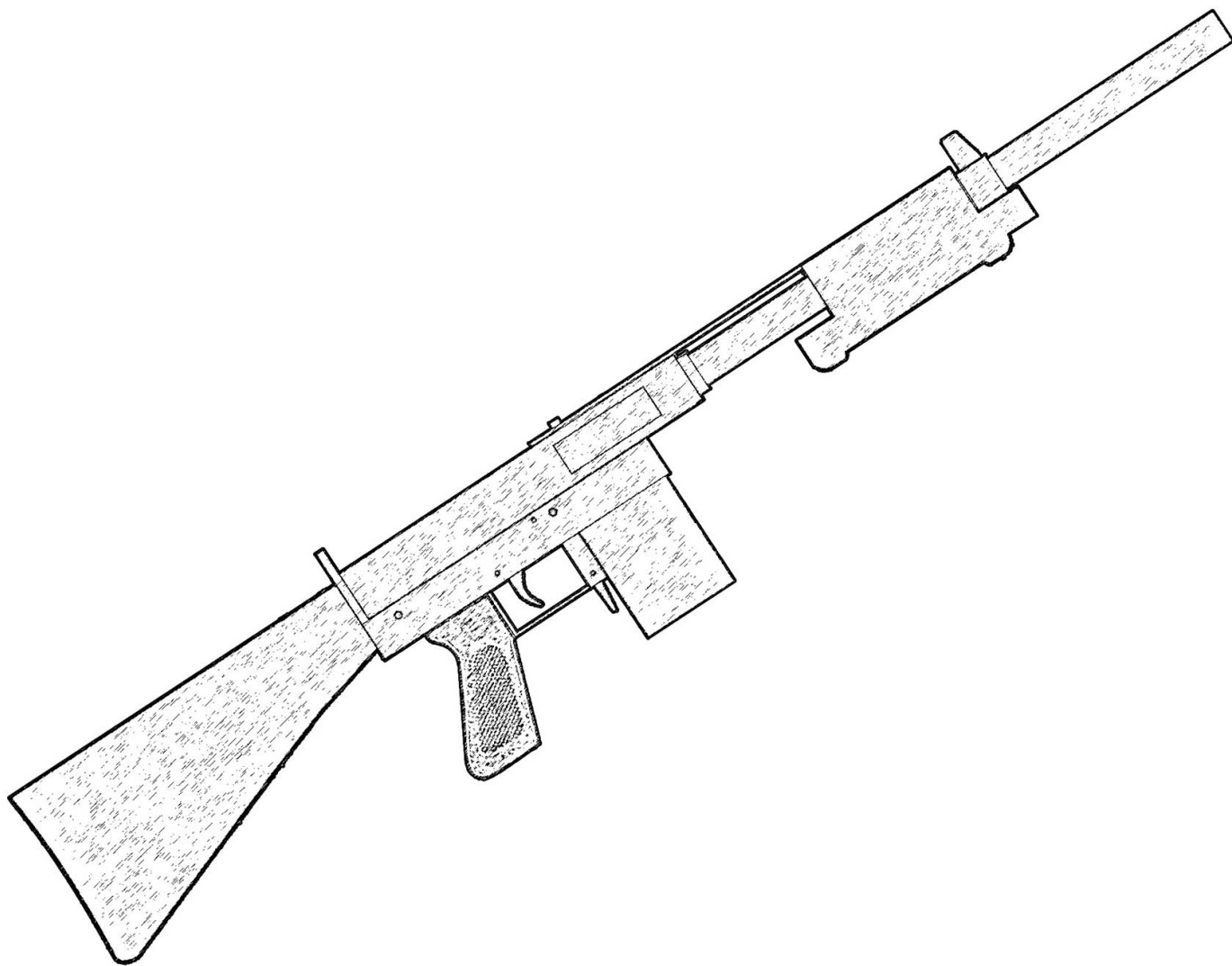

LMT-12

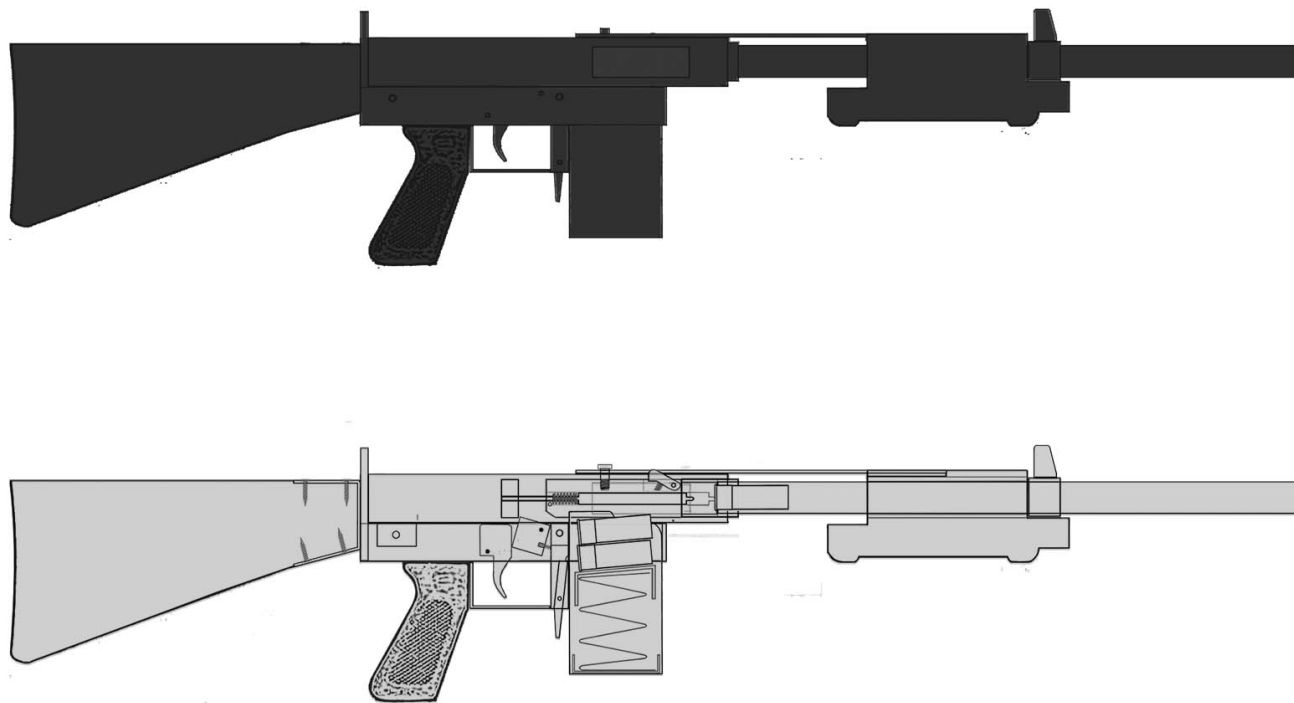

The following 12 gauge pump-action shotgun design can be manufactured in the home environment without the use of a lathe or milling machine. The majority of its components are constructed from standard sizes of steel box section and round tubing, including the barrel. 12 gauge being a cartridge which produces relatively low chamber pressures allows the use of a simple bolt locking mechanism, in this instance a spring loaded lug which is keyed in or out of a hole in the thick-walled upper receiver via the rearward or forward motion of the action bar.

Magazines can be fabricated from rectangular tubing or the design adapted to accept commercially available shotgun magazines such as those offered for the Saiga-12. Additionally, cheap widely available surplus battle rifle magazines such as those made for the FAL, SLR, BAR or G3 can all be easily made to accept and feed 12 gauge shells by simply modifying the feed lips and front wall to allow the cartridges to sit higher and be stripped by the bolt.

Land Maintenance Tool

12 Gauge Detachable Magazine-Fed Repeater

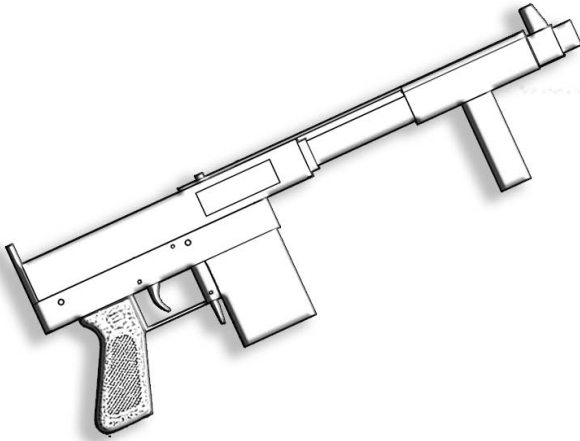

Materials list:

- 38mm x 38mm (1 1/2" OD) x 3mm (.120) mild steel box section
- 30mm x 30mm x 2mm mild steel box section
- 30mm x 2mm (1" ID) mild steel round tube
- 25mm (1" OD) x 2.5mm (3/4" ID) seamless steel round tube
- 2mm thick, 20mm (3/4") wide steel strap
- 25mm (1") dia steel bar
- 30mm dia mild steel round or square bar
- 6mm (1/4") dia steel bar
- 10mm thick steel plate
- 6mm (1/4") thick steel plate
- 2" thick hardwood or plastic

All pages included should be printed out on 8.5 x 11 US letter paper. Each component template is drawn to scale and can be cut out and glued to their respective thickness of material or used as reference for measurements.

Make sure the ruler at the bottom left of each sheet is 2 inches in length. Alternatively, take a screen-shot and enlarge the plans using a computer program until the ruler is the correct length, then trace the parts needed onto a sheet of paper taped over your computer's screen.

For Academic Study Purposes only

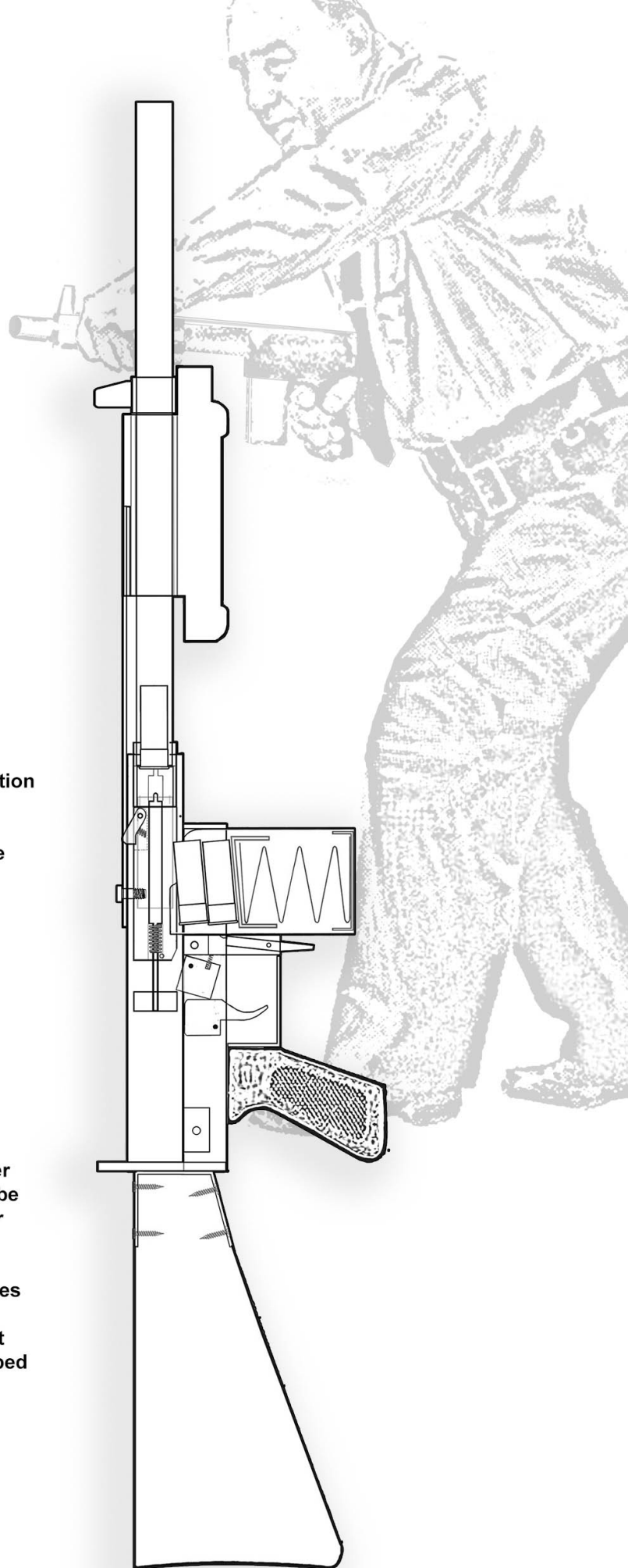

Upper receiver

(Bottom)

281mm long

140mm

50mm

75mm

Magazine slot

20mm

sear slot

10mm

Cut out openings using a combination of chain-drilling holes around the inside of parts marked and slitting using a dremel fitting with a reinforced cut-off disc.

Mild steel square box section

**38mm x 3mm wall
(1 1/2" x .120 wall)**



Upper receiver (Continued)

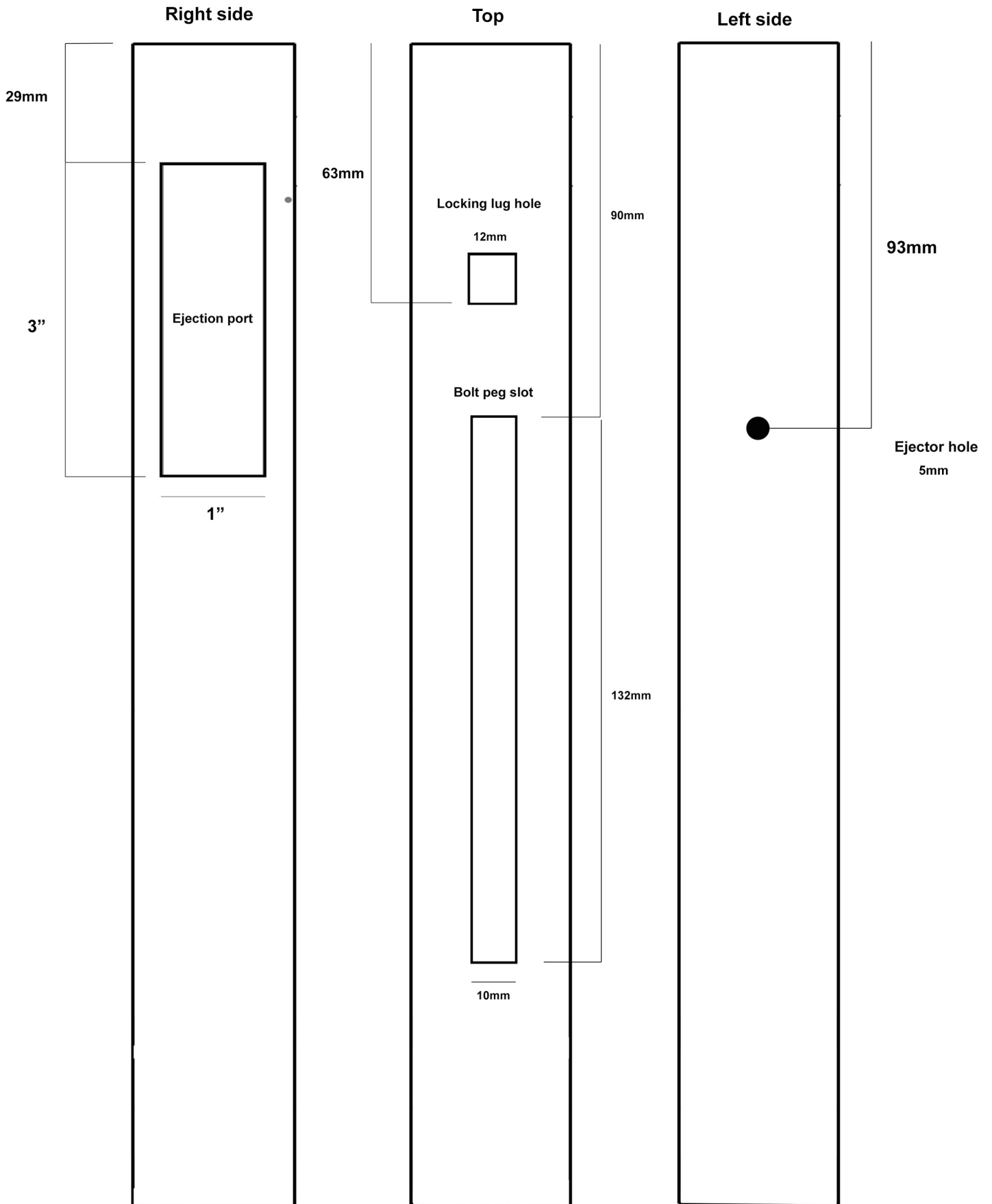

Mounting lugs

Can be made from solid blocks of 1" steel or folded from 3mm thick sheet to match inner dimensions of lower receiver

Drill holes while mounted in the correct position with lower receiver to ensure accurate alignment.
Take-down is achieved via two removable 30mm long 8mm diameter steel pins.

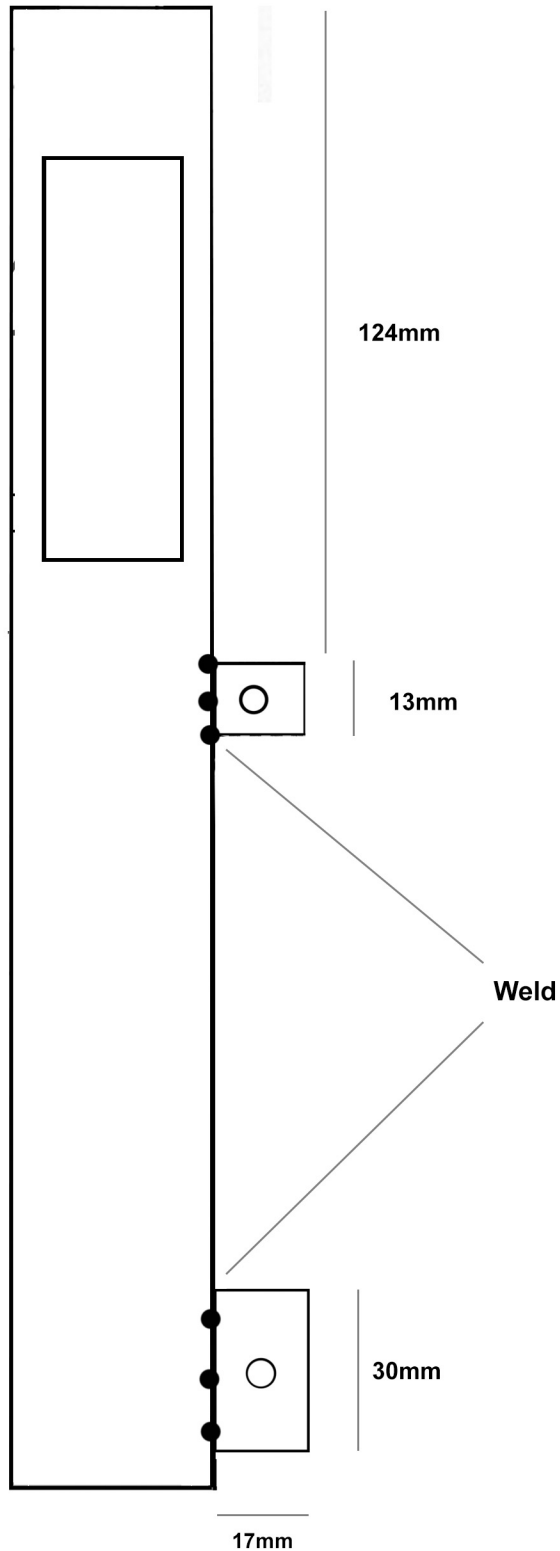

Lower receiver (Right side)

30mm x 30mm x 2mm thick wall
mild steel square box section tubing

236mm long

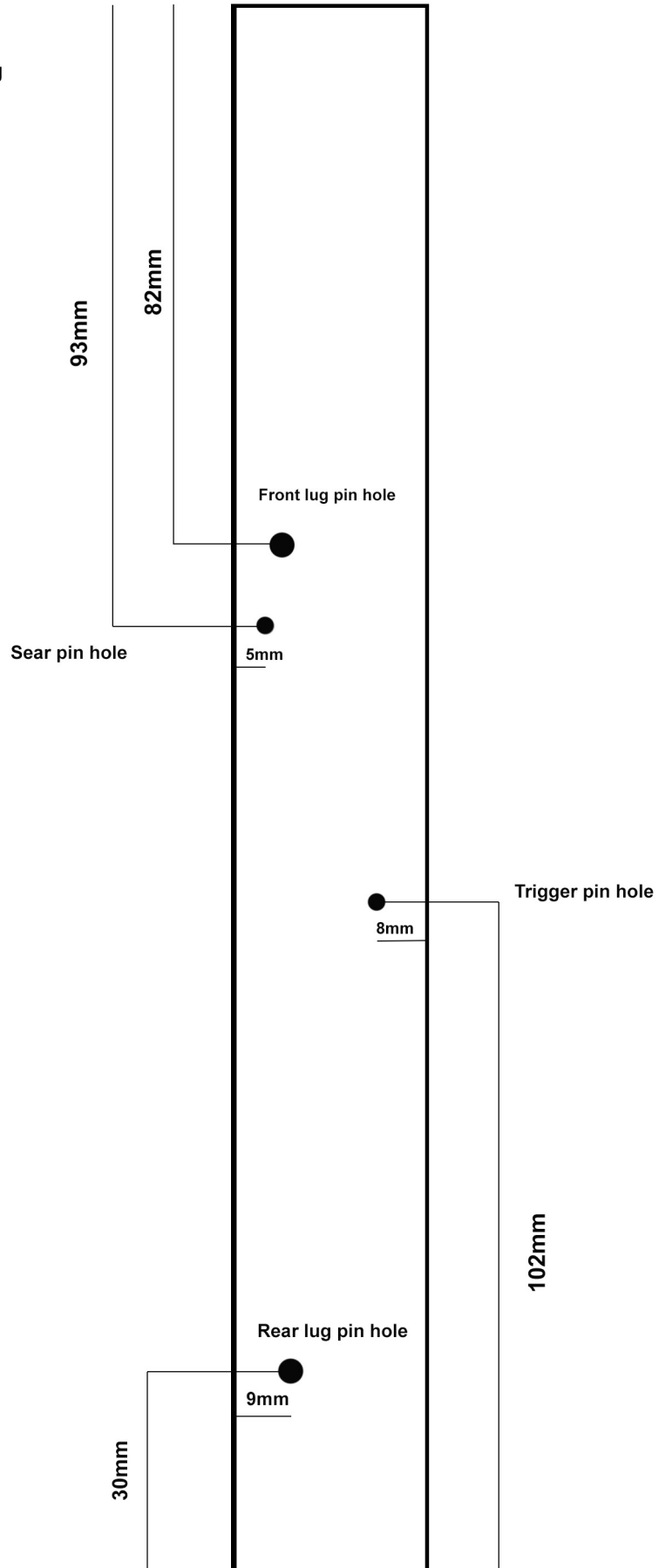

2 inches

**Lower receiver
(Bottom)**

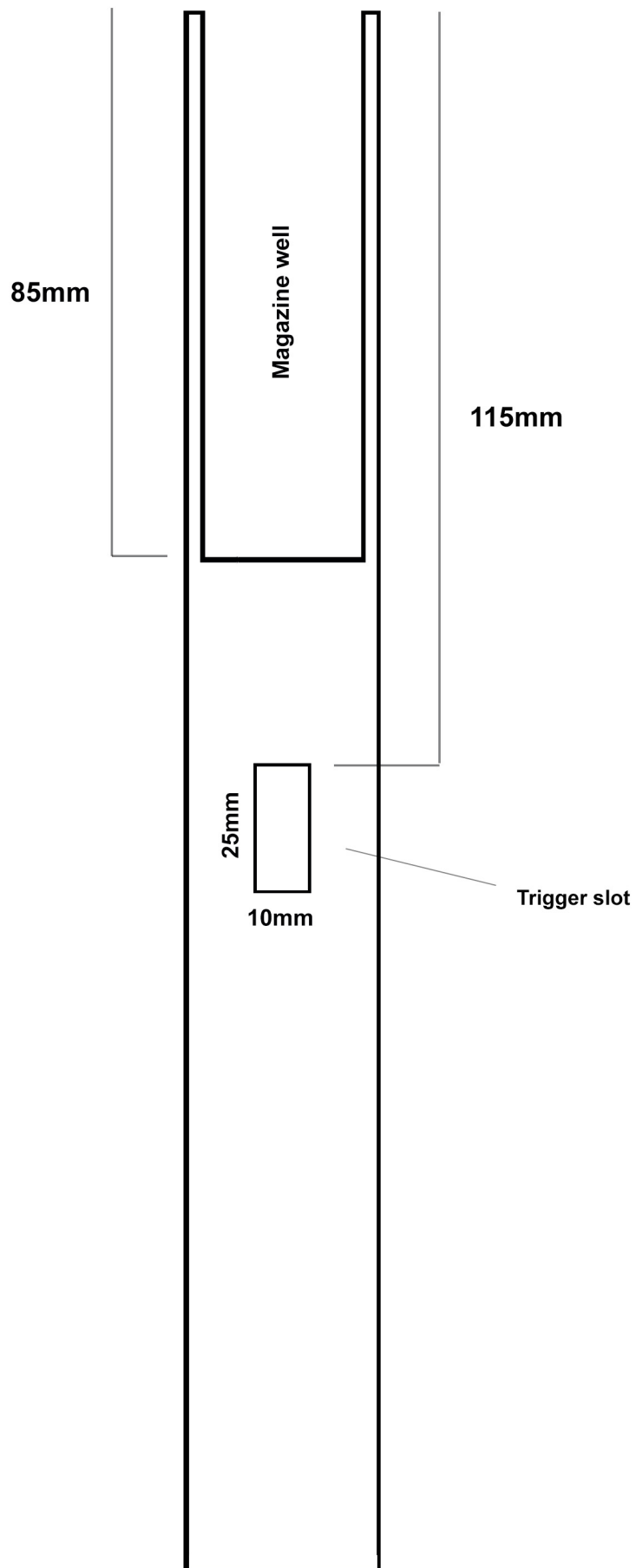

**Lower receiver
(top)**

Slot for upper receiver rear lug

8mm

30mm

14mm

144mm

Slot for back plate

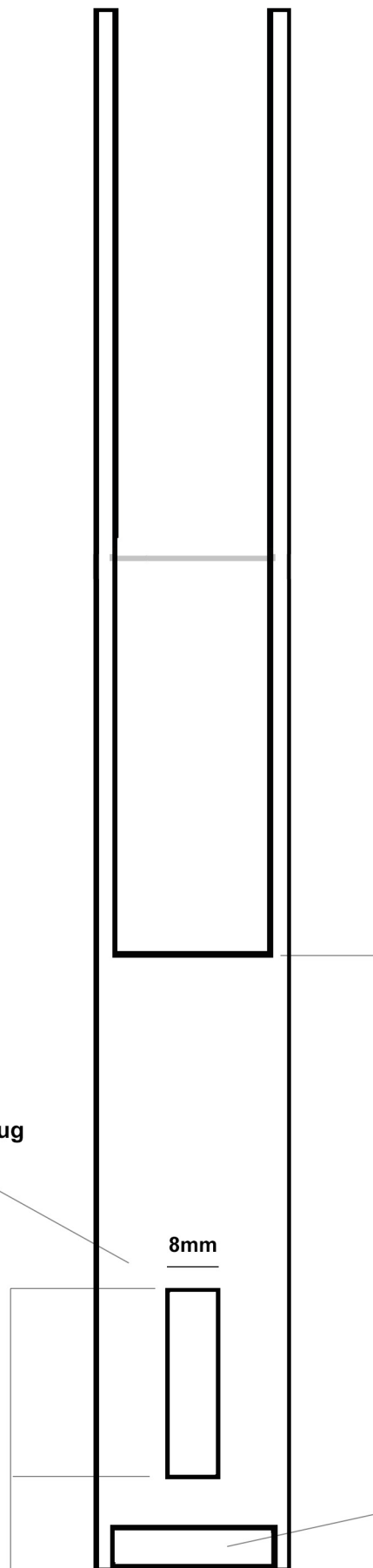

Magazine catch

1/4" thick steel or aluminum plate

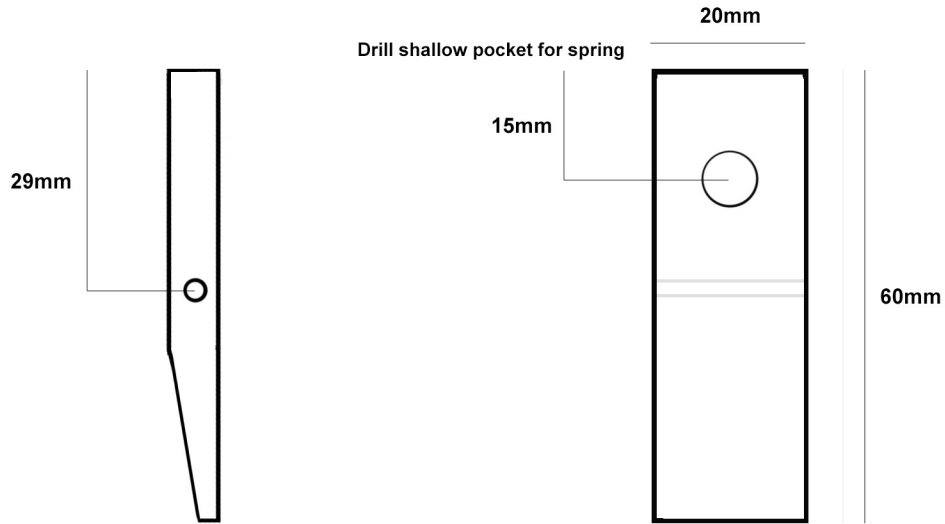

Catch housing

1" square tubing, 65mm long

Secure catch inside housing using a 1" long 3mm dia pin

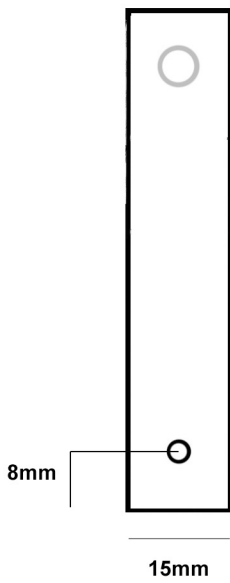

Assembled



2 inches

Rear sight / lower receiver backplate

6mm (1/4") mild steel plate

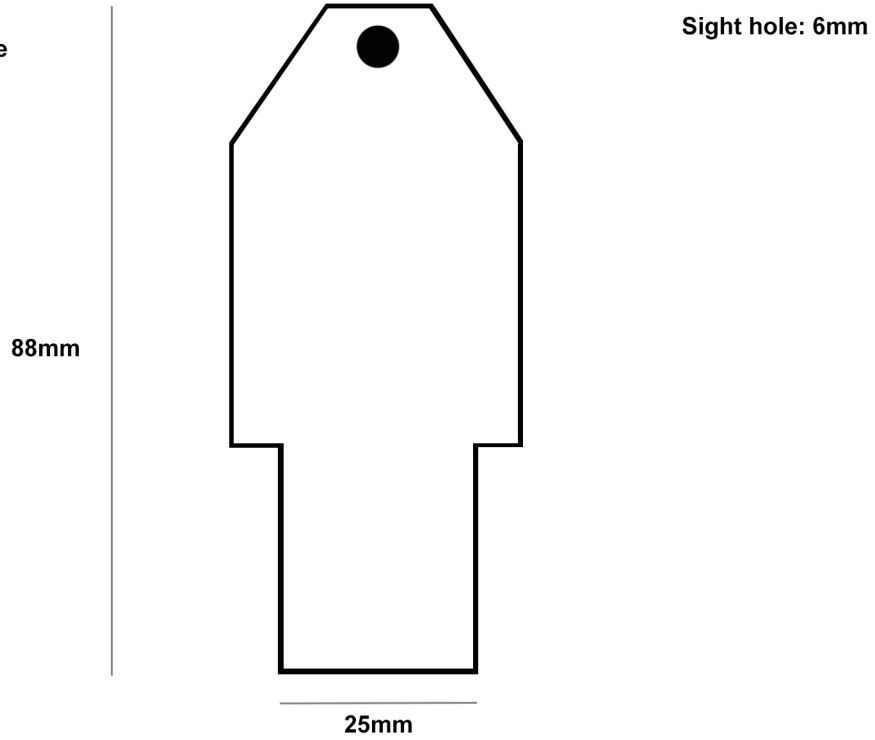

Stock bracket

Bend from 3mm thick 1/2" steel strap

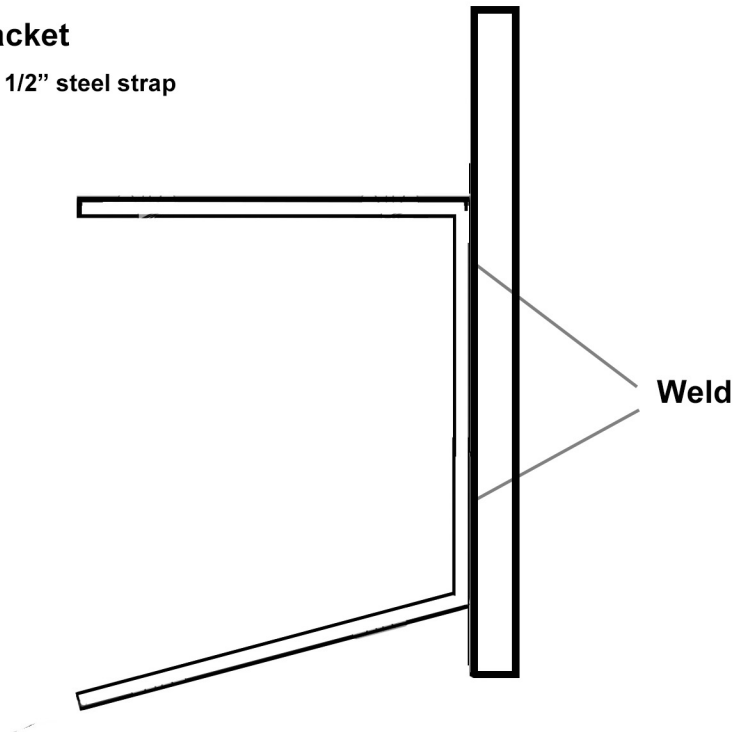

2 inches

Print on 8.5x11 US letter paper

Lower receiver (Assembled)

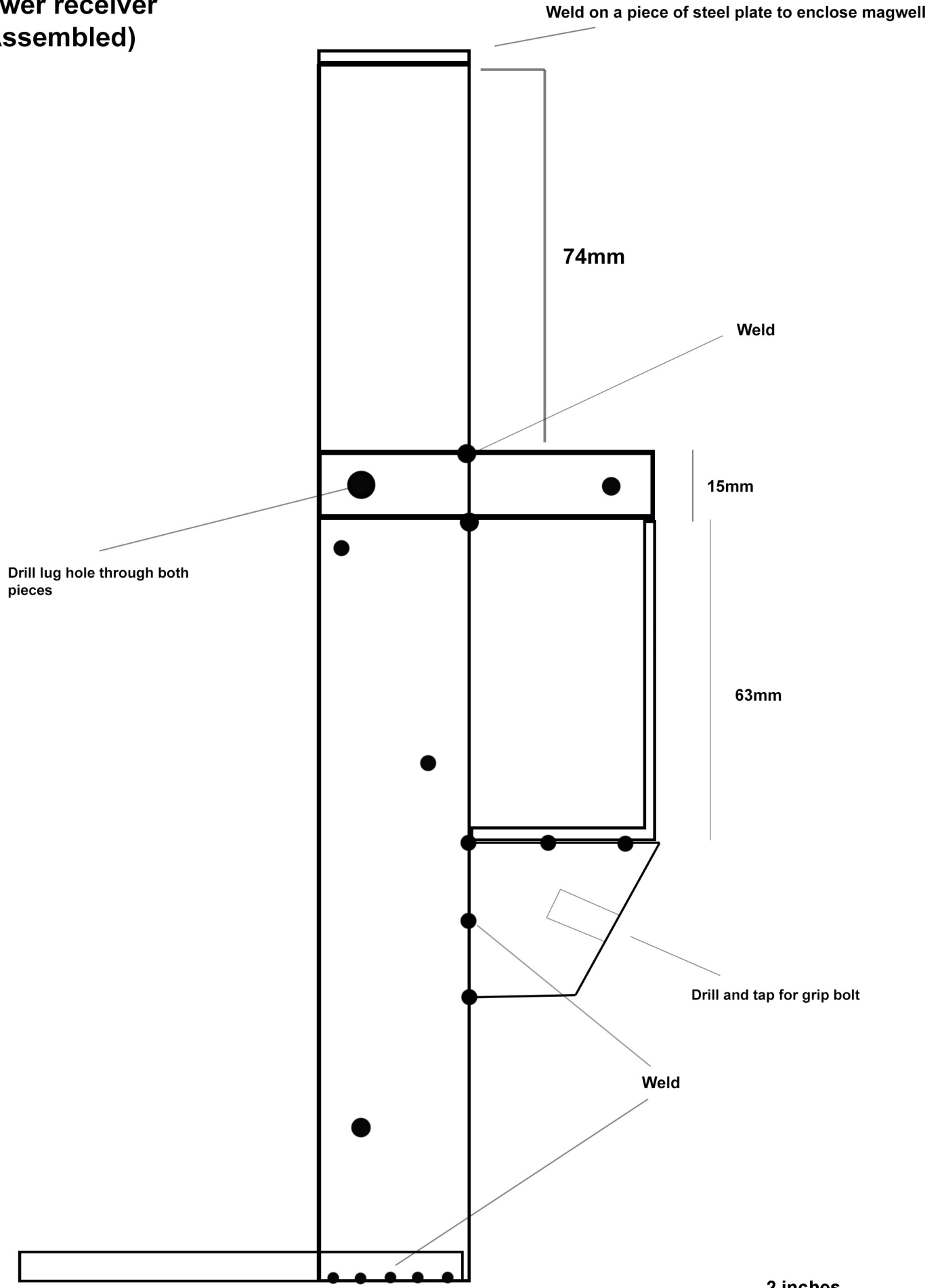

Trigger & sear

10mm thick steel plate

Templates:

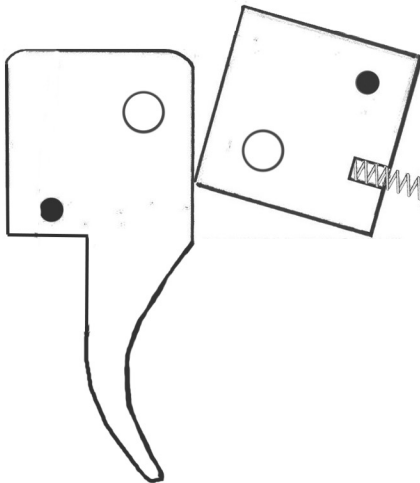
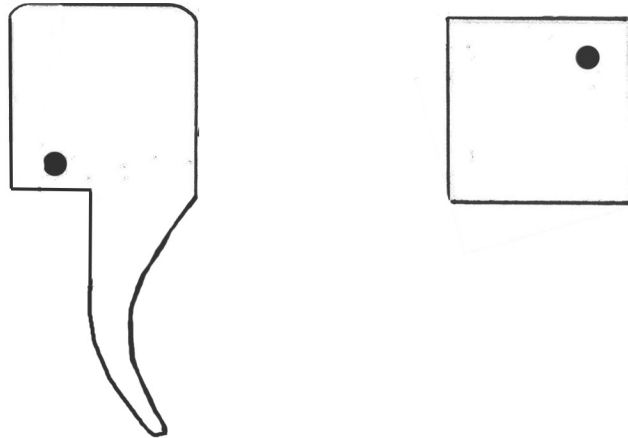

Drill and insert a 1" long 6mm dia steel bar through both trigger & sear to center each component in the lower receiver.
Drill a pocket and insert a small compression spring in position shown on sear

2 inches

Print on 8.5x11 US letter paper

Magazine body

Weld or braze together from 4 pieces of 20 gauge (1mm thick) mild steel sheet.

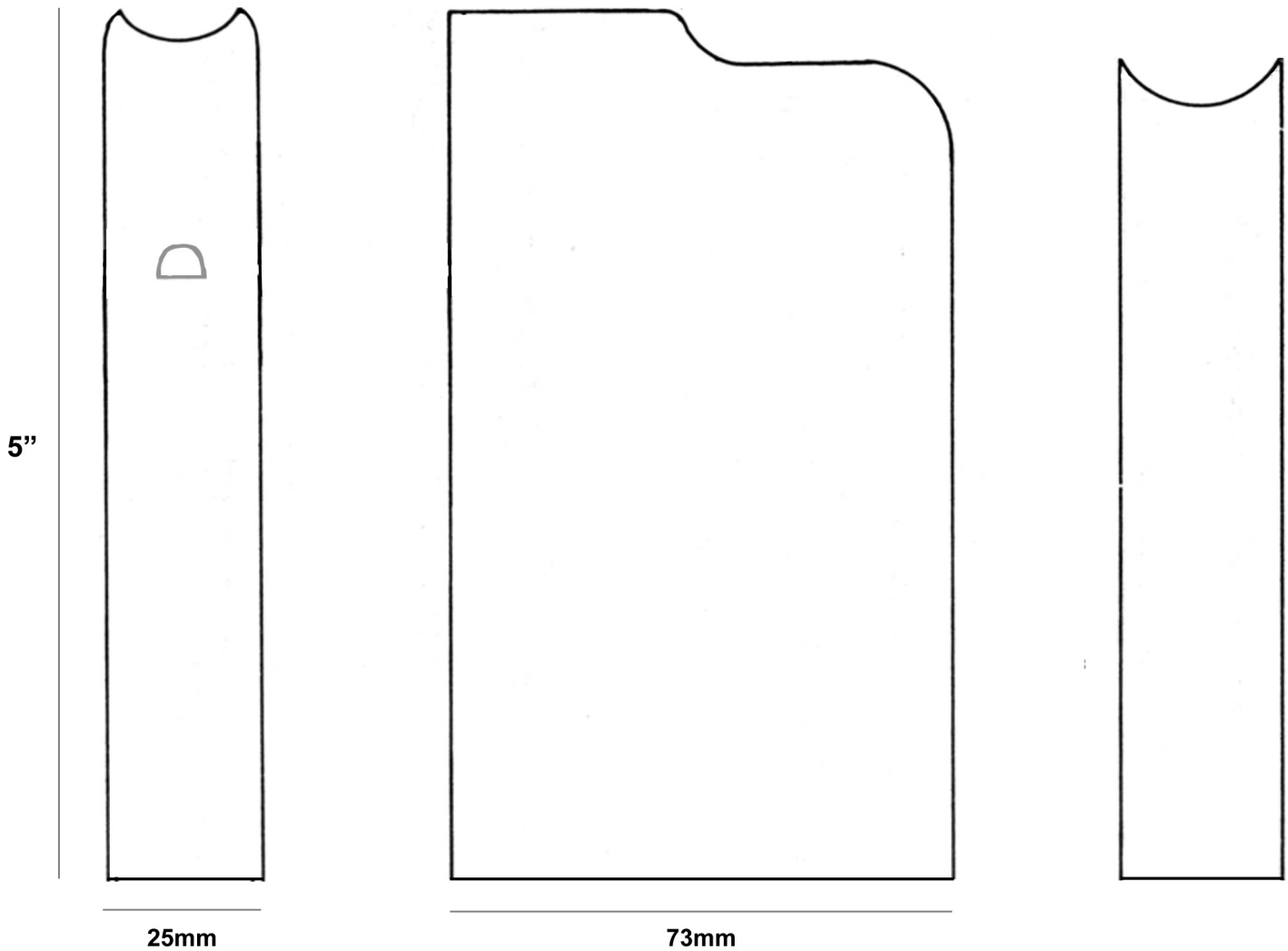

Can also be made by modifying a length of 1" x 2.5" or 1" x 3" rectangular steel or aluminum box section tubing with a wall thickness of 1.5mm. Alternatively FAL, SLR, BAR or G3 magazines may be modified to accept and feed 12 gauge shells.

2 inches

Print on 8.5x11 US letter paper

Magazine spring

Form from .025 flat spring steel strip, 3/4" wide

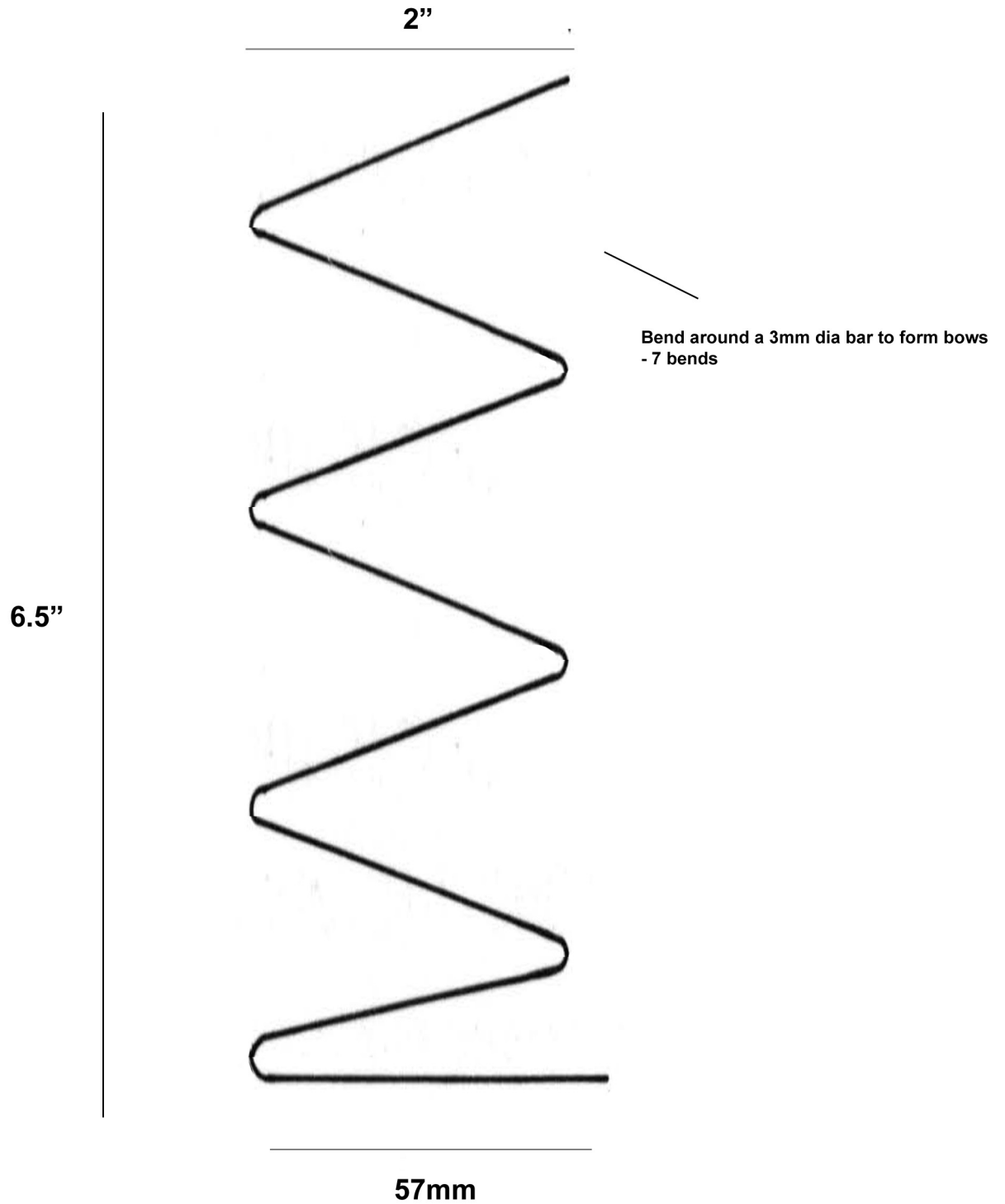

Magazine follower & assembly

Bend from 3mm thick, 20mm wide steel strip

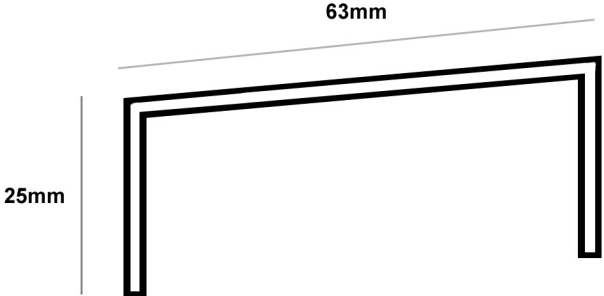

Bend lips inwards

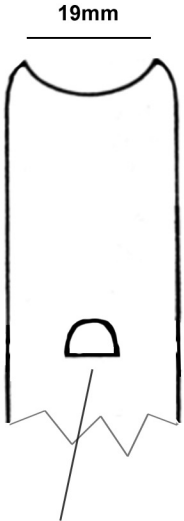

Weld a blob of steel and grind to profile using a dremel.

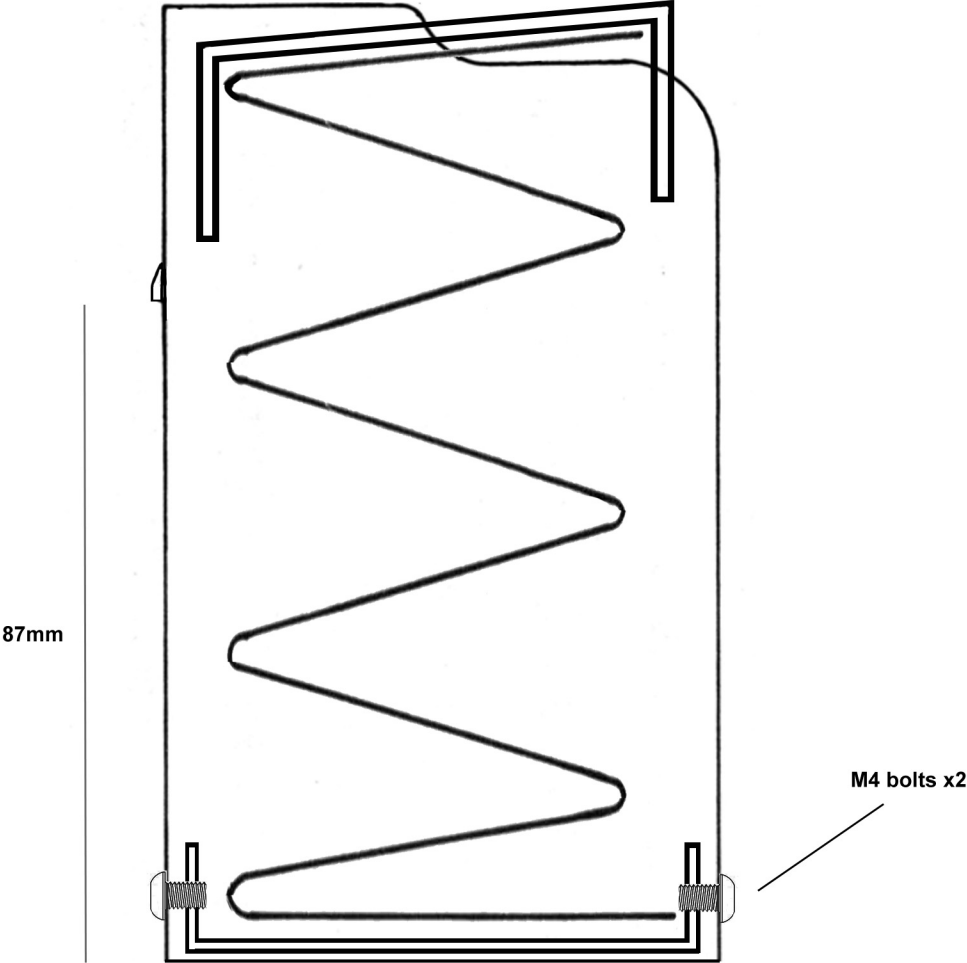

Bolt locking / unlocking sequence

When the pump forearm is fully forward the spring loaded locking lug on the bolt is free to engage with the lug slot in the top of the receiver, securely locking the bolt in place. When the pump forearm is pulled rearward the locking lug is pushed out of engagement with the locking lug hole by the action bar, enabling the bolt to travel rearward when the bolt peg makes contact with the front of the first slot in the action bar.

Bolt locked:

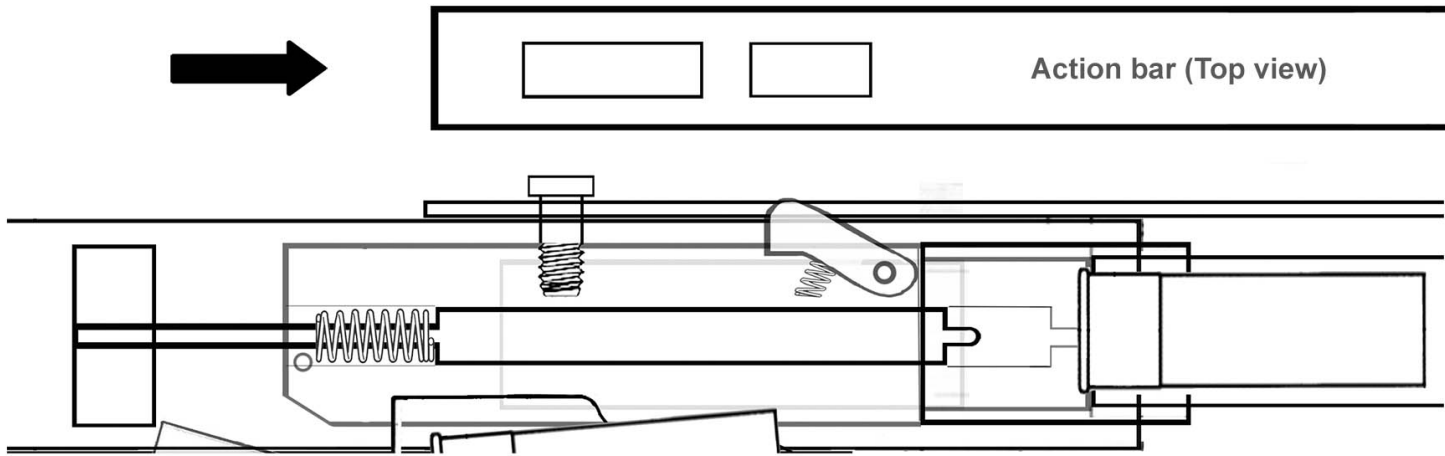

Bolt unlocked:

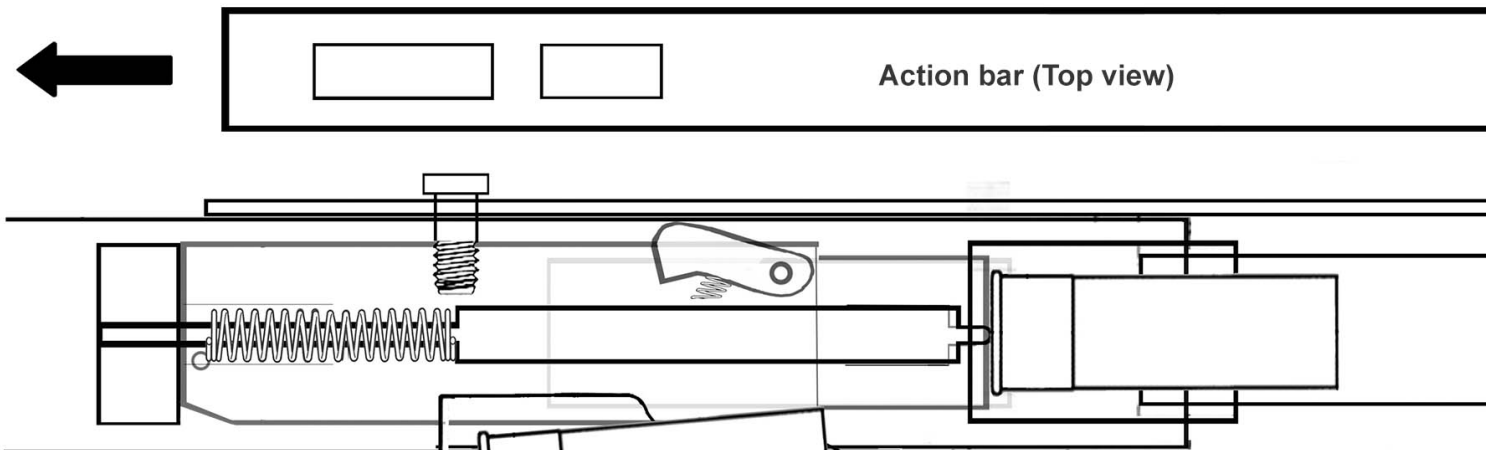

Inner bolt piece

Firing pin channel is bored through a 133mm long length of 1" (25mm) mild steel bar.

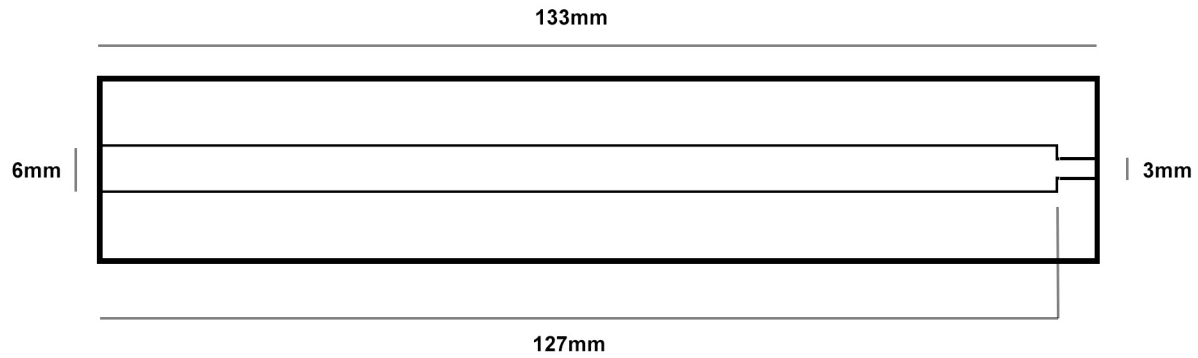

An alternative bolt construction method consisting of multiple lengths of steel tube and bar stock welded together

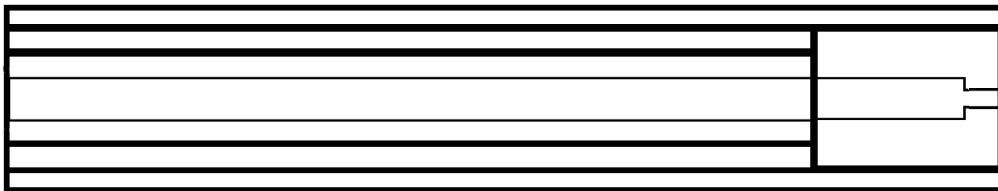

1" + 5/8" + 1/2" steel tube + 3/4" steel bar stock welded in front

2 inches

Firing pin

Turn to shape from 6mm dia steel bar stock

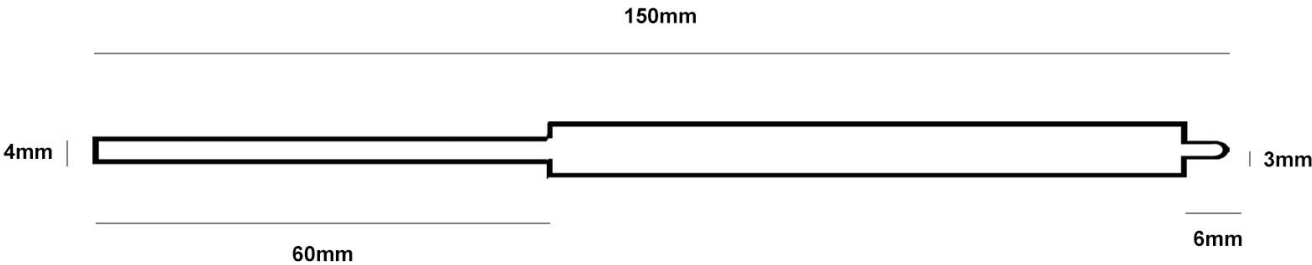

Can alternatively be constructed by sleeving a length of 4mm dia steel bar with an 84mm length of 6mm steel tubing.

Striker

30mm steel round or square bar

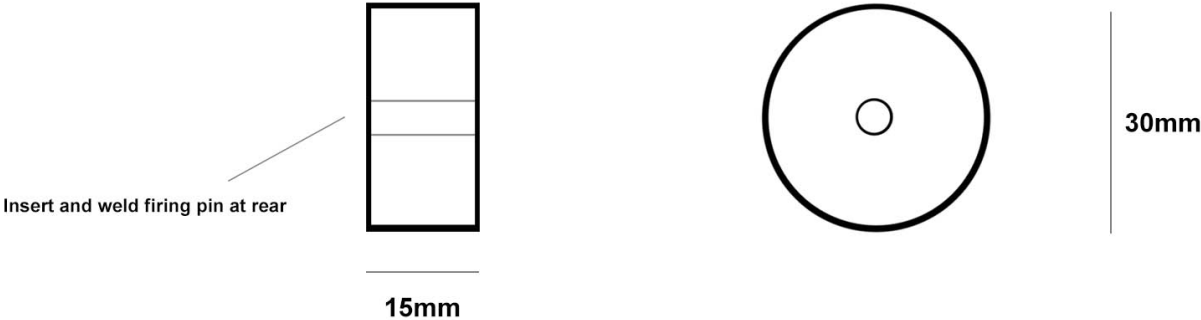

2 inches

Bolt body

30mm x 30mm x 2mm wall steel square box or round tube (1" ID)

105mm

Front

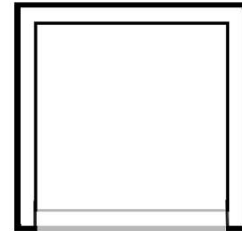

Bottom



18mm

Top

46mm

Drill 7mm and tap for M8 threads

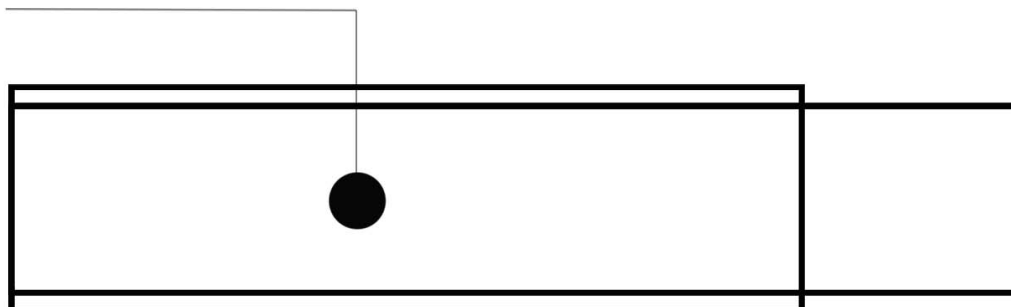

2 inches

Print on 8.5x11 US letter paper

Bolt locking lug

Cut to shape from 10mm thick steel plate or flat bar. Drill hole for 5mm dia, 30mm long pivot pin.

Template

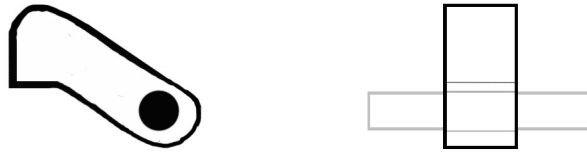

Drill a 5mm dia hole 6mm in from top and front of bolt body for lug pin. Grind out a pocket in bolt until the lug is able to pivot flush with top of bolt body.

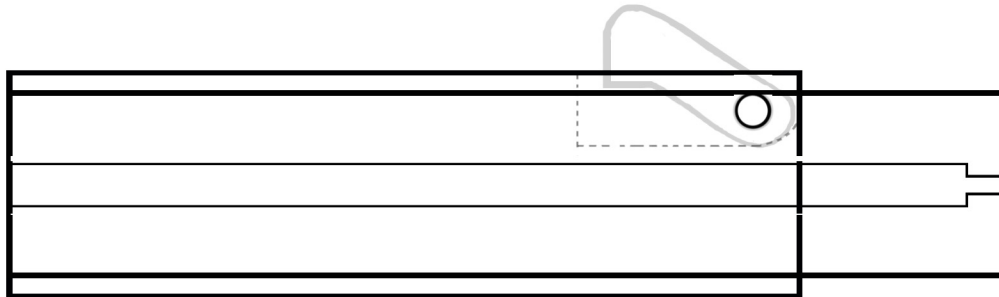

Drill a 6mm dia pocket hole in lug to accommodate a strong compression spring.

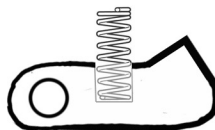

2 inches

Print on 8.5x11 US letter paper

Extractors

Cut from 2mm thick steel sheet. Harden.

Templates

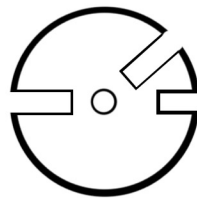

Ejector

Modify from an M6 bolt, 10mm long

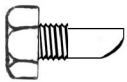

Cut ejector slot in bolt using an angle grinder fitted with a slitting disc. Slot should be 4mm wide, 7mm deep, 3" long

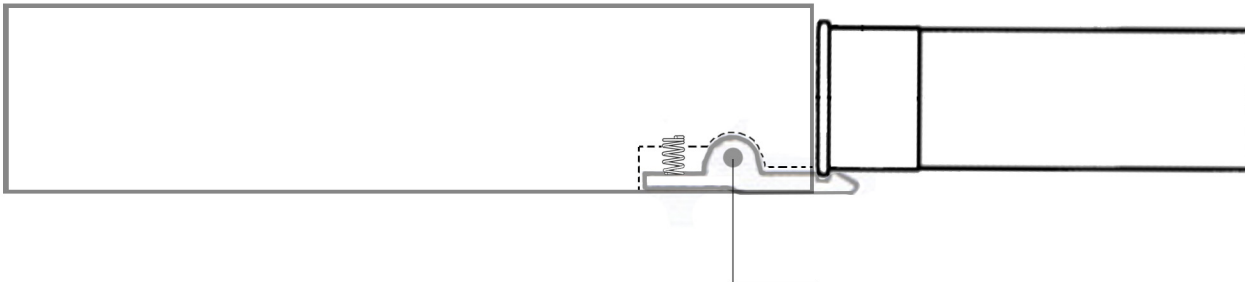

Drill 10mm from front / 4mm from sides

+ X2 4mm dia compression springs

2 inches

Print on 8.5x11 US letter paper

Bolt assembled

Side:

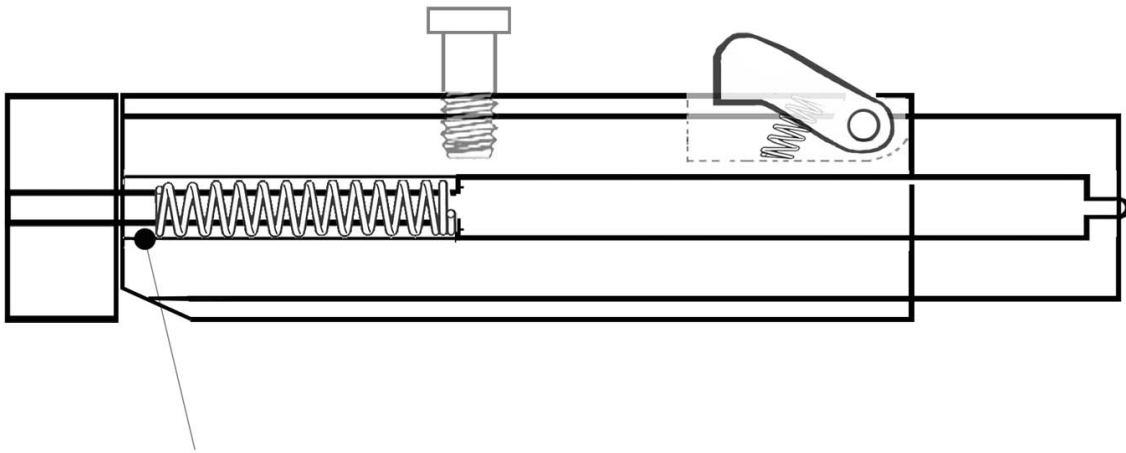

Drill a 4mm hole and insert a seloc pin to retain firing pin assembly

Front:

Bolt peg

M8 bolt - 15mm long

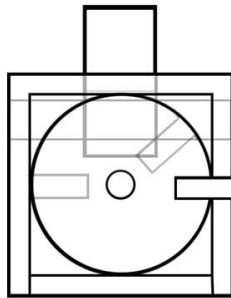
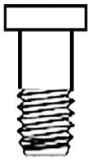

Weld bolt piece into bolt body

2 inches

Action bar

20mm wide, 2mm thick steel strip.
290mm long.

Rear end:

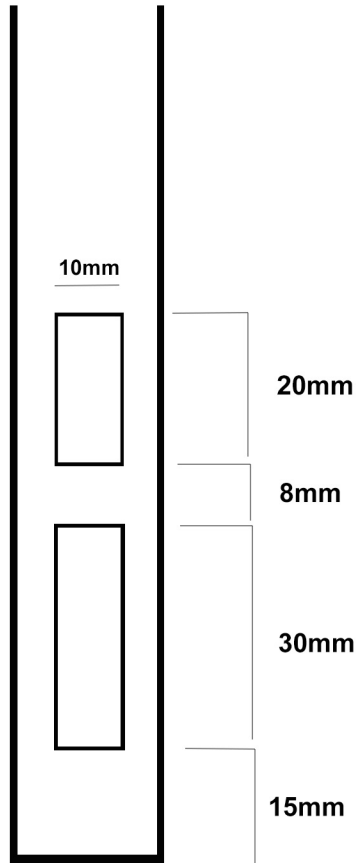

Front end:

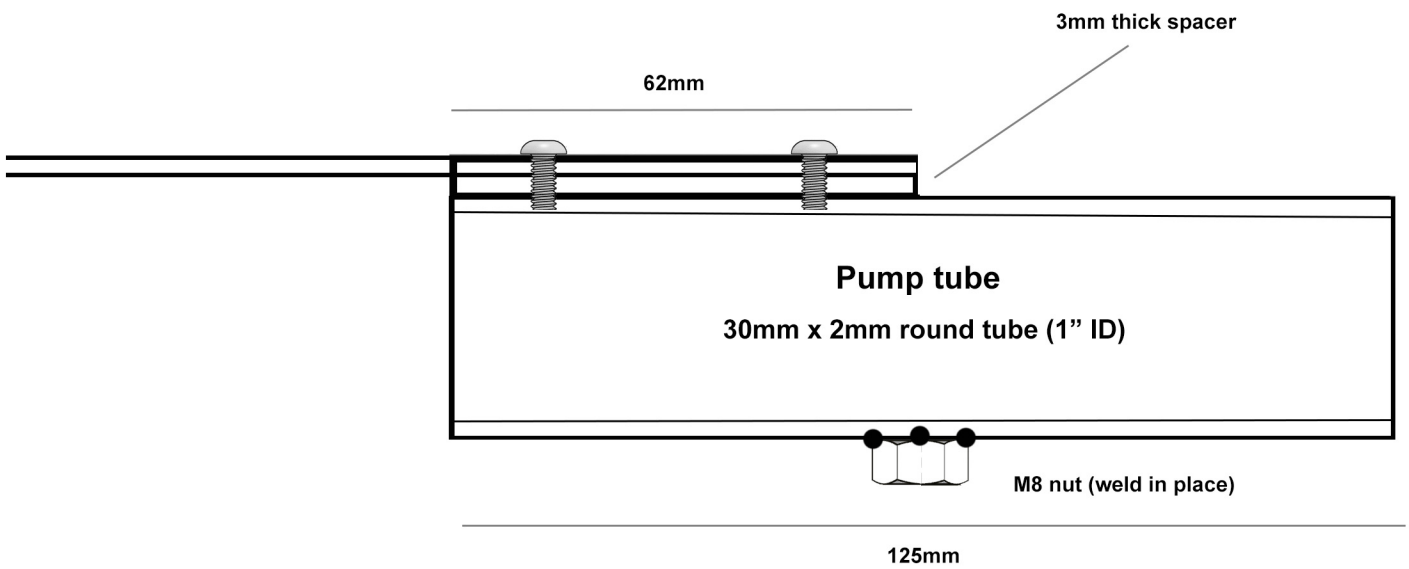

2 inches

Print on 8.5x11 US letter paper

Barrel

25mm x 2.5mm wall seamless steel tube (3/4" ID, 1" OD) - 20" long

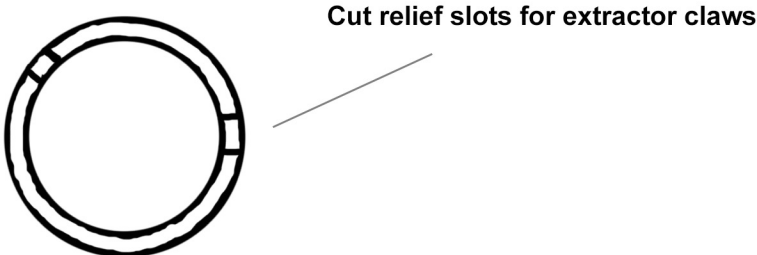

Bevel both collar and barrel entrance

Barrel collar

30mm x 2mm wall (1" ID)

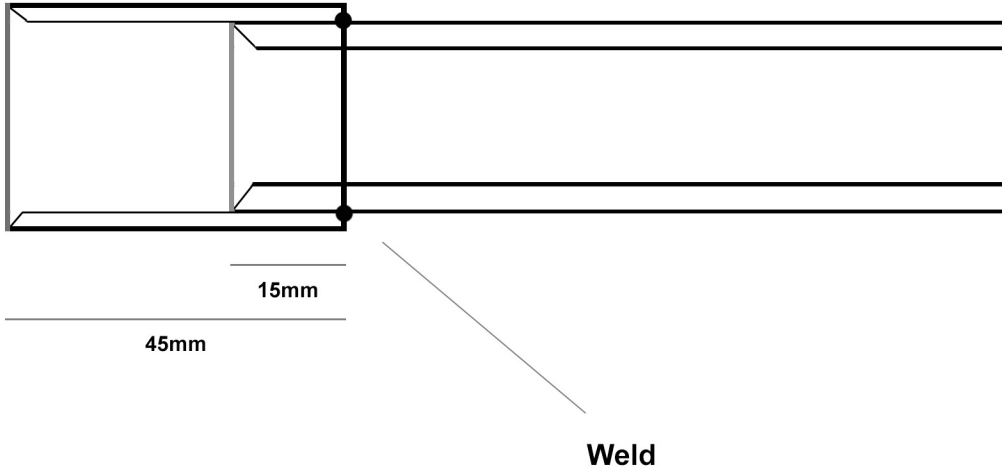

Front sight

3mm thick mild steel sheet

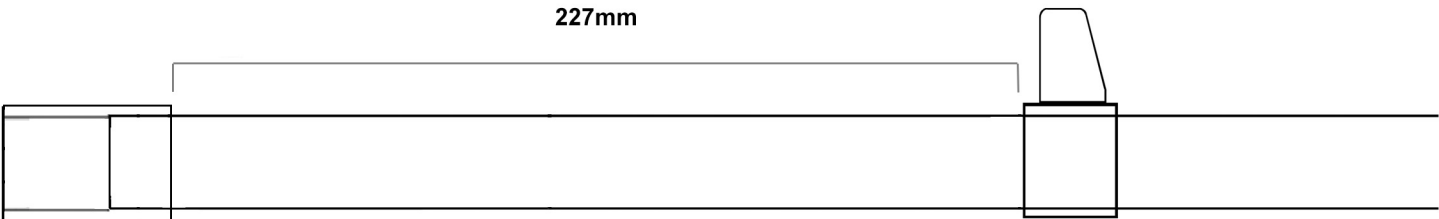
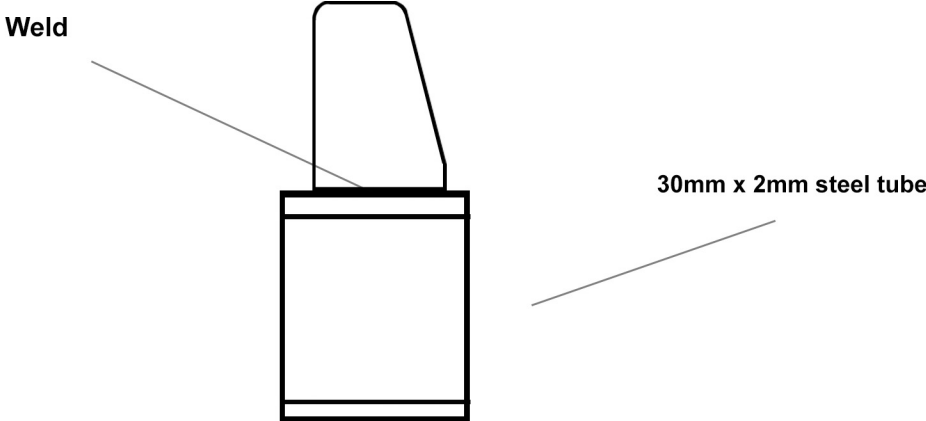
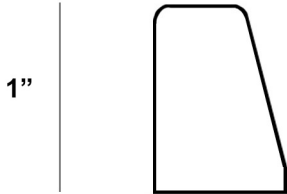

Weld front sight collar to barrel 227mm from chamber collar

2 inches

Pump forearm

2" thick hardwood or plastic

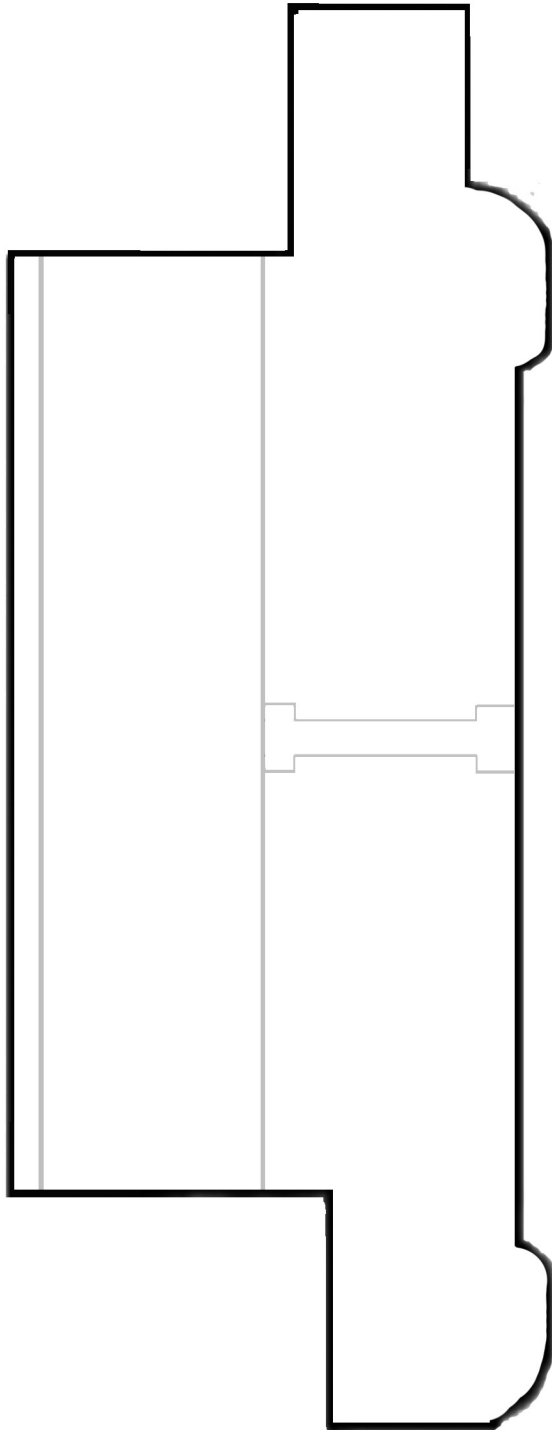

Front

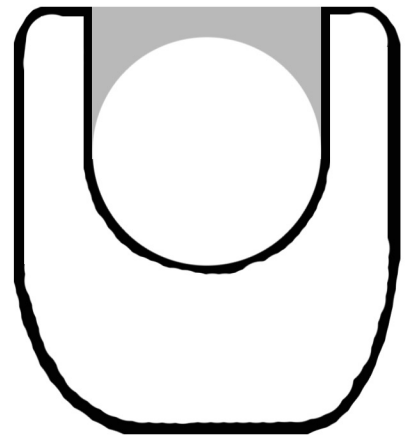

Forearm is secured to pump tube via an M8 bolt

2 inches

Print on 8.5x11 US letter paper

Pistol grip

Cut from 1 3/8" thick hardwood or plastic

Drill a 6mm dia hole to secure grip to mounting block on lower receiver using a 3" long m6 bolt

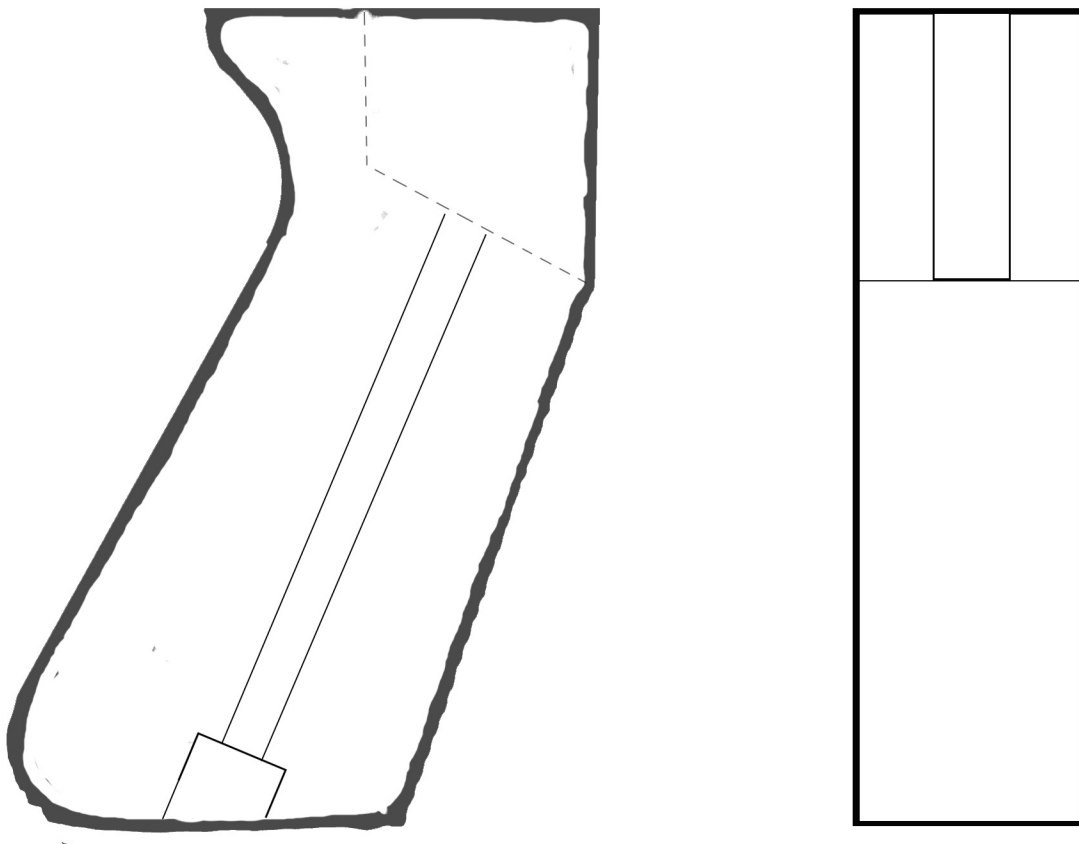

Alternatively weld in place a piece of steel plate and bolt on two grip panels either side to match the grip plate profile.

2 inches

Print on 8.5x11 US letter paper

2 inches

Print on 8.5x11 US letter paper

Stock

1.5" hardwood or plastic

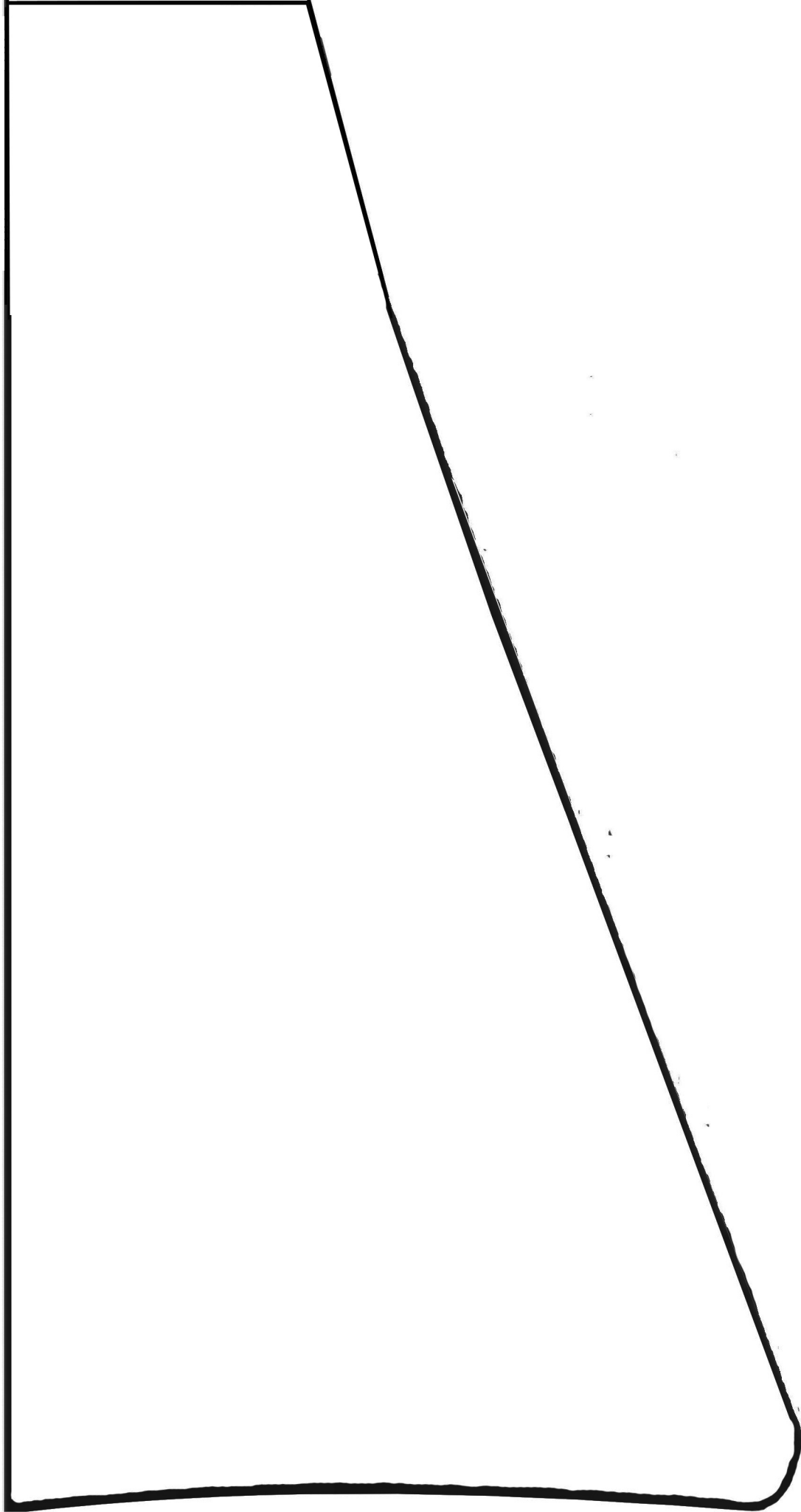

2 inches

Print on 8.5x11 US letter paper

Actual size

